



US00D645434S

(12) **United States Design Patent**  
**Cho et al.**

(10) **Patent No.:** **US D645,434 S**

(45) **Date of Patent:** **\*\* Sep. 20, 2011**

(54) **PORTABLE BLUE-RAY PLAYER**

(75) Inventors: **Ju-Won Cho**, Seoul (KR); **Chae-Joo Son**, Namyangju-si (KR)

(73) Assignee: **Samsung Electronics Co., Ltd.**,  
Maetan-dong, Yeongtong-gu, Suwon-si,  
Gyeonggi-do (KR)

(\*\*) Term: **14 Years**

(21) Appl. No.: **29/359,189**

(22) Filed: **Apr. 7, 2010**

(51) **LOC (9) Cl.** ..... **14-03**

(52) **U.S. Cl.** ..... **D14/132**

(58) **Field of Classification Search** ..... D14/125-134,  
D14/239, 371, 136, 374-377, 440, 450, 448,  
D14/336, 342; 312/7.2; 348/836, 838, 180,  
348/184, 325, 739; 341/12; 248/917-924,  
248/465; 345/104, 133, 156, 168, 87, 173;  
720/605, 669, 600, 655; 369/99, 197; D21/329,  
D21/515, 577, 622, 333, 433, 448, 452, 450,  
D21/331; D6/477, 479, 300; 273/148 B;  
446/484, 175, 356; D10/15, 26

See application file for complete search history.

(56) **References Cited**

**U.S. PATENT DOCUMENTS**

D445,100 S \* 7/2001 Sawai ..... D14/501  
D447,738 S \* 9/2001 Usami et al. .... D14/501

D501,452 S \* 2/2005 Peng ..... D14/129  
D501,835 S \* 2/2005 Peng ..... D14/129  
D534,513 S \* 1/2007 Peng ..... D14/132  
D542,751 S \* 5/2007 Guo et al. .... D14/132  
D552,052 S \* 10/2007 Liang et al. .... D14/132  
D568,271 S \* 5/2008 Lee ..... D14/132  
D606,504 S \* 12/2009 Lee ..... D14/132

\* cited by examiner

*Primary Examiner* — Raphael Barkai

(74) *Attorney, Agent, or Firm* — Lexyoume IP Group,  
PLLC.

(57) **CLAIM**

The ornamental design for a portable blue-ray player, as shown and described.

**DESCRIPTION**

FIG. 1 is a perspective view of a portable blue-ray player showing our new design;  
FIG. 2 is a front elevational view thereof;  
FIG. 3 is a rear elevational view thereof;  
FIG. 4 is a left side elevational view thereof;  
FIG. 5 is a right side elevational view thereof;  
FIG. 6 is a top plan view thereof;  
FIG. 7 is a bottom plan view thereof; and,  
FIG. 8 is a perspective view of the portable blue-ray player showing our new design in a state in which the portable blue-ray player is open when used.  
The broken lines in the drawings are for illustrative purpose only and form no part of the claimed design.

**1 Claim, 8 Drawing Sheets**

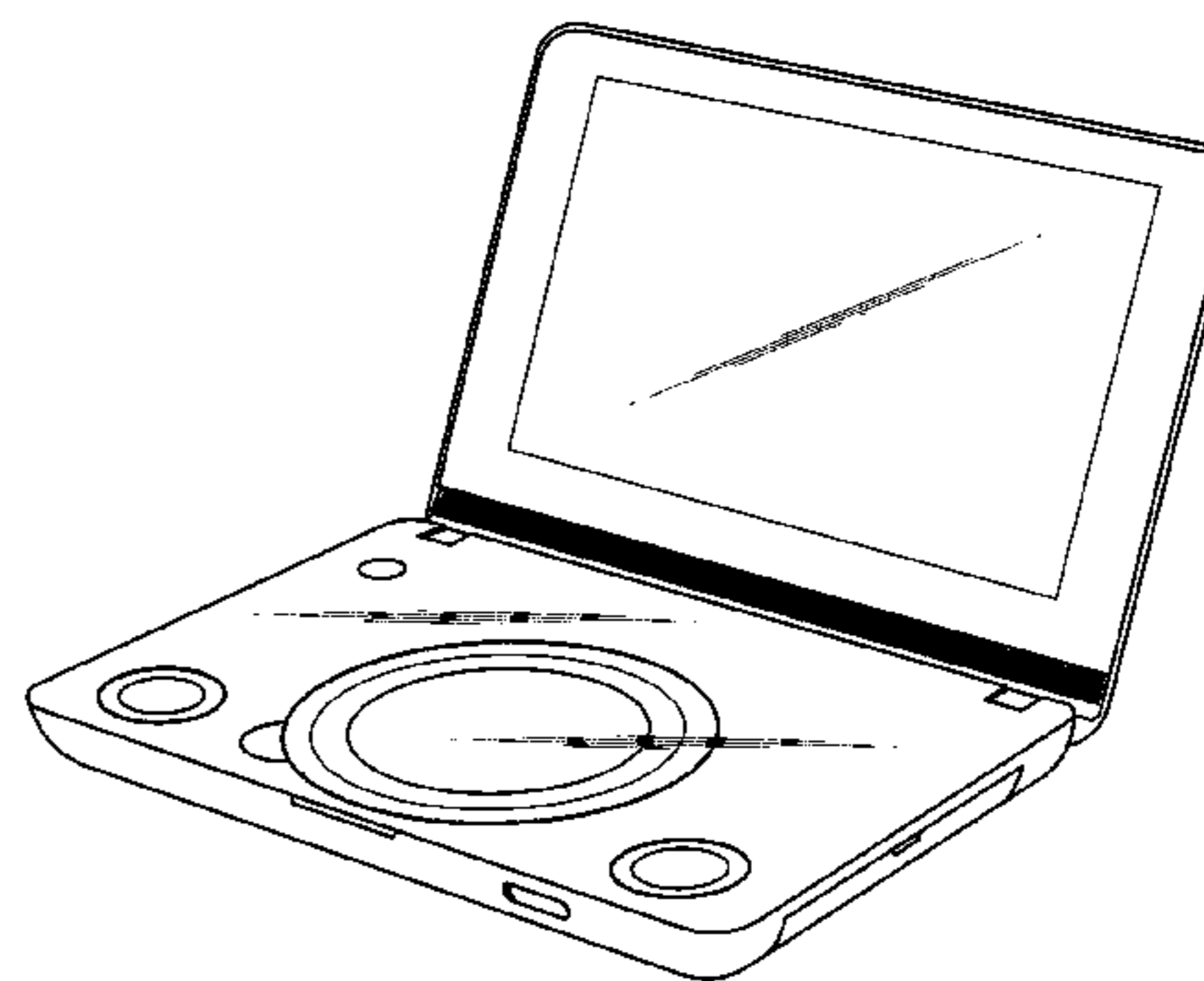
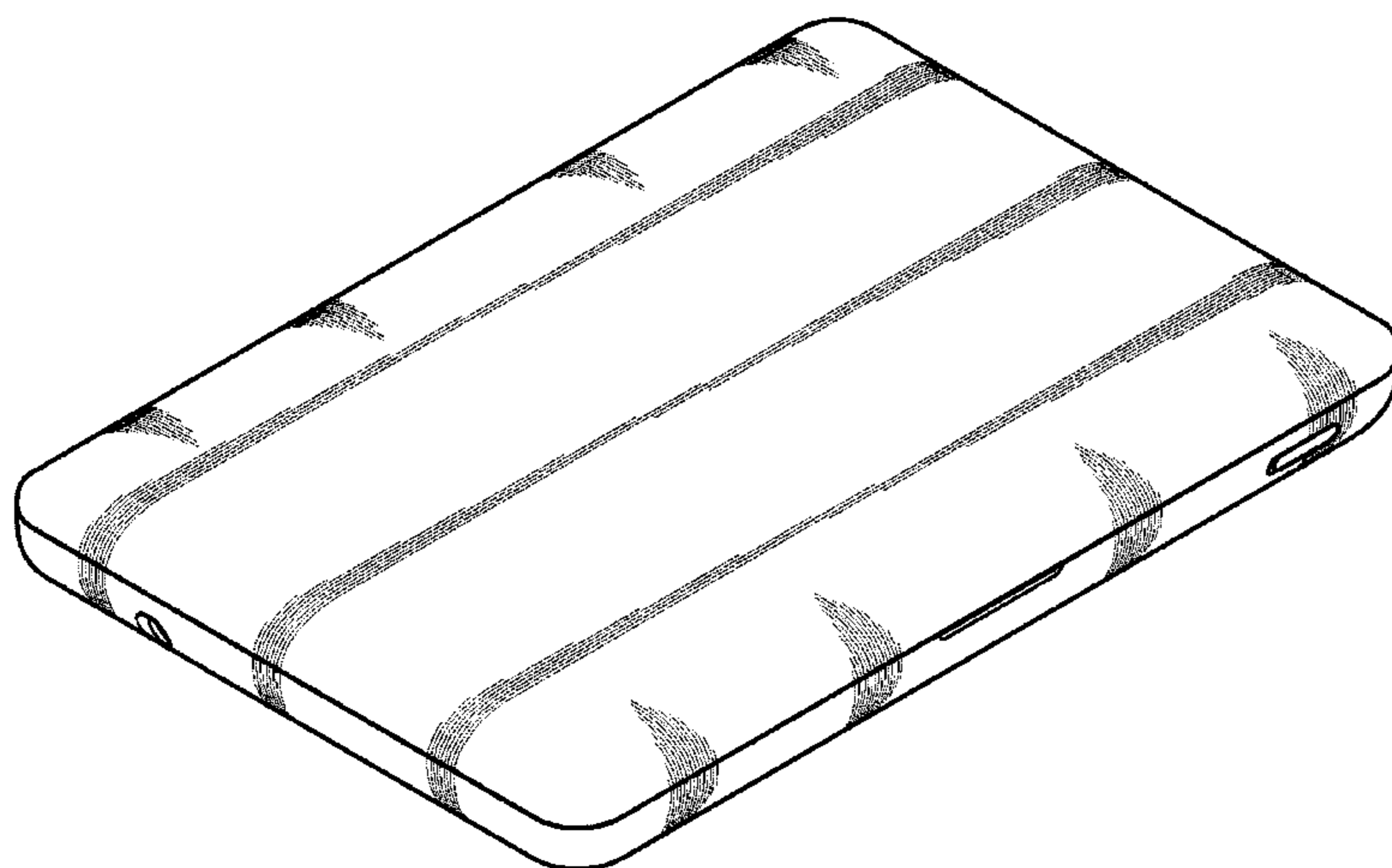

FIG. 1

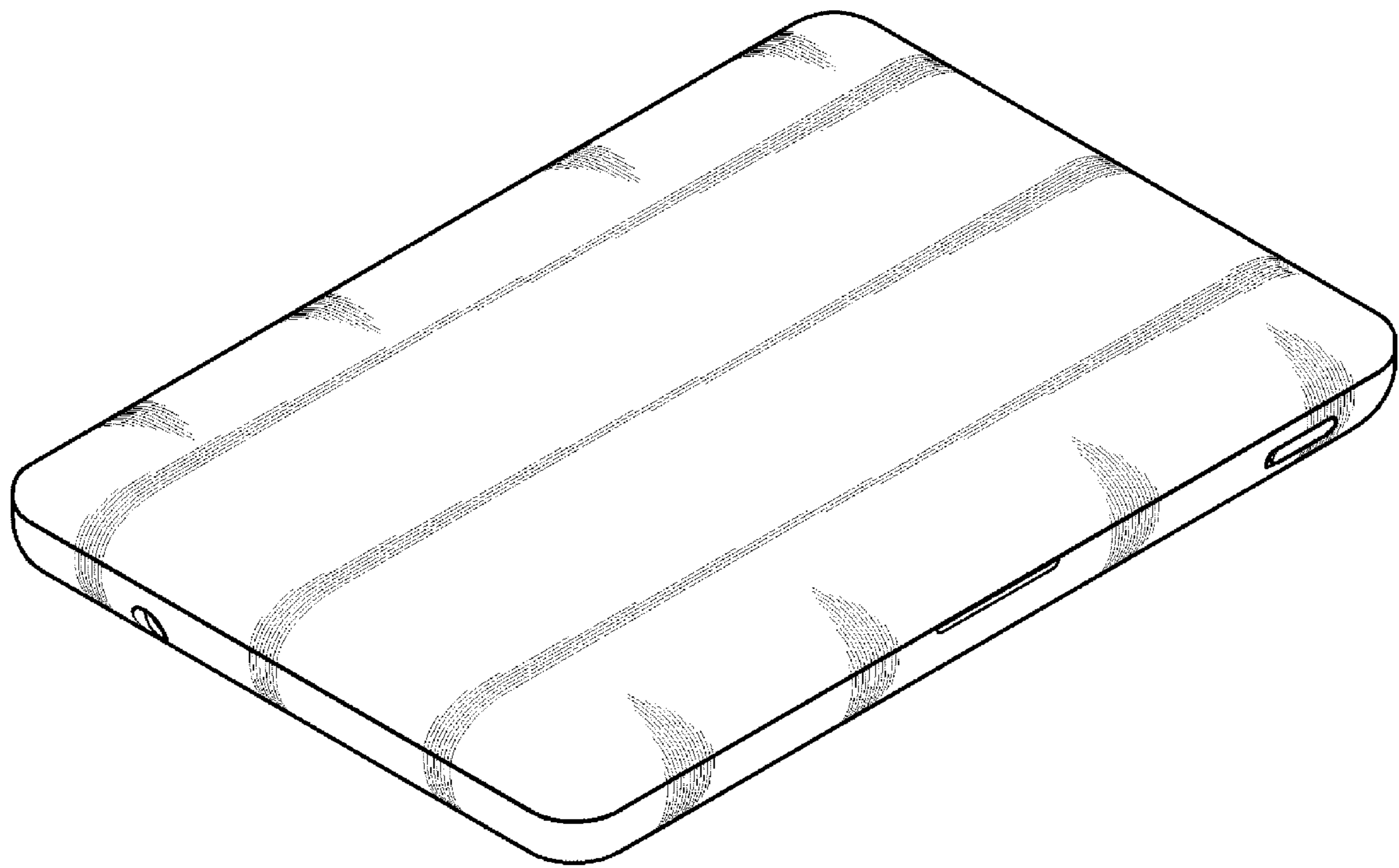

FIG. 2



FIG. 3

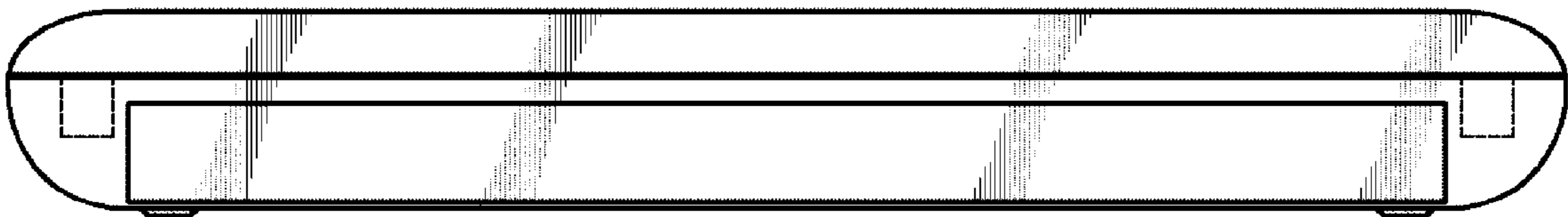

FIG. 4

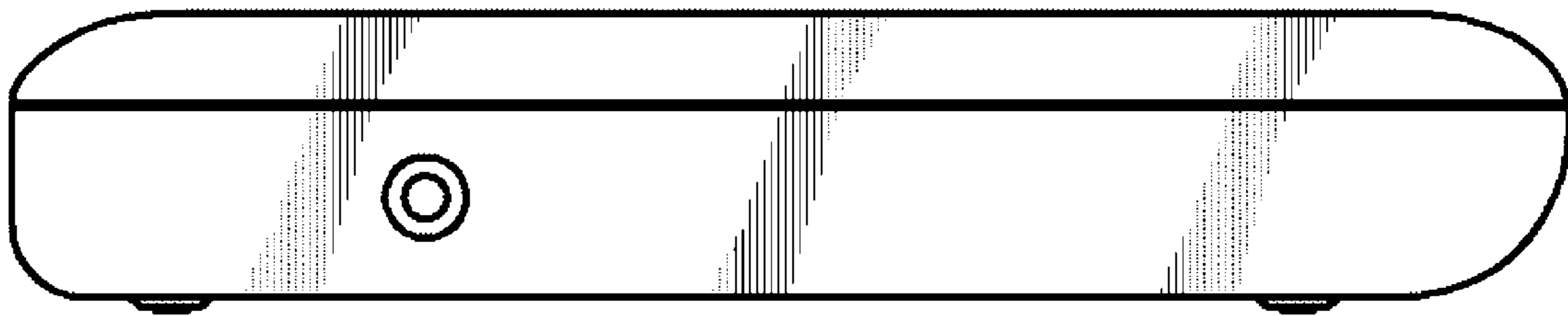

FIG. 5

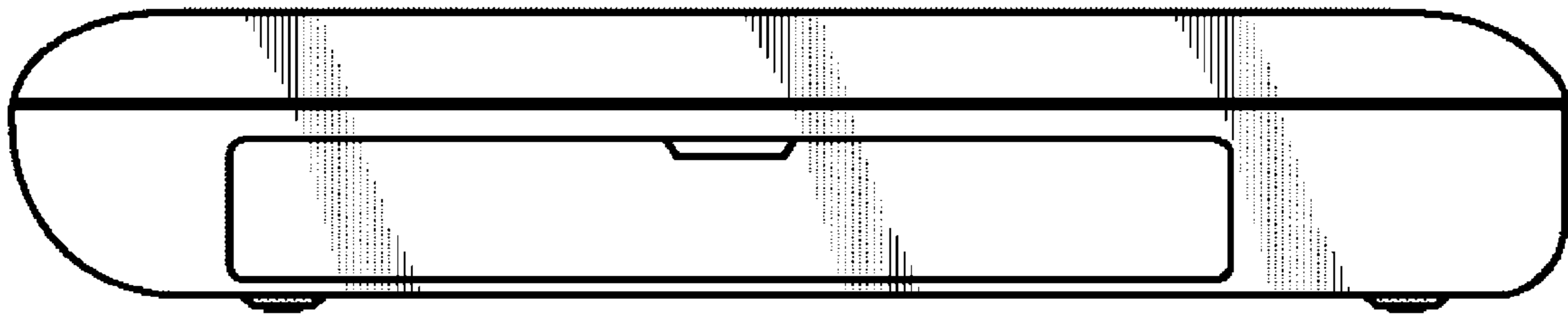

FIG. 6

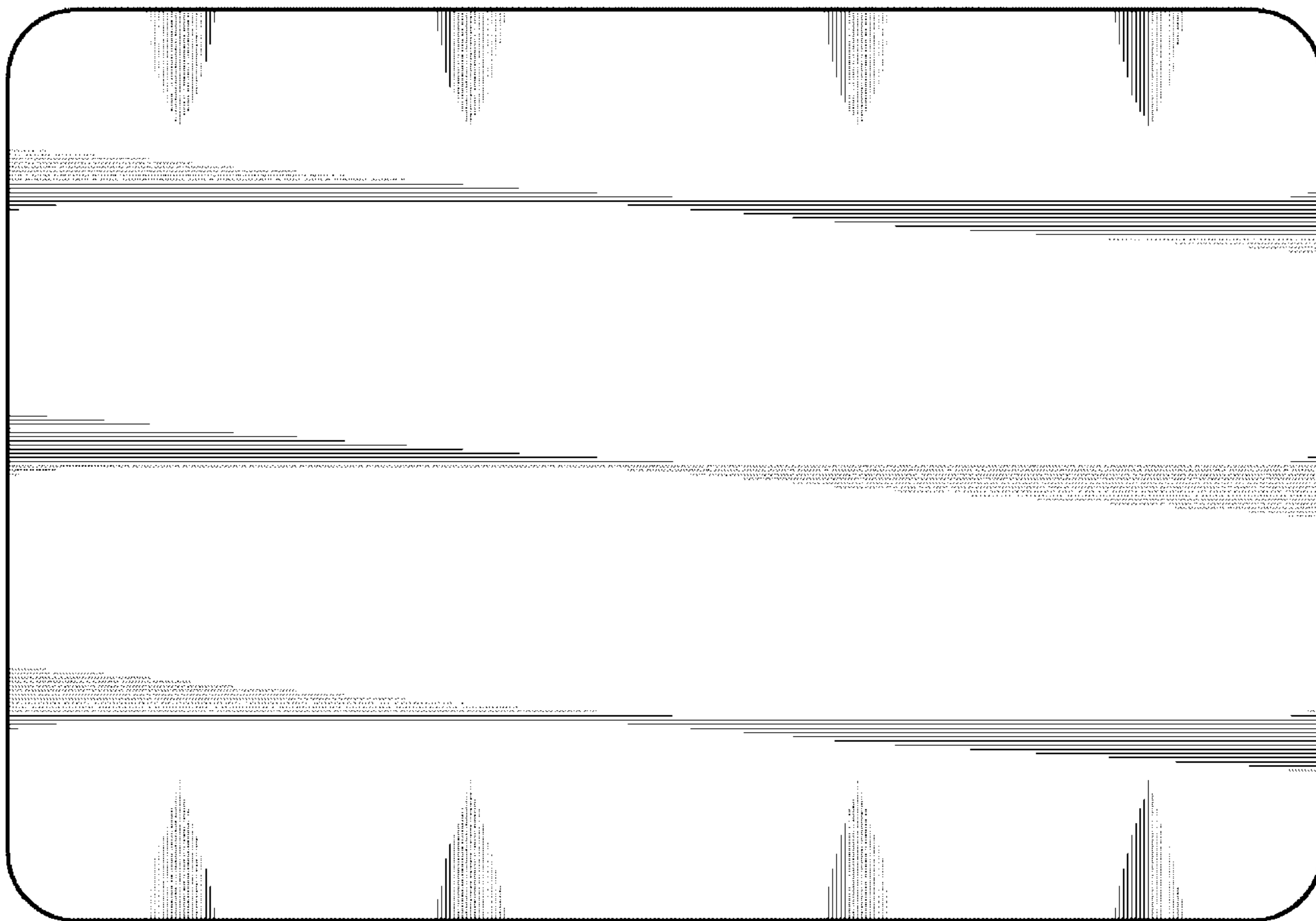

FIG. 7

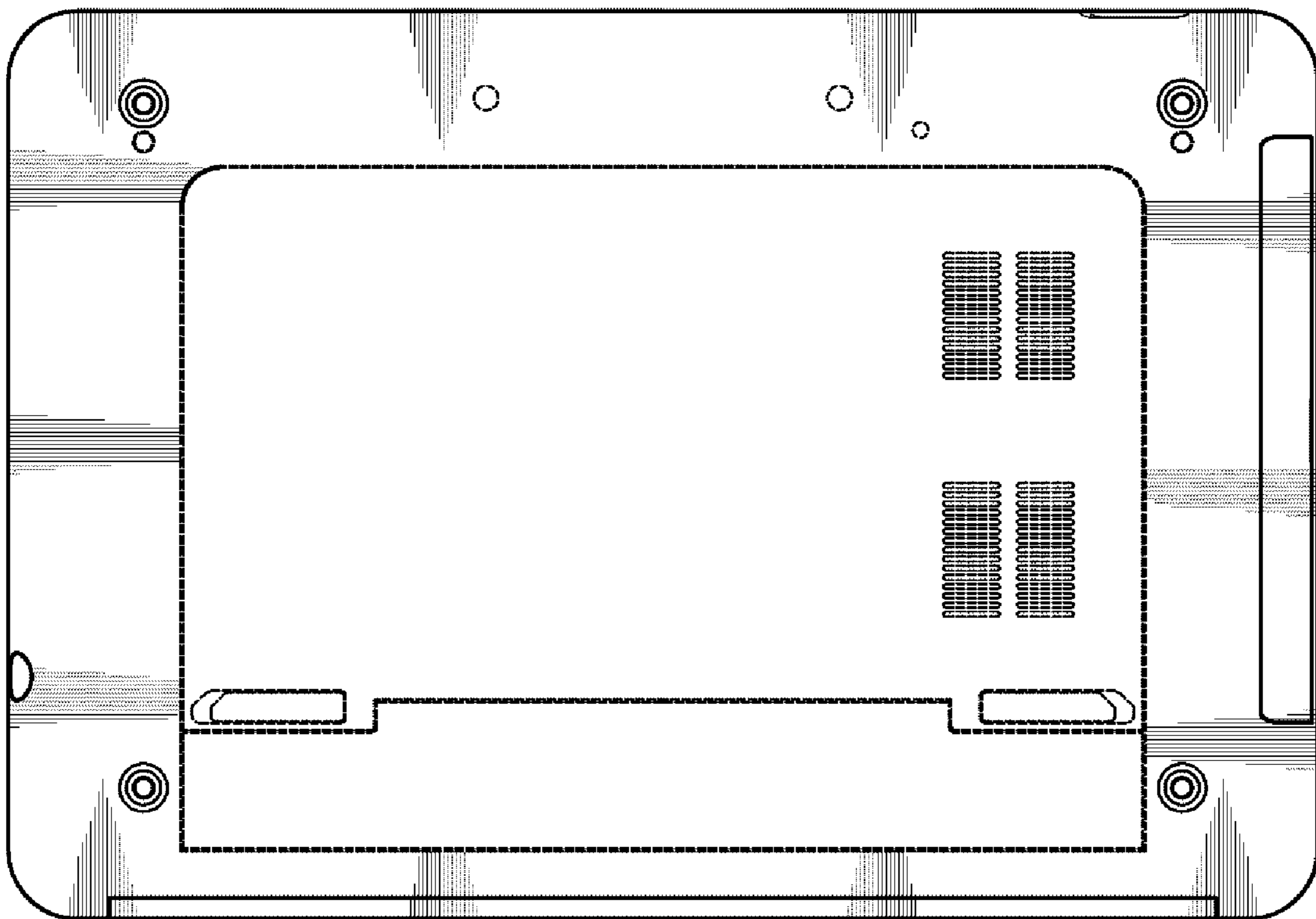



FIG. 8

