



US00D645350S

(12) **United States Design Patent**
Degeyter et al.

(10) **Patent No.:** **US D645,350 S**

(45) **Date of Patent:** **** Sep. 20, 2011**

(54) **BOTTLE WITH DOSER**

(75) Inventors: **Raf Gustaaf Alfons Degeyter**, Donk (BE); **Guy Hubert Stephane Sylvain Culeron**, St. Genesius (BE); **Marcus Jozef Theresia Buck**, Antwerp (BE); **Leen Solange Werner Pattyn**, Ghent (BE)

(73) Assignee: **The Procter & Gamble Company**, Cincinnati, OH (US)

(**) Term: **14 Years**

(21) Appl. No.: **29/383,749**

(22) Filed: **Jan. 21, 2011**

(51) **LOC (9) Cl.** **09-07**

(52) **U.S. Cl.** **D9/454**

(58) **Field of Classification Search** D9/780,
D9/772, 529, 504, 503, 454, 452, 445, 444,
D9/443, 440, 435, 429, 428, 427; D7/392.1,
D7/391, 354; D28/7; D24/222, 115; D23/366;
428/34.1; 229/123.1; 220/270, 266; 215/316,
215/253, 250

See application file for complete search history.

(56) **References Cited**

U.S. PATENT DOCUMENTS

D111,450 S * 9/1938 Windbiel D9/452
5,899,361 A * 5/1999 Durliat et al. 222/92

D471,086 S * 3/2003 Helleu D9/694
D476,573 S * 7/2003 Diete D9/529
D525,526 S * 7/2006 Abbott et al. D9/449
D526,204 S * 8/2006 Stolle D9/529
D532,309 S * 11/2006 Stolle D9/529
D573,887 S * 7/2008 Bouroullec et al. D9/529
D589,368 S * 3/2009 Abolfazlian D9/772
D589,794 S * 4/2009 Branson et al. D9/435
D607,334 S * 1/2010 Domoy et al. D9/529
D617,210 S * 6/2010 Abolfazlian et al. D9/772
D620,368 S * 7/2010 Pedersen D9/529

* cited by examiner

Primary Examiner — Susan Bennett Hattan

(74) *Attorney, Agent, or Firm* — Andrew J. Mueller;
Marianne Dressman; Leonard W. Lewis

(57) **CLAIM**

The ornamental design for bottle with doser, as shown and described.

DESCRIPTION

FIG. 1 is an isometric view of a doser for a bottle, embodying the new design;
FIG. 2 is a left view thereof;
FIG. 3 is a right thereof;
FIG. 4 is a front view thereof;
FIG. 5 is a back view thereof;
FIG. 6 is a top view thereof; and,
FIG. 7 is a bottom view thereof.

1 Claim, 7 Drawing Sheets

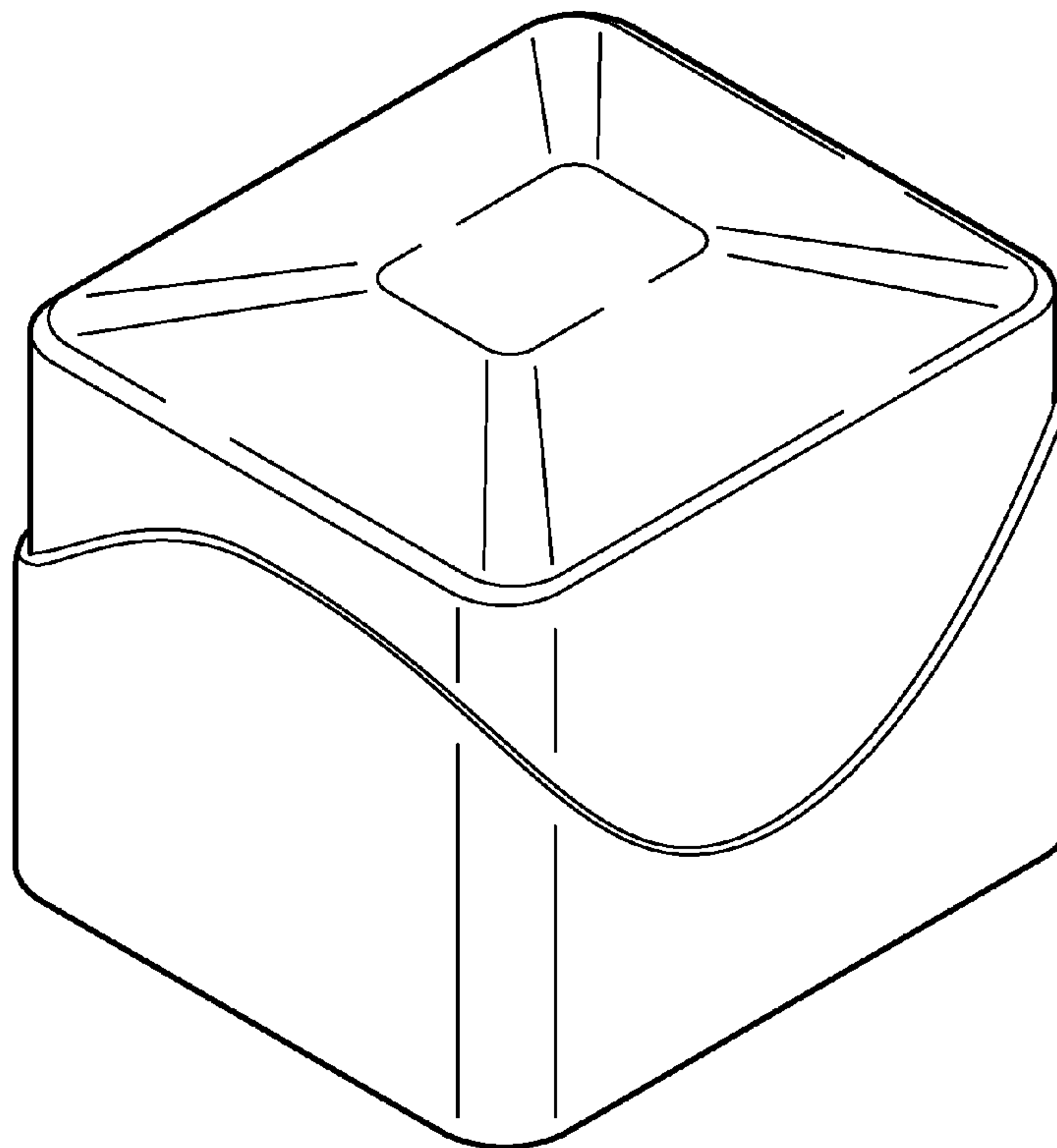

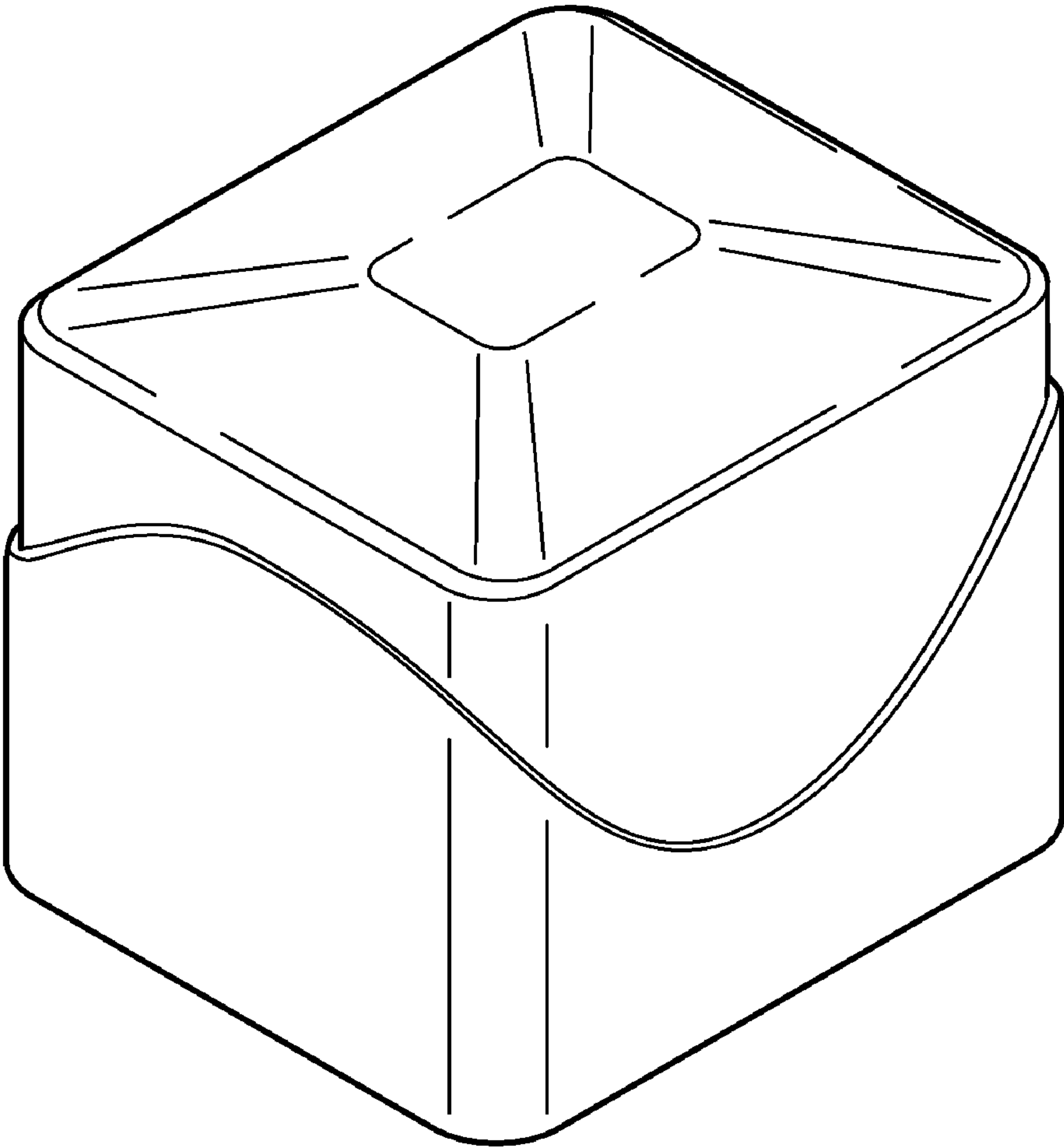

FIG. 1

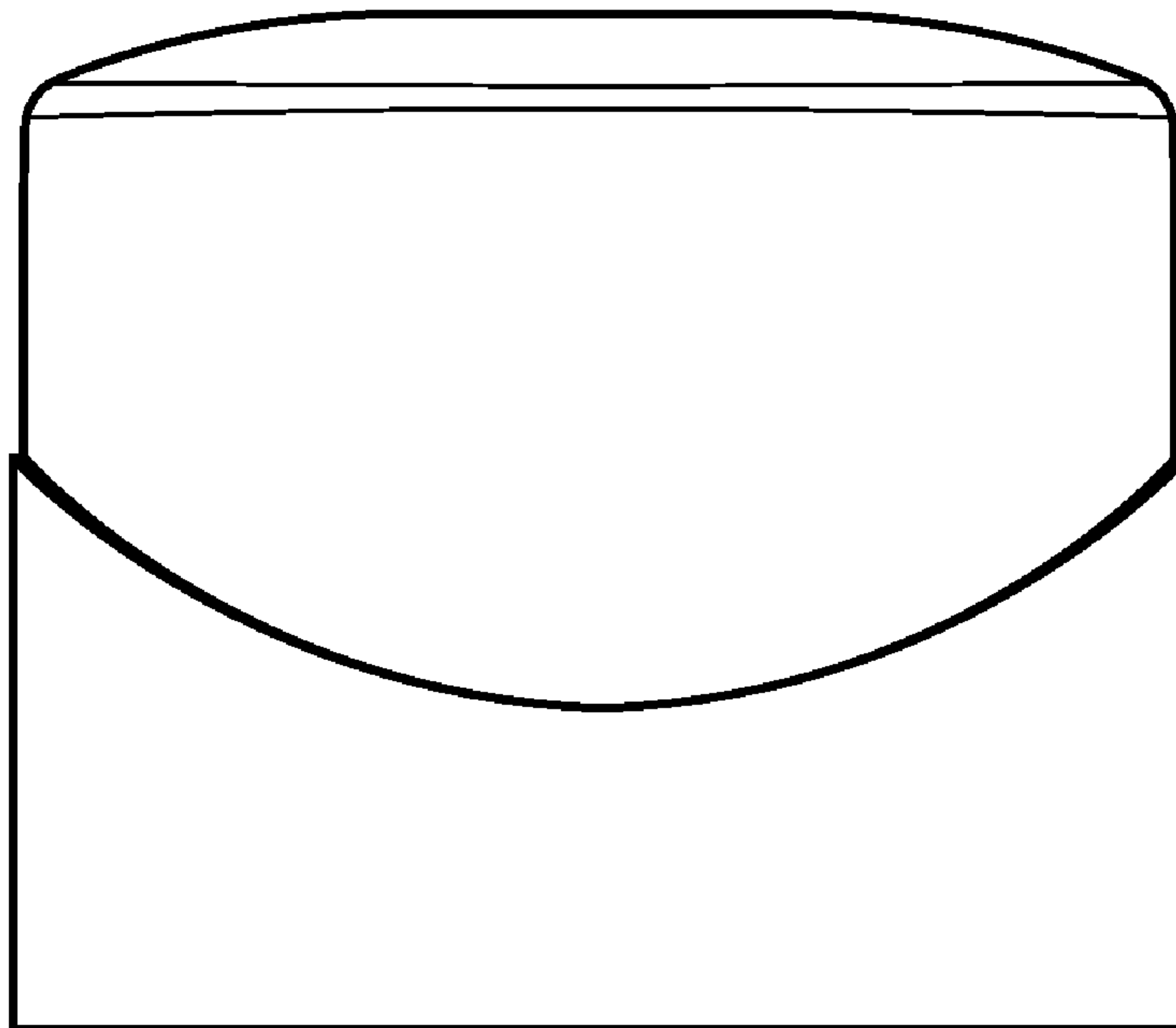

FIG. 2

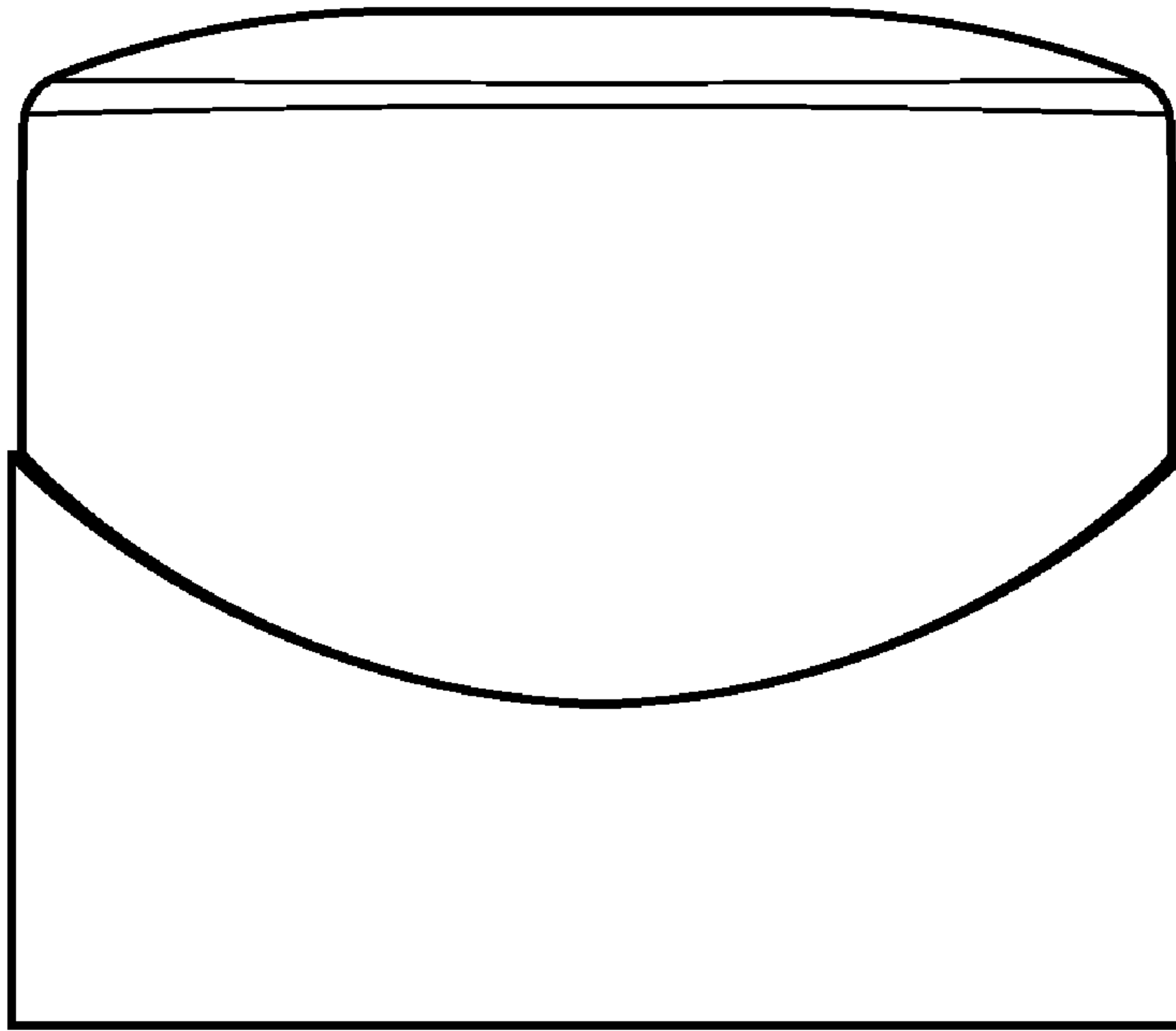

FIG. 3

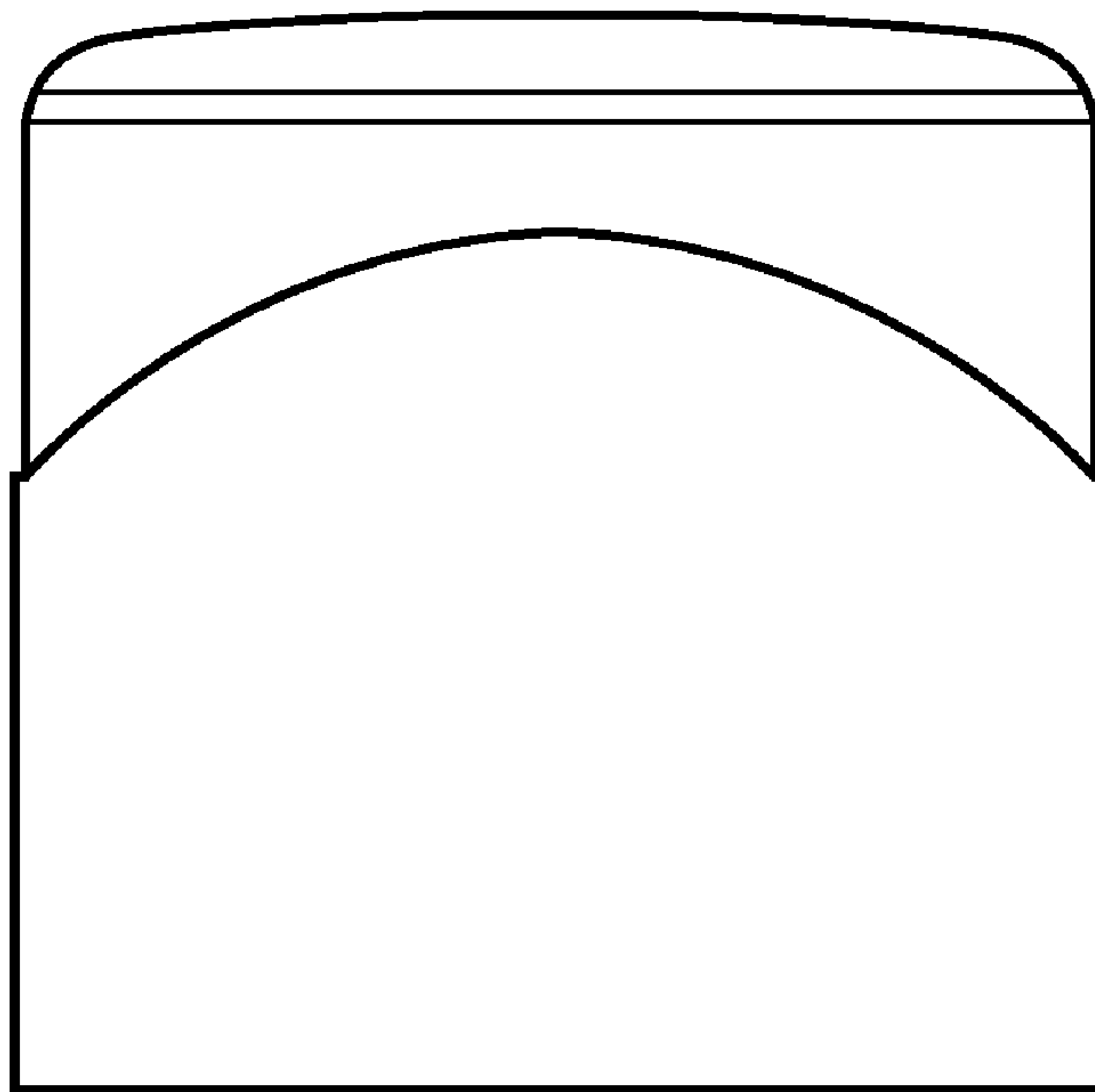

FIG. 4

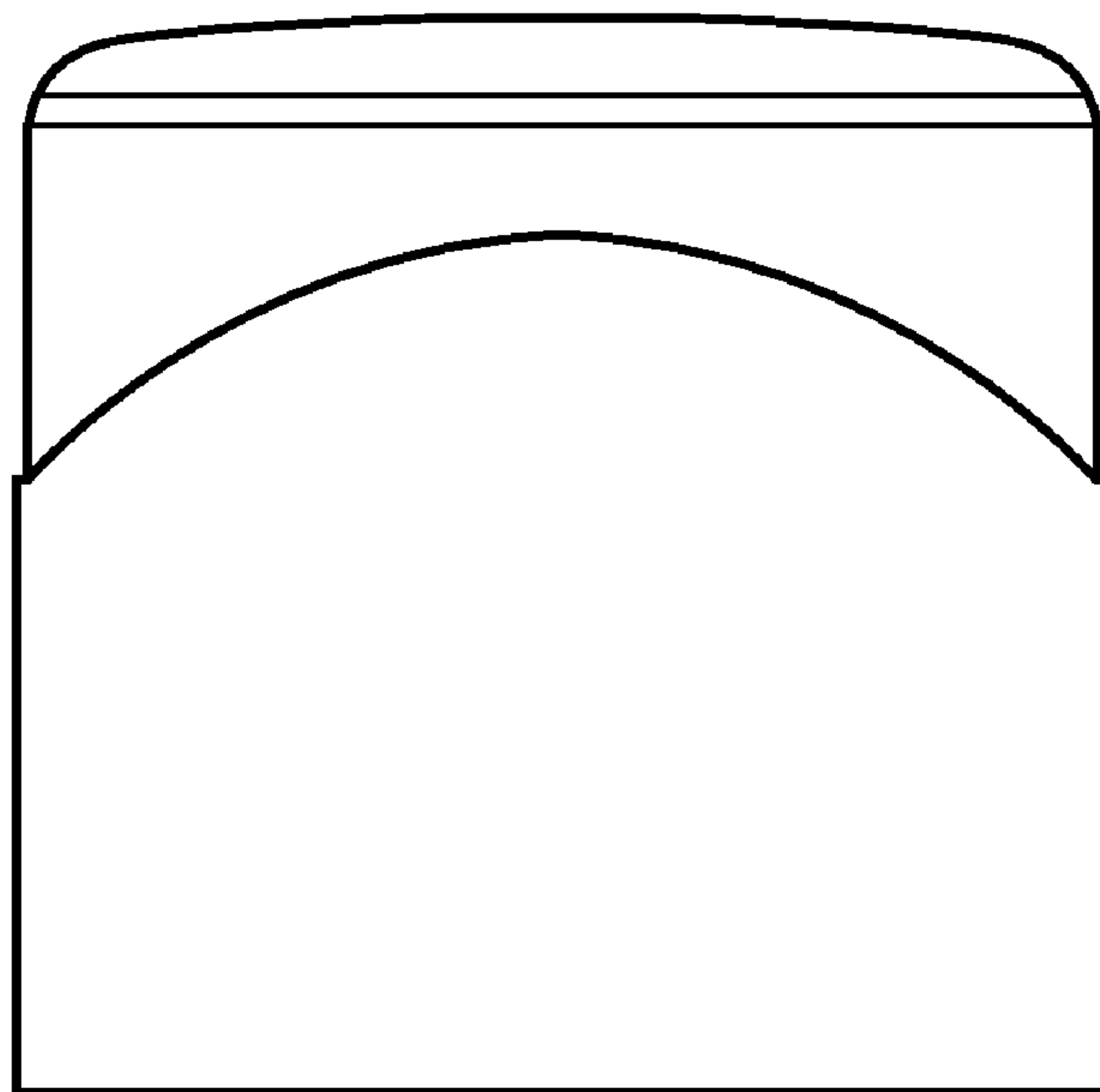

FIG. 5

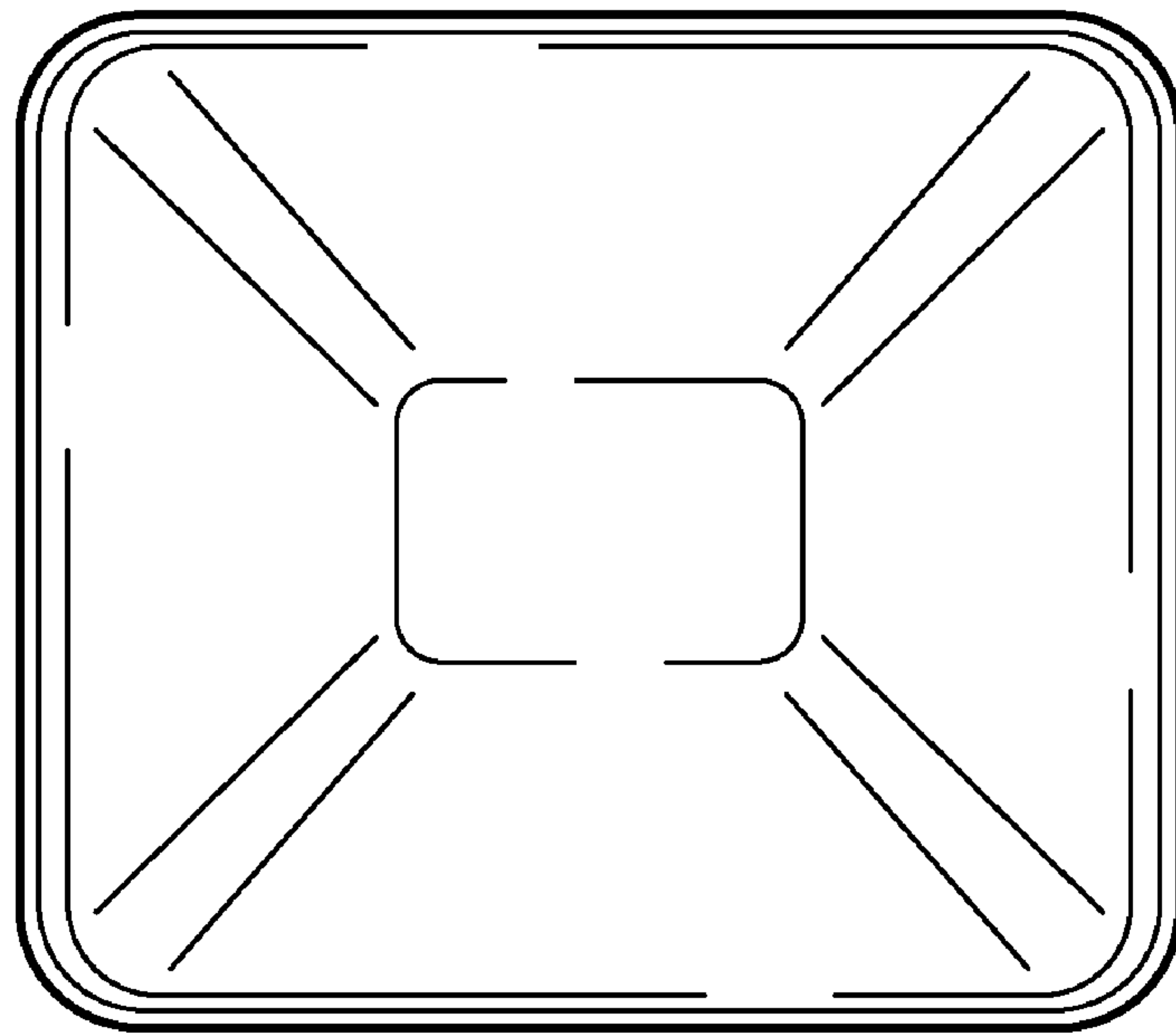

FIG. 6

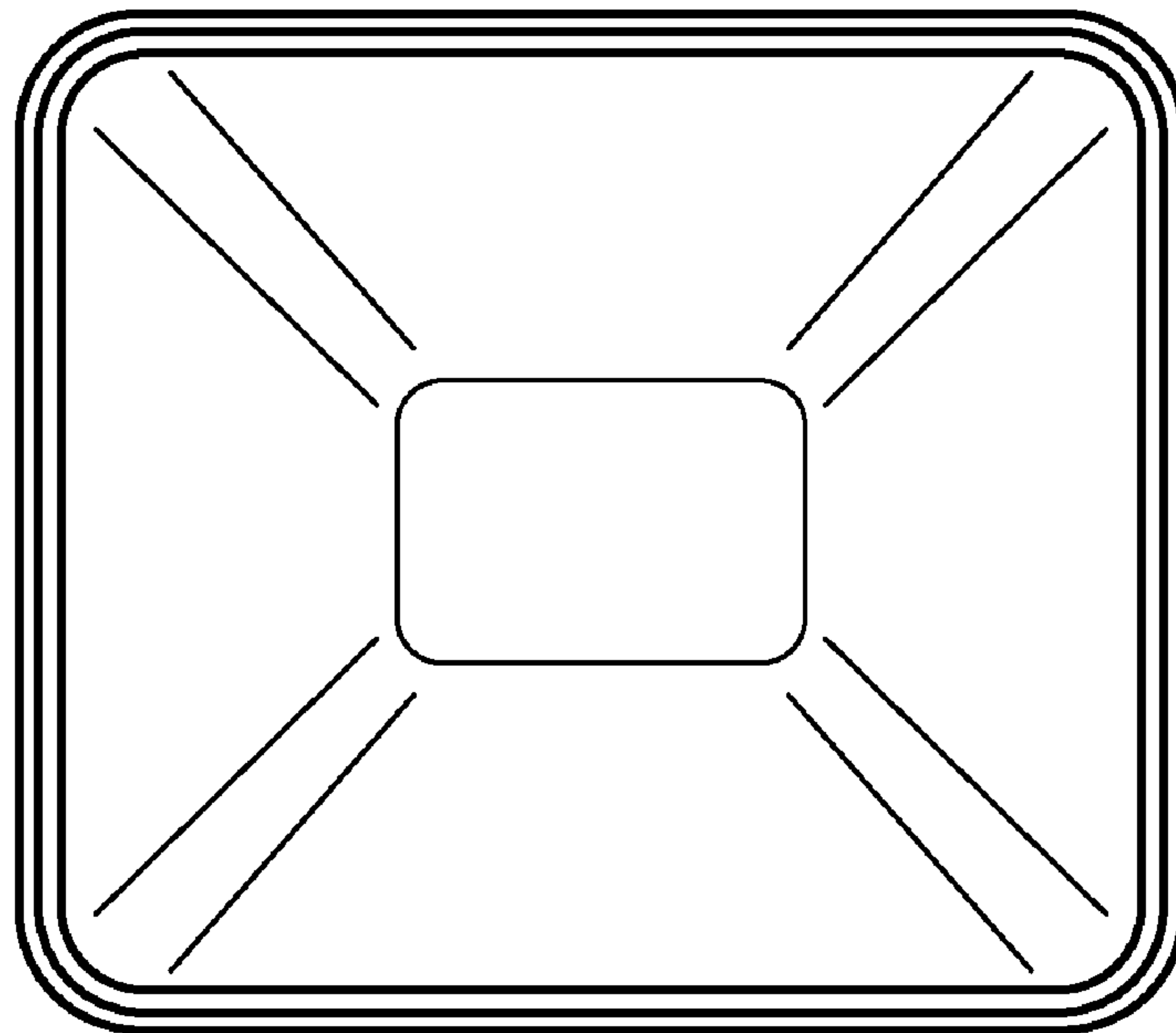

FIG. 7