



US00D645348S

(12) **United States Design Patent**
Borghesi et al.

(10) **Patent No.:** **US D645,348 S**

(45) **Date of Patent:** **** Sep. 20, 2011**

(54) **AEROSOL CAP**

(75) Inventors: **Paolo Borghesi**, Slough (GB); **Peter Kay**, Warwick (GB); **Dai Sanders**, Warwick (GB); **Ben Wilson**, Slough (GB)

(73) Assignee: **Reckitt & Colman (Overseas) Limited**, Berkshire (GB)

(**) Term: **14 Years**

(21) Appl. No.: **29/351,822**

(22) Filed: **Dec. 11, 2009**

(30) **Foreign Application Priority Data**

Jun. 11, 2009 (EM) 001145437-0001/2/3

(51) **LOC (9) Cl.** **09-01**

(52) **U.S. Cl.** **D9/445**

(58) **Field of Classification Search** D9/780,
D9/772, 529, 504, 503, 454, 452, 445, 444,
D9/443, 440, 435, 429, 428, 427; D7/392.1,
D7/391, 354; D28/7; D24/222, 115; D23/366;
428/34.1; 229/123.1; 220/270, 266; 215/316,
215/253, 250

See application file for complete search history.

(56) **References Cited**

U.S. PATENT DOCUMENTS

D288,663 S * 3/1987 Thieffry D9/452
(Continued)

Primary Examiner — Susan Bennett Hattan

(74) *Attorney, Agent, or Firm* — Norris, McLaughlin & Marcus, P.A.

(57) **CLAIM**

The ornamental design for an aerosol cap, as shown and described.

DESCRIPTION

FIG. 1 is a front perspective view of a first embodiment of our aerosol cap;

FIG. 2 is a front elevational view of the first embodiment thereof;

FIG. 3 is a rear elevational view of the first embodiment thereof;

FIG. 4 is a left side elevational view of the first embodiment thereof;

FIG. 5 is a right side elevational view of the first embodiment thereof;

FIG. 6 is a top plan view of the first embodiment thereof;

FIG. 7 is a bottom plan view of the first embodiment thereof;

FIG. 8 is a front perspective view of a second embodiment of our aerosol cap;

FIG. 9 is a front elevational view of the second embodiment thereof;

FIG. 10 is a rear elevational view of the second embodiment thereof;

FIG. 11 is a left side elevational view of the second embodiment thereof;

FIG. 12 is a right side elevational view of the second embodiment thereof;

FIG. 13 is a top plan view of the second embodiment thereof;

FIG. 14 is a bottom plan view of the second embodiment thereof;

FIG. 15 is a front perspective view of a third embodiment of our aerosol cap;

FIG. 16 is a front elevational view of the third embodiment thereof;

FIG. 17 is a rear elevational view of the third embodiment thereof;

FIG. 18 is a left side elevational view of the third embodiment thereof;

FIG. 19 is a right side elevational view of the third embodiment thereof;

FIG. 20 is a top plan view of the third embodiment thereof;

FIG. 21 is a bottom plan view of the third embodiment thereof;

FIG. 22 is a perspective view of a fourth embodiment of our aerosol cap;

FIG. 23 is a front elevational view of the fourth embodiment thereof;

FIG. 24 is a rear elevational view of the fourth embodiment thereof;

FIG. 25 is a left side elevational view of the fourth embodiment thereof;

FIG. 26 is a right side elevational view of the fourth embodiment thereof;

FIG. 27 is a top plan view of the fourth embodiment thereof; and,

FIG. 28 is a bottom plan view of the fourth embodiment thereof.

The broken lines shown in the drawing views are included for the purpose of showing environmental structure that forms no part of the claimed design.

1 Claim, 8 Drawing Sheets

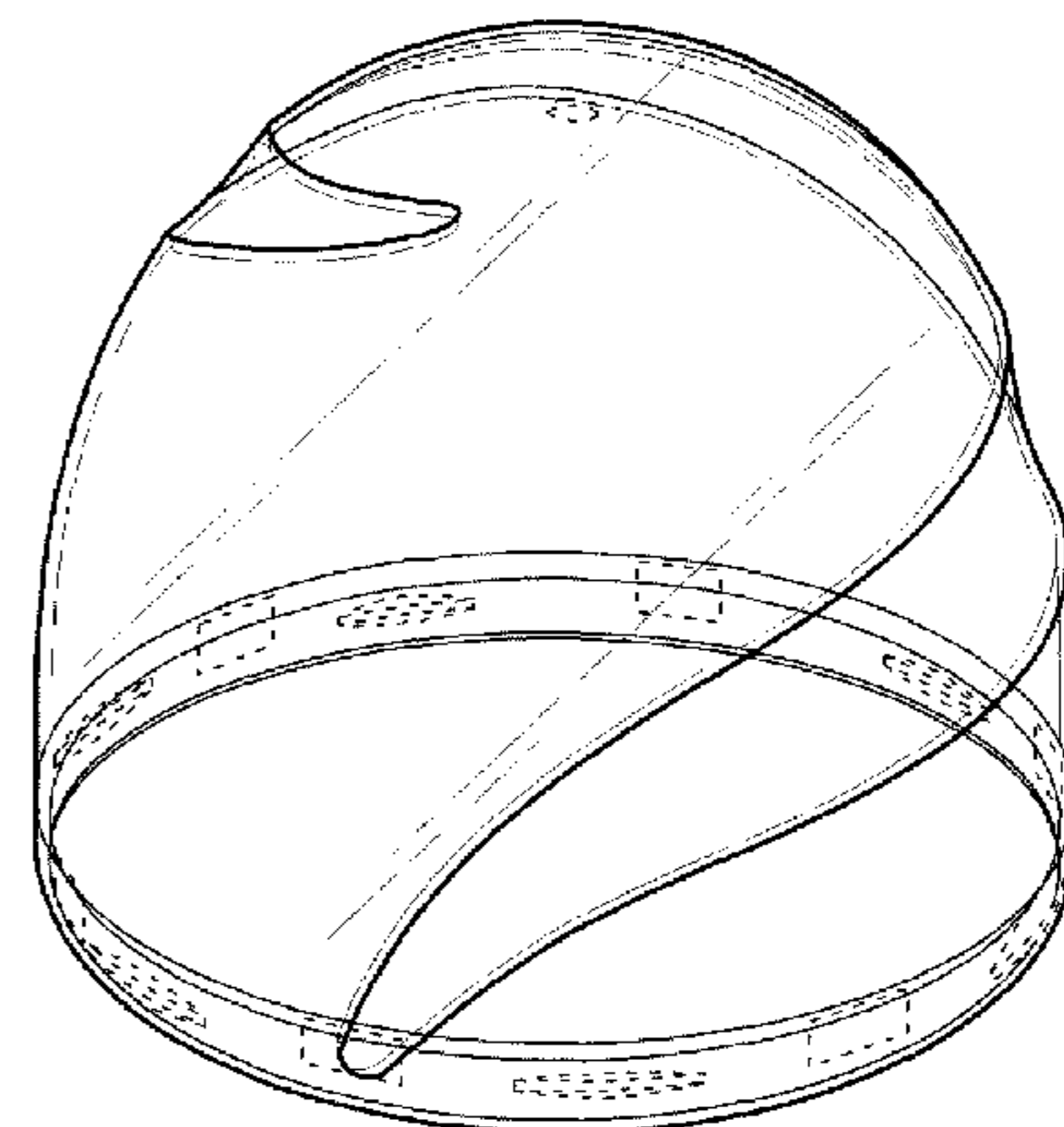
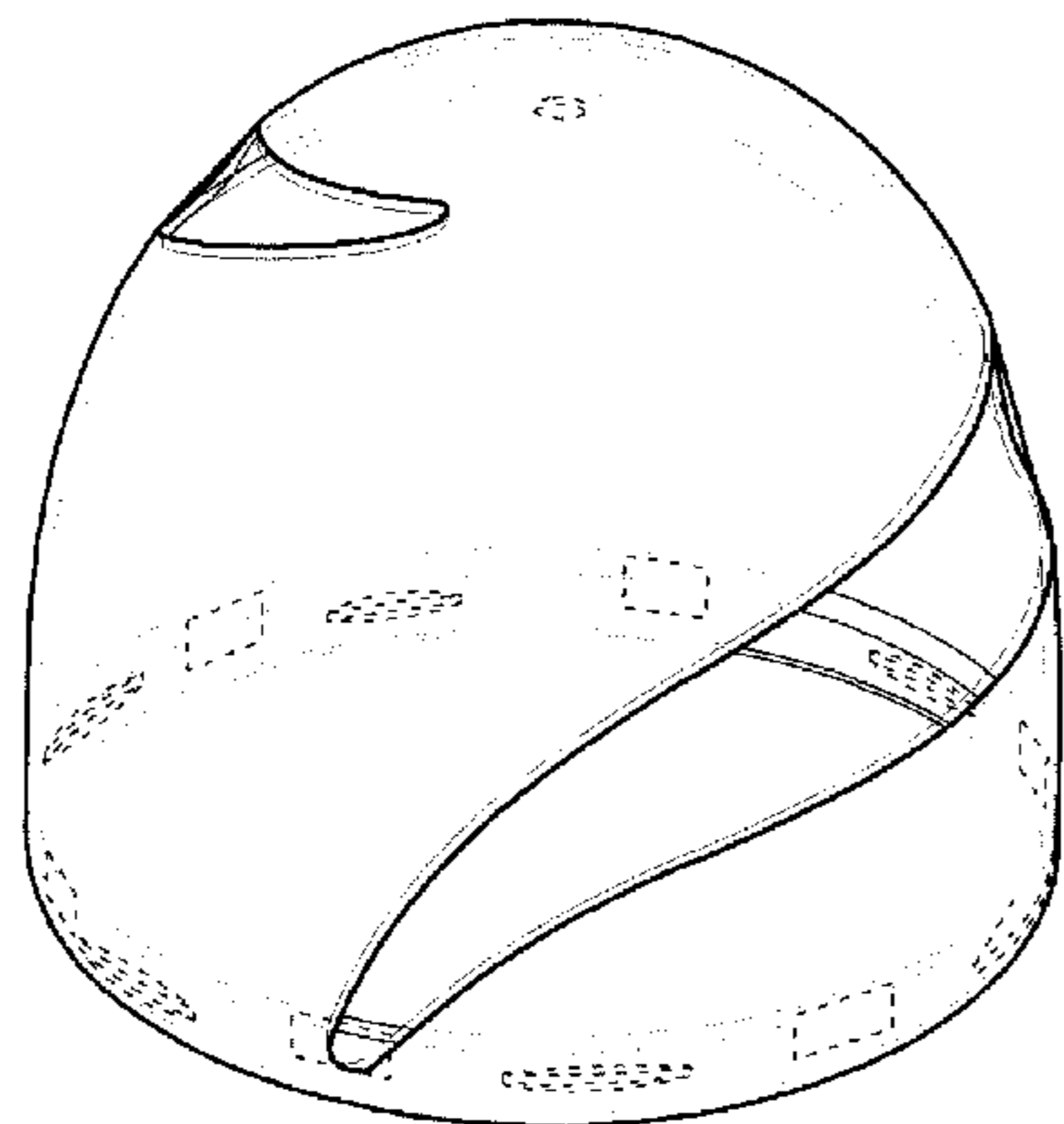

US D645,348 S

Page 2

U.S. PATENT DOCUMENTS

D484,585 S	*	12/2003	Upson	D23/366	D583,455 S	*	12/2008	Kay et al.	D23/366
D509,890 S	*	9/2005	Stavale et al.	D23/366	D583,457 S	*	12/2008	Kay et al.	D23/366
D582,537 S	*	12/2008	Kay et al.	D23/366	D583,921 S	*	12/2008	Kay et al.	D23/366
D583,038 S	*	12/2008	Kay et al.	D23/366	D616,740 S	*	6/2010	Akers et al.	D9/432
D583,039 S	*	12/2008	Kay et al.	D23/366	D627,224 S	*	11/2010	Bass et al.	D9/445
D583,453 S	*	12/2008	Kay et al.	D23/366					
D583,454 S	*	12/2008	Kay et al.	D23/366					

* cited by examiner

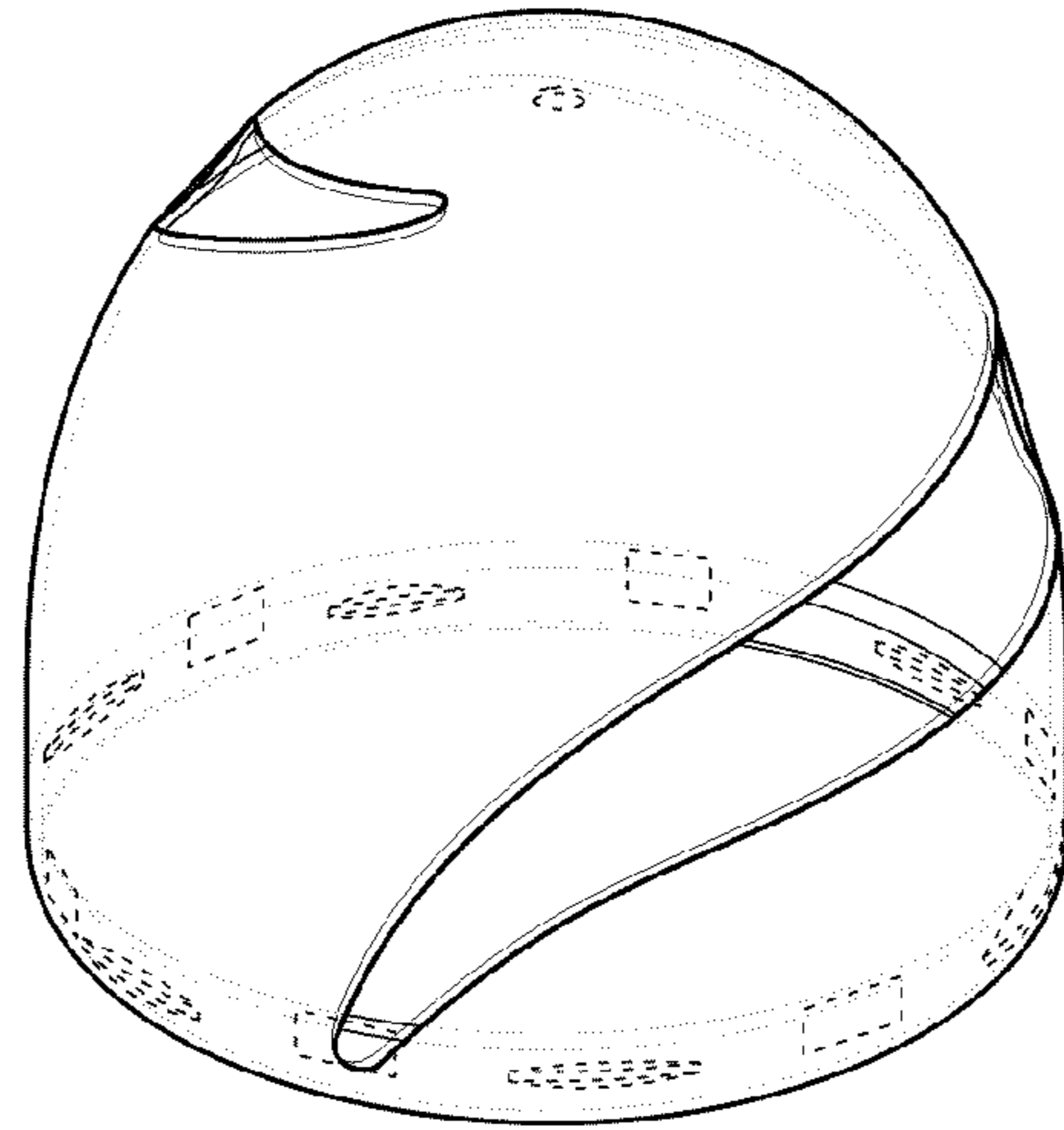

Fig.1

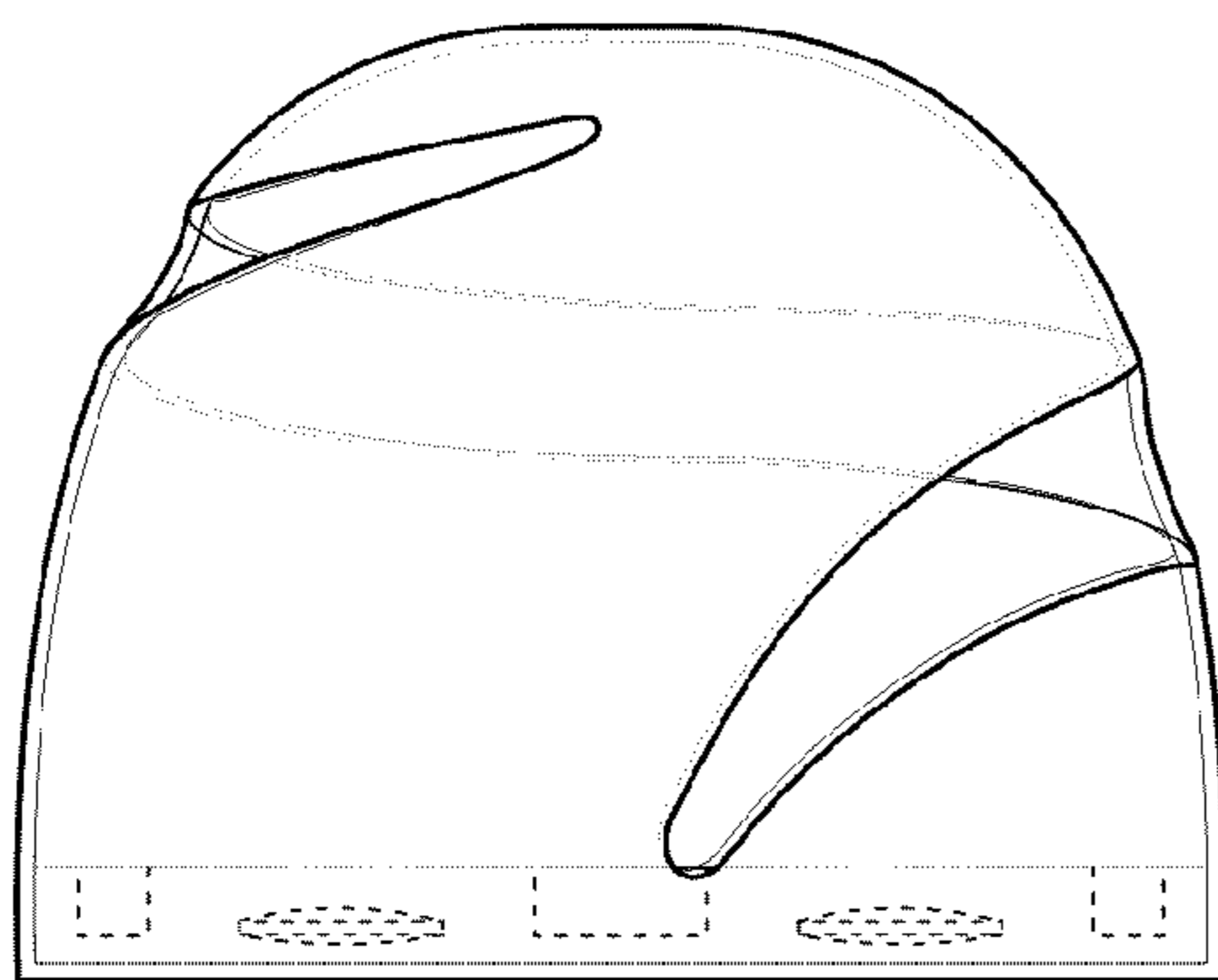

Fig.2

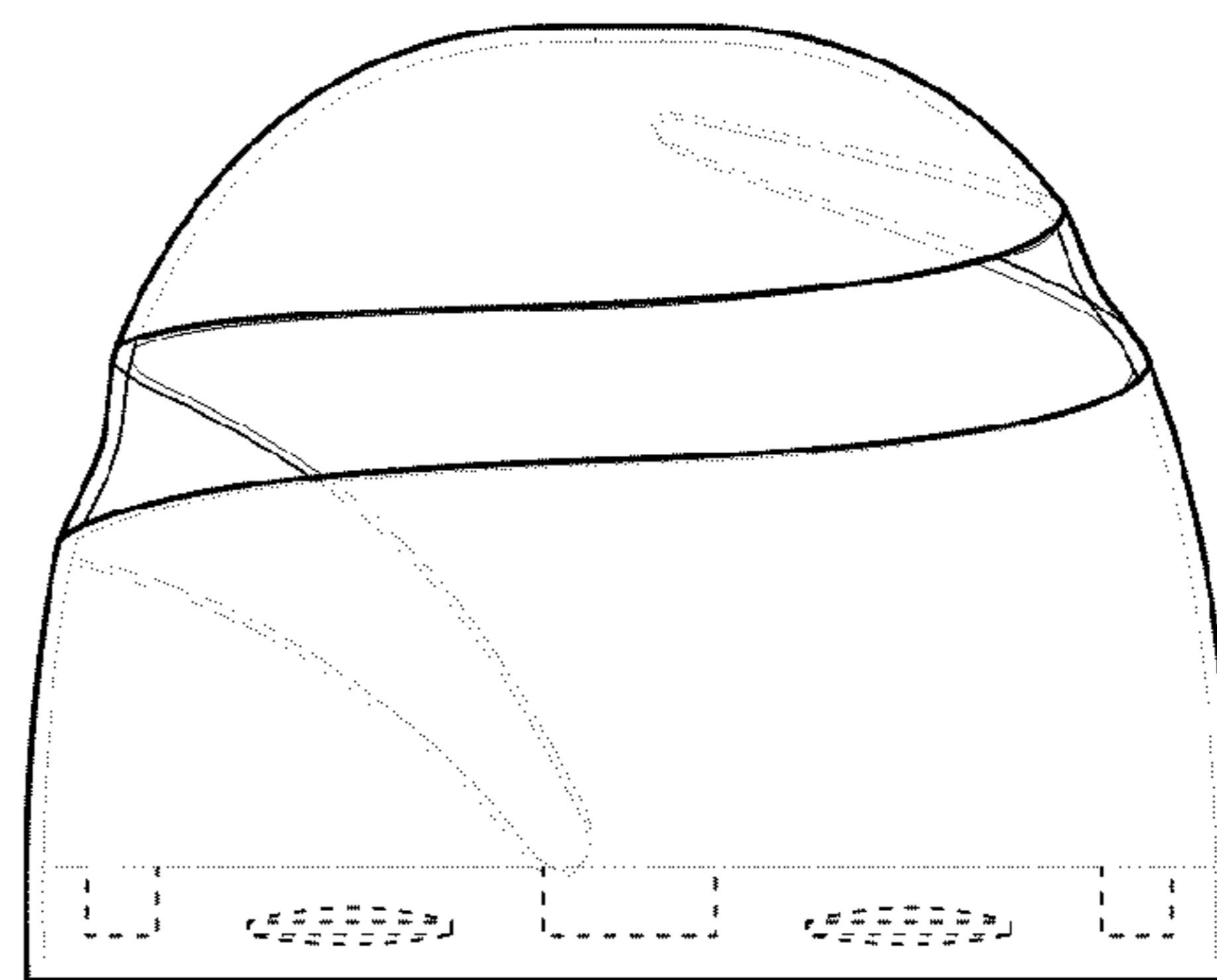

Fig.3

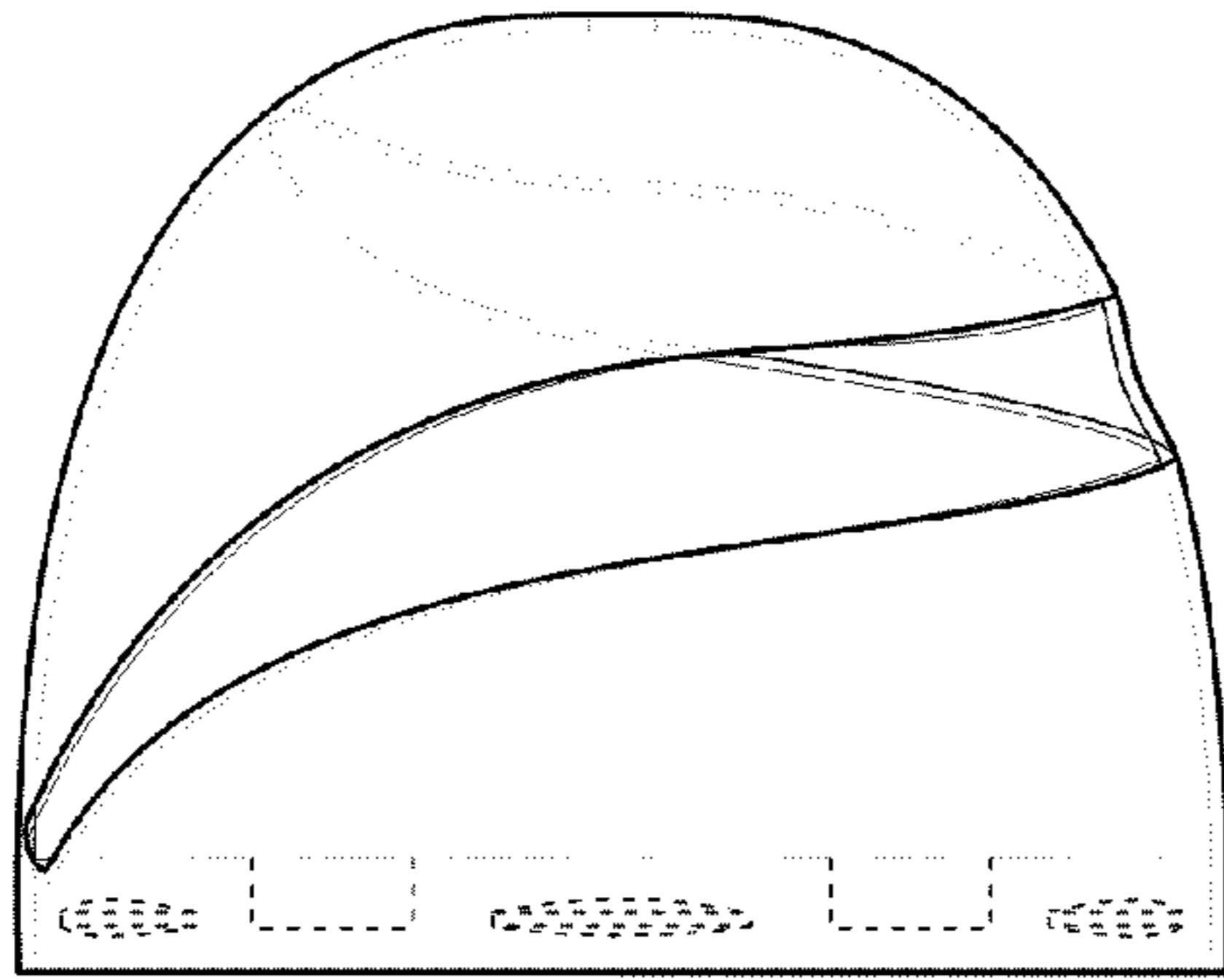

Fig.4

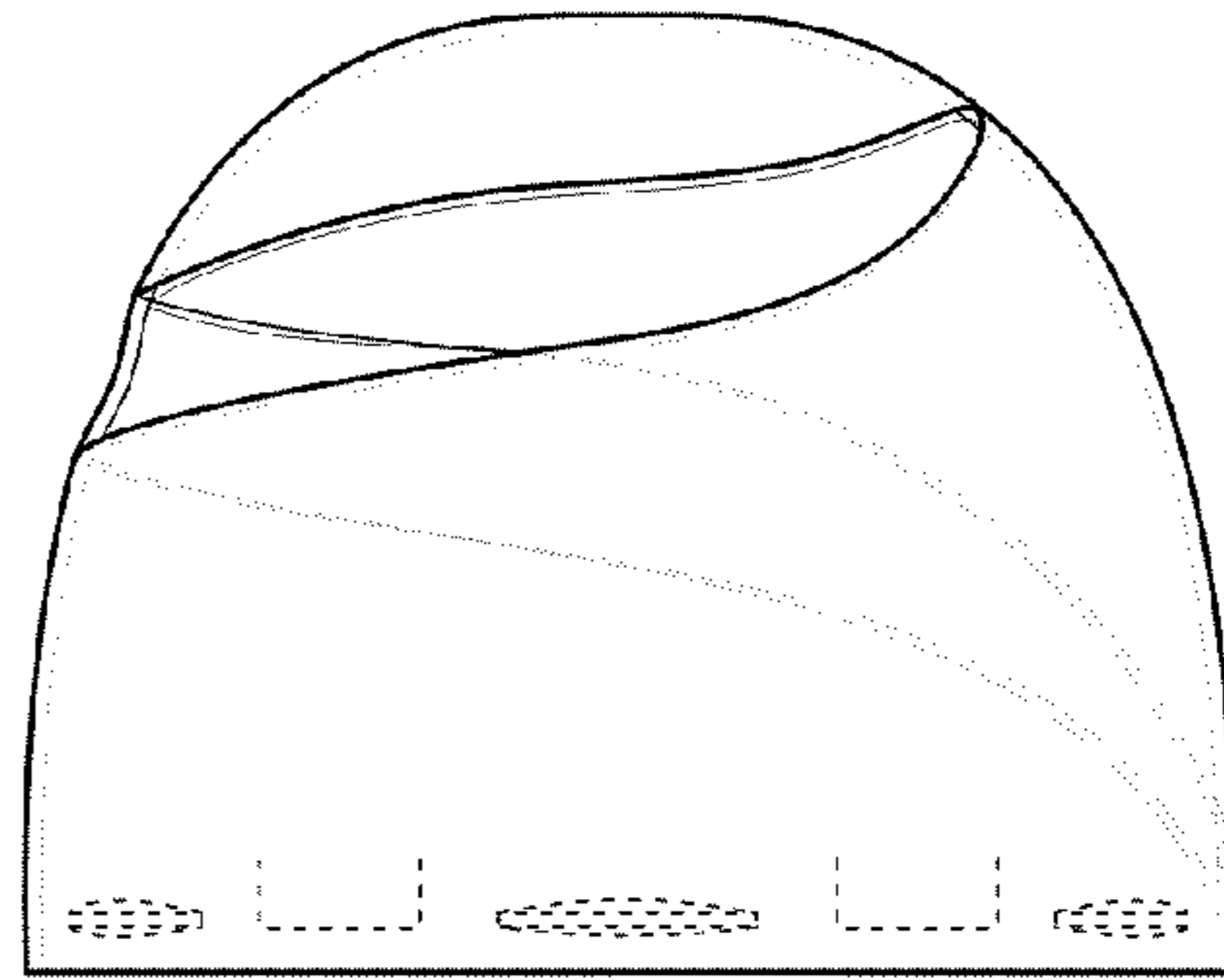

Fig.5

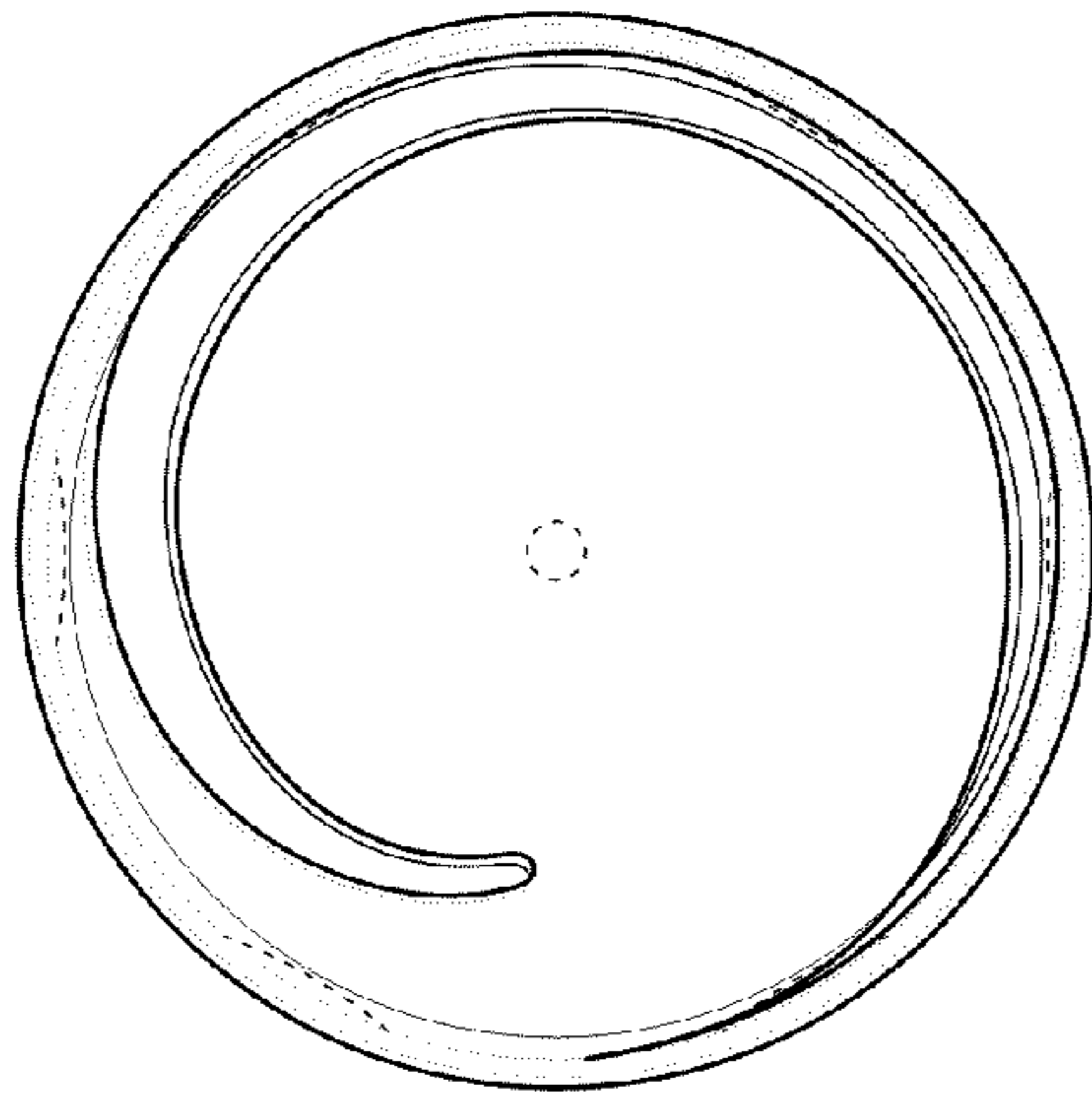

Fig.6

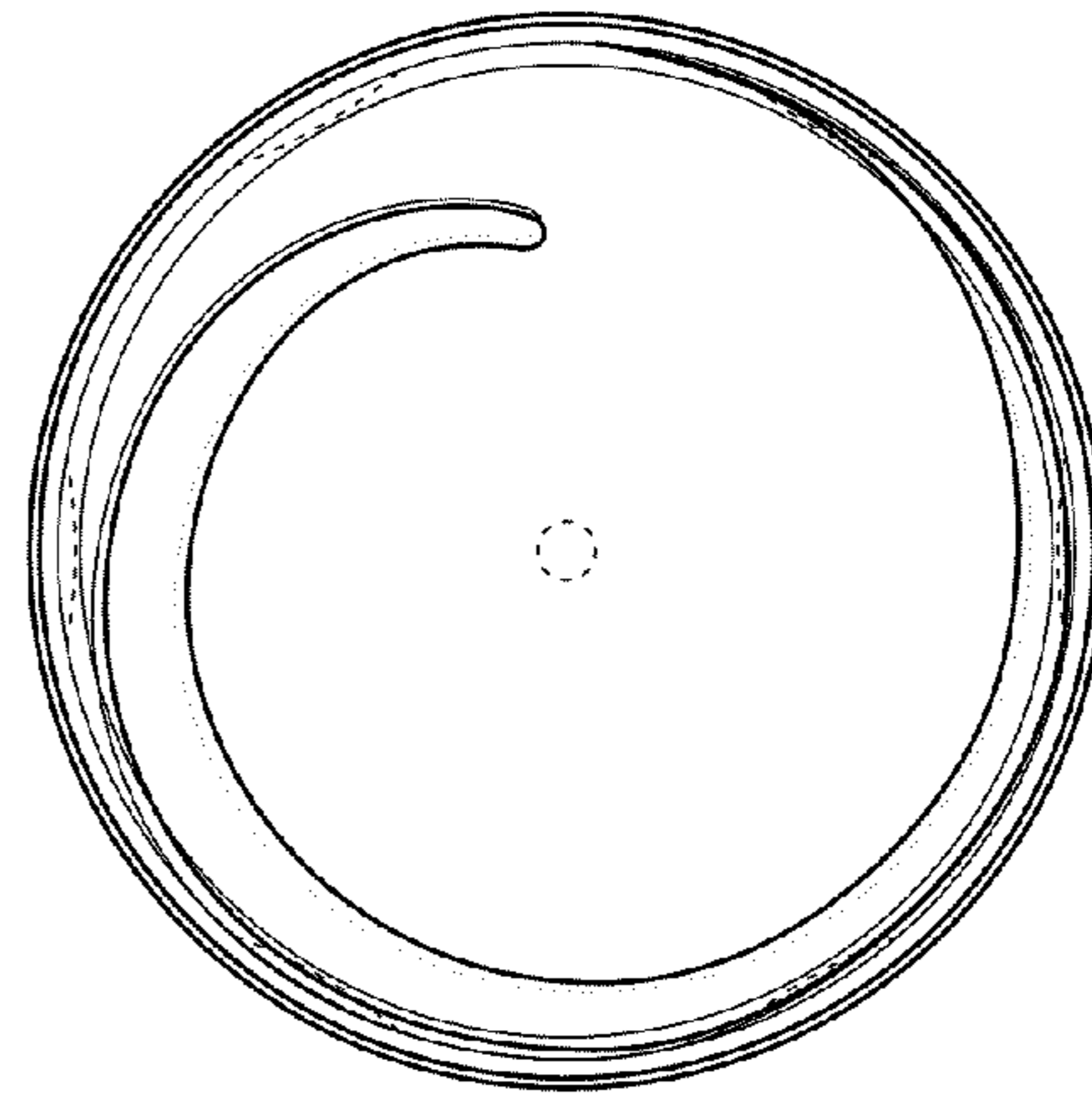

Fig.7

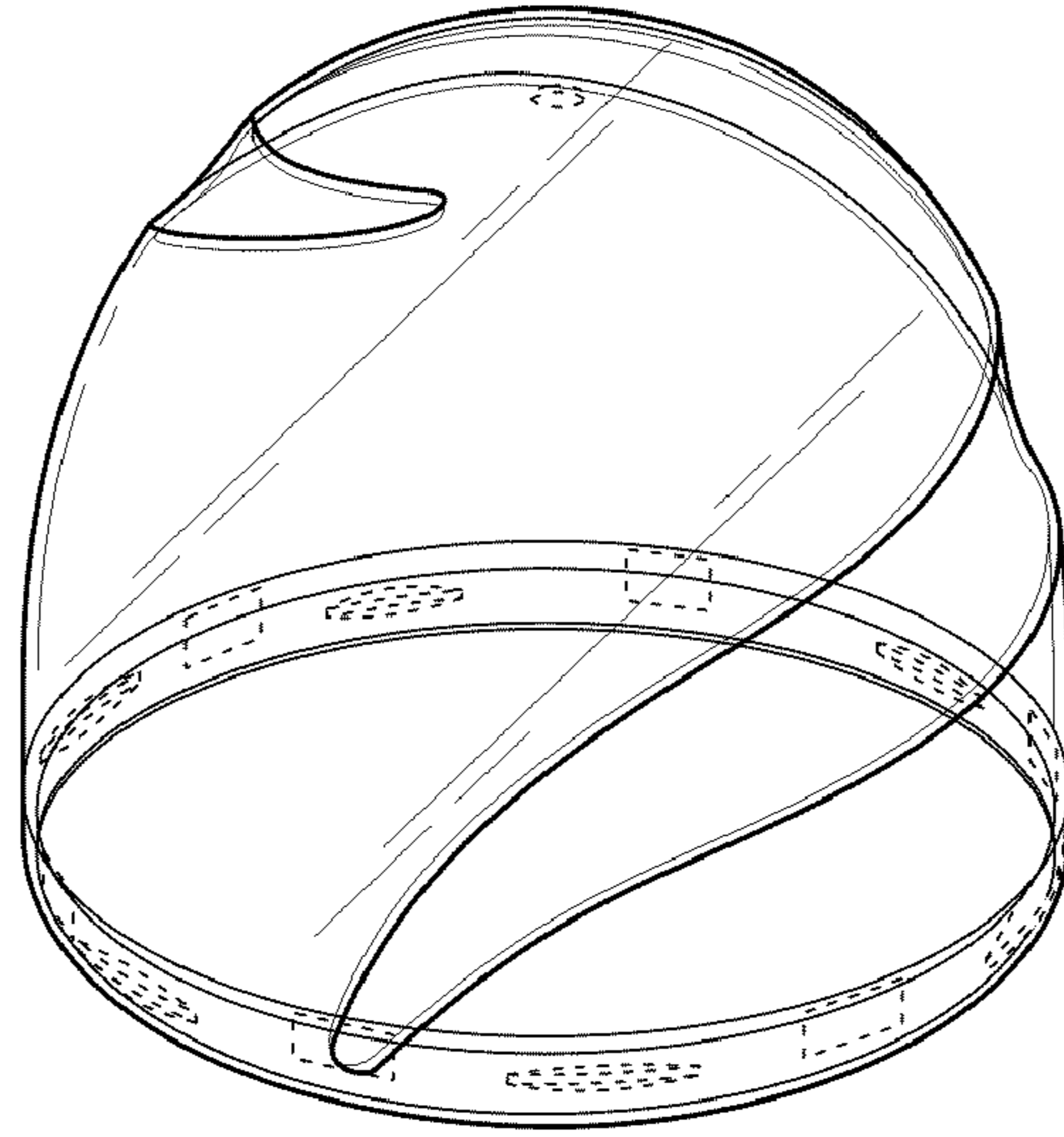

Fig. 8

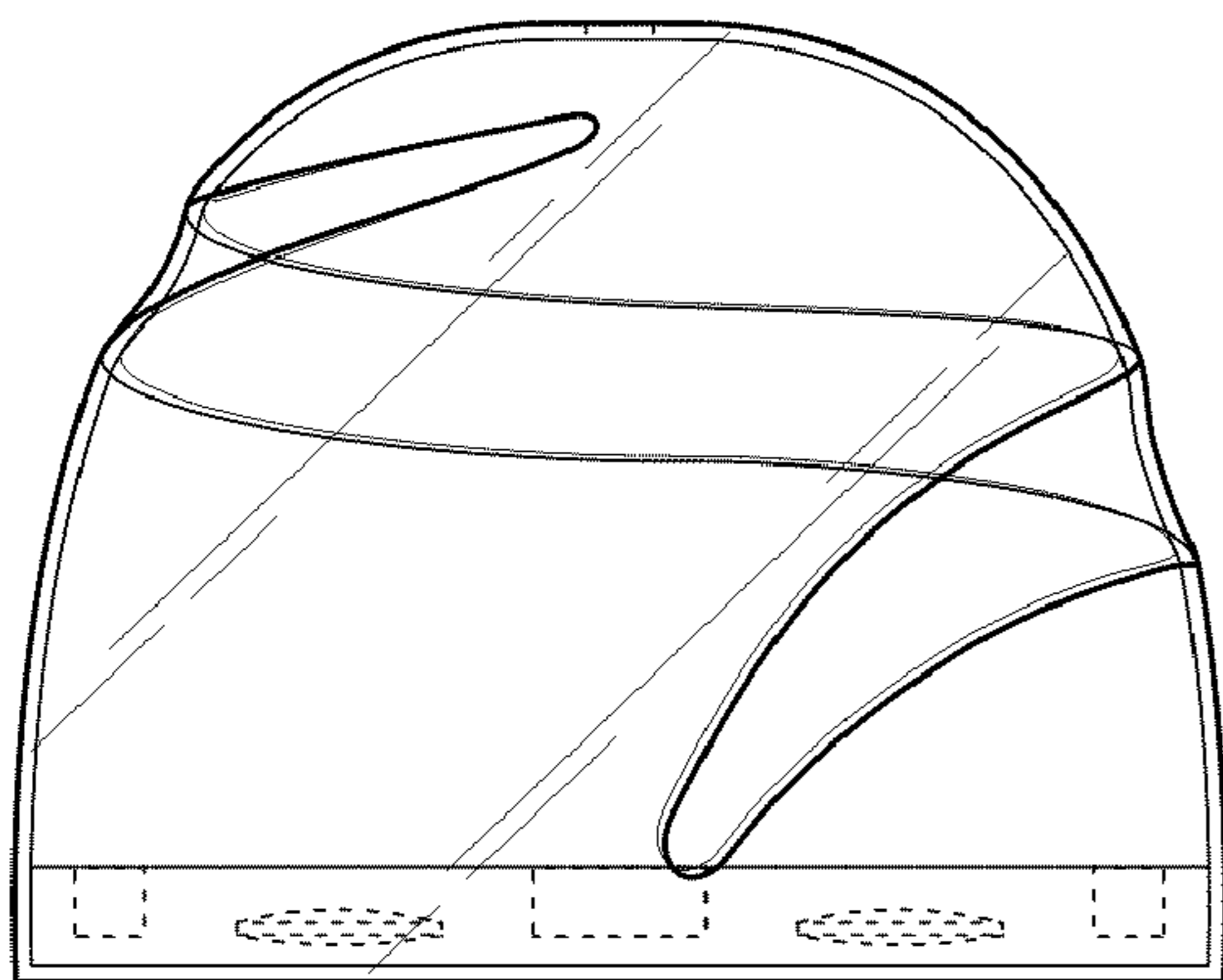

Fig. 9

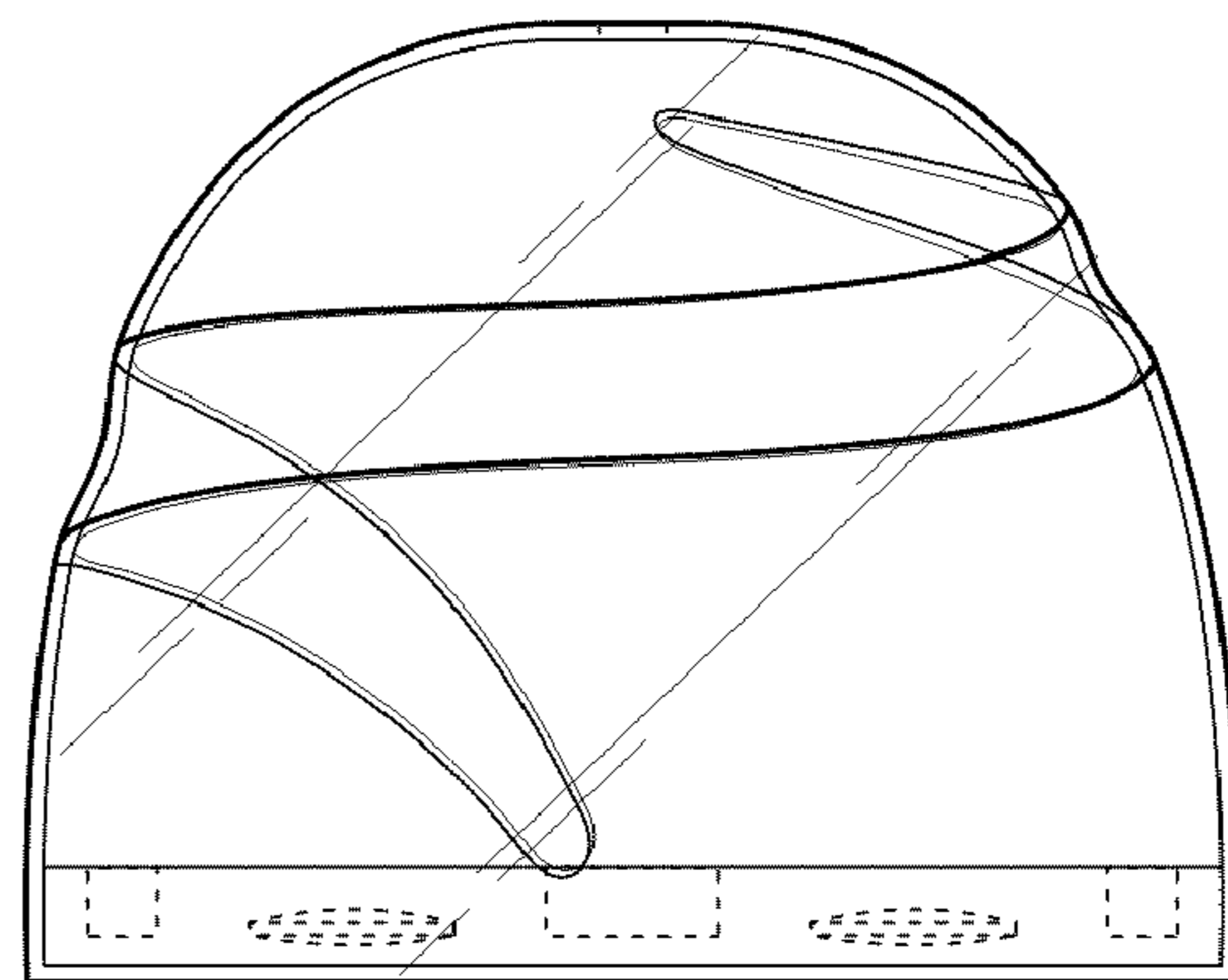

Fig. 10

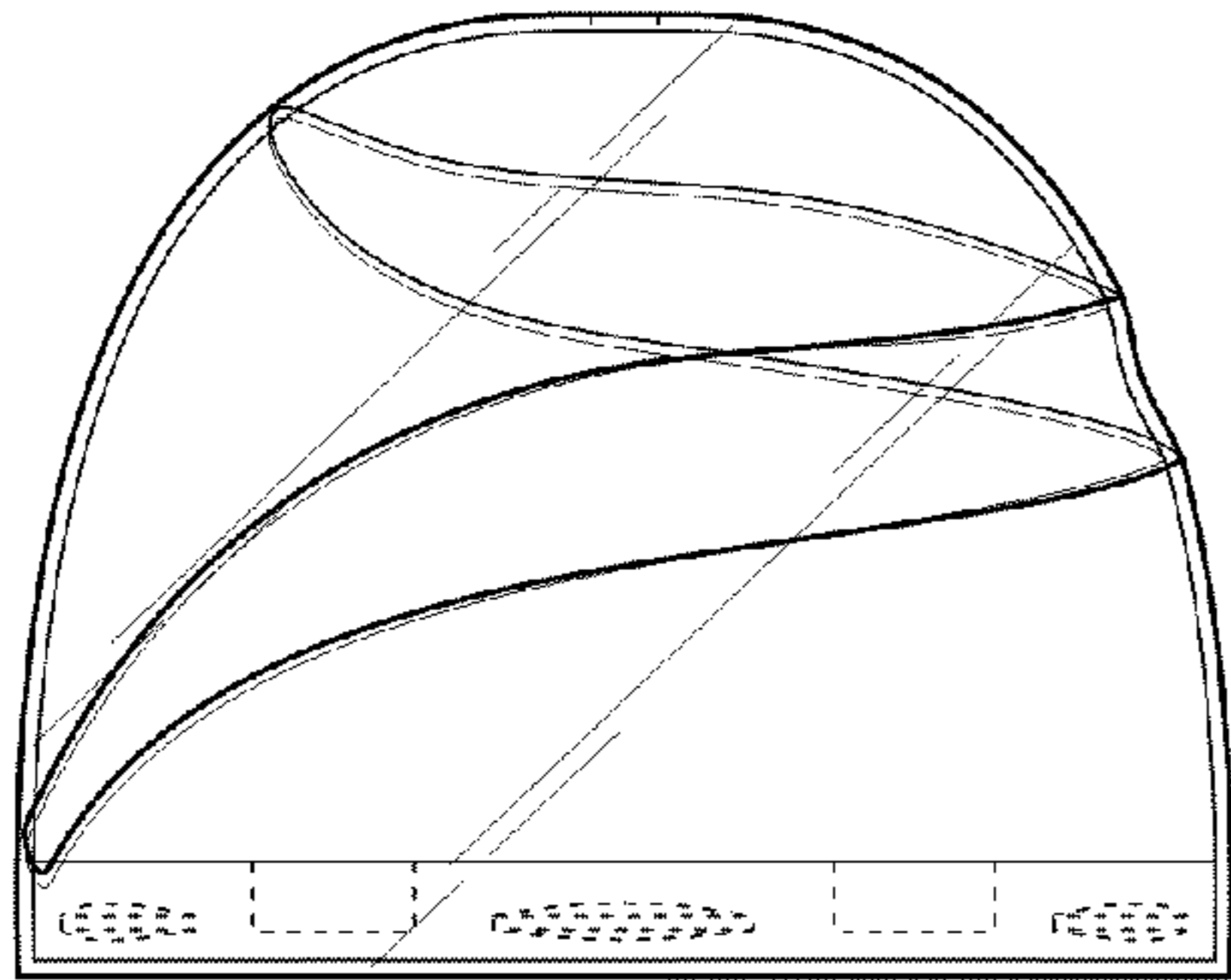

Fig. 11

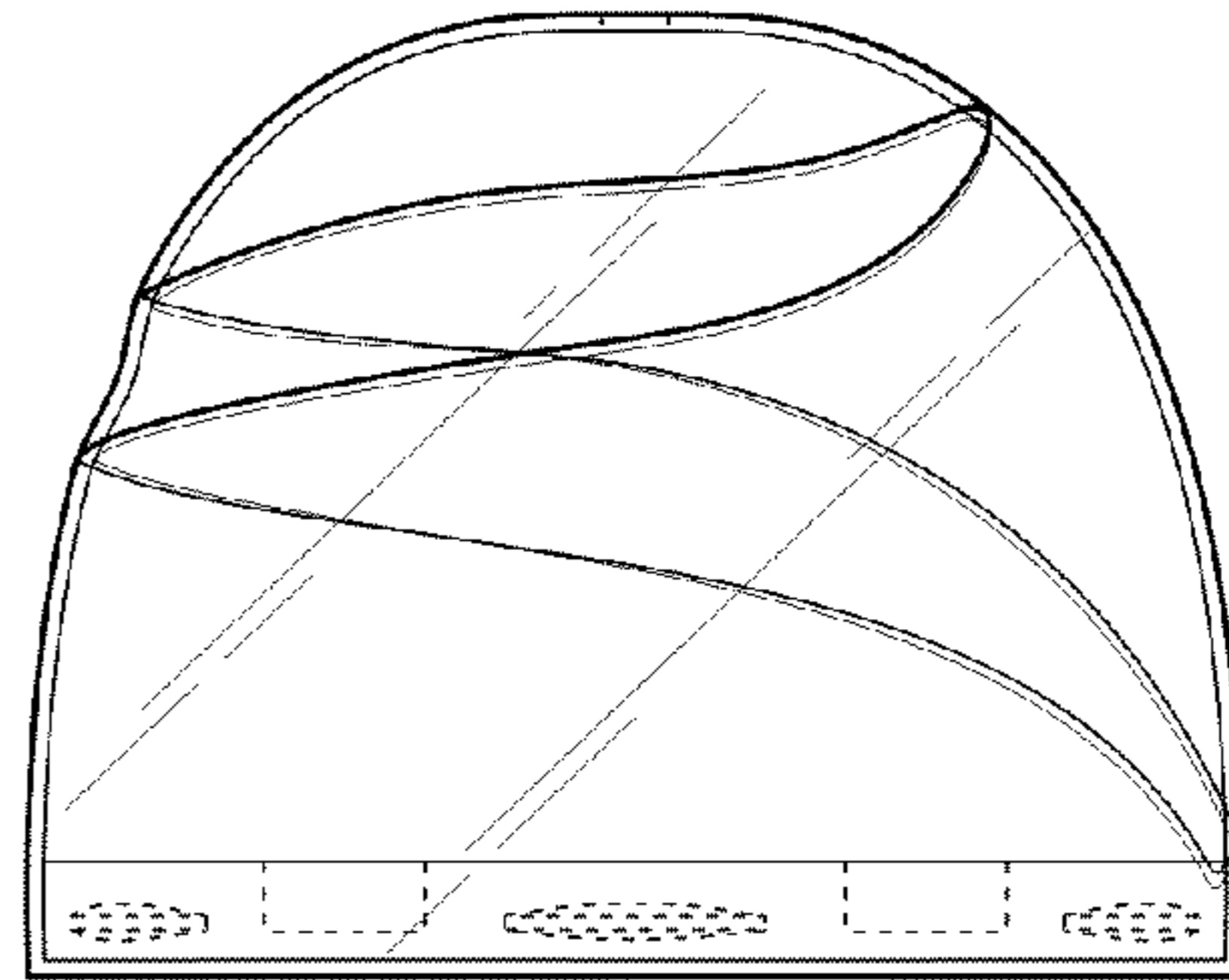

Fig. 12

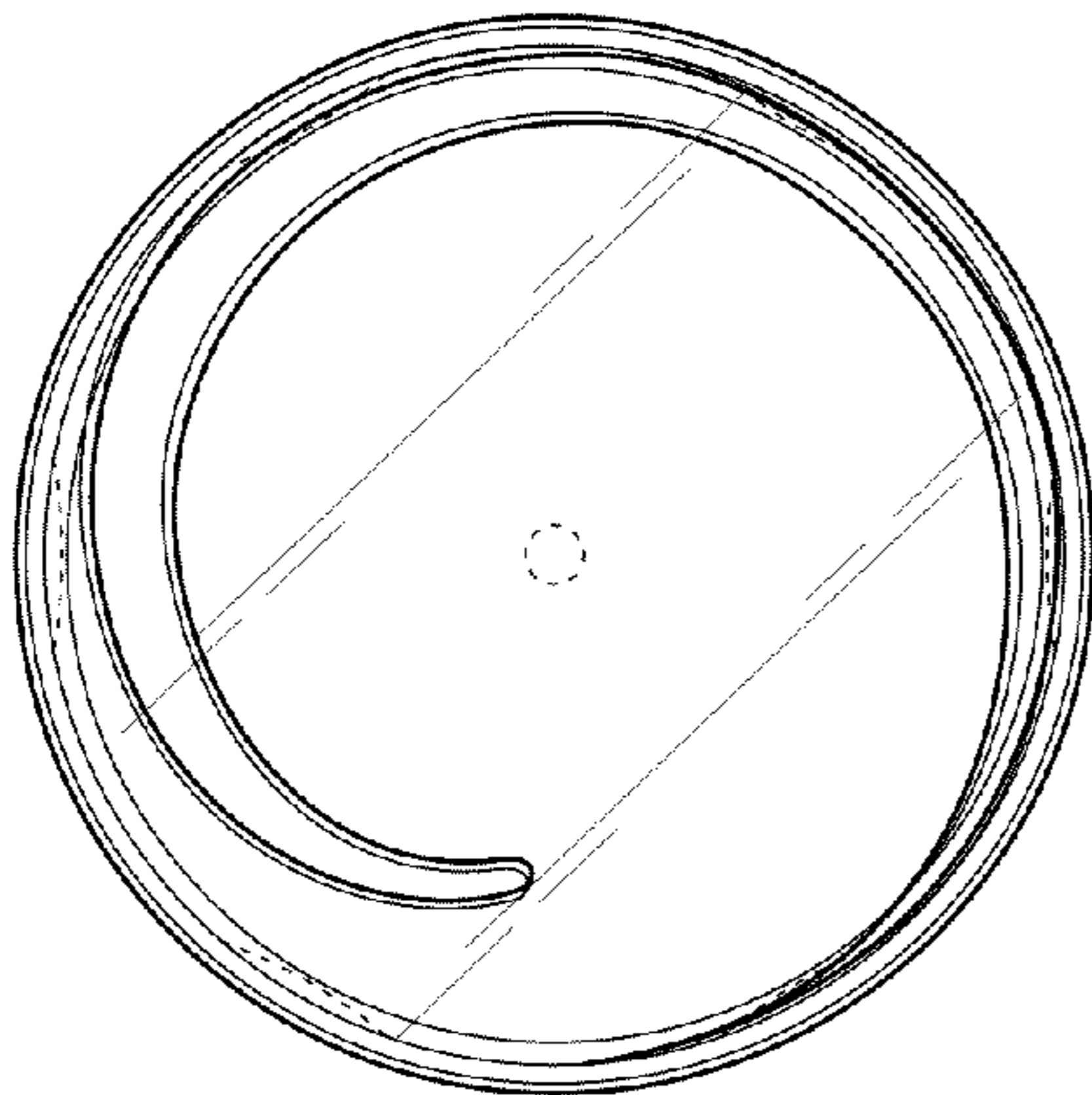

Fig. 13

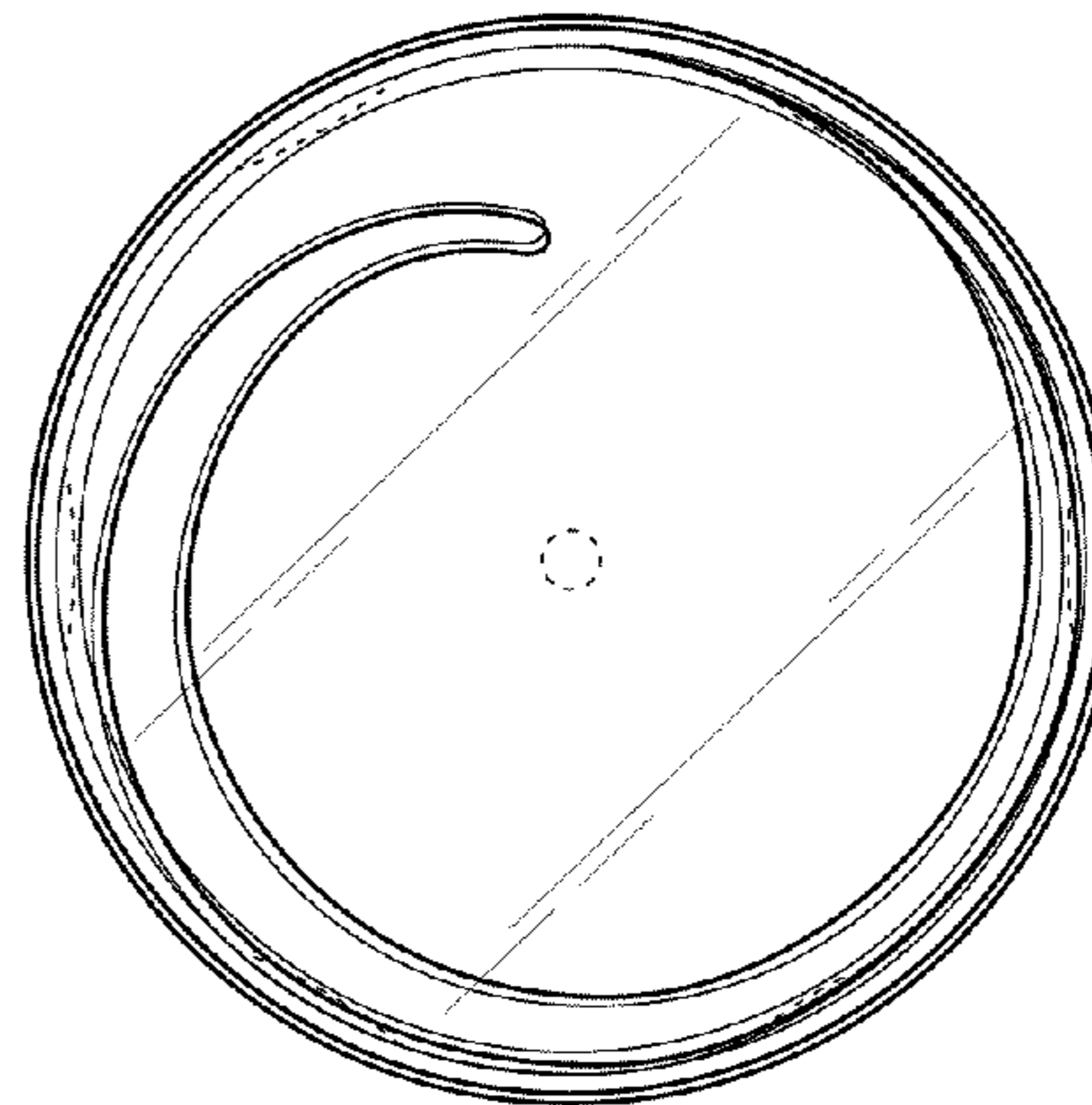

Fig. 14

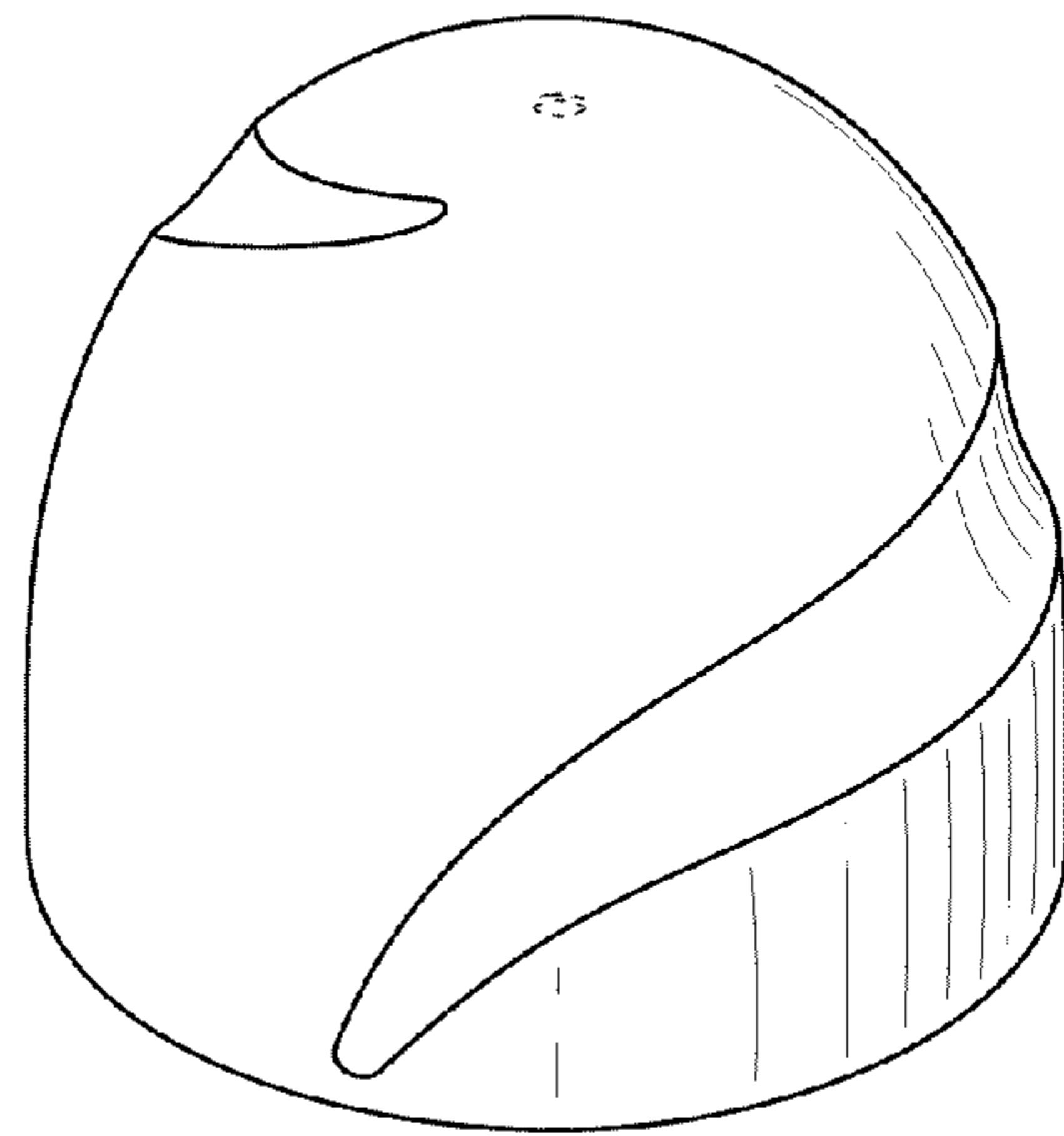

Fig. 15

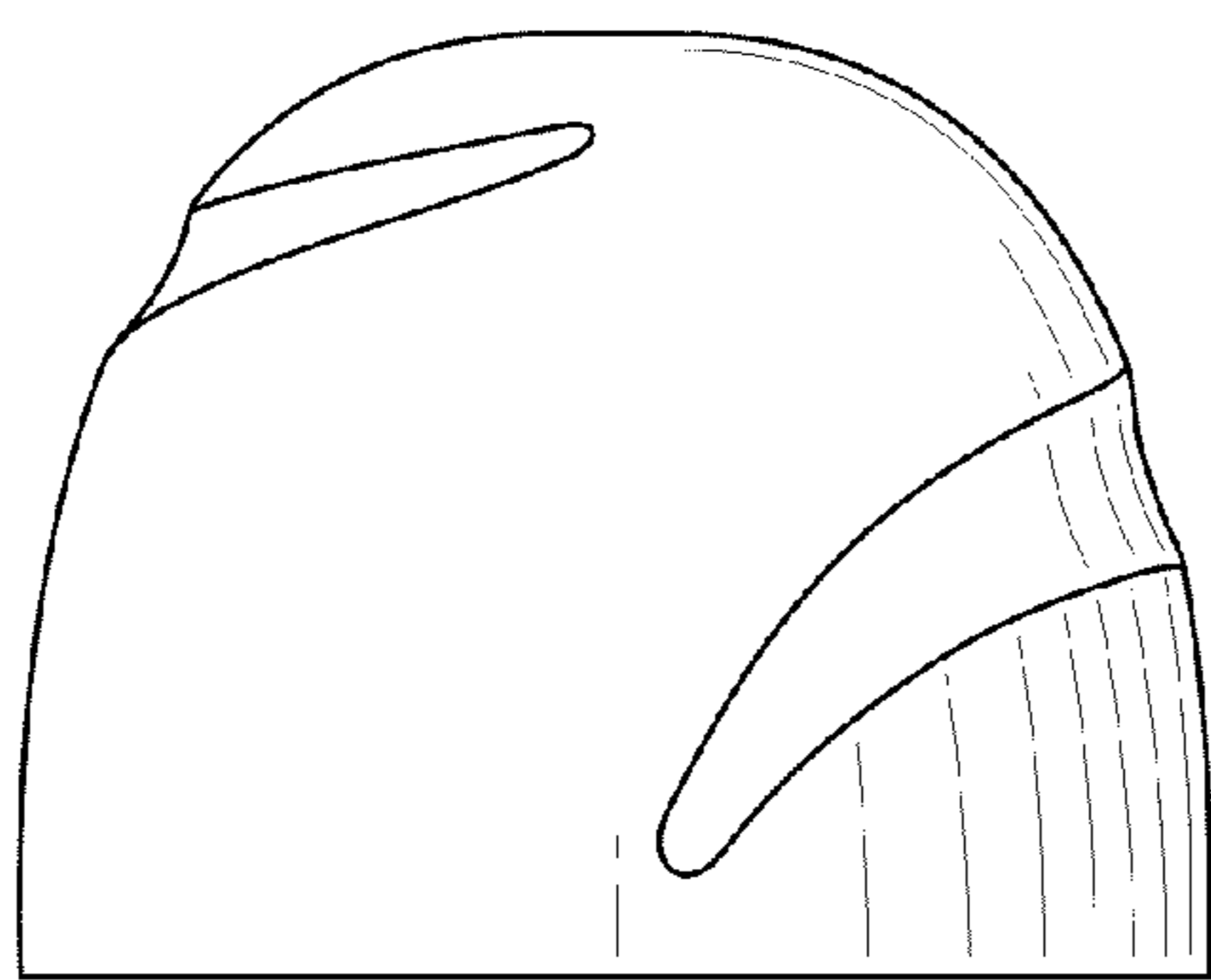

Fig. 16

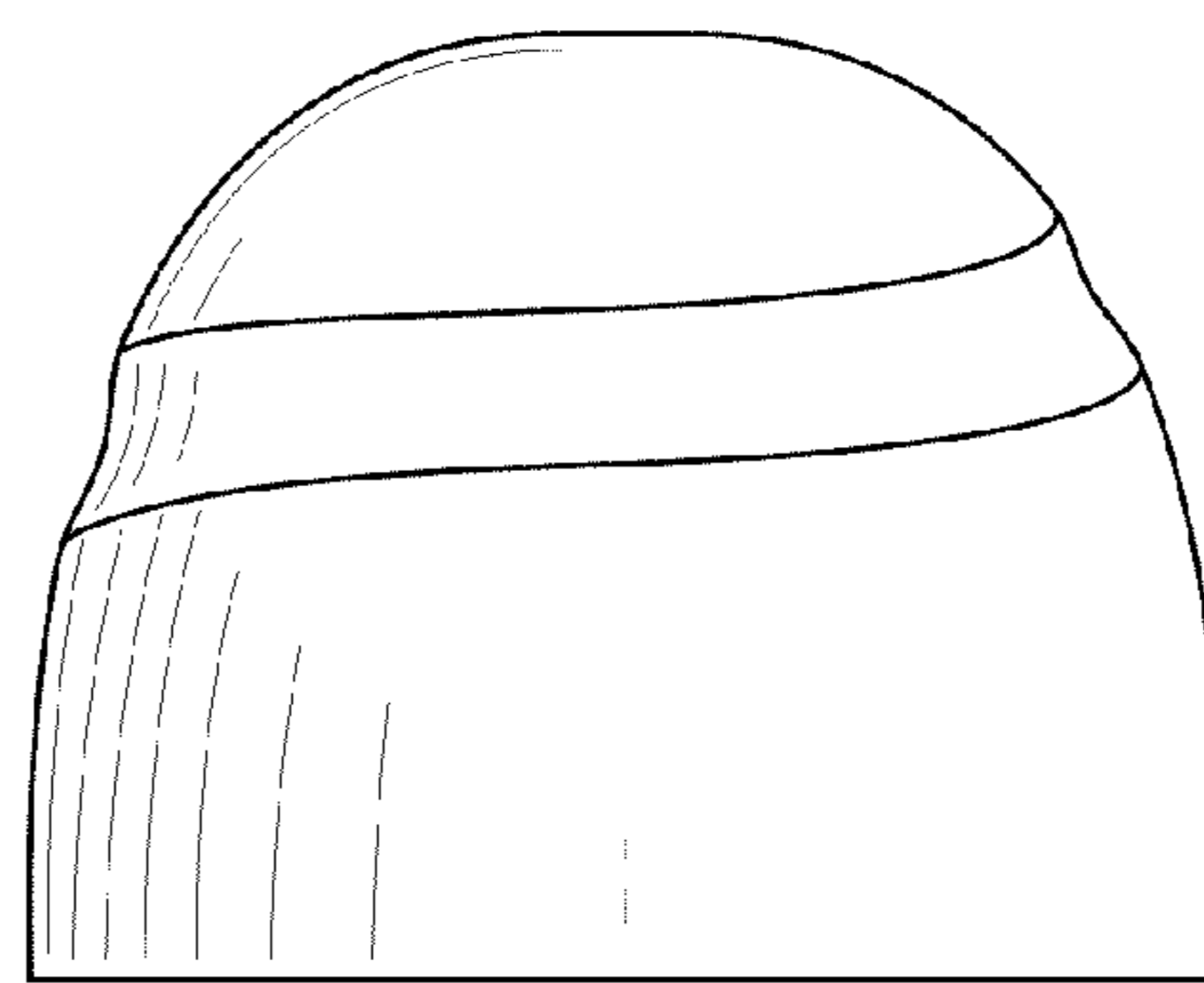

Fig. 17

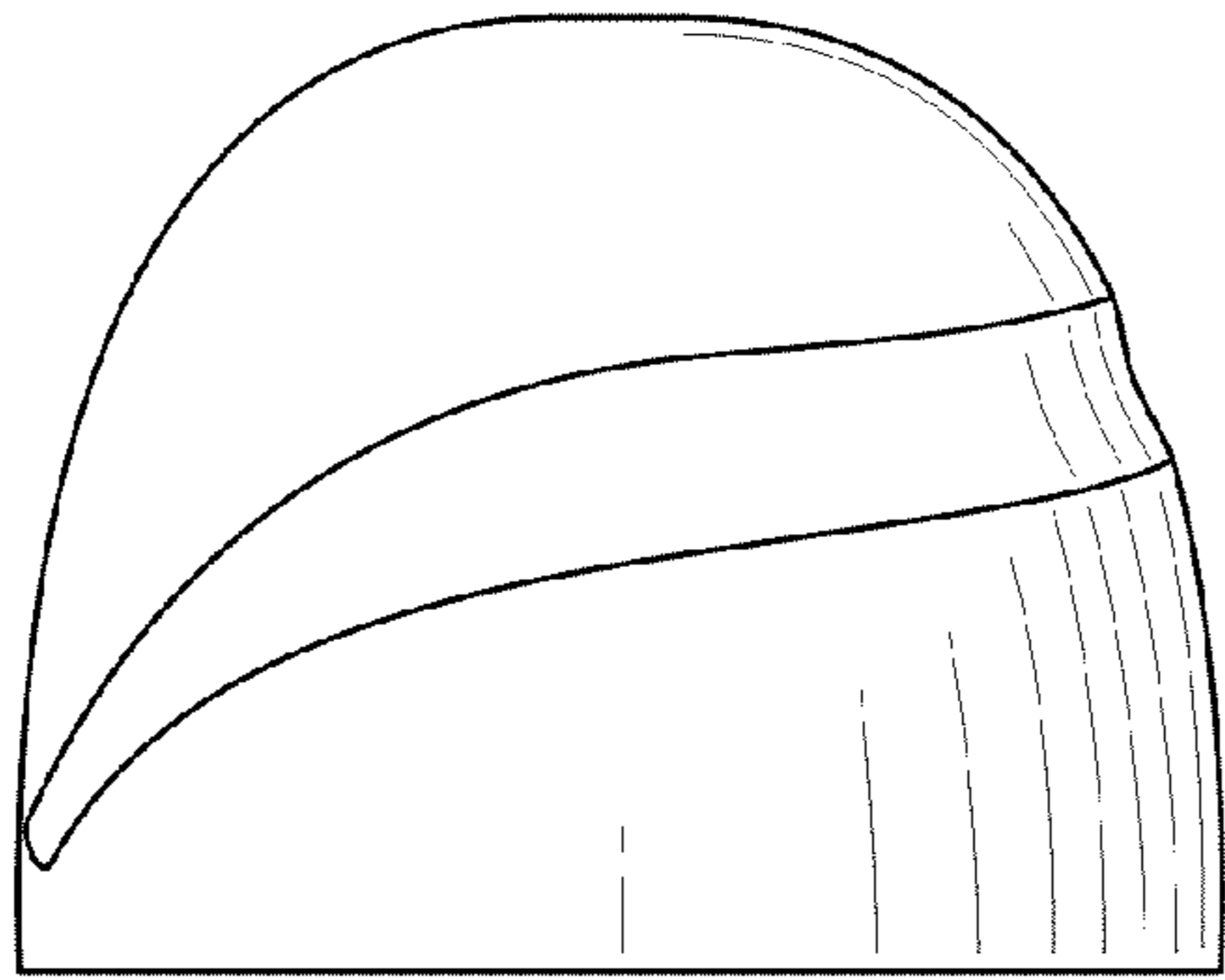

Fig. 18

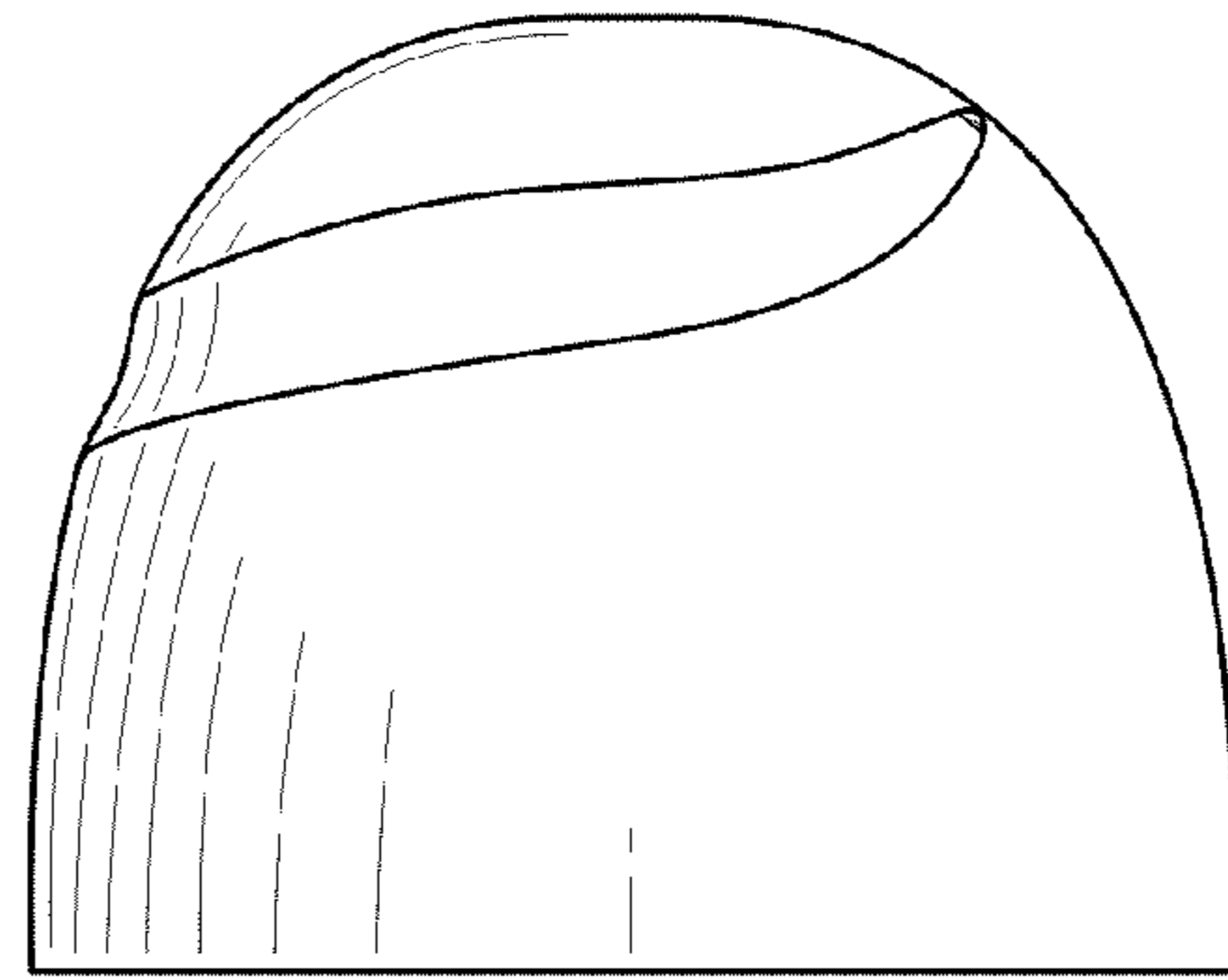

Fig. 19

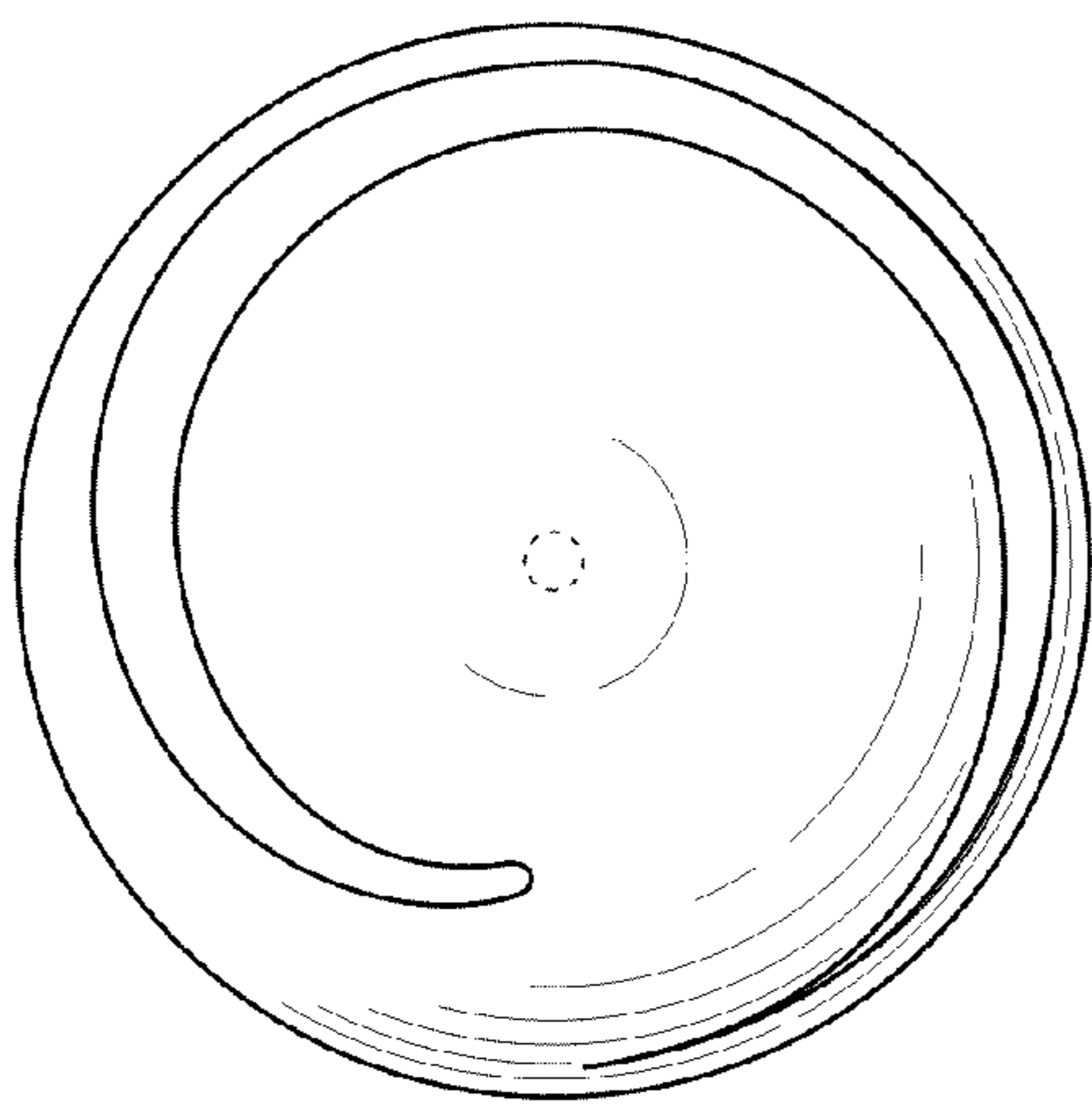

Fig. 20

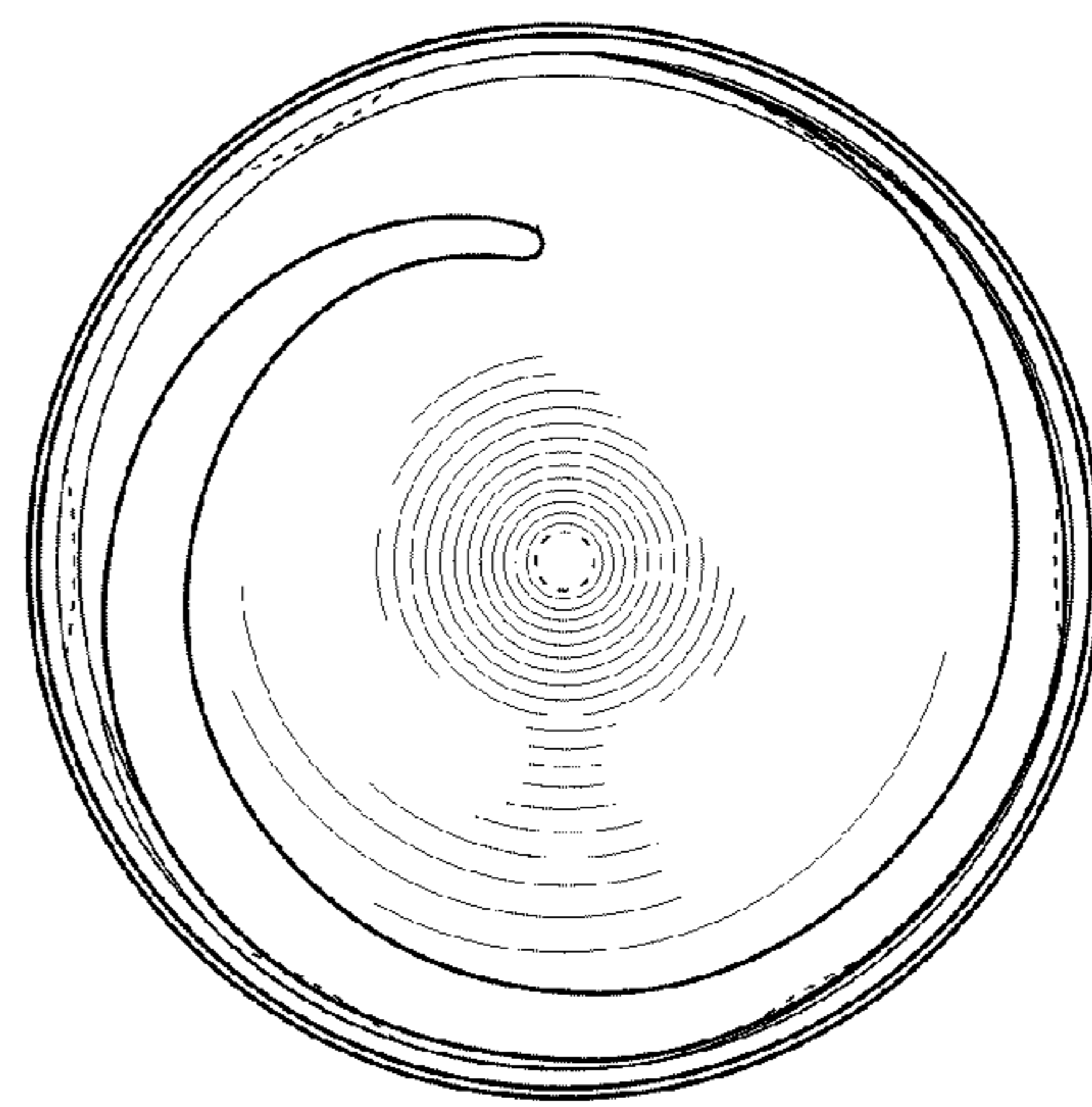

Fig. 21

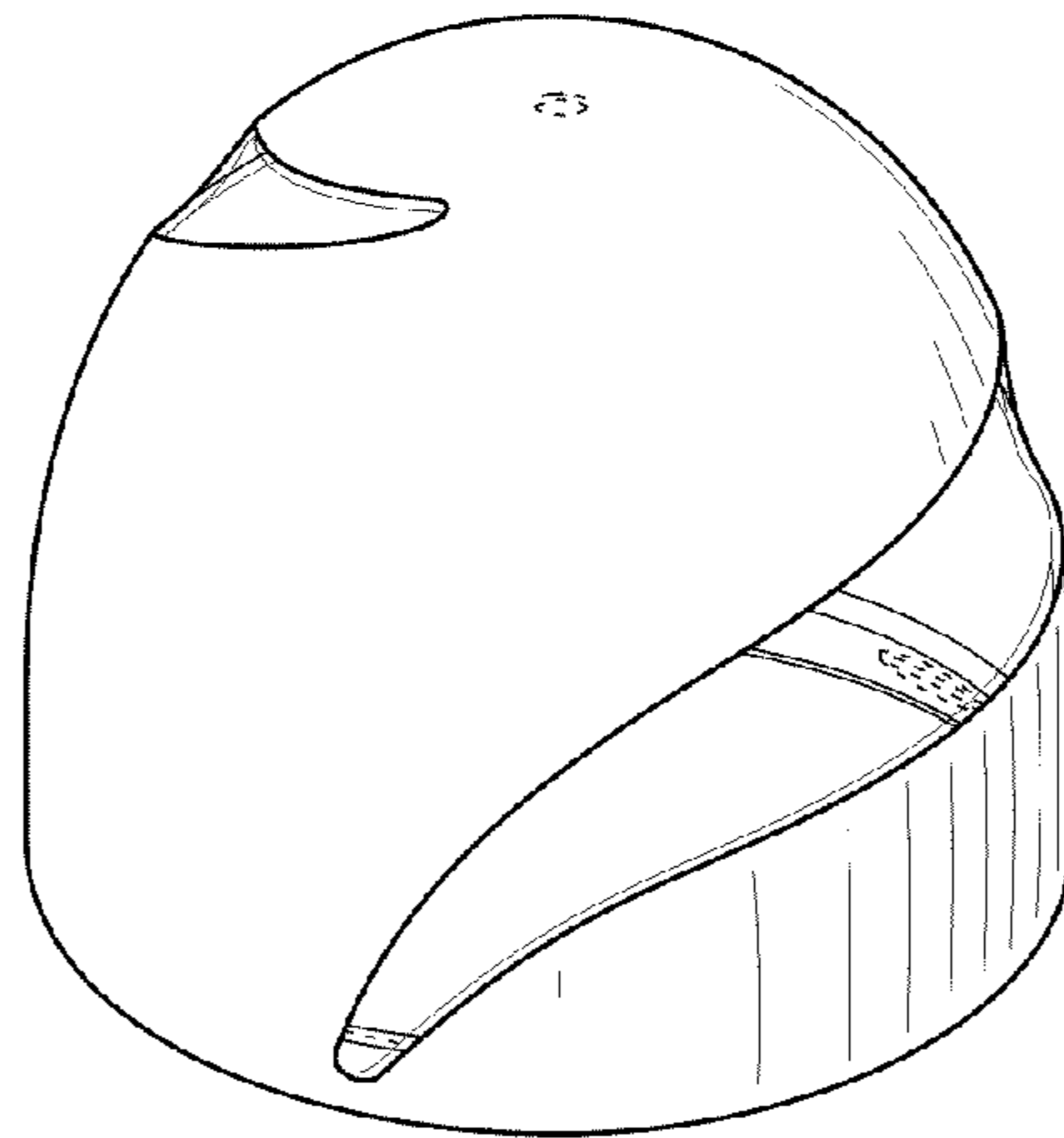

Fig. 22

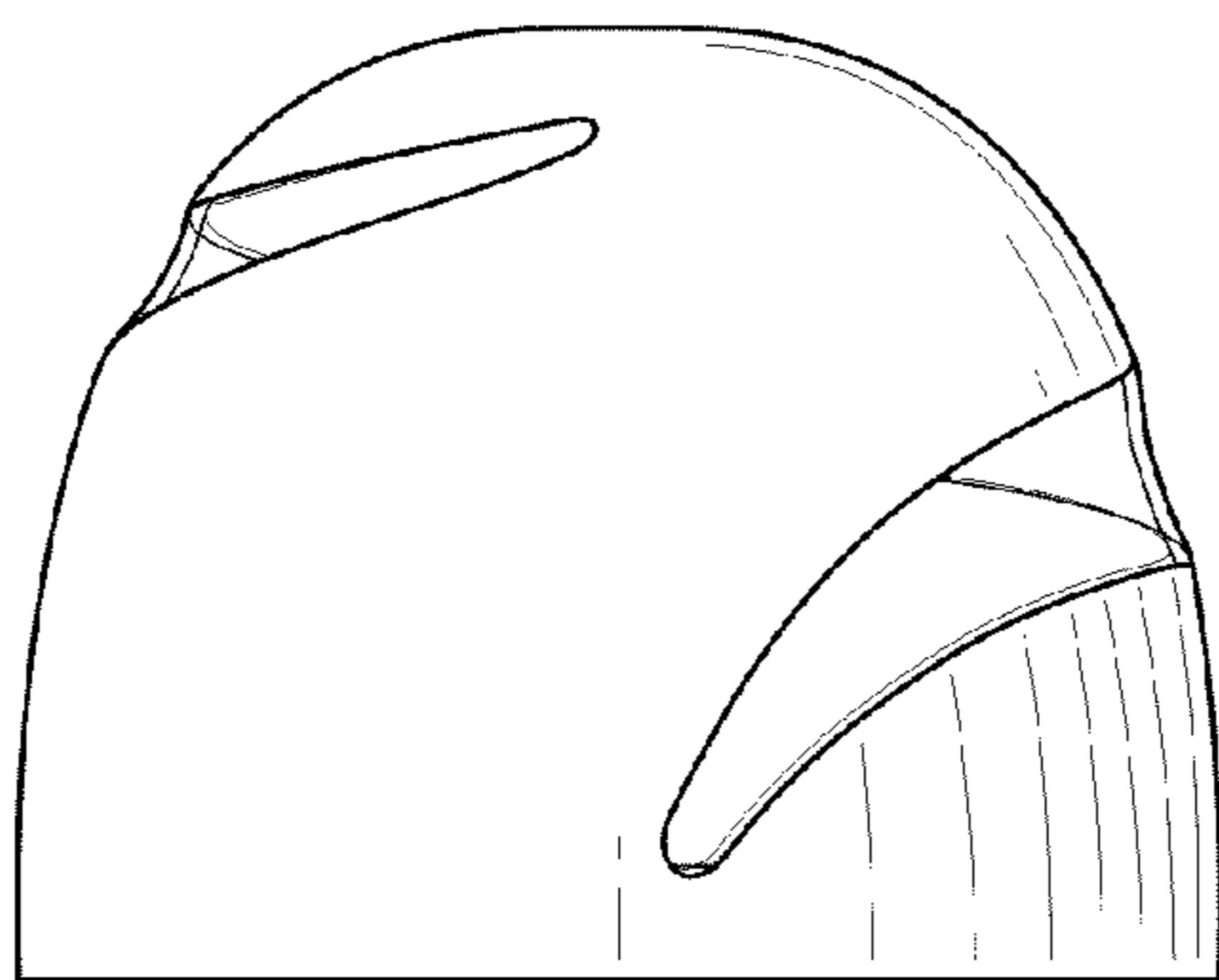

Fig. 23

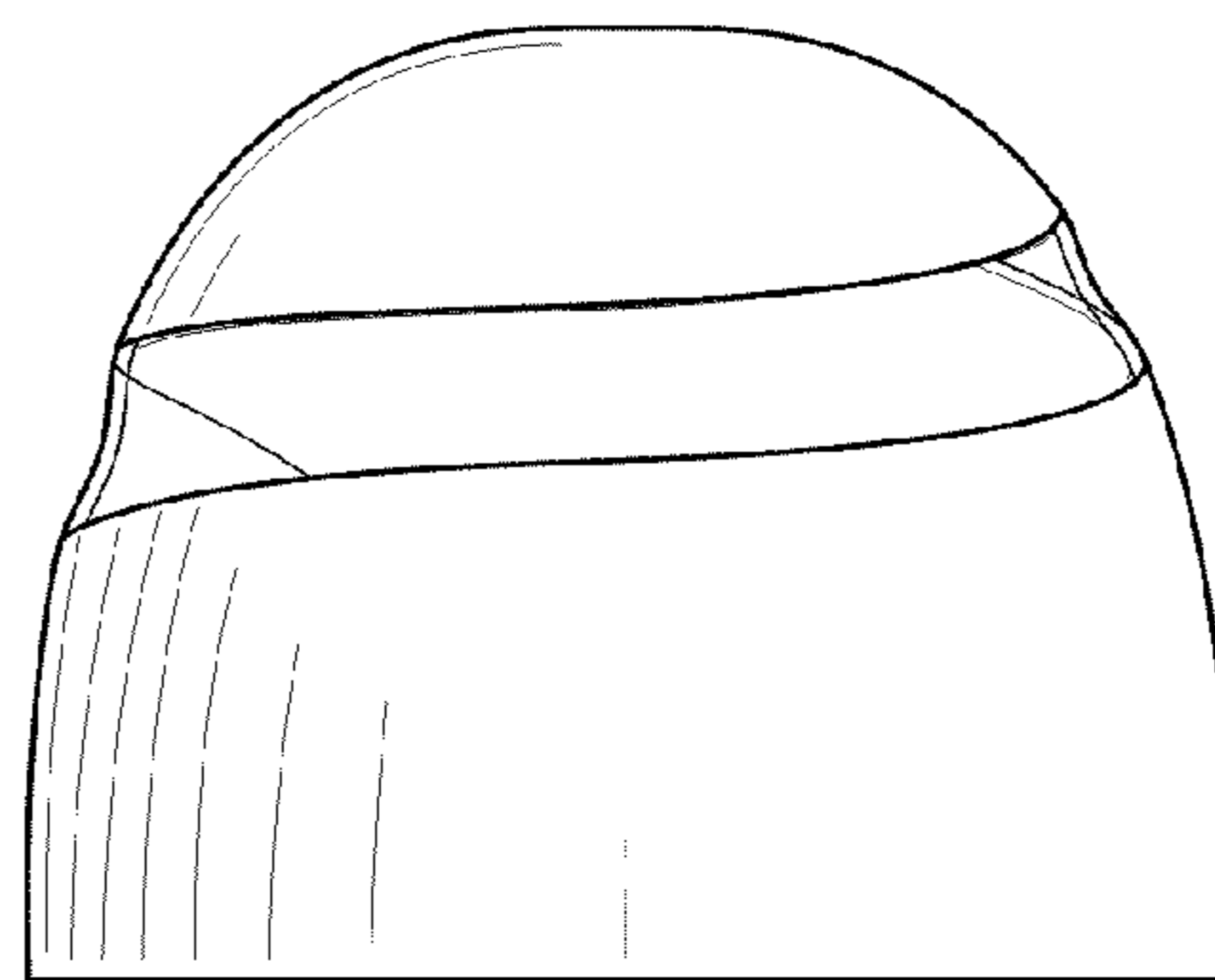

Fig. 24

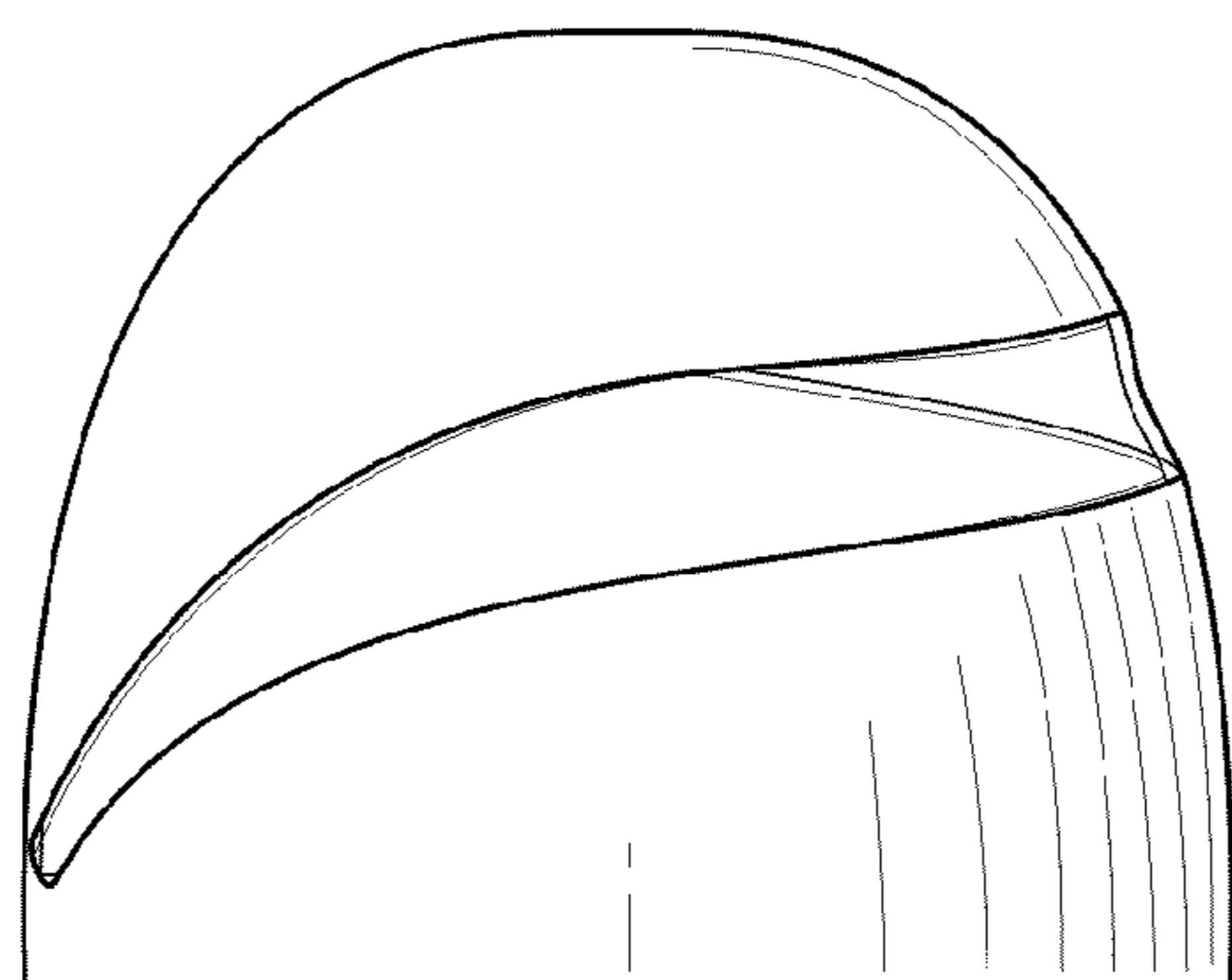

Fig. 25

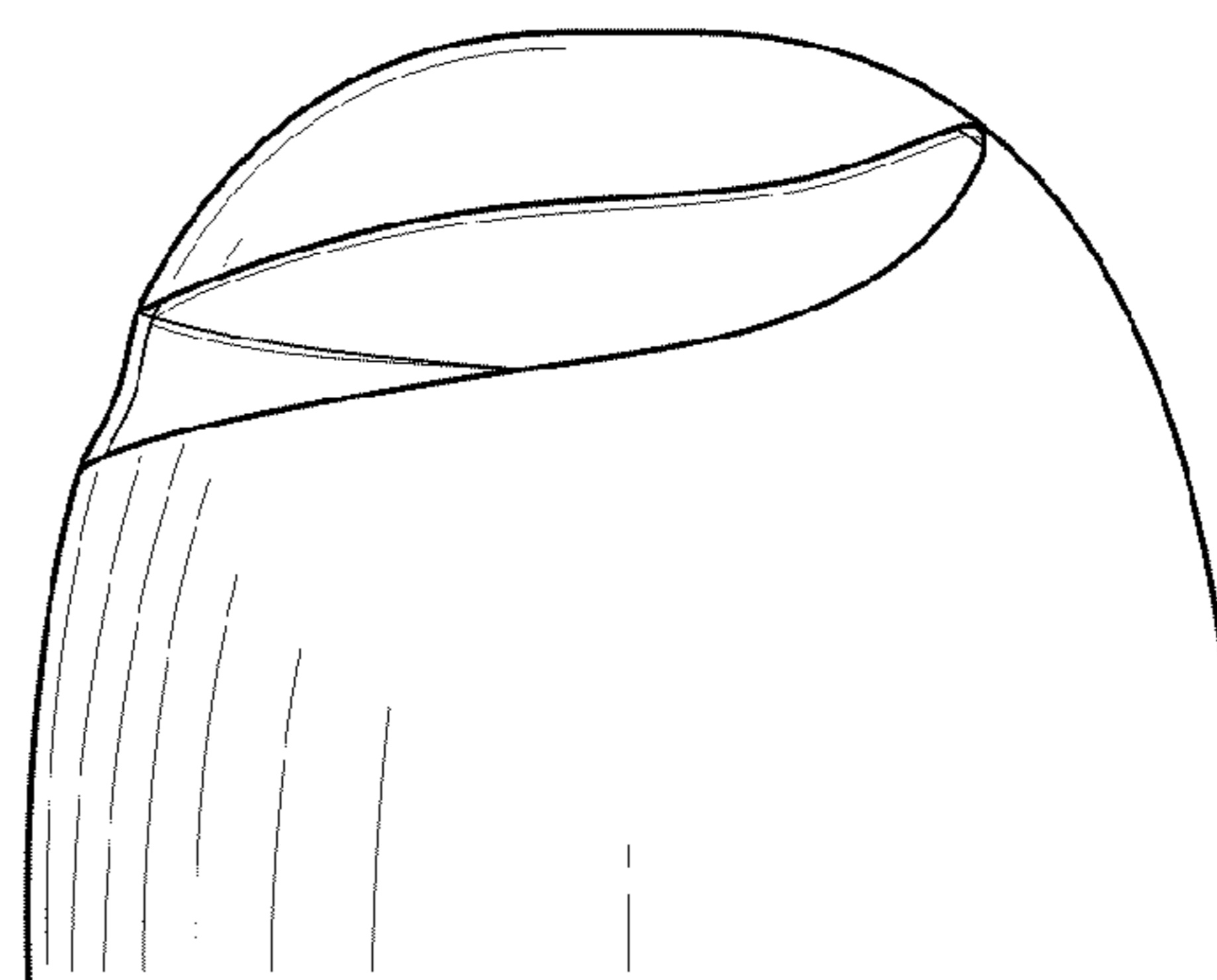

Fig. 26

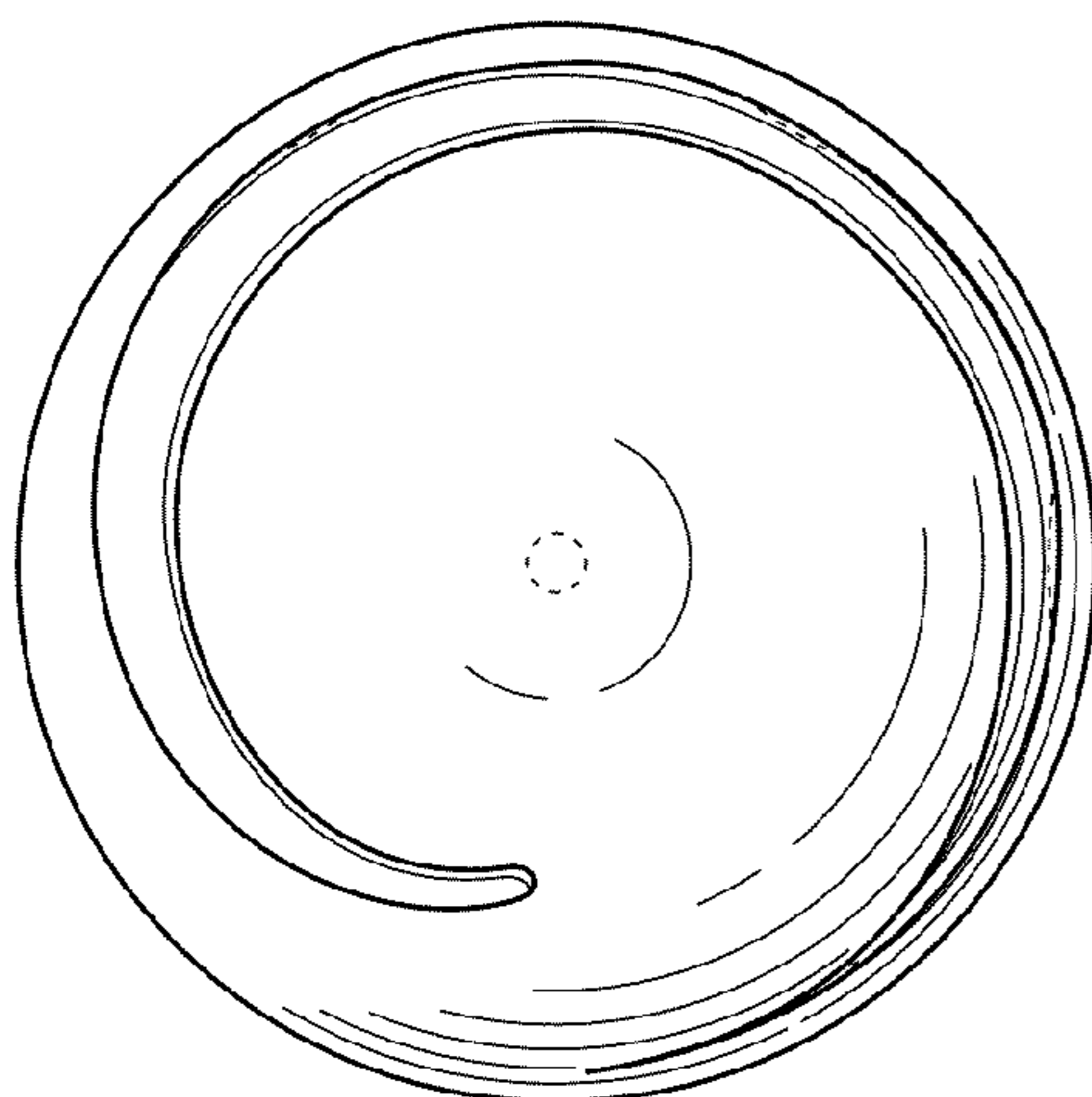

Fig. 27

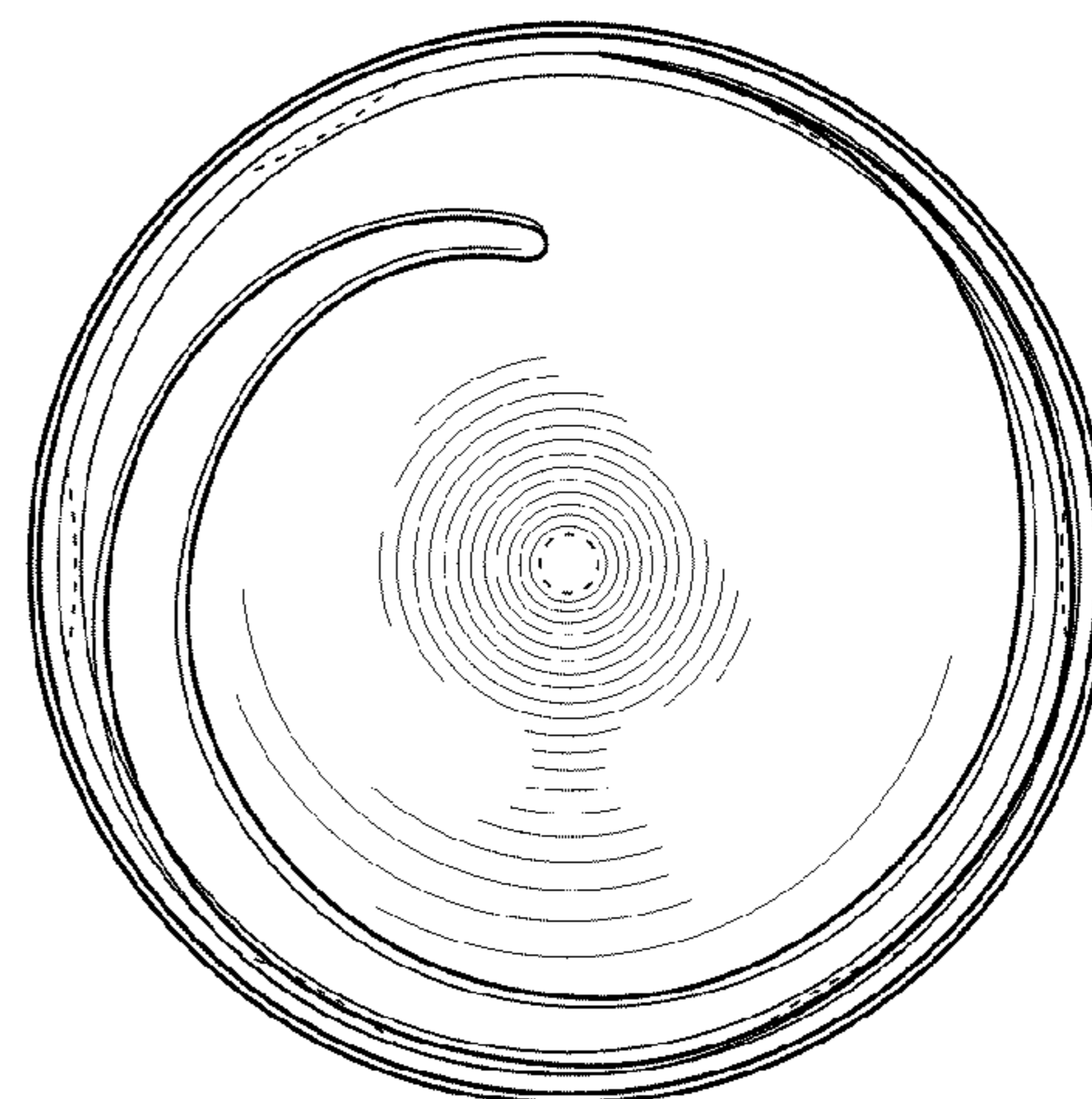

Fig. 28