



US00D645129S

(12) **United States Design Patent**
Lin

(10) **Patent No.:** **US D645,129 S**

(45) **Date of Patent:** **** Sep. 13, 2011**

(54) **HEATER**

(76) **Inventor:** **Hen-Yuan Lin**, New Taipei (TW)

(**) **Term:** **14 Years**

(21) **Appl. No.:** **29/384,199**

(22) **Filed:** **Jan. 28, 2011**

(51) **LOC (9) Cl.** **23-03**

(52) **U.S. Cl.** **D23/342**

(58) **Field of Classification Search** D23/332-350;
392/360, 365-369, 373-376; 126/110 B,
126/90 A, 92 A

See application file for complete search history.

(56) **References Cited**

U.S. PATENT DOCUMENTS

D147,417 S *	9/1947	Palma, Jr.	D23/336
2,606,273 A *	8/1952	Franklin	219/473
D265,121 S *	6/1982	Bergin	D23/348
D504,941 S *	5/2005	Blateri	D23/335
D541,397 S *	4/2007	Chien	D23/335

D545,950 S *	7/2007	Ching et al.	D23/335
D553,719 S *	10/2007	Blateri	D23/337
D601,686 S *	10/2009	Chan	D23/336
D610,664 S *	2/2010	Thomas	D23/343

* cited by examiner

Primary Examiner — T. Chase Nelson

Assistant Examiner — Eric Goodman

(74) *Attorney, Agent, or Firm* — Leong C. Lei

(57) **CLAIM**

The ornamental design for a heater, as shown and described.

DESCRIPTION

FIG. 1 is a perspective view of a heater showing my new design;

FIG. 2 is a front elevational view thereof;

FIG. 3 is a rear elevational view thereof;

FIG. 4 is a left side view thereof;

FIG. 5 is a right side view thereof;

FIG. 6 is a top plan view thereof; and,

FIG. 7 is a bottom plan view thereof while in use.

1 Claim, 7 Drawing Sheets

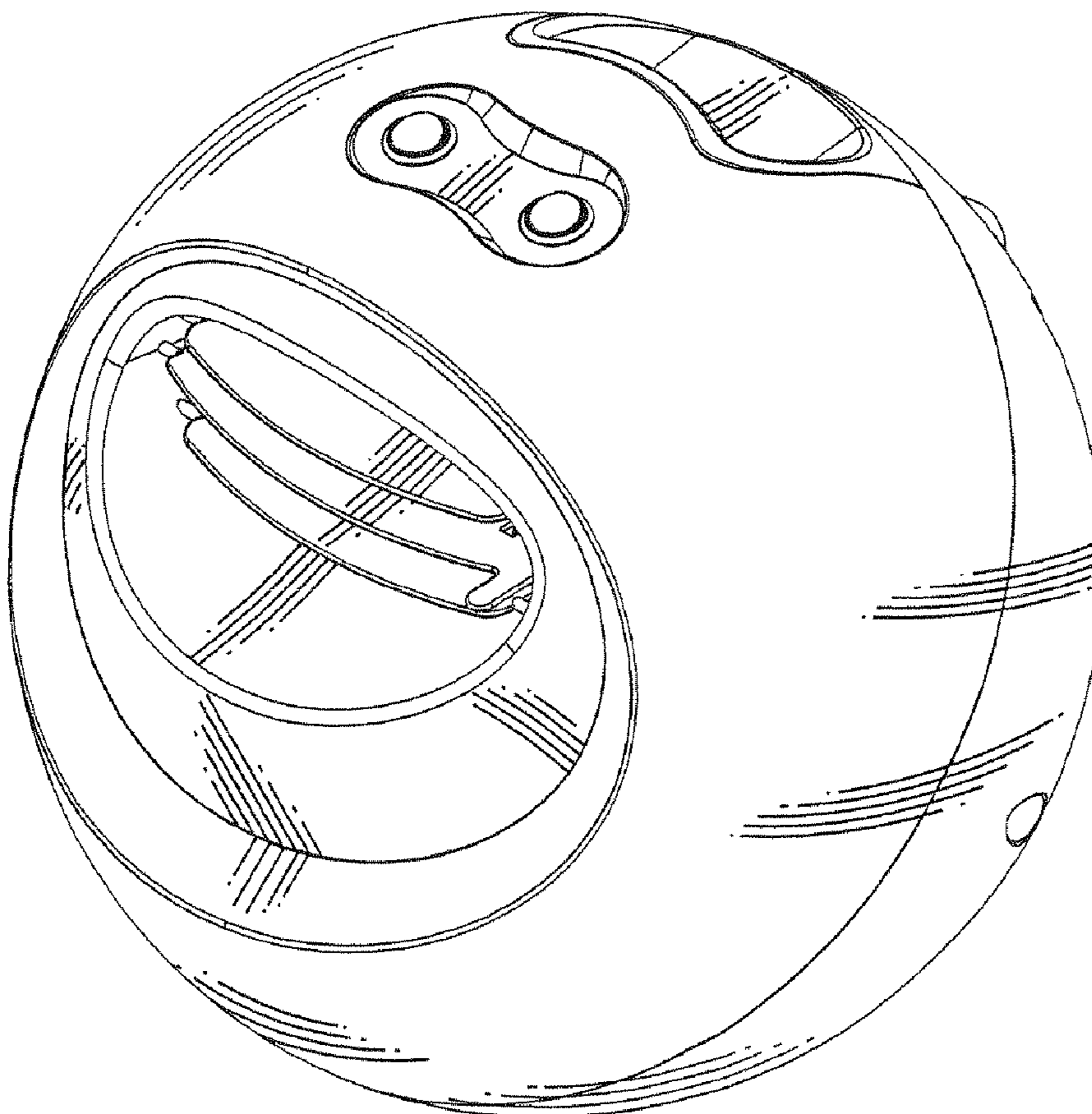

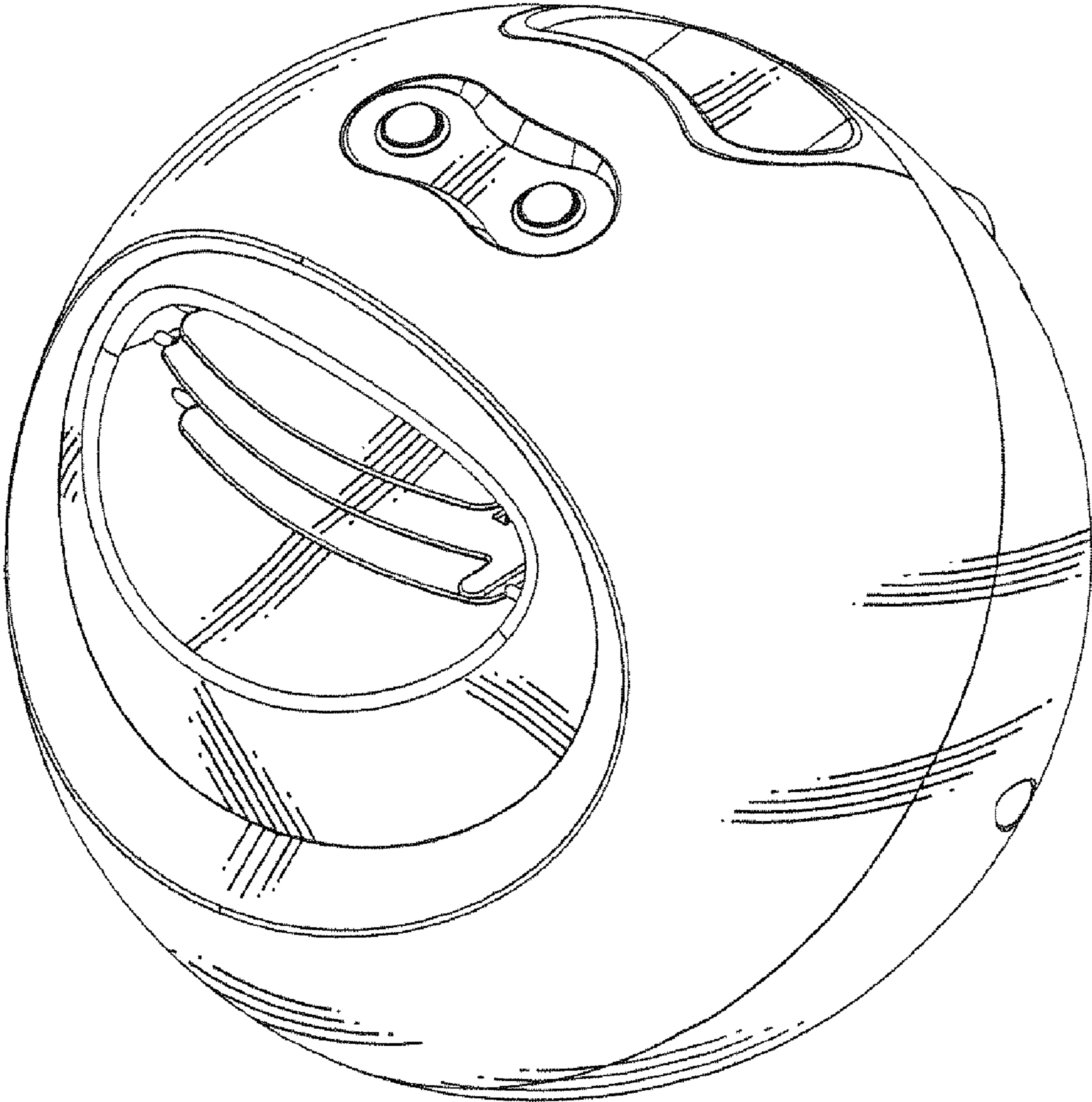

FIG.1

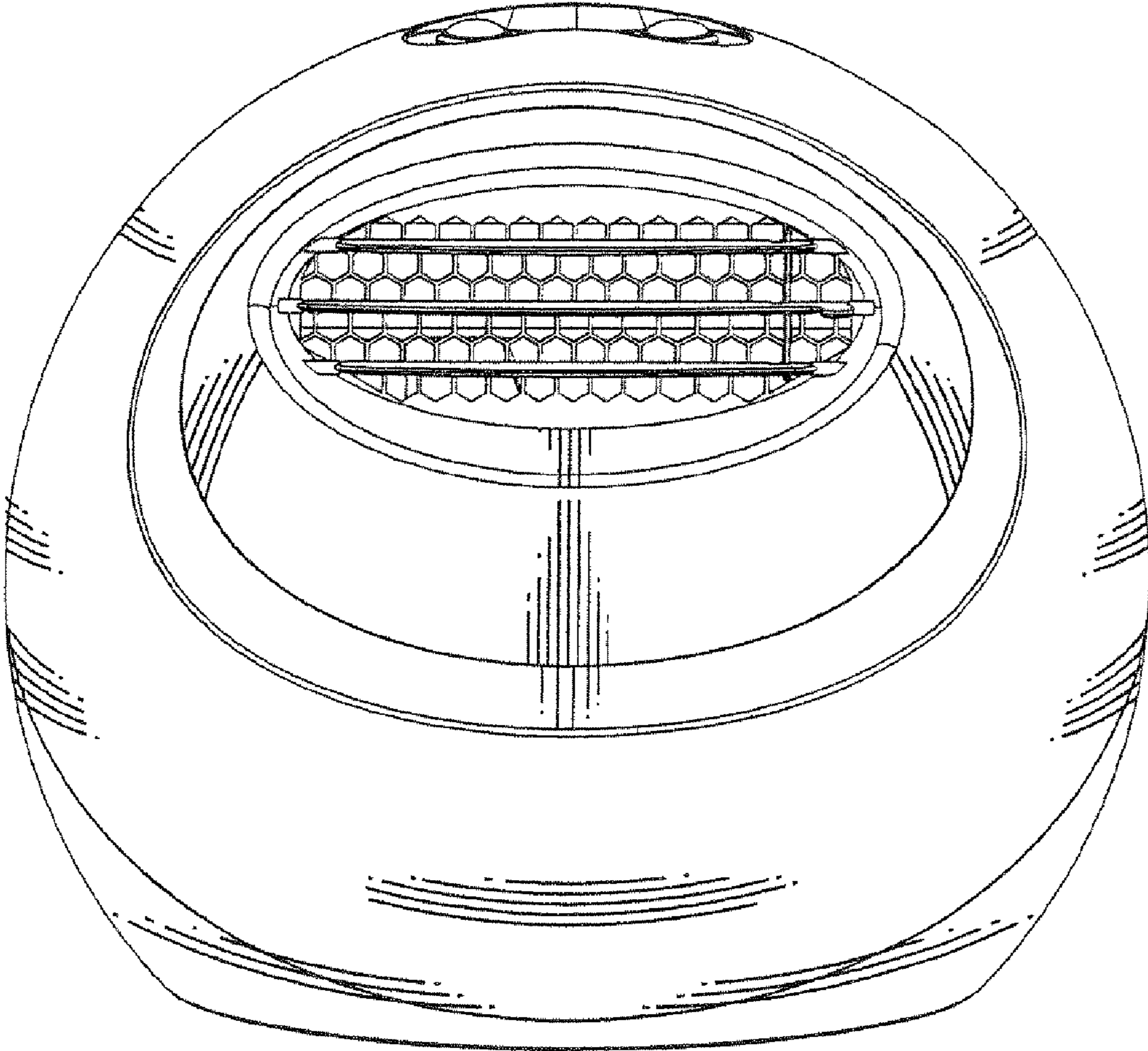

FIG.2

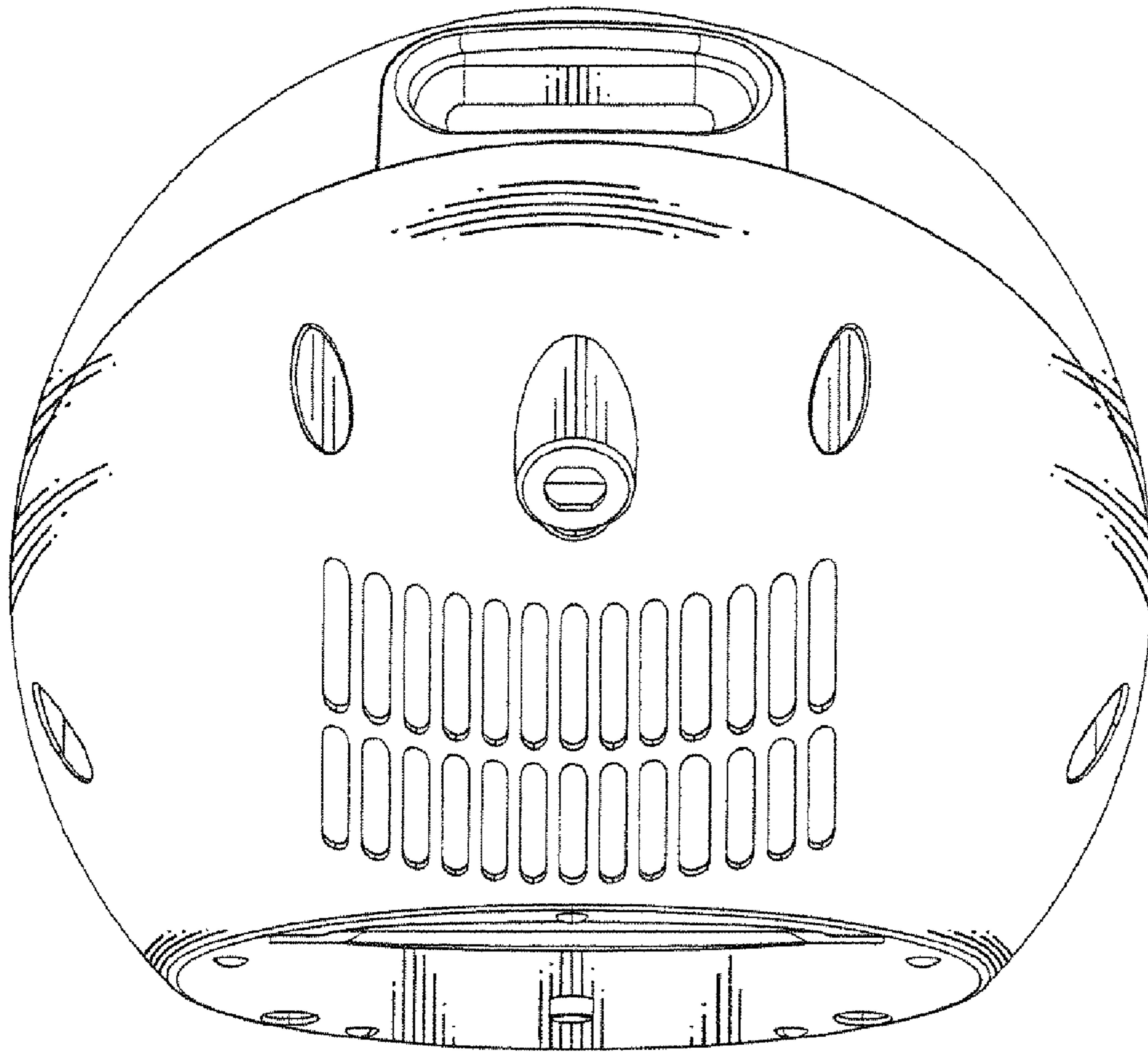

FIG.3

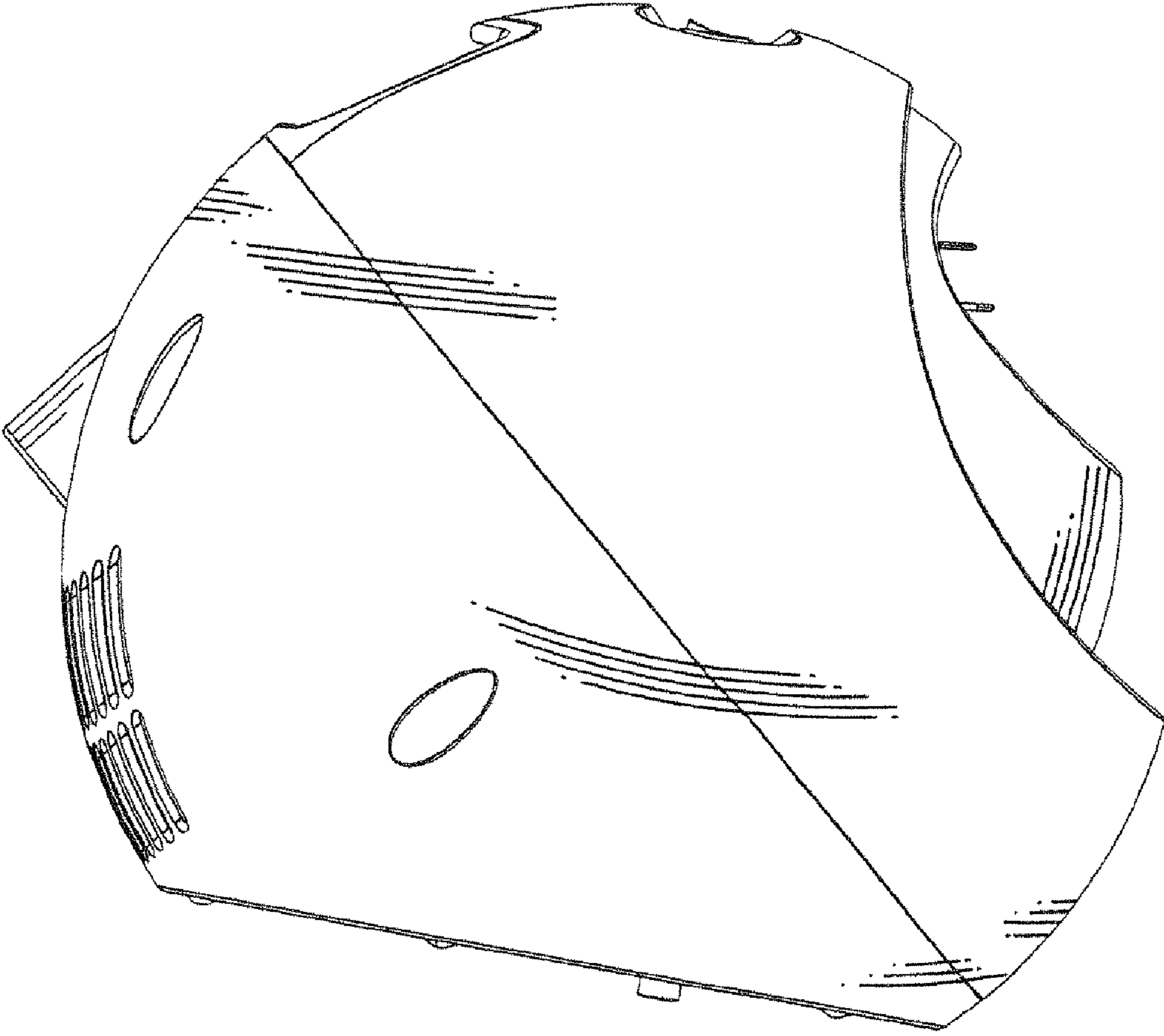

FIG.4

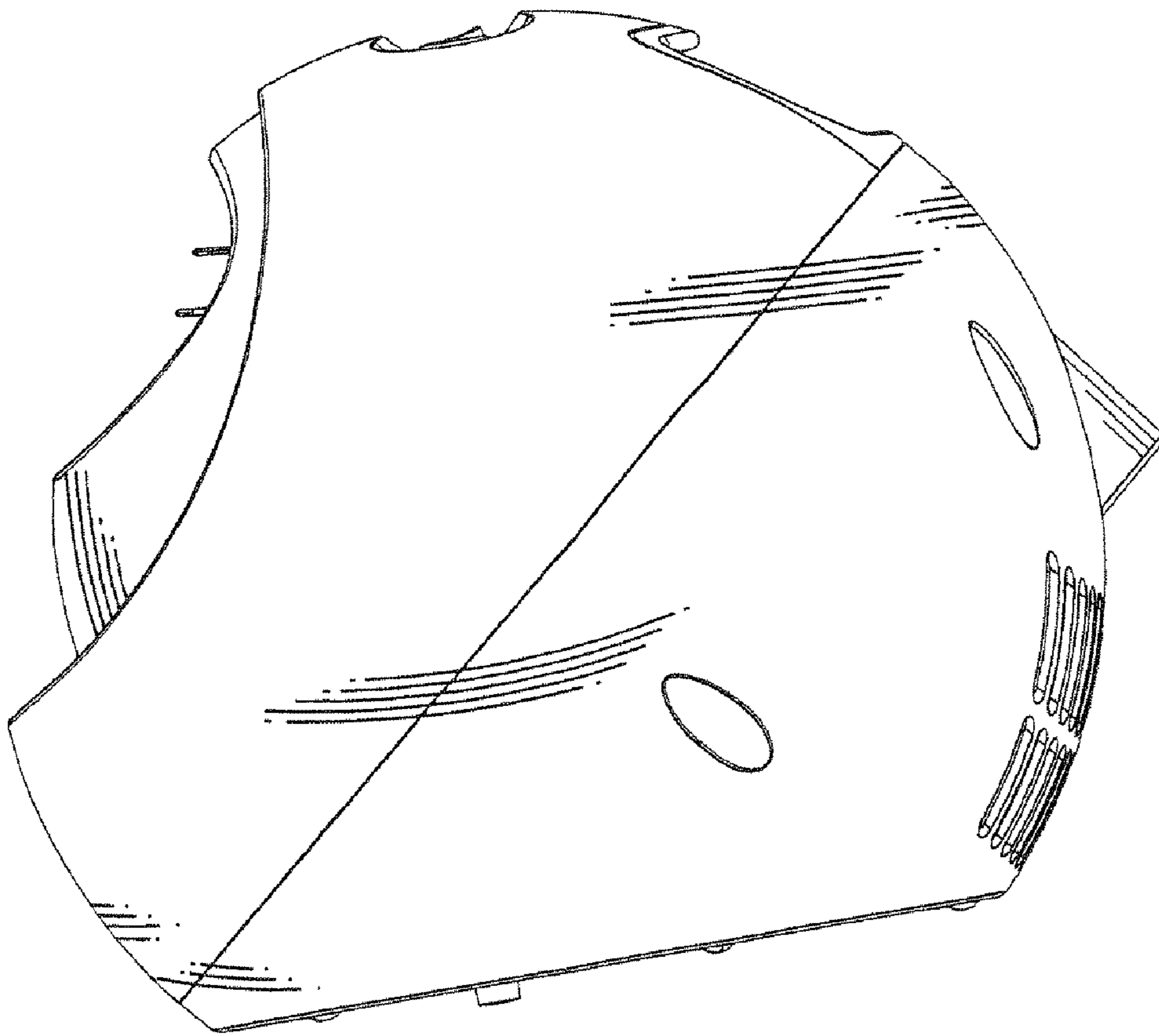

FIG.5

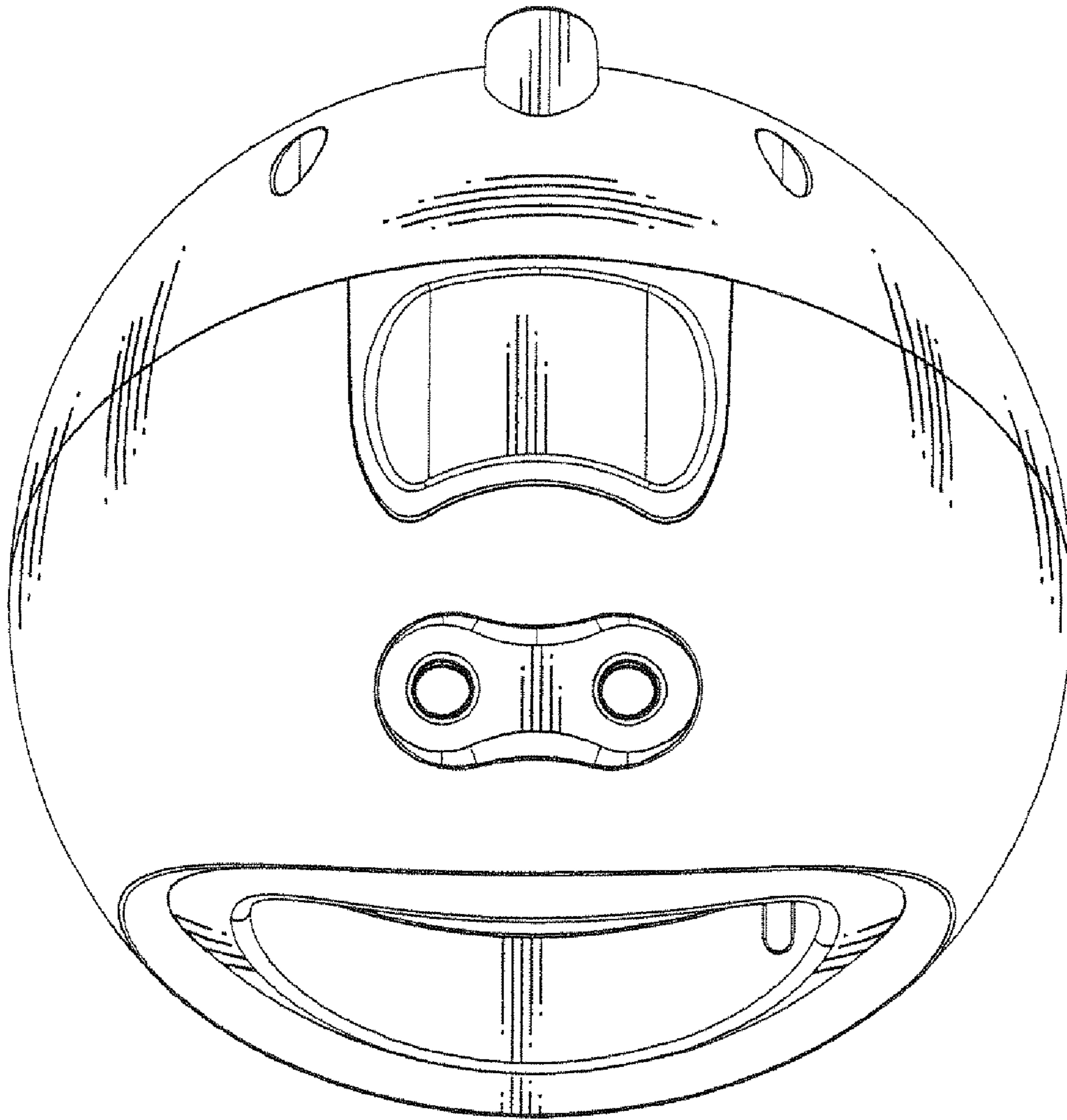

FIG.6

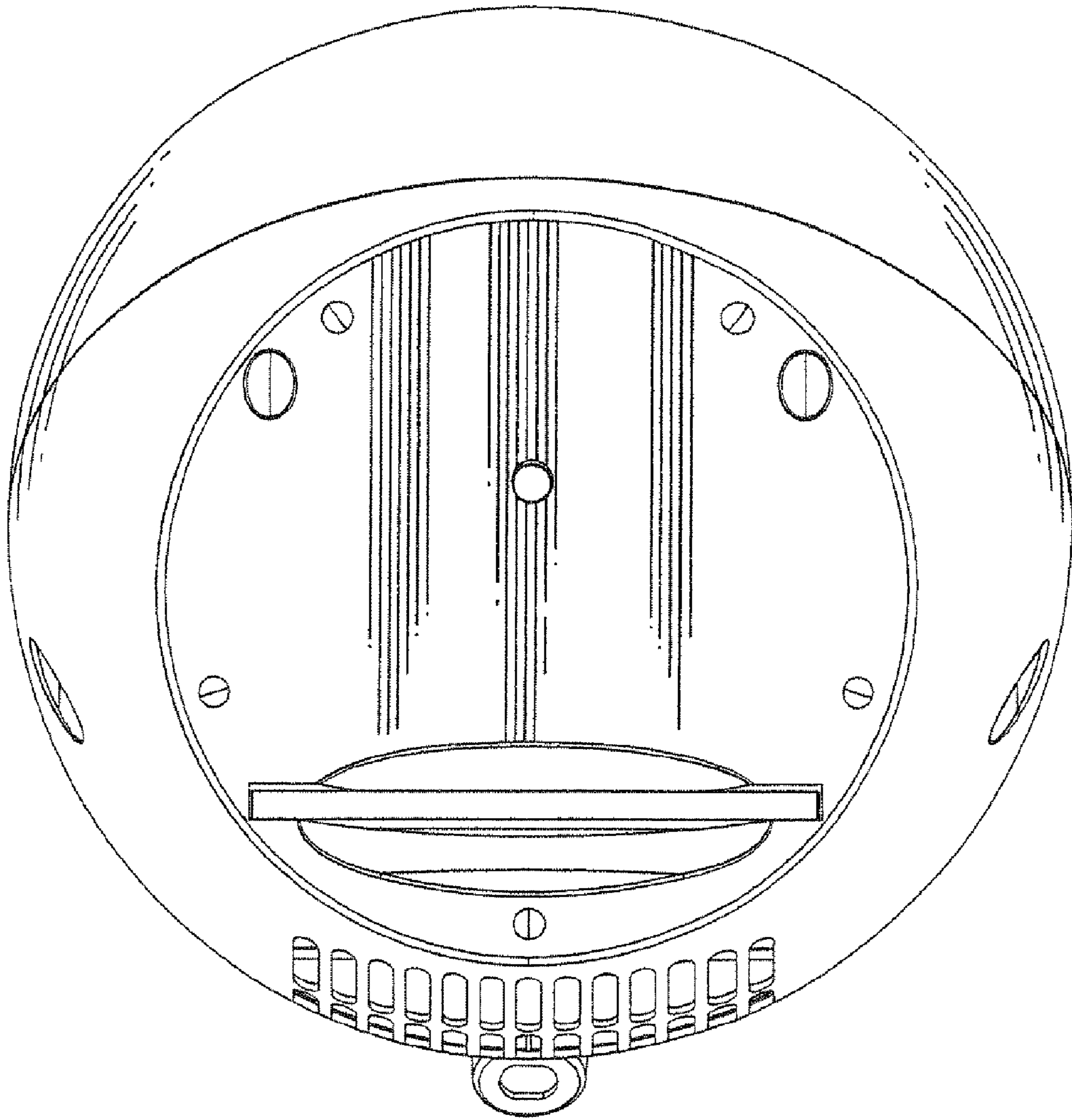

FIG. 7