



US00D645027S

(12) **United States Design Patent**
Gougherty et al.

(10) **Patent No.:** **US D645,027 S**

(45) **Date of Patent:** **** Sep. 13, 2011**

(54) **BASE CRADLE FOR A COMMUNICATIONS HEADSET**

(75) Inventors: **Stefan Gougherty**, Santa Cruz, CA (US); **Manoj Mistry**, Santa Cruz, CA (US); **Casey Peterson**, Scotts Valley, CA (US); **John Kelley**, Santa Cruz, CA (US)

(73) Assignee: **Plantronics, Inc.**, Santa Cruz

(**) Term: **14 Years**

(21) Appl. No.: **29/379,754**

(22) Filed: **Nov. 23, 2010**

(51) **LOC (9) Cl.** **14-01**

(52) **U.S. Cl.** **D14/224; D14/223**

(58) **Field of Classification Search** D14/205, D14/206, 223, 435.1, 214, 137, 224, 224.1, D14/168, 149, 253; 320/107, 108, 110, 111, 320/113, 115

See application file for complete search history.

(56) **References Cited**

U.S. PATENT DOCUMENTS

D147,151 S *	7/1947	Schinske	D13/107
D300,214 S *	3/1989	Adams	D13/108
D301,456 S *	6/1989	Siddoway	D13/107
D322,061 S *	12/1991	Watanabe	D13/108
D323,504 S *	1/1992	Langton	D14/142
D335,861 S *	5/1993	Tattari	D13/108
5,619,397 A *	4/1997	Honda et al.	361/679.43
D414,180 S *	9/1999	Waldner	D14/149
D433,005 S *	10/2000	McGugan	D14/155
D462,331 S *	9/2002	Fukumori et al.	D13/161
D471,548 S *	3/2003	Zheng	D14/253
D472,900 S *	4/2003	Matsumoto	D14/447

D483,016 S *	12/2003	Ma et al.	D13/108
D486,492 S *	2/2004	Sheu et al.	D14/434
D489,323 S *	5/2004	Yoshida	D13/108
D496,029 S *	9/2004	Skulley et al.	D14/224
D506,437 S *	6/2005	Nishizawa	D13/108
D507,526 S *	7/2005	Ohta	D13/108
D513,411 S *	1/2006	Beasley et al.	D14/149
D523,847 S *	6/2006	Naruki	D14/224.1
D534,489 S *	1/2007	Klein et al.	D13/108
D535,943 S *	1/2007	Kurihara	D13/108
D541,741 S *	5/2007	Yosef et al.	D13/110
D564,501 S *	3/2008	Rath	D14/224
D584,731 S *	1/2009	Montgomery et al.	D14/434
D589,031 S *	3/2009	Bentley et al.	D14/224
D590,369 S *	4/2009	Gonser et al.	D14/149
D593,998 S *	6/2009	Bentley et al.	D14/224
D609,707 S *	2/2010	Lee	D14/434

* cited by examiner

Primary Examiner — Paula Greene

(74) *Attorney, Agent, or Firm* — Michael D. Rodriguez

(57) **CLAIM**

The ornamental design for a base for a communications headset, as shown and described.

DESCRIPTION

FIG. 1 is front-right perspective view of a base cradle for a communications headset showing our new design;

FIG. 2 is a top view thereof;

FIG. 3 is a bottom view thereof;

FIG. 4 is a back view thereof;

FIG. 5 is a front view thereof;

FIG. 6 is a right side view thereof; and,

FIG. 7 is a left side view thereof.

The broken line showing of the unclaimed environment forms no part of the claimed design.

1 Claim, 2 Drawing Sheets

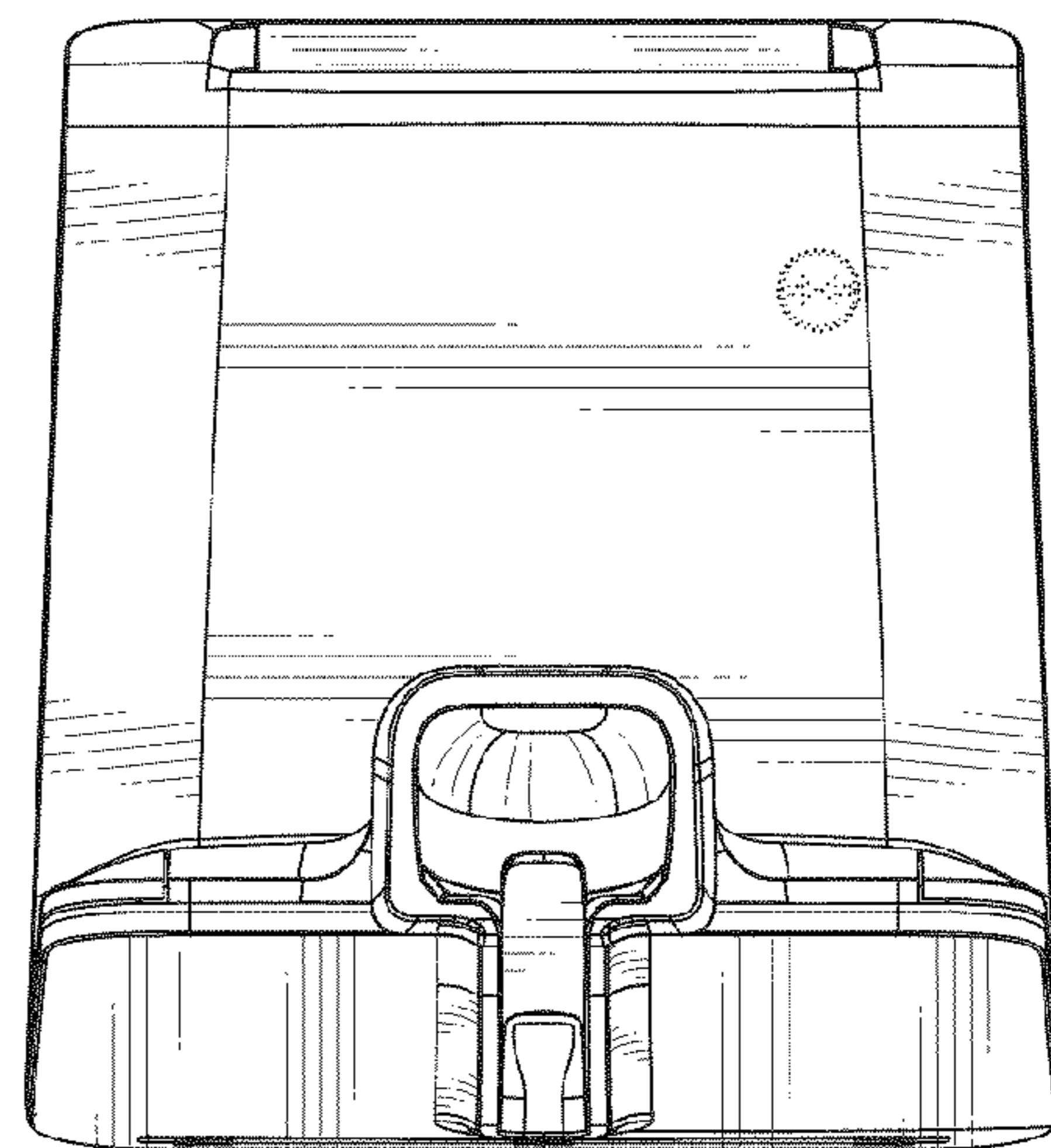
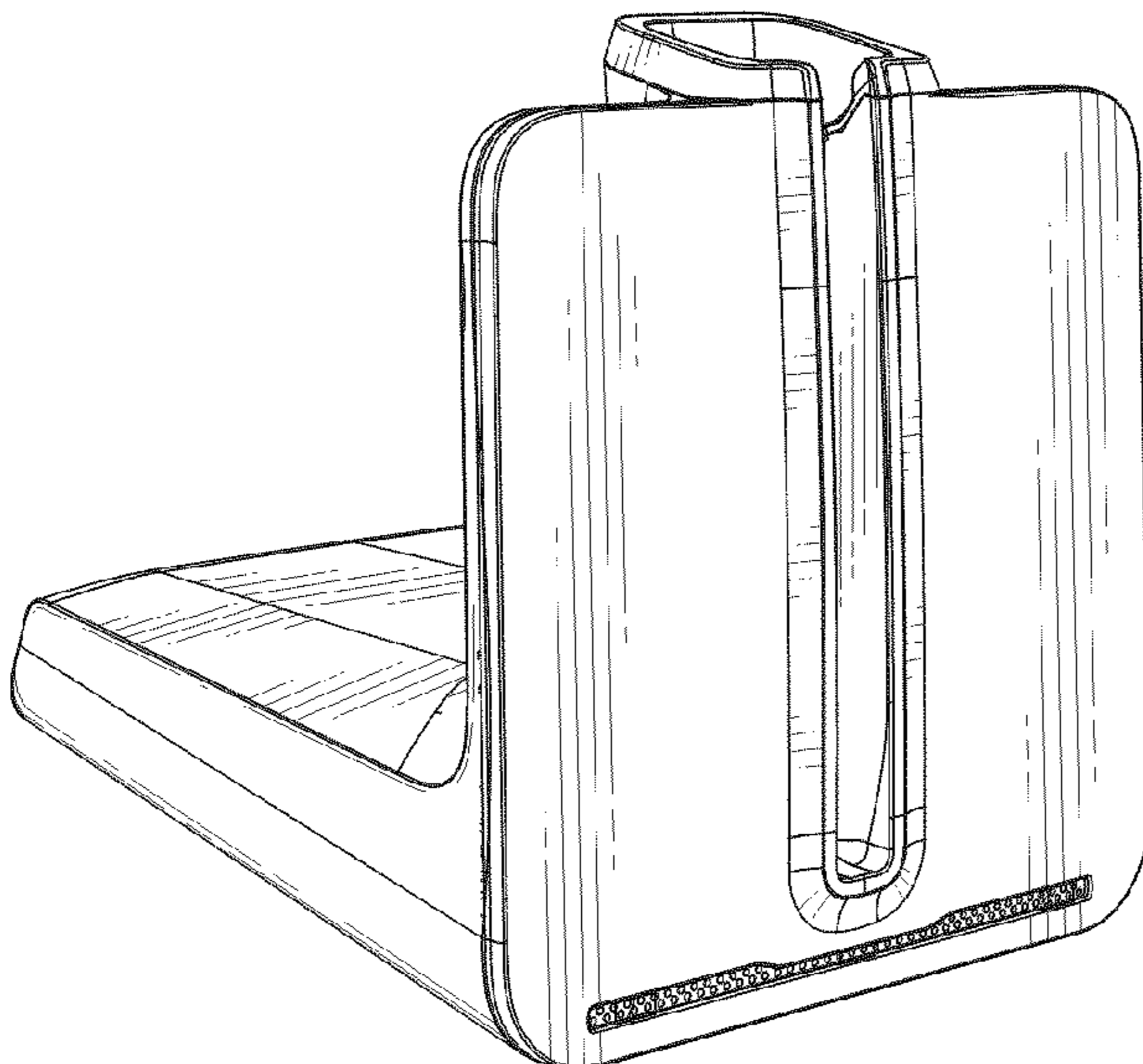

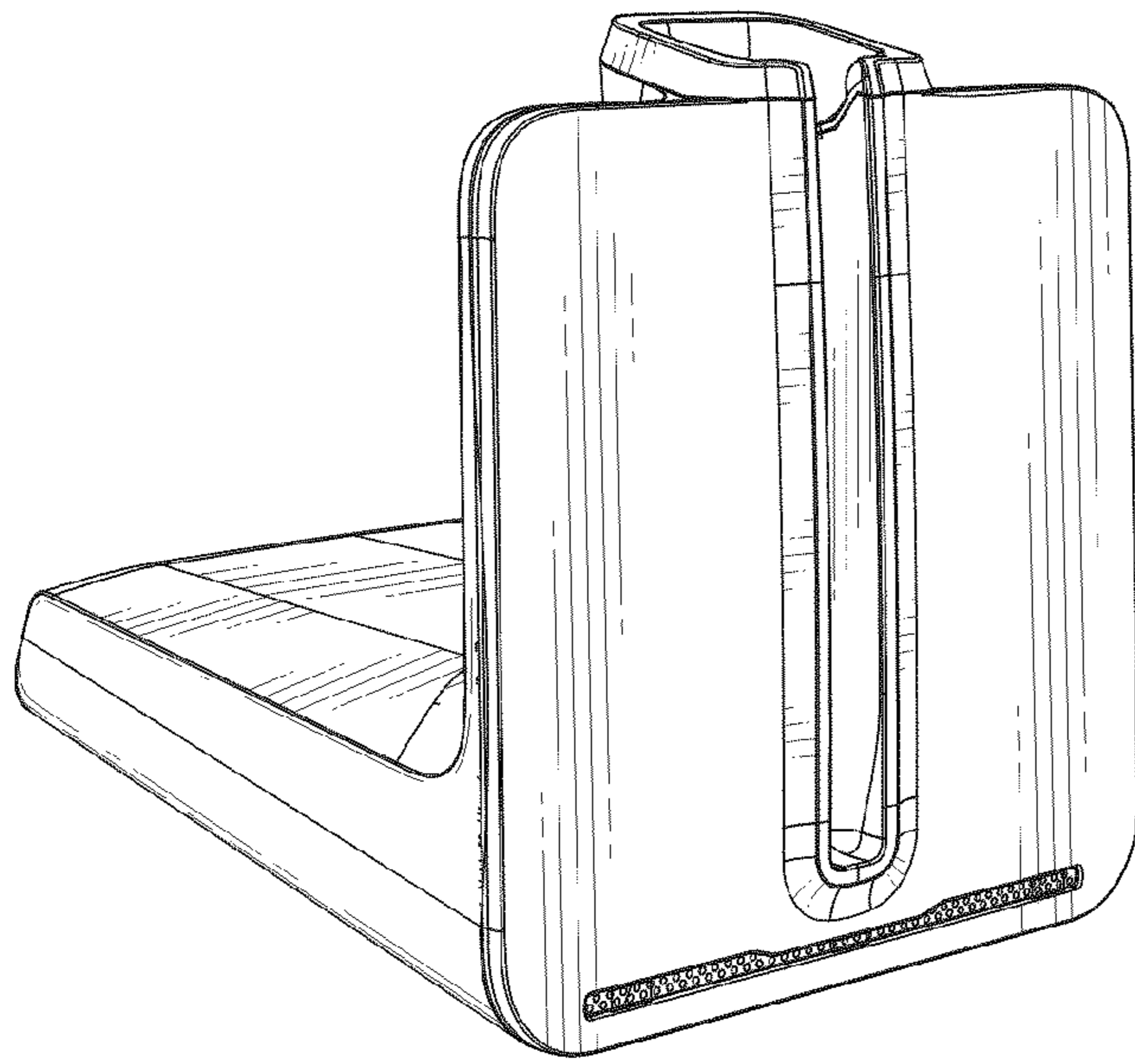

FIG. 1

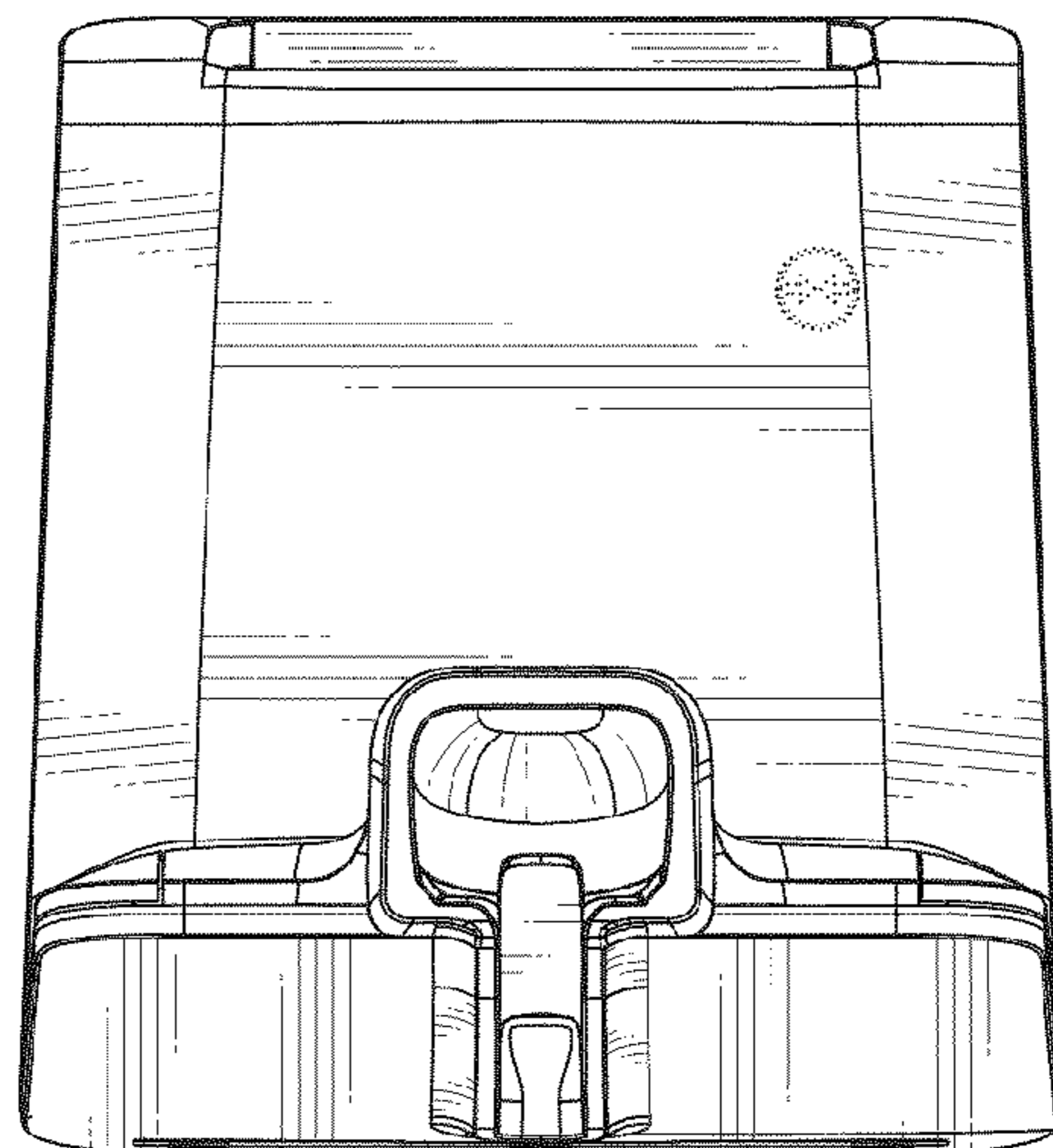

FIG. 2

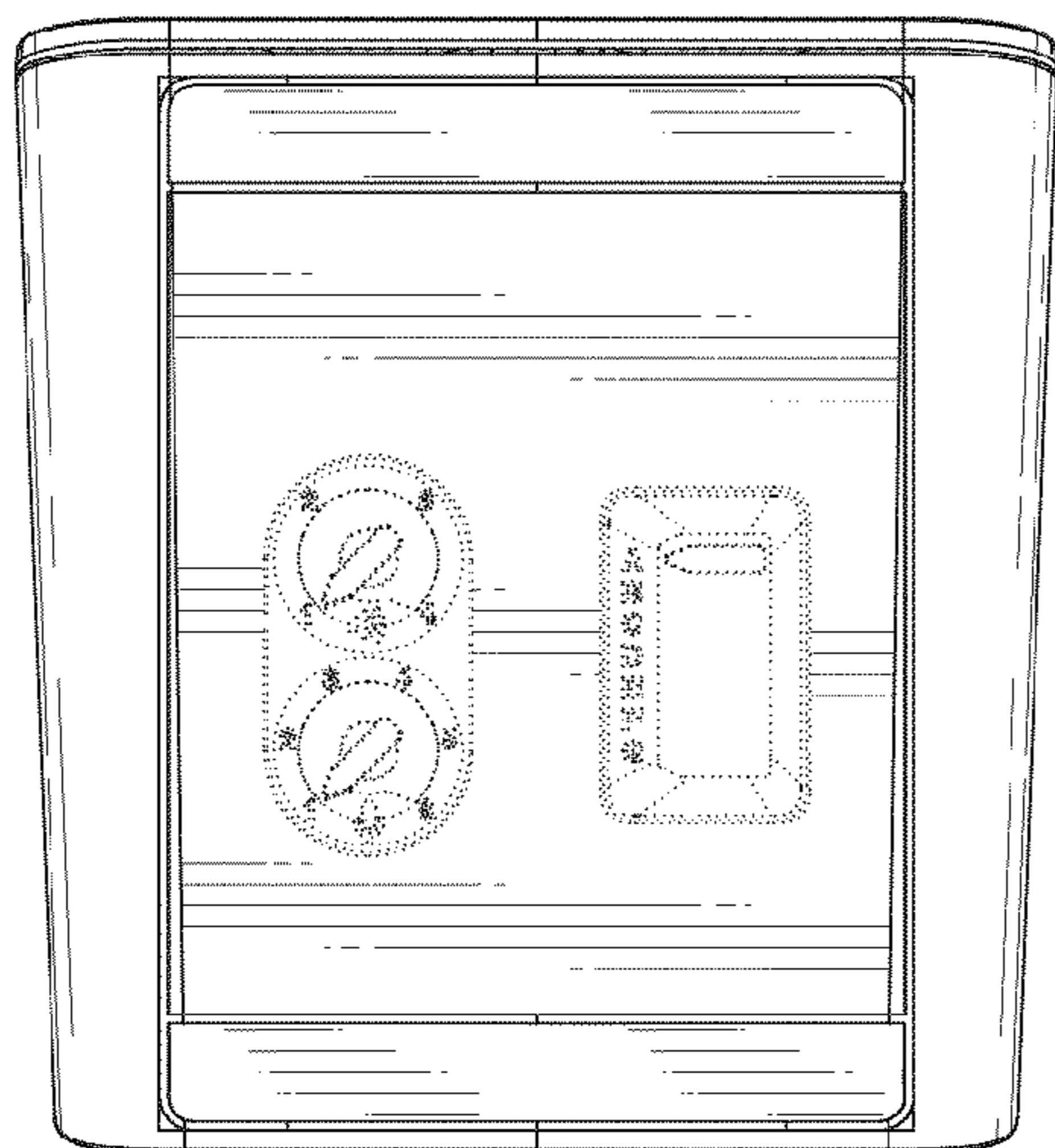

FIG. 3

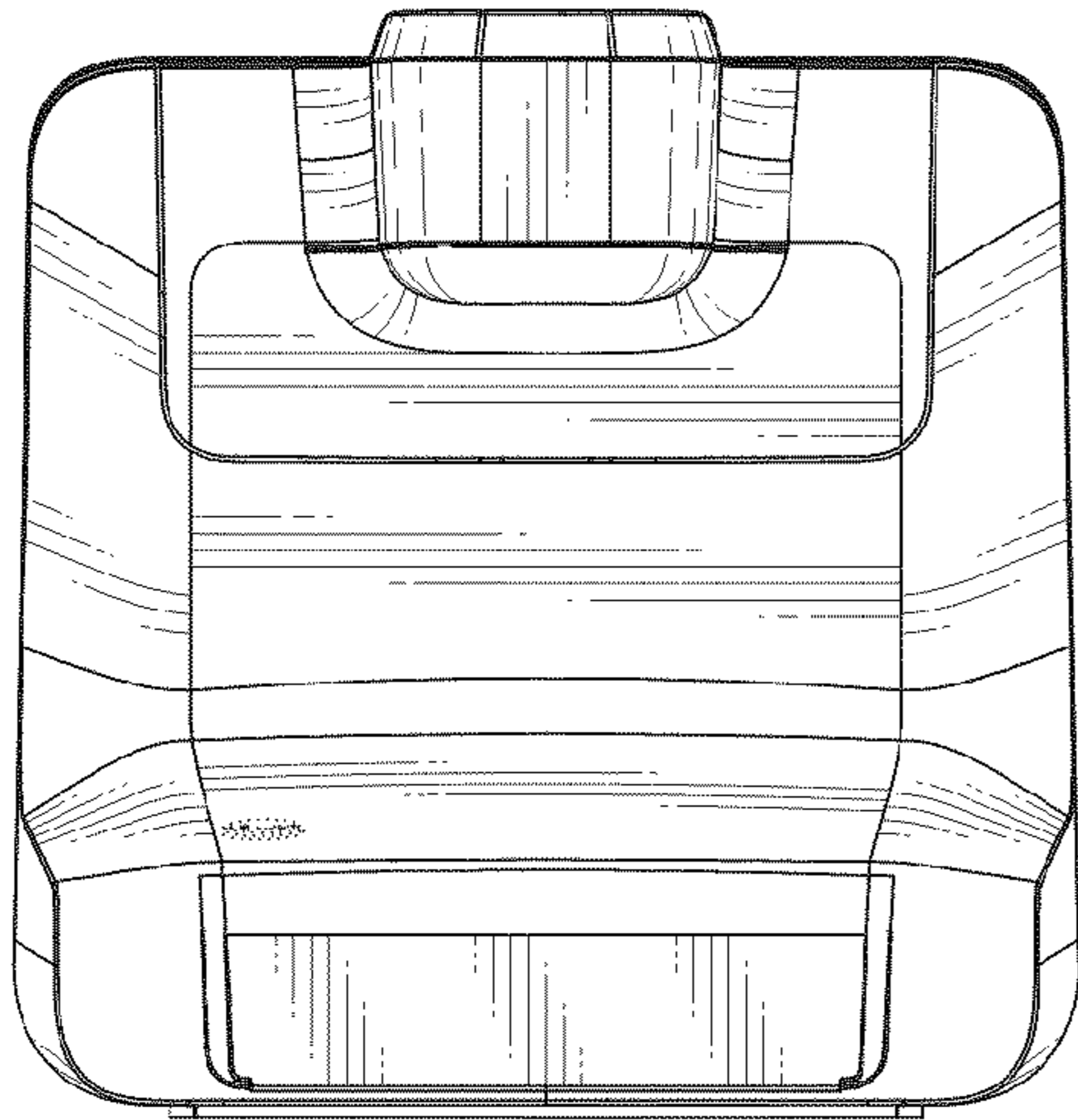

FIG. 4

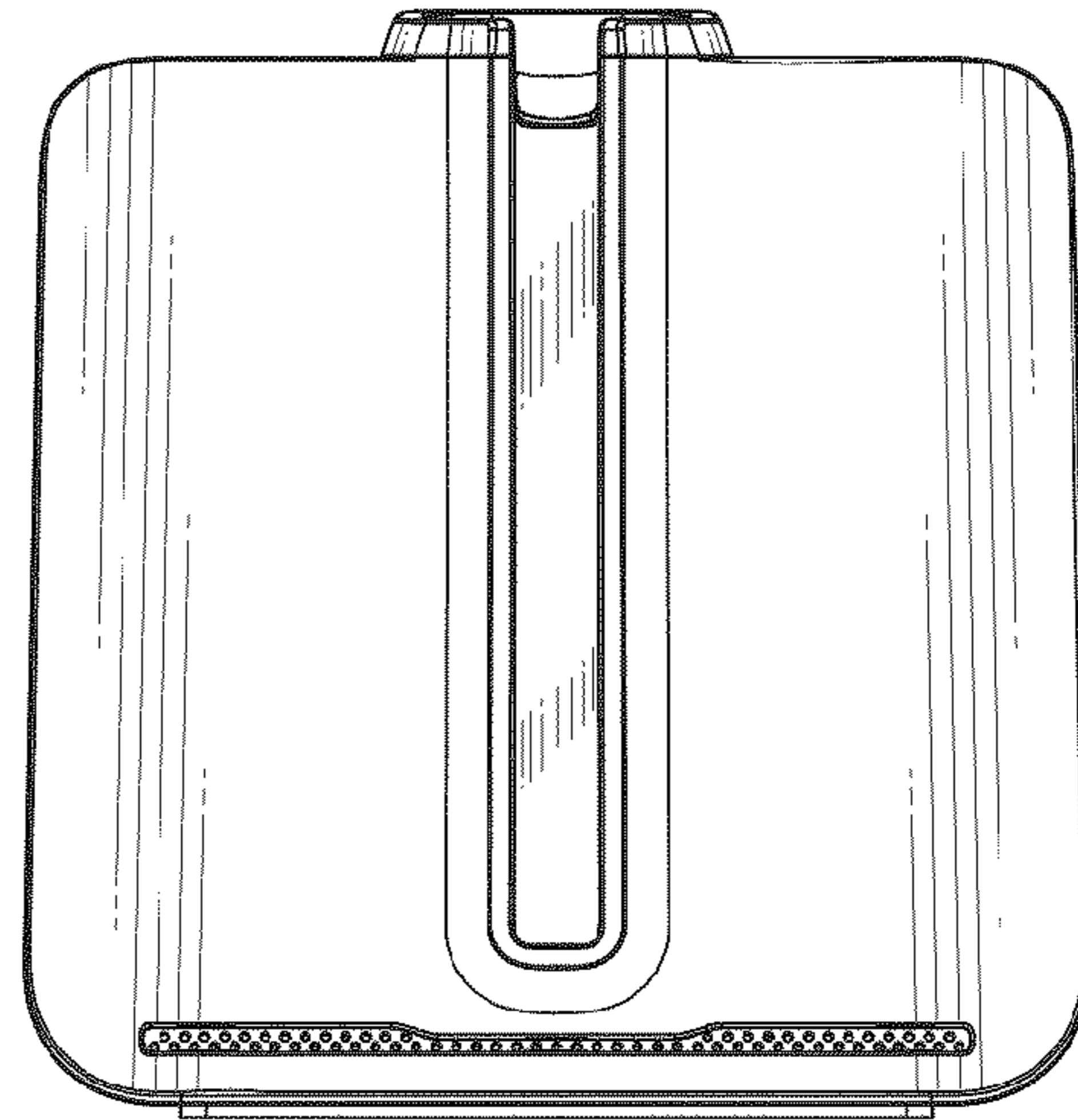

FIG. 5

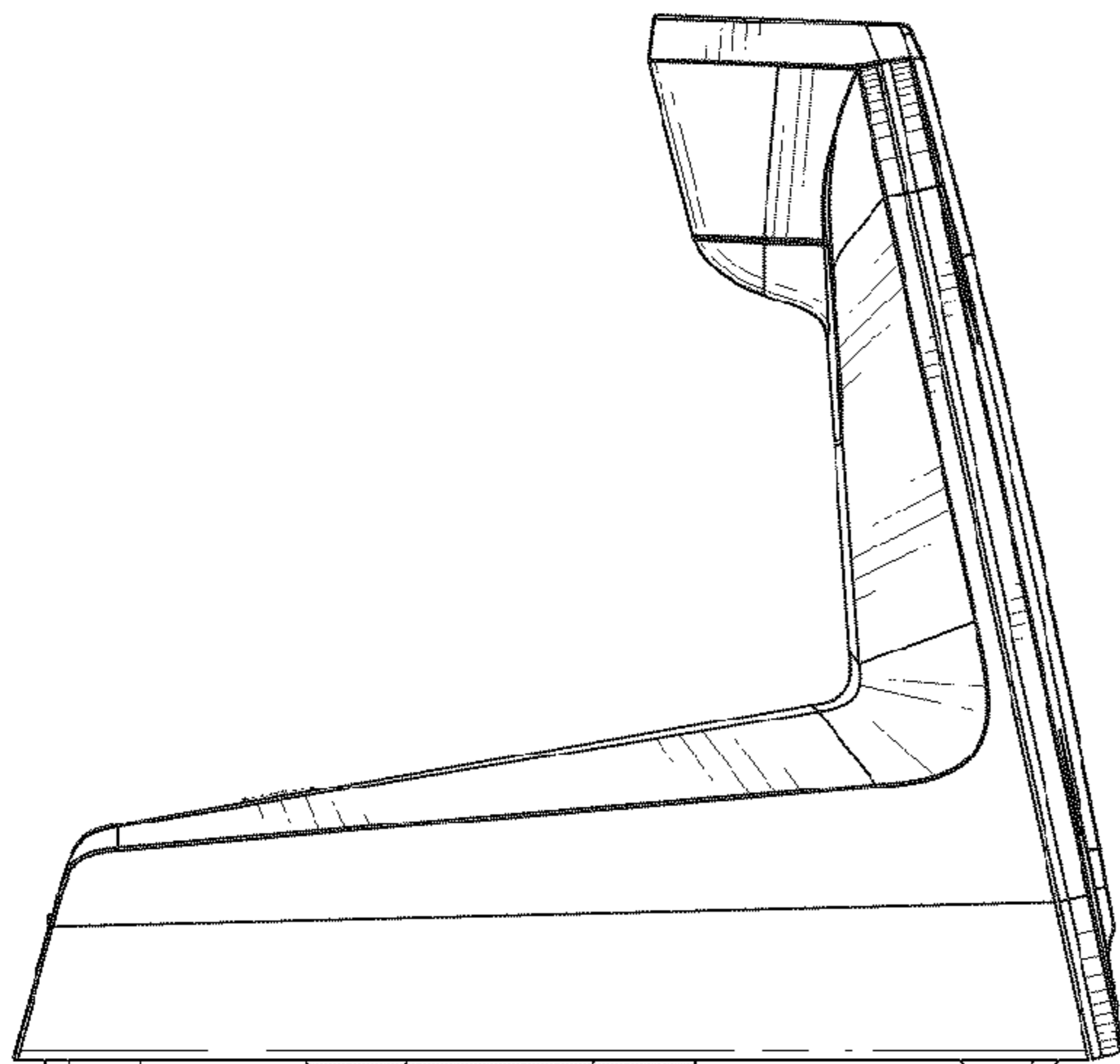

FIG. 6

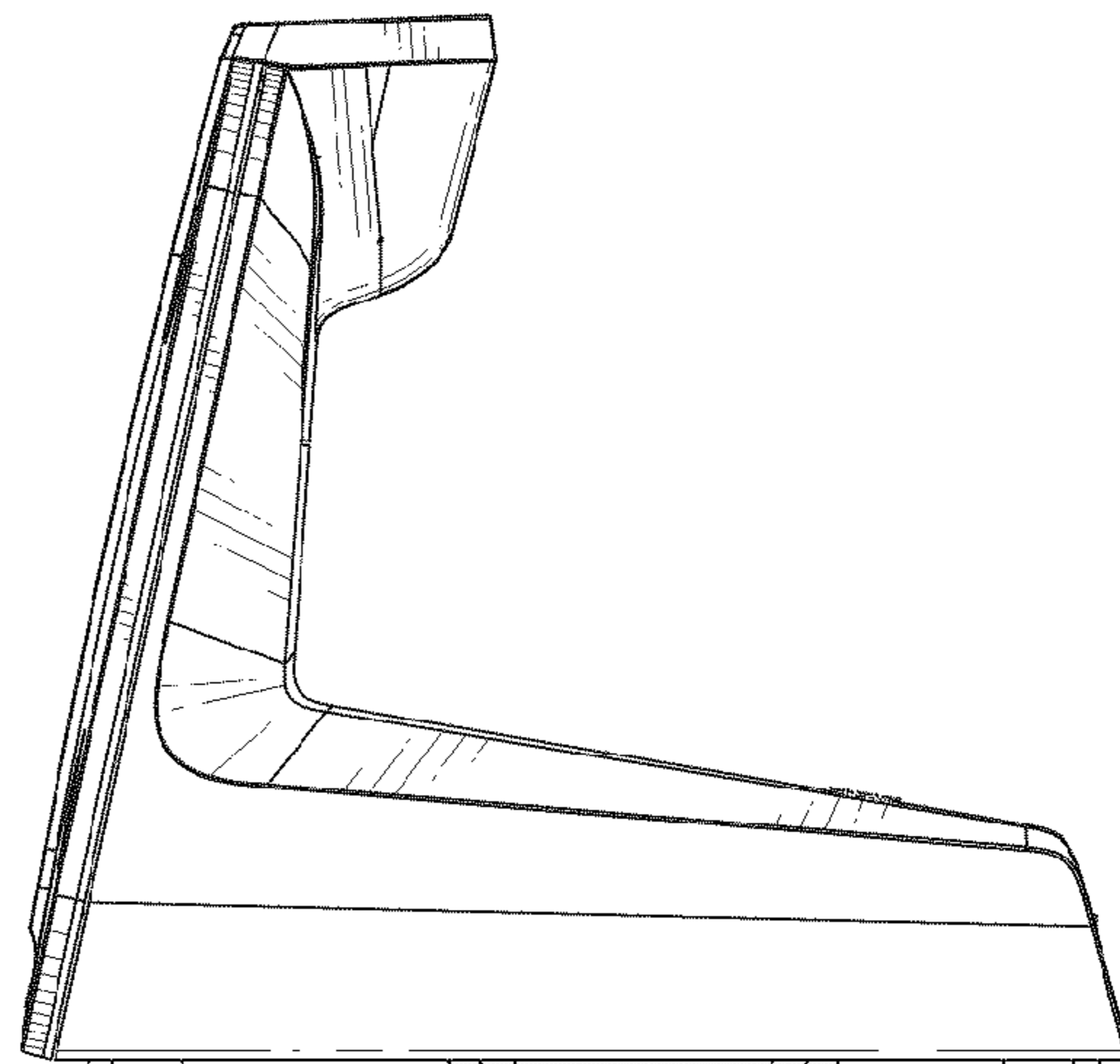

FIG. 7