



US00D644848S

(12) **United States Design Patent**
Lewis

(10) **Patent No.:** **US D644,848 S**

(45) **Date of Patent:** **** Sep. 13, 2011**

(54) **CHAISE LOUNGE**

(76) **Inventor:** **Sally Sirkin Lewis**, Beverly Hills, CA
(US)

(**) **Term:** **14 Years**

(21) **Appl. No.:** **29/376,665**

(22) **Filed:** **Oct. 8, 2010**

(51) **LOC (9) Cl.** **06-01**

(52) **U.S. Cl.** **D6/361**

(58) **Field of Classification Search** D6/334,
D6/335, 336, 361, 374, 375, 377, 379, 381,
D6/500-502; 297/232, 423.1, 445.1, 446.1;
5/12.1, 652

See application file for complete search history.

(56) **References Cited**

U.S. PATENT DOCUMENTS

D366,571 S *	1/1996	Hutton	D6/361
D434,237 S *	11/2000	Binder et al.	D6/361
D437,128 S *	2/2001	Binder et al.	D6/361

D454,439 S *	3/2002	Hutton	D6/361
D505,560 S *	5/2005	Hutton et al.	D6/361
D579,222 S *	10/2008	Schmitt	D6/361

* cited by examiner

Primary Examiner — Mimoso De

(74) *Attorney, Agent, or Firm* — Cox Smith Matthews Incorporated

(57) **CLAIM**

The ornamental design for a chaise lounge, as shown and described.

DESCRIPTION

FIG. 1 is a perspective view of the chaise lounge of my design; FIG. 2 is a top view of the chaise lounge; FIG. 3 is a front view of the chaise lounge; FIG. 4 is a back side view of the chaise lounge; FIG. 5 is a right side view of the chaise lounge (the left side view, being a mirror image of the right side view, is not shown); and, FIG. 6 is a bottom view of the chaise lounge.

1 Claim, 3 Drawing Sheets

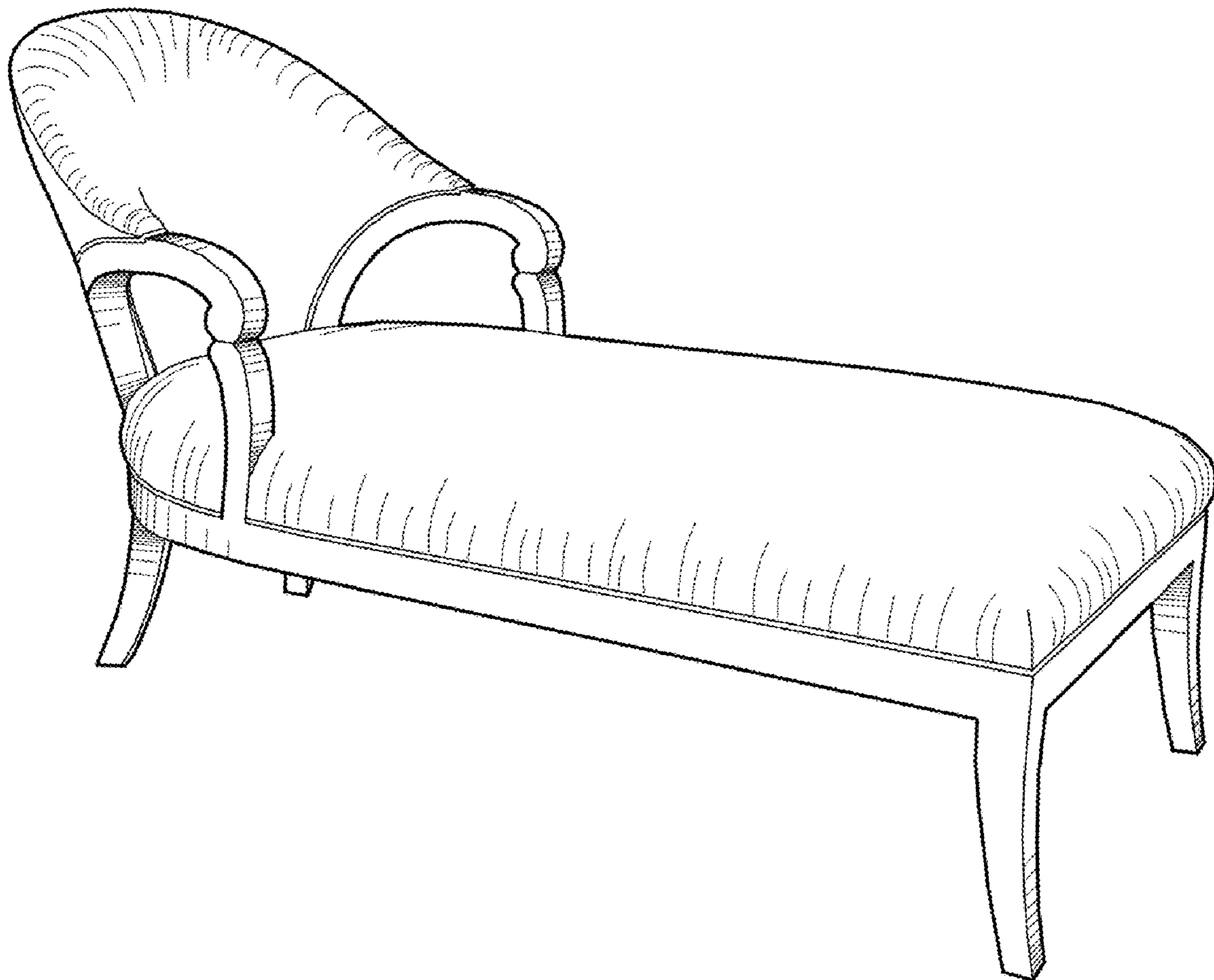

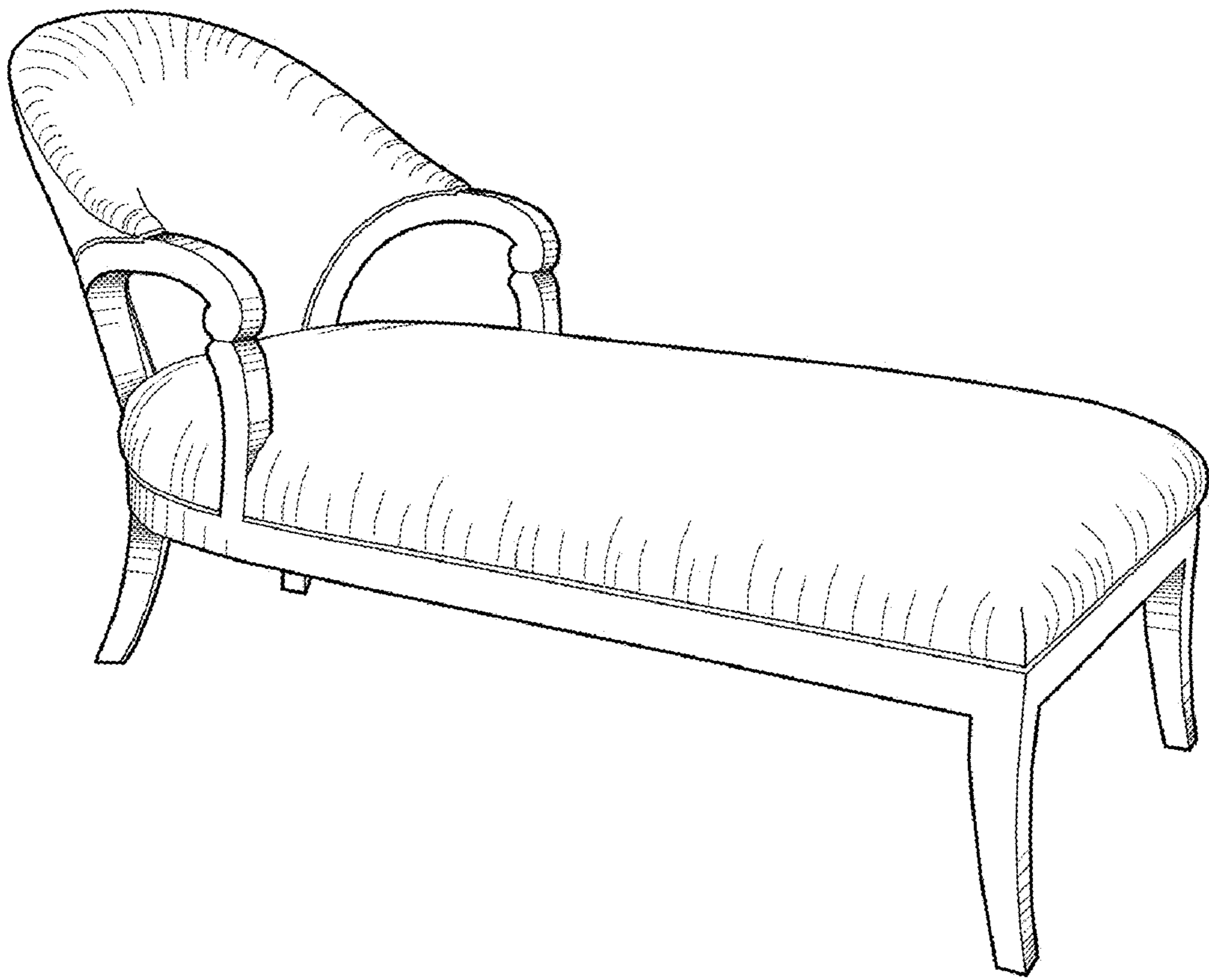

FIG. 1

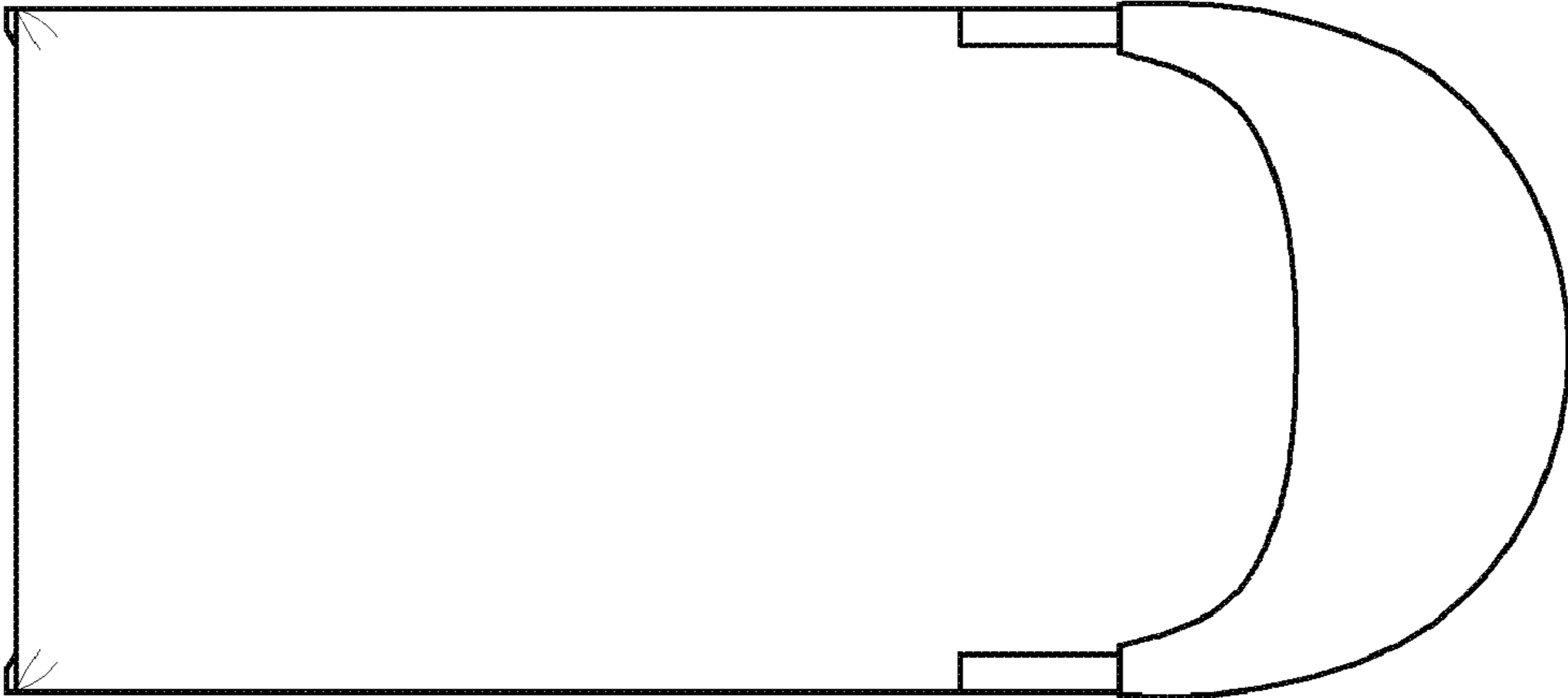

FIG. 2

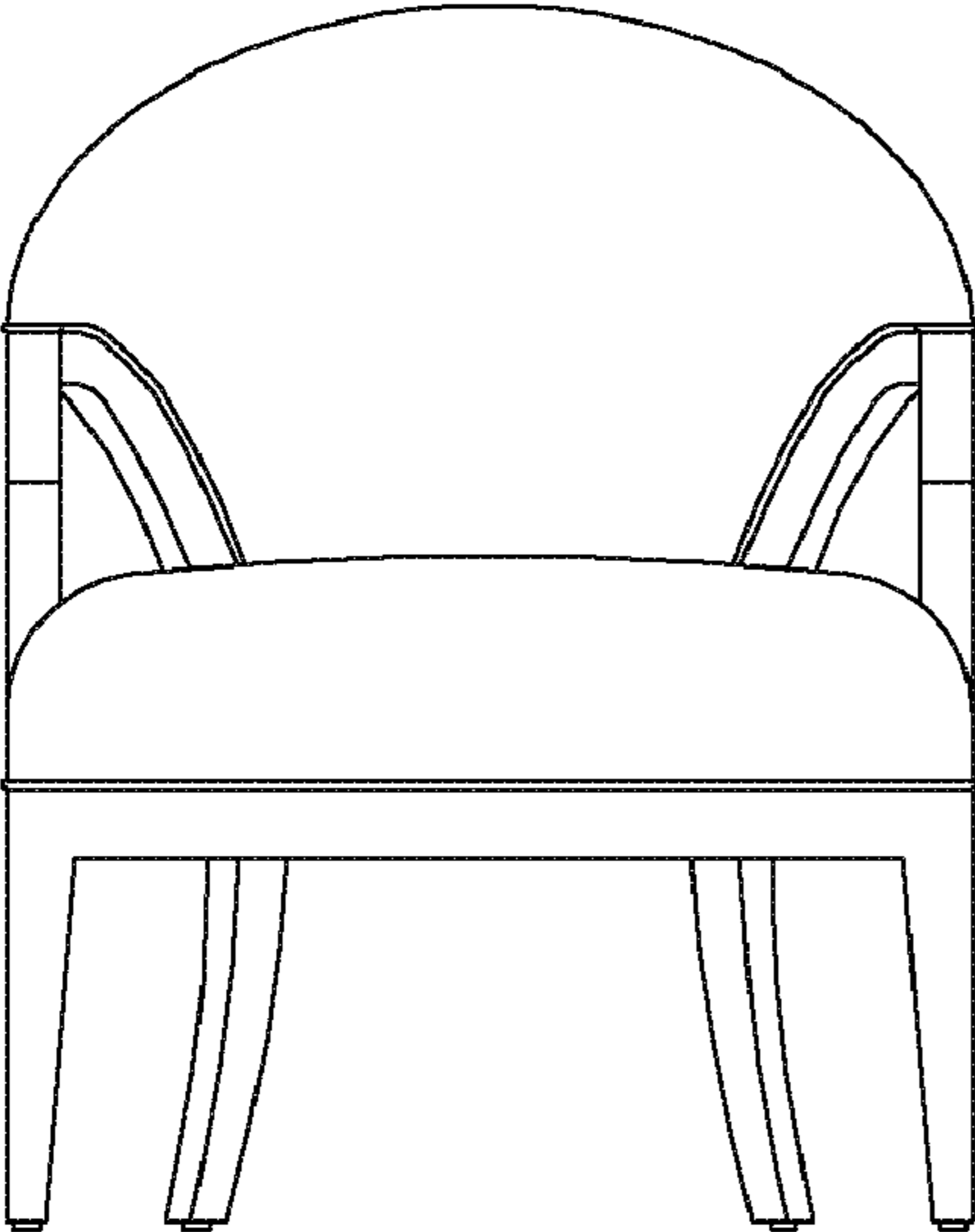

FIG. 3

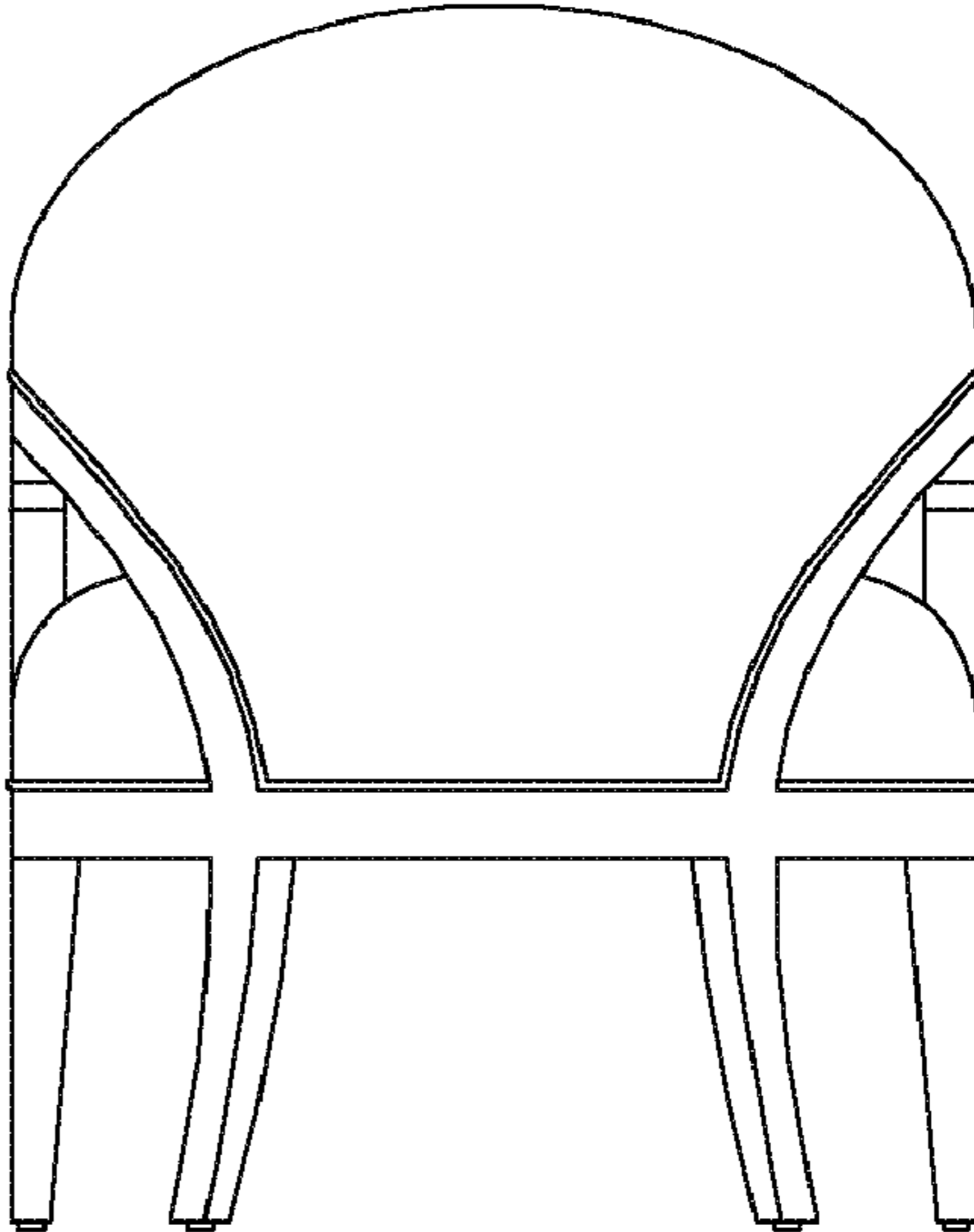

FIG. 4

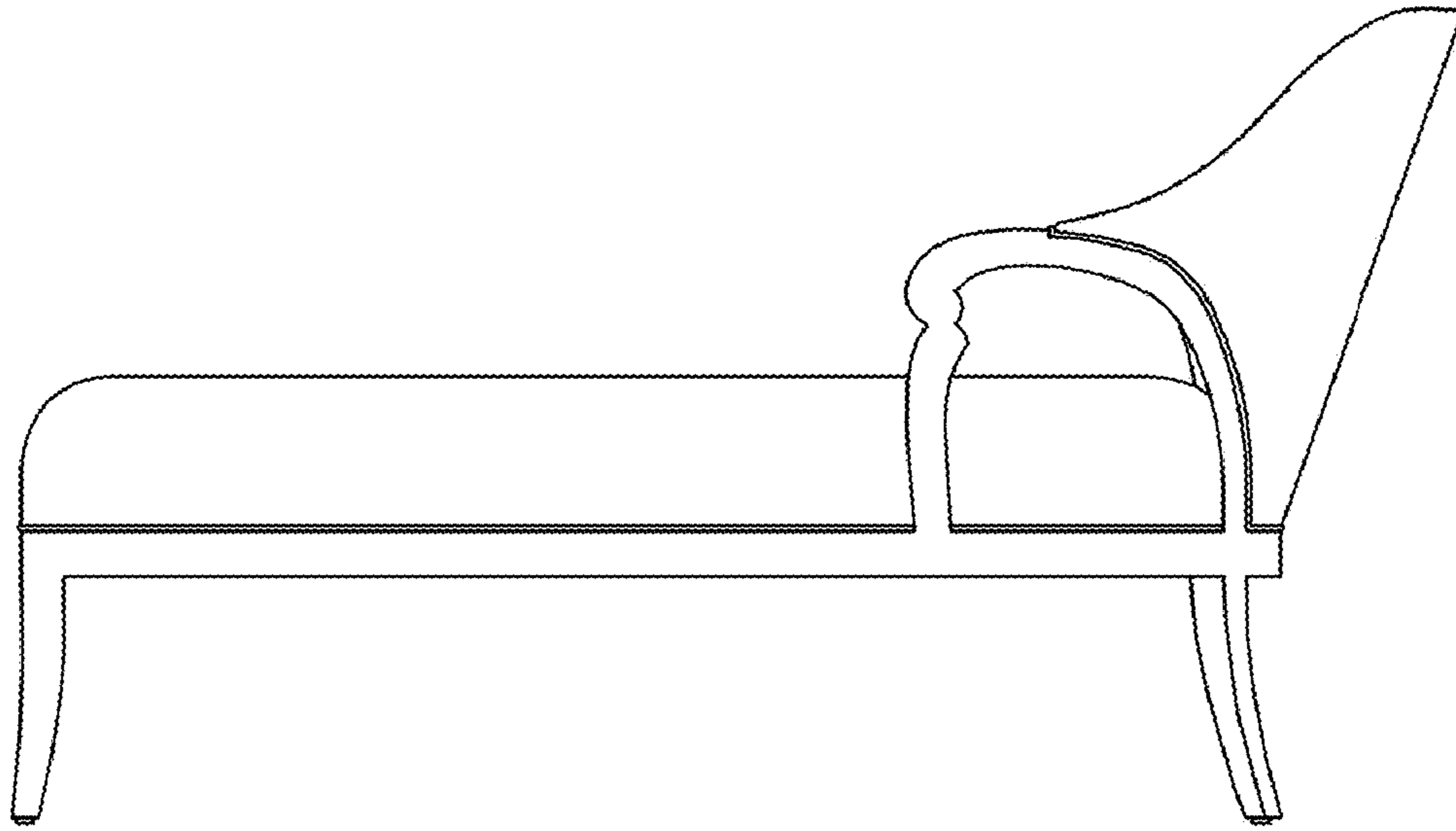

FIG. 5

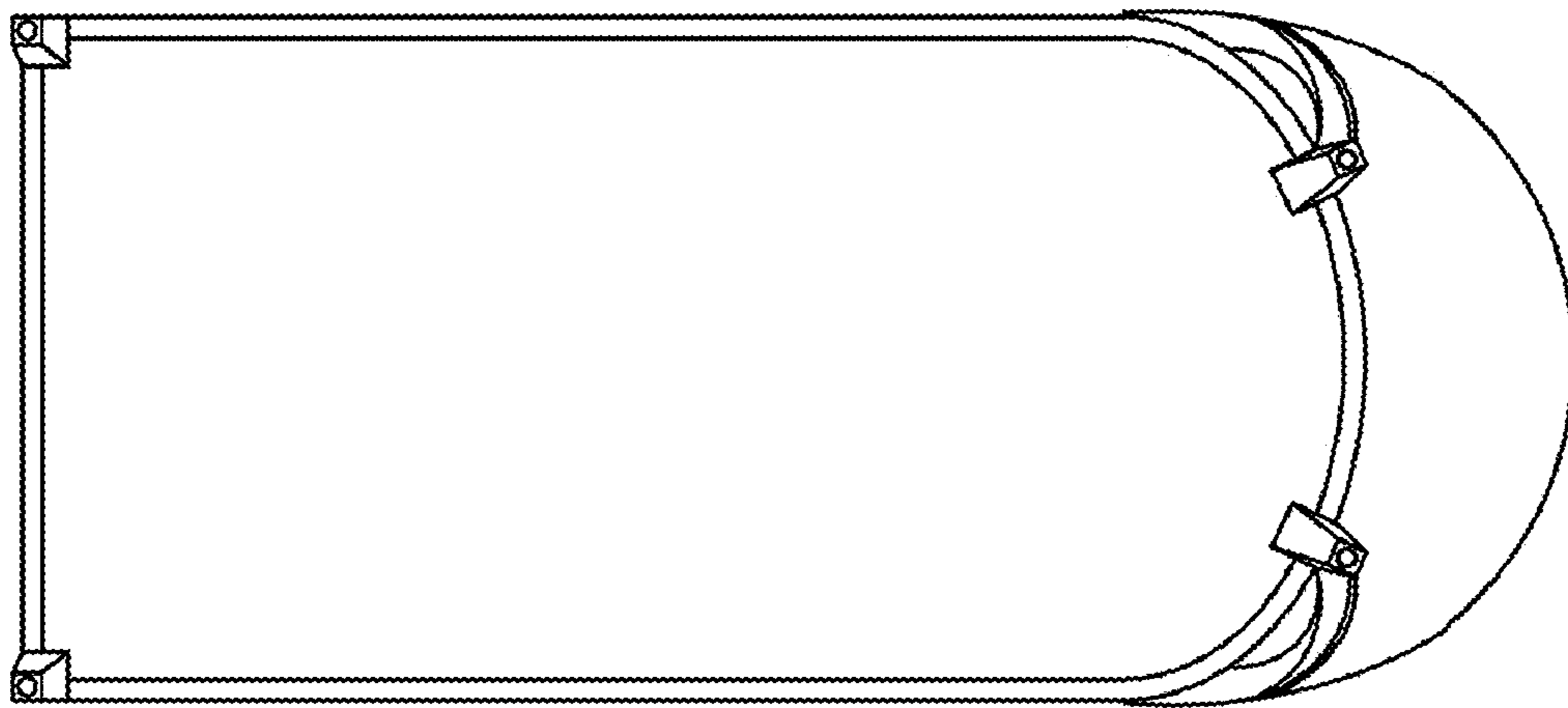

FIG. 6