



US00D644771S

(12) **United States Design Patent**
Okuda

(10) **Patent No.:** **US D644,771 S**

(45) **Date of Patent:** **** *Sep. 6, 2011**

(54) **TAILLIGHT FOR A BICYCLE**

(75) **Inventor:** **Yoji Okuda**, Osaka (JP)

(73) **Assignee:** **CatEye Co., Ltd.**, Osaka (JP)

(*) **Notice:** This patent is subject to a terminal disclaimer.

(**) **Term:** **14 Years**

(21) **Appl. No.:** **29/289,083**

(22) **Filed:** **Jul. 6, 2007**

(30) **Foreign Application Priority Data**

Jan. 10, 2007 (JP) 2007-000177

(51) **LOC (9) Cl.** **26-06**

(52) **U.S. Cl.** **D26/28**

(58) **Field of Classification Search** D26/28-36;
362/459-468, 475-478, 485-487

See application file for complete search history.

(56) **References Cited**

U.S. PATENT DOCUMENTS

D529,205	S	*	9/2006	Nagano	D26/28
D529,639	S	*	10/2006	Okuda	D26/28
D540,966	S	*	4/2007	Ueda et al.	D26/28

* cited by examiner

Primary Examiner — Marcus A. Jackson

(74) *Attorney, Agent, or Firm* — Olson & Cepuritis, Ltd.

(57) **CLAIM**

The ornamental design for a taillight for a bicycle, as shown.

DESCRIPTION

FIG. 1 is a front view of a taillight for a bicycle showing our my design;

FIG. 2 is a rear view thereof;

FIG. 3 is a top plan view thereof;

FIG. 4 is a right side view thereof;

FIG. 5 is a left side view thereof; and,

FIG. 6 is a perspective view thereof.

1 Claim, 2 Drawing Sheets

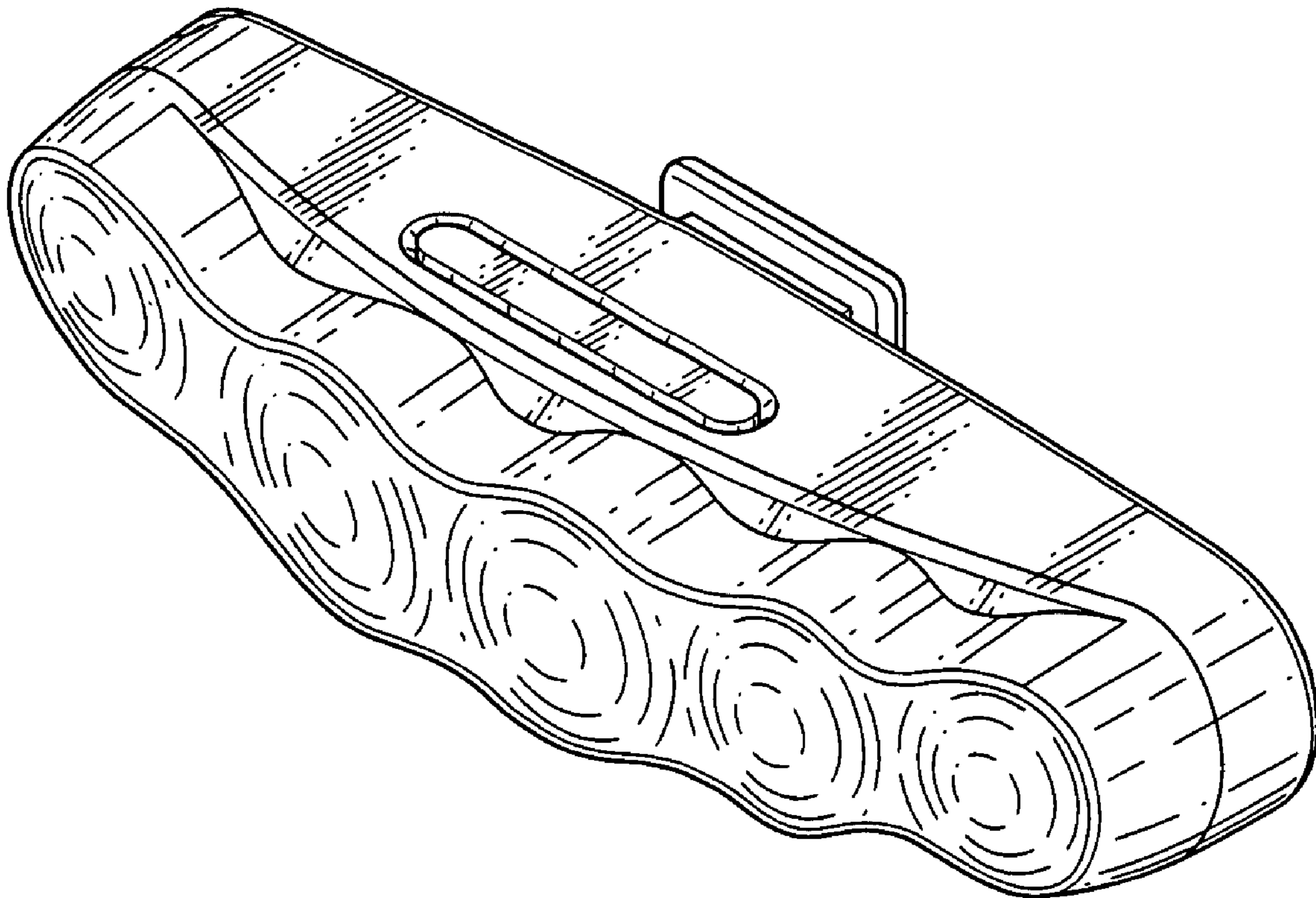

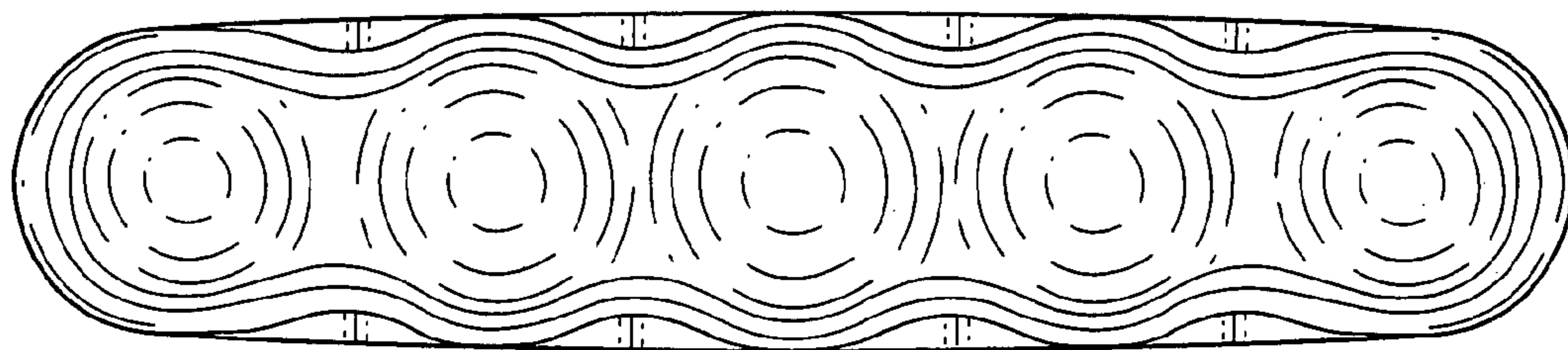

Fig. 1

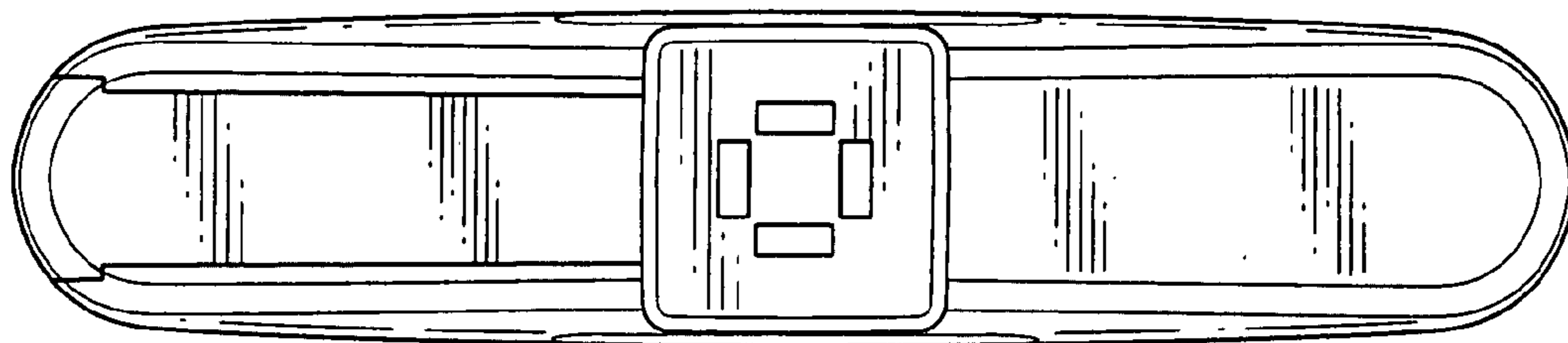

Fig. 2

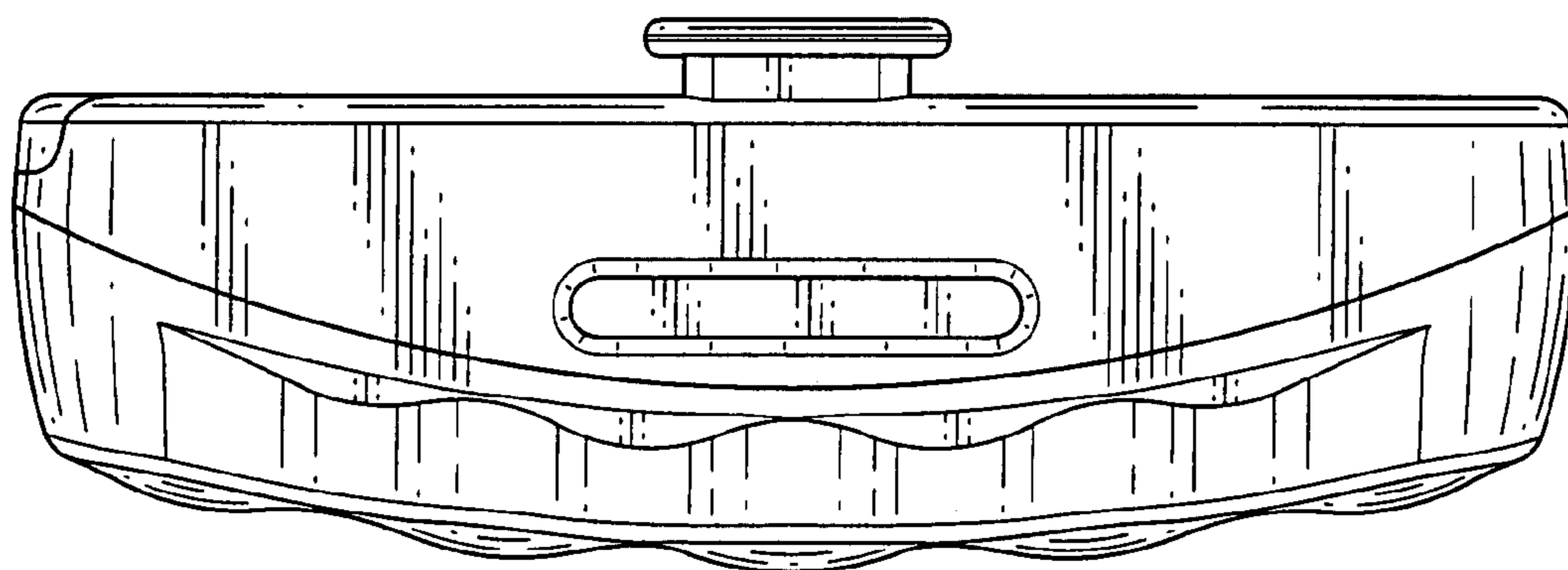

Fig. 3

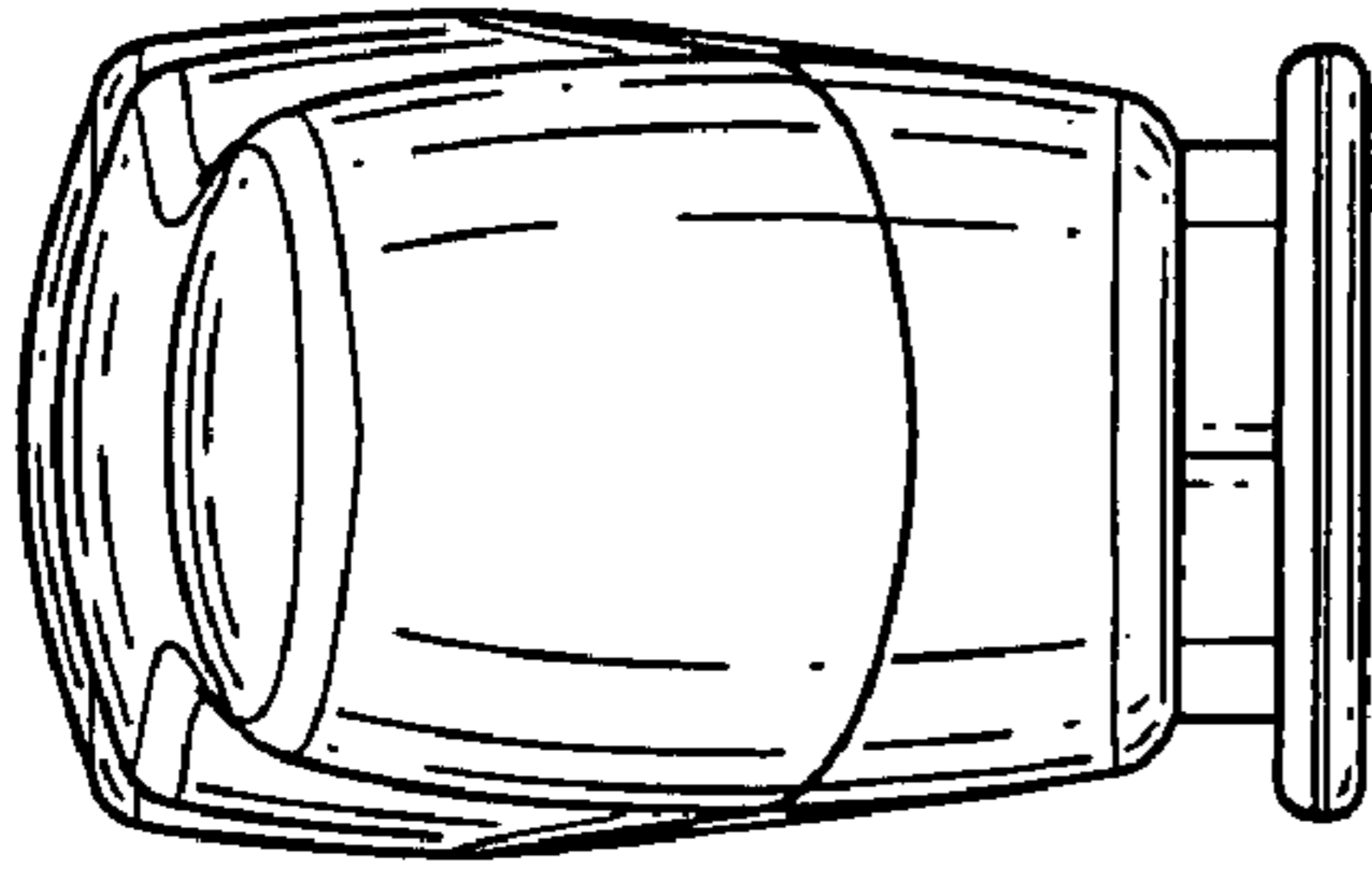

Fig. 4

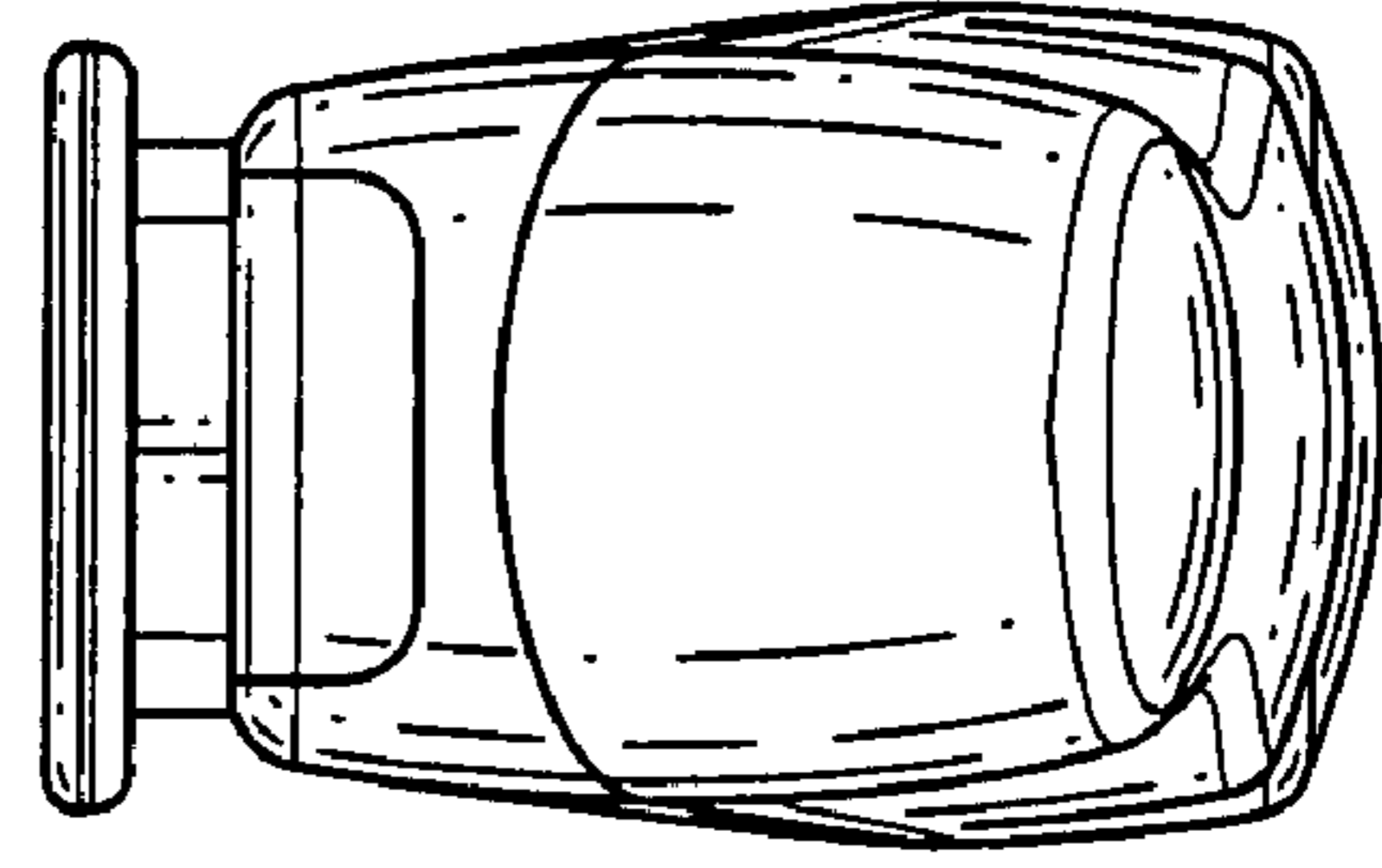

Fig. 5

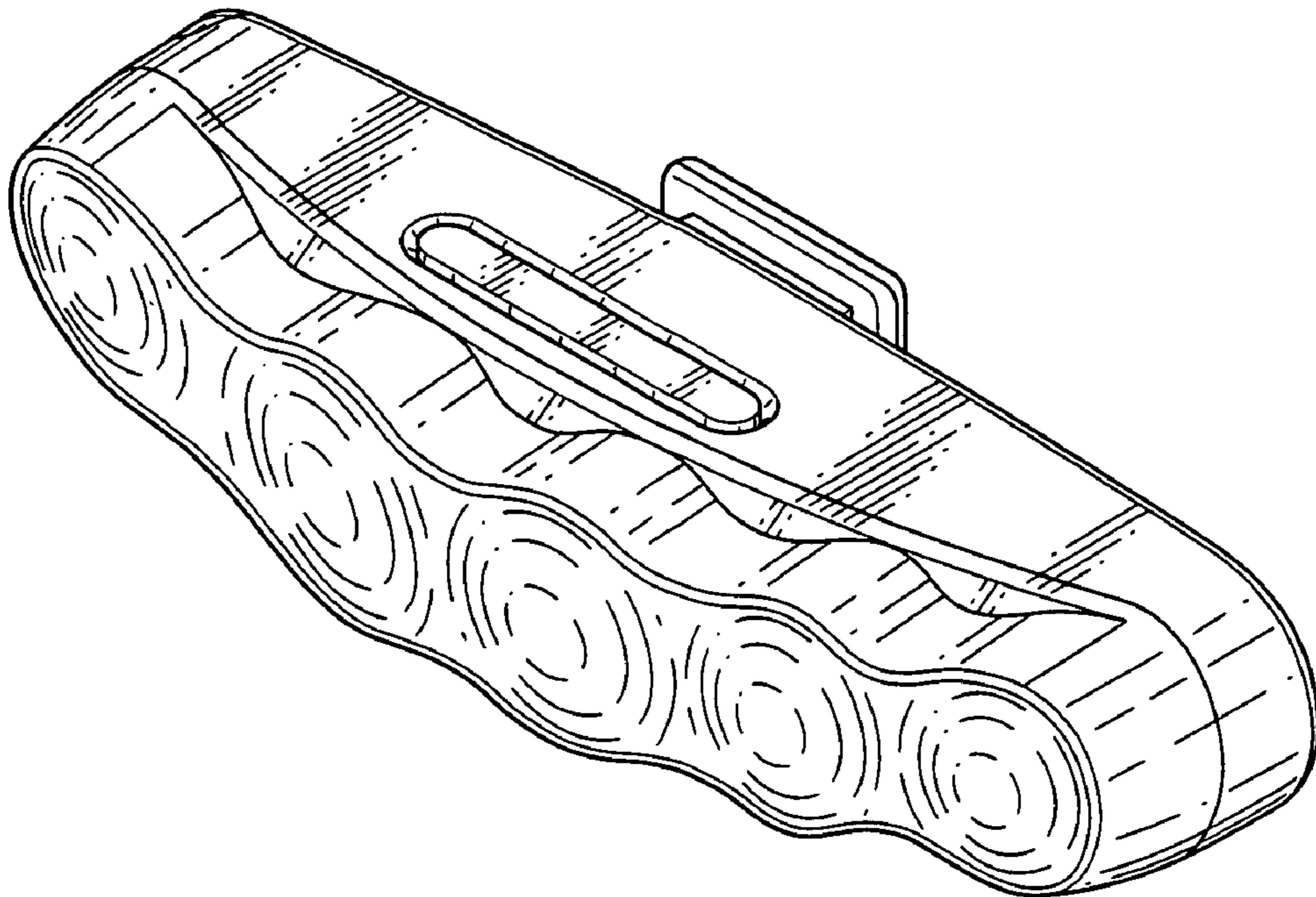

Fig. 6