



US00D644535S

(12) **United States Design Patent**
Gallagher

(10) **Patent No.:** **US D644,535 S**

(45) **Date of Patent:** **** Sep. 6, 2011**

(54) **RE-CLOSABLE BAG WITH INTEGRATED FINGER SLEEVES**

(75) Inventor: **Robert Gallagher**, Grapevine, TX (US)

(73) Assignee: **Rockaway Tucker International, Inc.**, Grapevine, TX (US)

(**) Term: **14 Years**

(21) Appl. No.: **29/376,649**

(22) Filed: **Oct. 8, 2010**

(51) **LOC (9) Cl.** **09-05**

(52) **U.S. Cl.** **D9/709**

(58) **Field of Classification Search** D9/702-714,
D9/499, 430-433; 222/92, 107, 206, 215;
229/87.06, 87.08, 87.14; 206/260, 811, 484;
D3/303, 203.1, 203.2; D24/118, 121; 383/61.1,
383/119, 108, 103, 127; 220/666; 211/85.15;
428/35.2; D29/113, 114, 117.1; 2/16, 158,
2/159, 161.7, 163; 15/227

See application file for complete search history.

(56) **References Cited**

U.S. PATENT DOCUMENTS

D445,963	S	*	7/2001	DeRosa	D29/113
D533,314	S	*	12/2006	Schiazza	D29/113
D555,009	S	*	11/2007	Lin	D9/707
D557,148	S	*	12/2007	Kapinos, Sr.	D9/707
D563,241	S	*	3/2008	Nimey	D9/705
D602,377	S	*	10/2009	Lin	D9/709
D613,615	S	*	4/2010	Hedstrom	D9/702
D617,654	S	*	6/2010	Tawinsook	D9/702
D623,075	S	*	9/2010	Blythe	D9/709
D623,536	S	*	9/2010	Bohmke	D9/707
D633,809	S	*	3/2011	Bradley	D9/703
D634,645	S	*	3/2011	LaFauci et al.	D9/707
2002/0178482	A1	*	12/2002	Samuelsson et al.	2/16

* cited by examiner

FOREIGN PATENT DOCUMENTS

WO WO 91/03954 * 4/1991

Primary Examiner — Caron D Veynar

Assistant Examiner — Abraham Bahta

(74) *Attorney, Agent, or Firm* — Patent Capital Group

(57) **CLAIM**

The ornamental design for a re-closable bag with integrated finger sleeves, as shown and described.

DESCRIPTION

FIG. 1 is a perspective view of a first embodiment of a bag with integrated finger sleeves showing the top and front sides thereof, the bag illustrated in a first condition;

FIG. 2 is a perspective view of the bag of FIG. 1, showing the bottom and front sides thereof, the bag illustrated in a first condition;

FIG. 3 is a front plan view of the bag of FIG. 1, the bag illustrated in a first condition;

FIG. 4 is a rear plan view of the bag of FIG. 1, the bag illustrated in a first condition;

FIG. 5 is a perspective view of the bag of FIG. 1, showing the top, left, and front sides thereof, the bag illustrated in a second condition;

FIG. 6 is a perspective view of the bag of FIG. 1, showing the top, right, and rear sides thereof, the bag illustrated in a second condition;

FIG. 7 is a right side view of the bag of FIG. 1, the bag illustrated in a second condition;

FIG. 8 is a left side view of the bag of FIG. 1, the bag illustrated in a second condition;

FIG. 9 is a bottom side view of the bag of FIG. 1, the bag illustrated in a second condition;

FIG. 10 is a top side view of the bag of FIG. 1, the bag illustrated in a second condition;

FIG. 11 is a perspective view of the bag of FIG. 1, showing the top, left, and front sides thereof, the bag illustrated in a third condition;

FIG. 12 is a perspective view of the bag of FIG. 1, showing the bottom, right, and rear sides thereof, the bag illustrated in a third condition;

FIG. 13 is a perspective view of the bag of FIG. 1, showing the rear and left sides thereof, the bag illustrated in a fourth condition;

FIG. 14 is a perspective view of the bag of FIG. 1, showing the front and left sides thereof, the bag illustrated in a fourth condition;

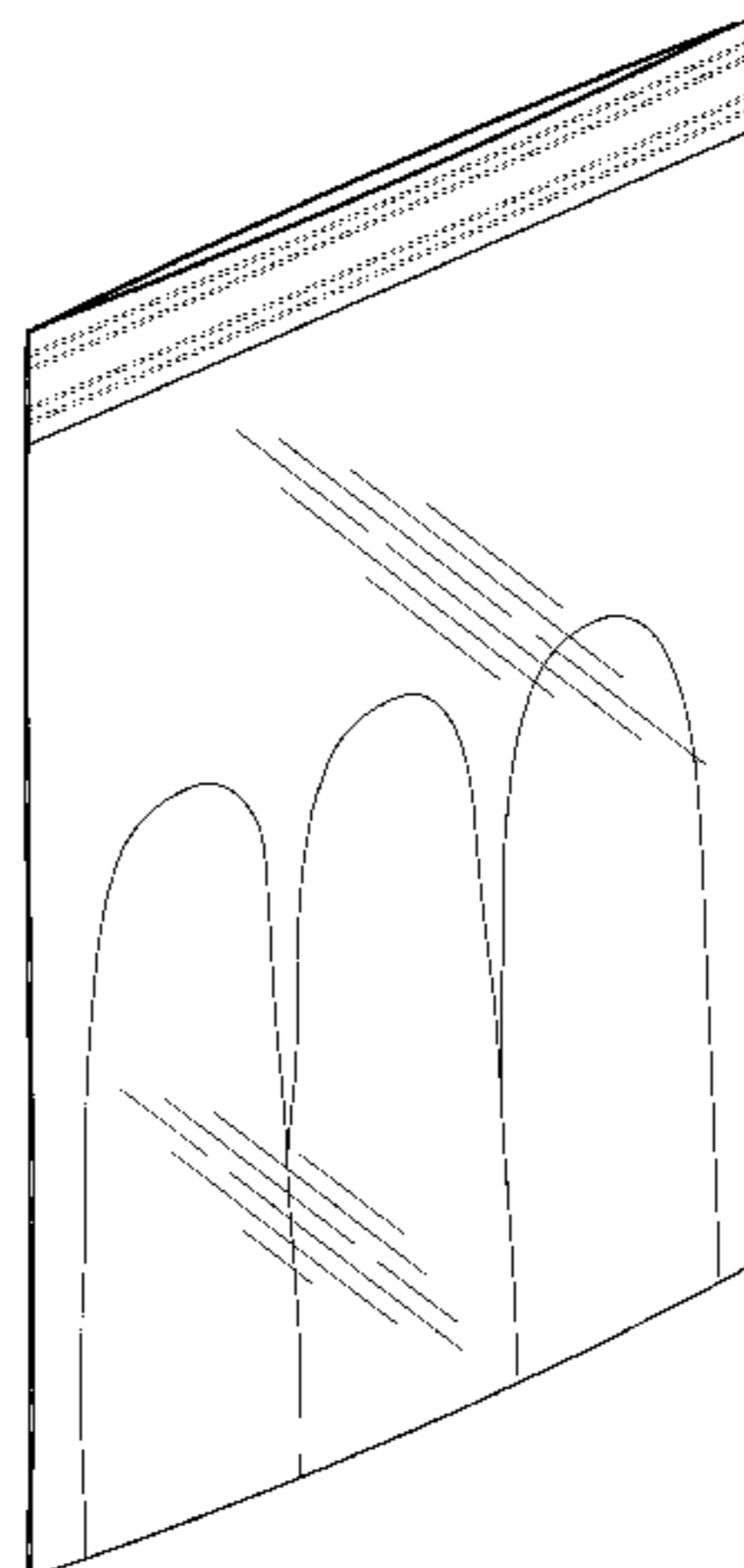
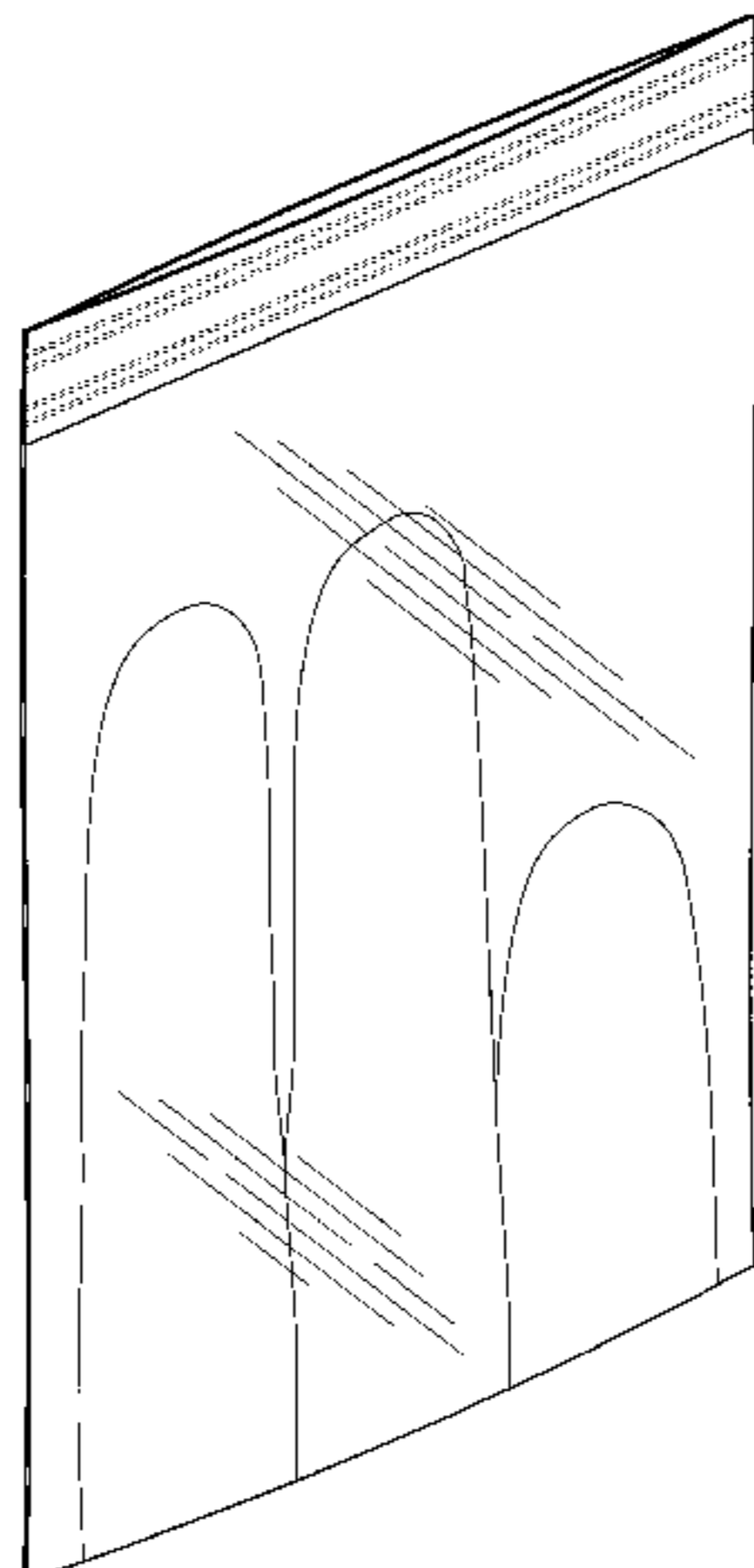

FIG. 15 is a front plan view of the bag of FIG. 1, the bag illustrated in a fourth condition;

FIG. 16 is a rear plan view of the bag of FIG. 1, the bag illustrated in a fourth condition;

FIG. 17 is a right side view of the bag of FIG. 1, the bag illustrated in a fourth condition;

FIG. 18 is a left side view of the bag of FIG. 1, the bag illustrated in a fourth condition;

FIG. 19 is a perspective view of a second embodiment of a bag with integrated finger sleeves showing the top and front sides thereof, the bag illustrated in a first condition;

FIG. 20 is a perspective view of the bag of FIG. 19, showing the bottom and front sides thereof, the bag illustrated in a first condition;

FIG. 21 is a front plan view of the bag of FIG. 19, the bag illustrated in a first condition;

FIG. 22 is a rear plan view of the bag of FIG. 19, the bag illustrated in a first condition;

FIG. 23 is a perspective view of the bag of FIG. 19, showing the top, left, and front sides thereof, the bag illustrated in a second condition;

FIG. 24 is a perspective view of the bag of FIG. 19, showing the top, right, and rear sides thereof, the bag illustrated in a second condition;

FIG. 25 is a right side view of the bag of FIG. 19, the bag illustrated in a second condition;

FIG. 26 is a left side view of the bag of FIG. 19, the bag illustrated in a second condition;

FIG. 27 is a bottom side view of the bag of FIG. 19, the bag illustrated in a second condition;

FIG. 28 is a top side view of the bag of FIG. 19, the bag illustrated in a second condition;

FIG. 29 is a perspective view of the bag of FIG. 19, showing the top, left, and front sides thereof, the bag illustrated in a third condition; and,

FIG. 30 is a perspective view of the bag of FIG. 19, showing the bottom, right, and rear sides thereof, the bag illustrated in a third condition;

The broken lines are for environmental purposes only and form no part of the claimed design.

1 Claim, 25 Drawing Sheets

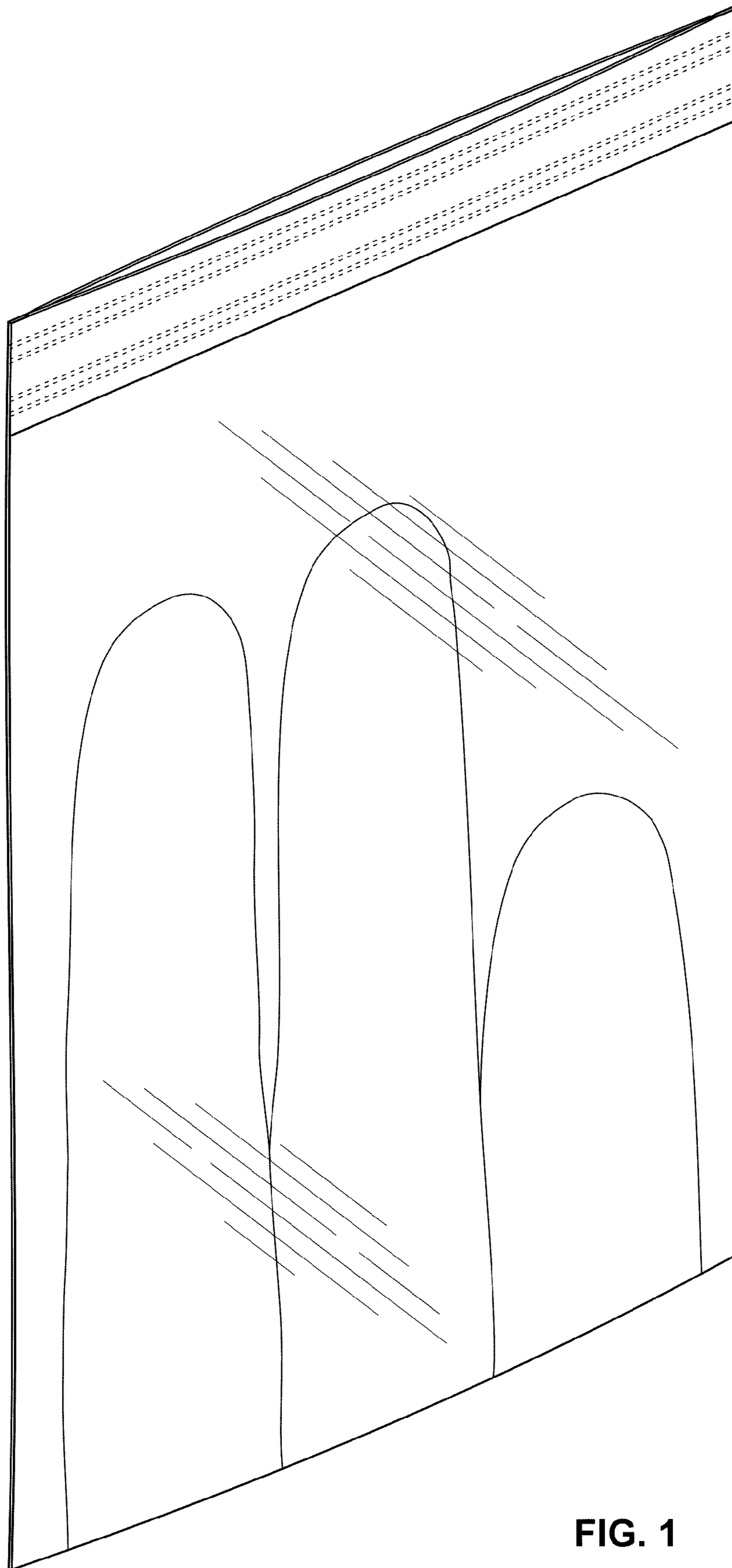

FIG. 1

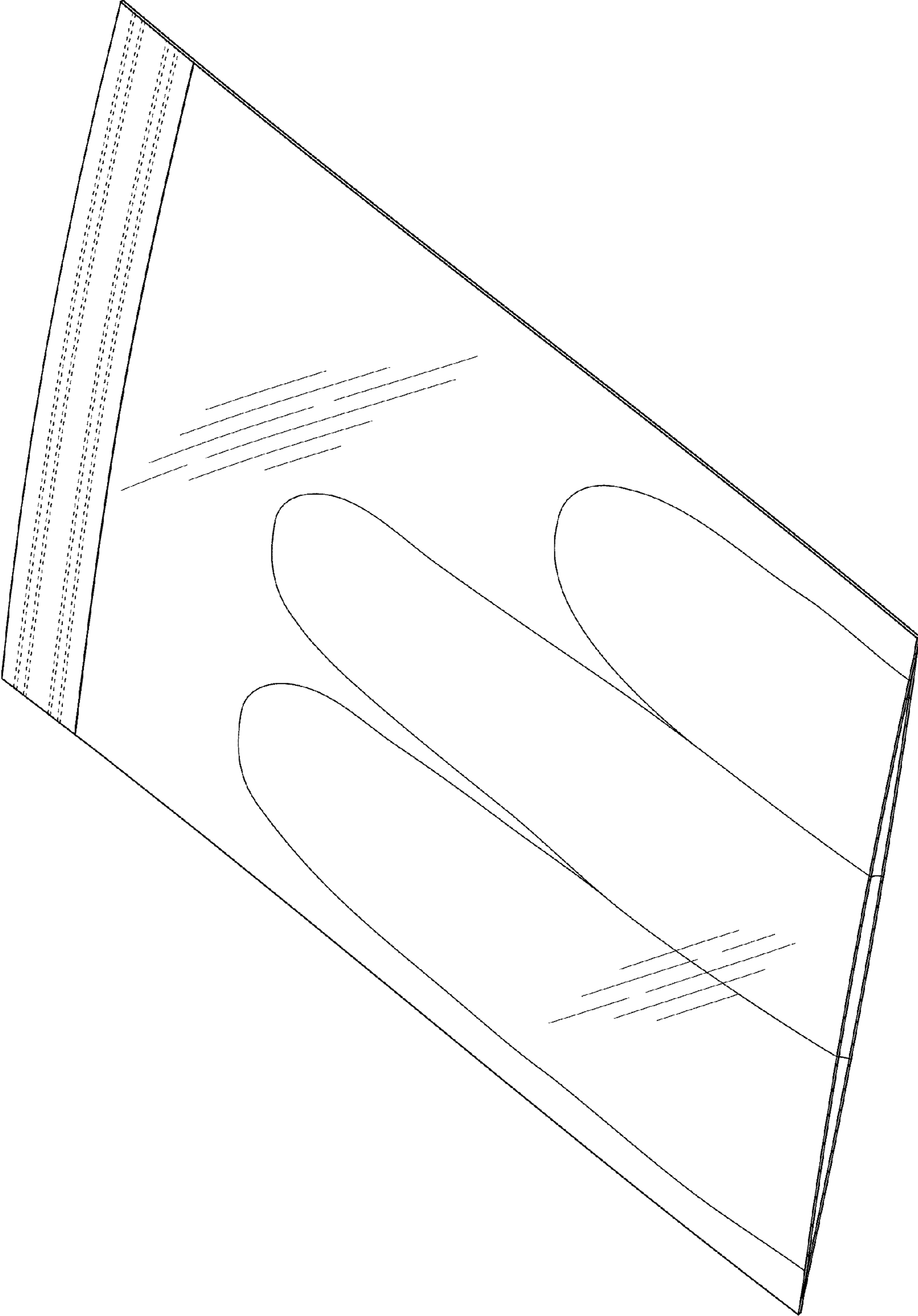

FIG. 2

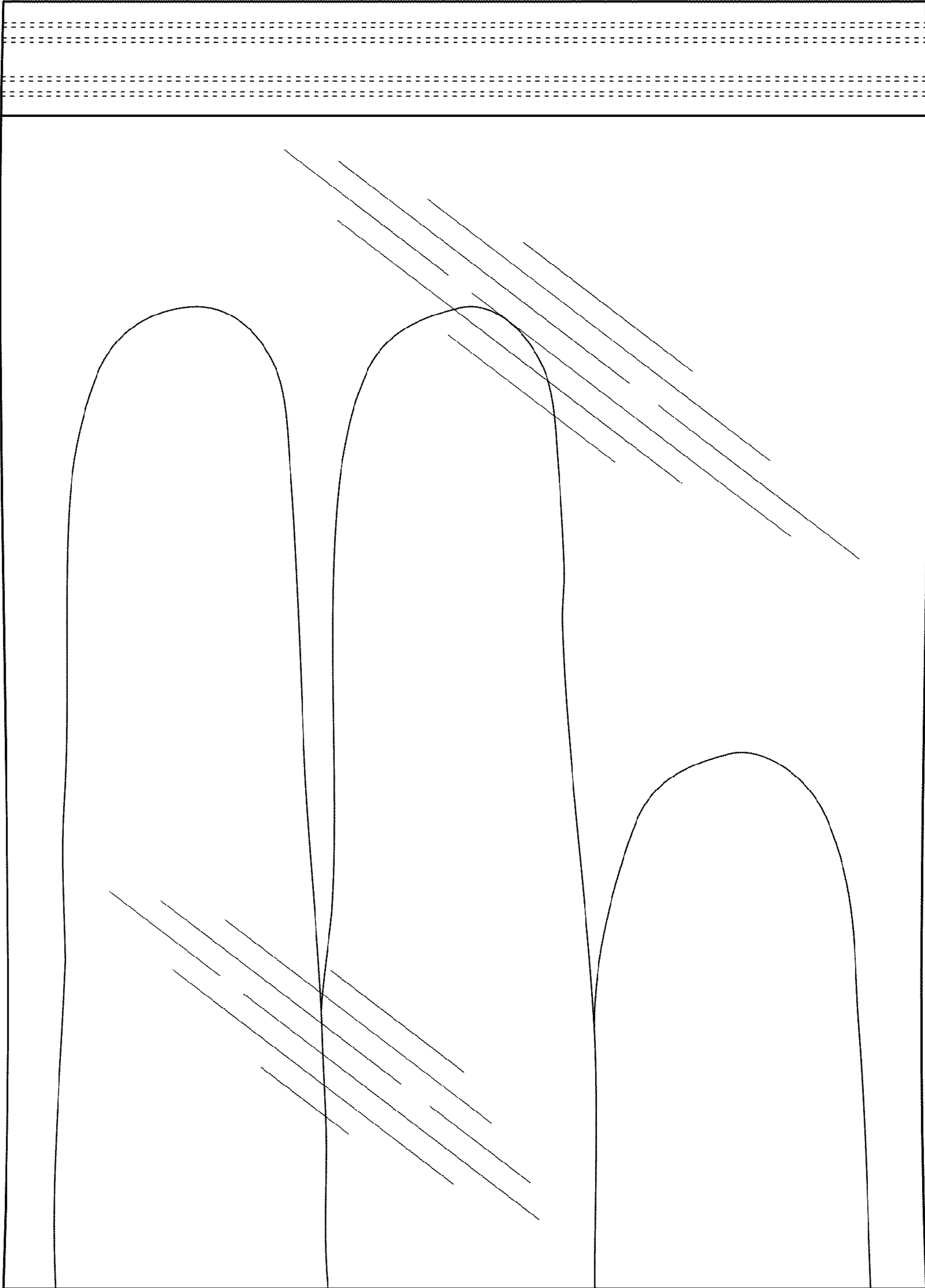

FIG. 3

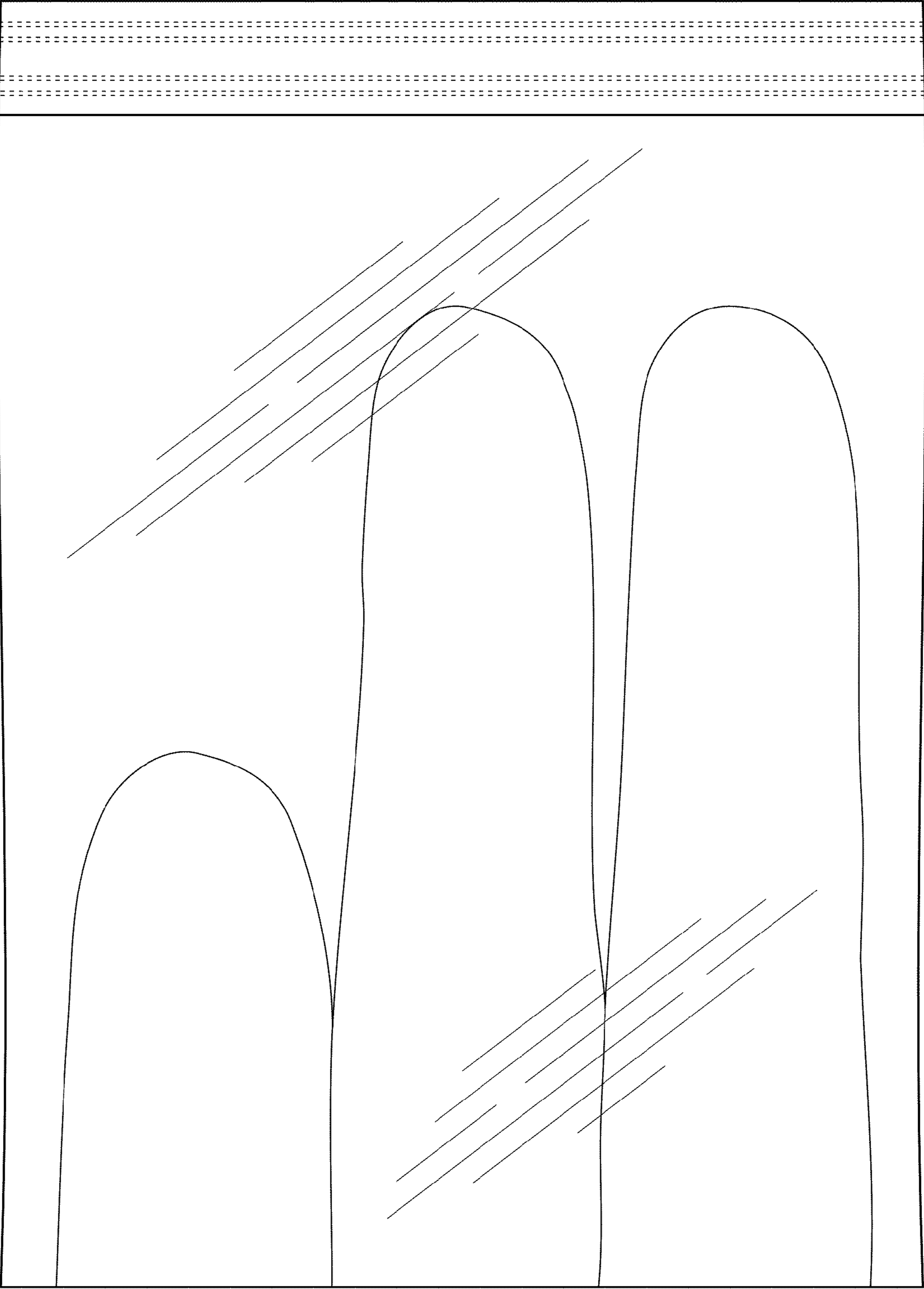

FIG. 4

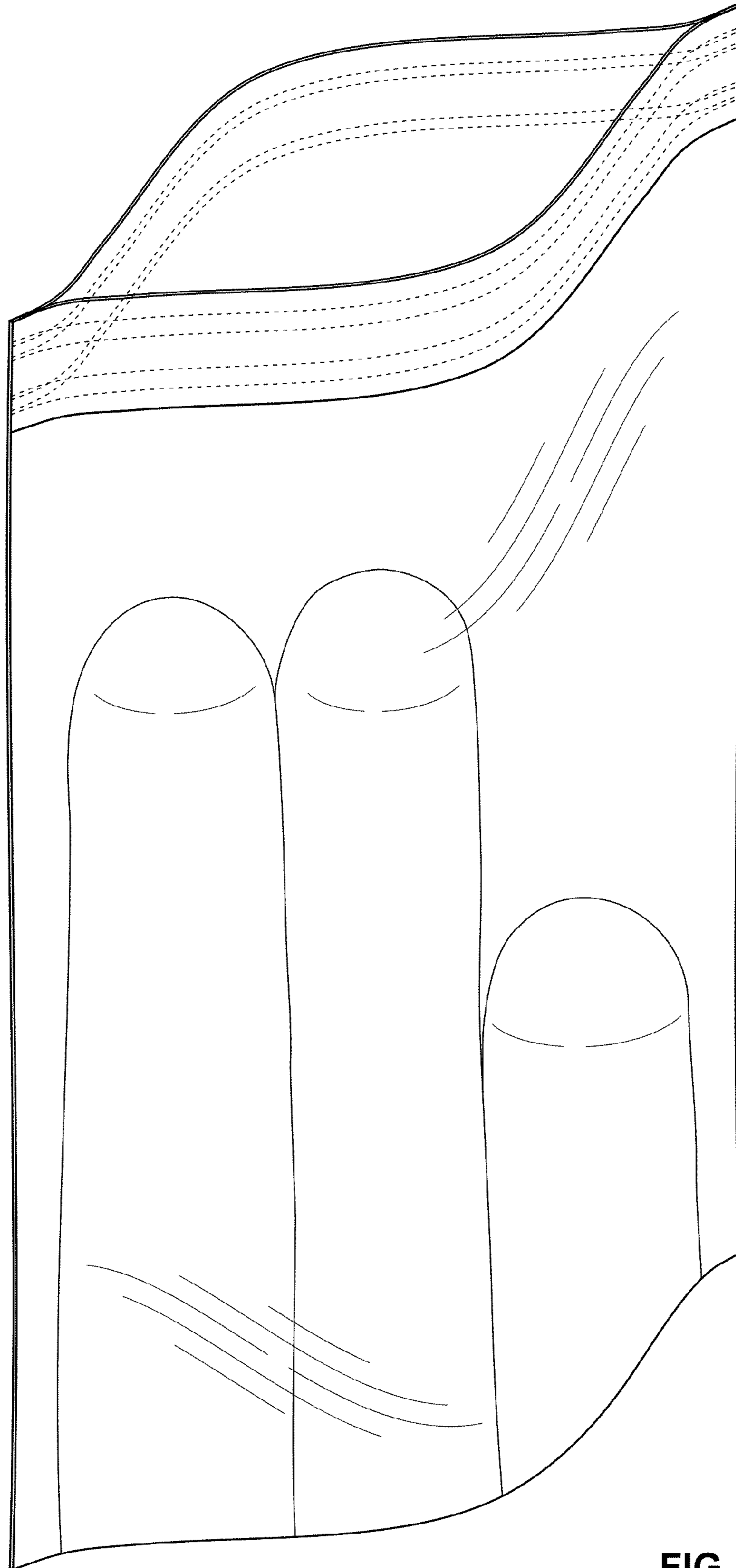

FIG. 5

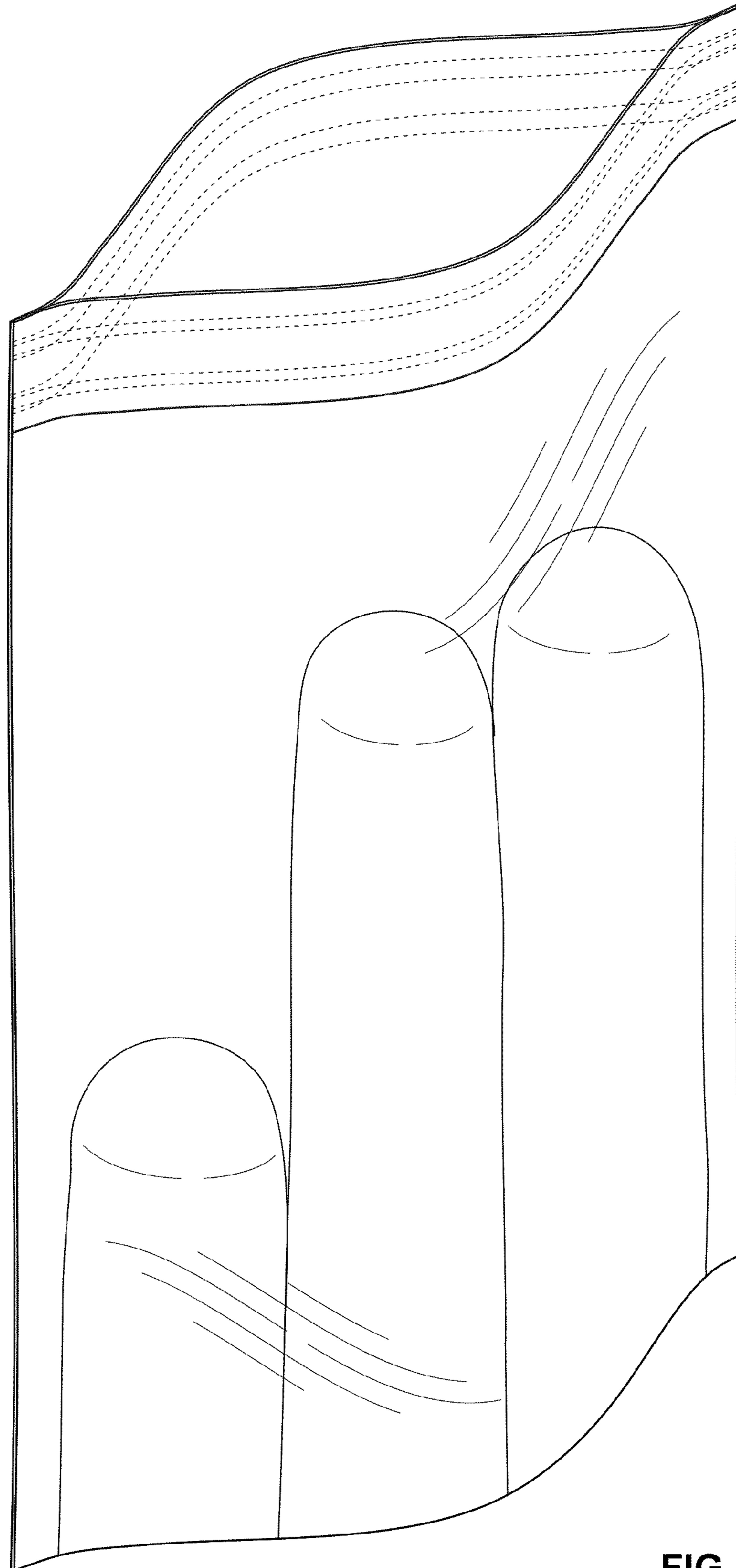

FIG. 6

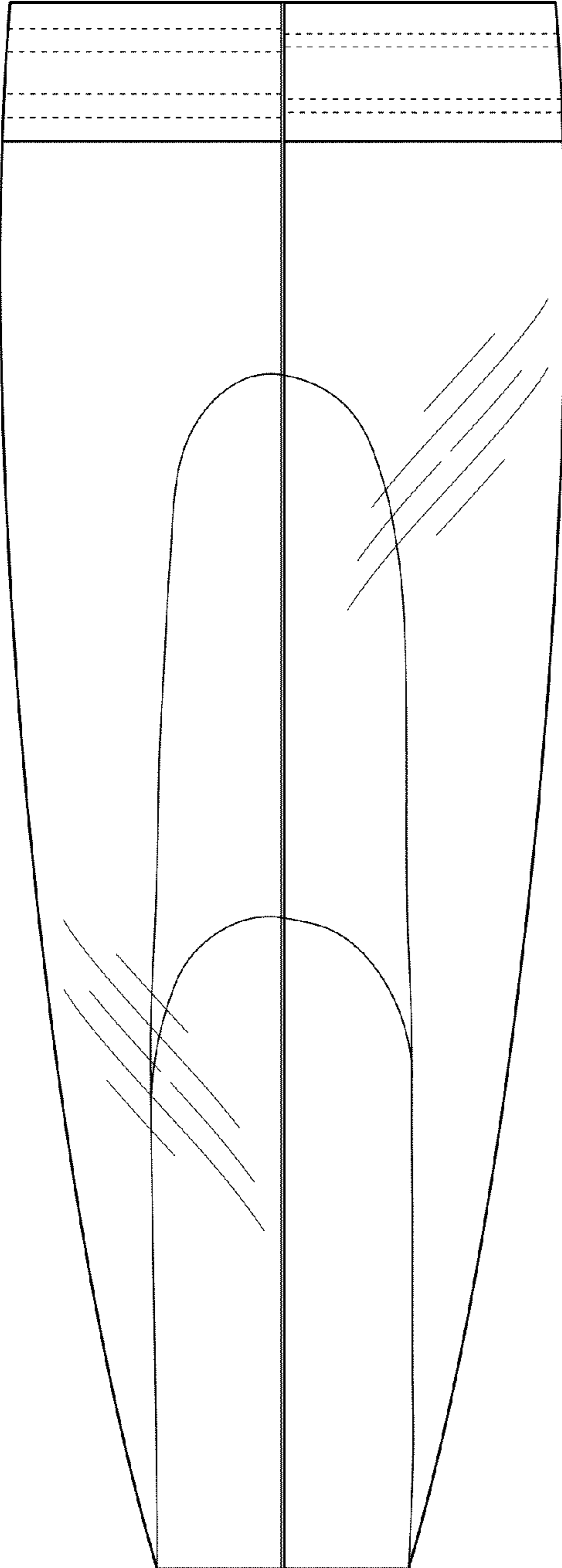

FIG. 7

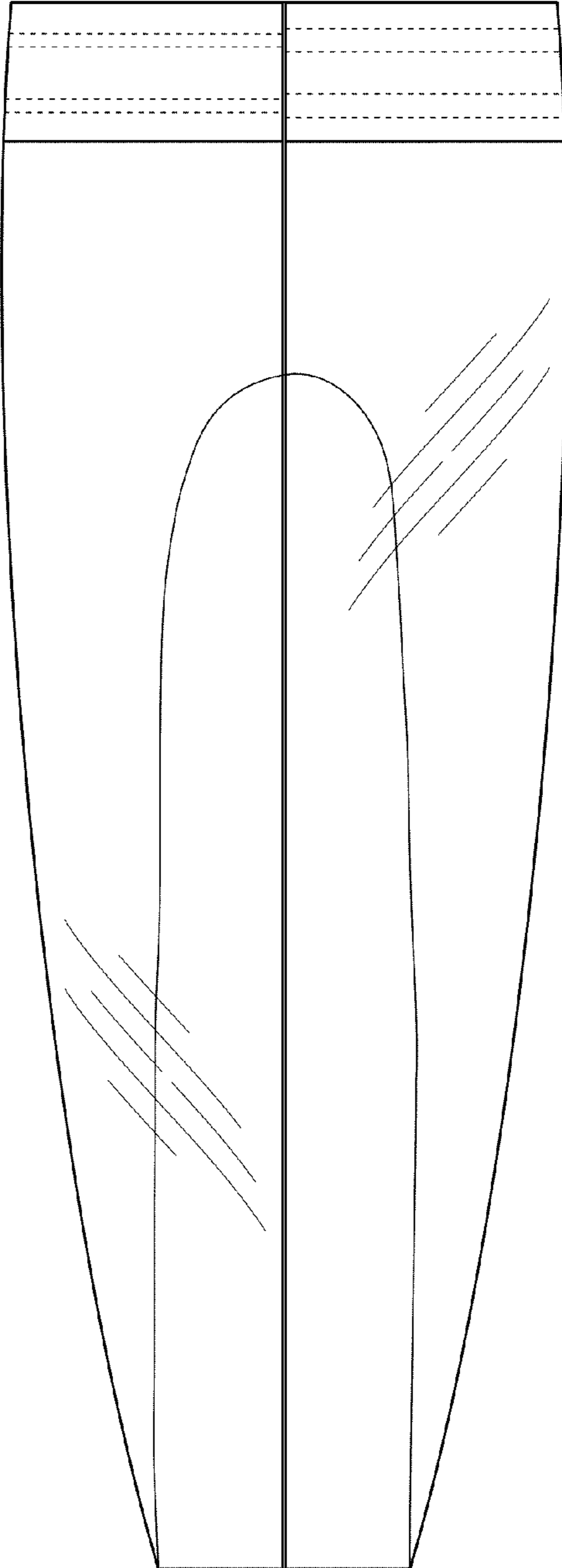

FIG. 8

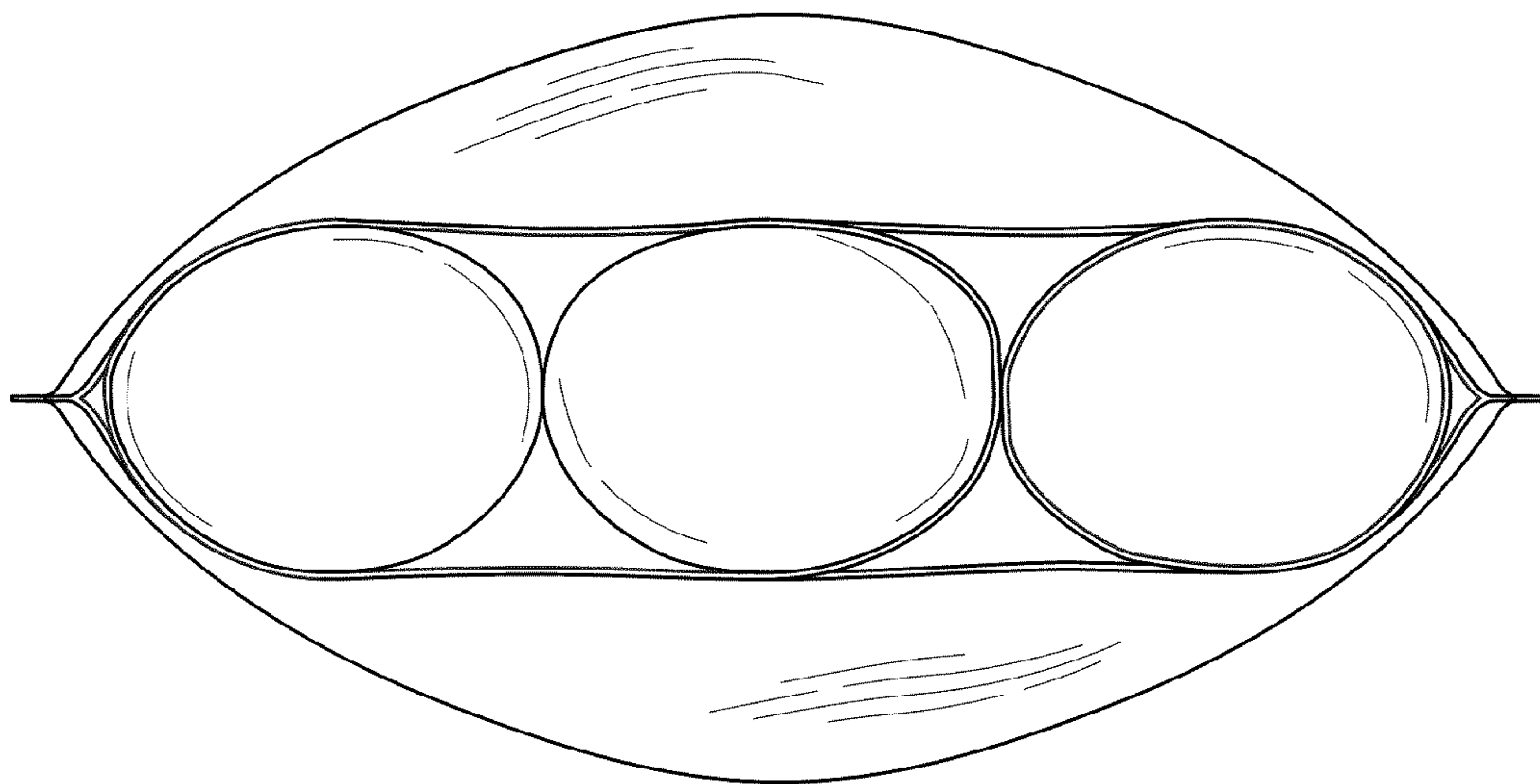

FIG. 9

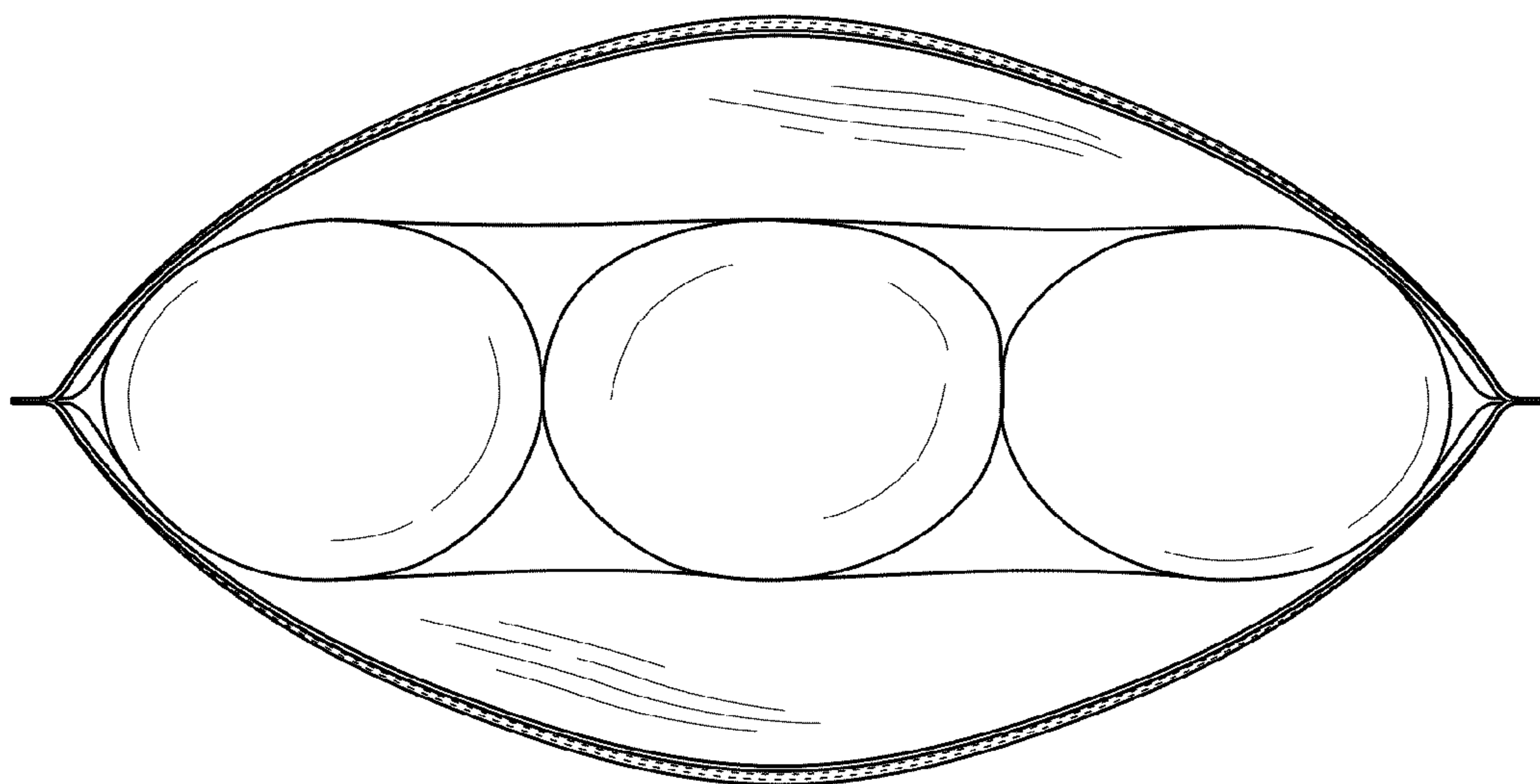

FIG. 10

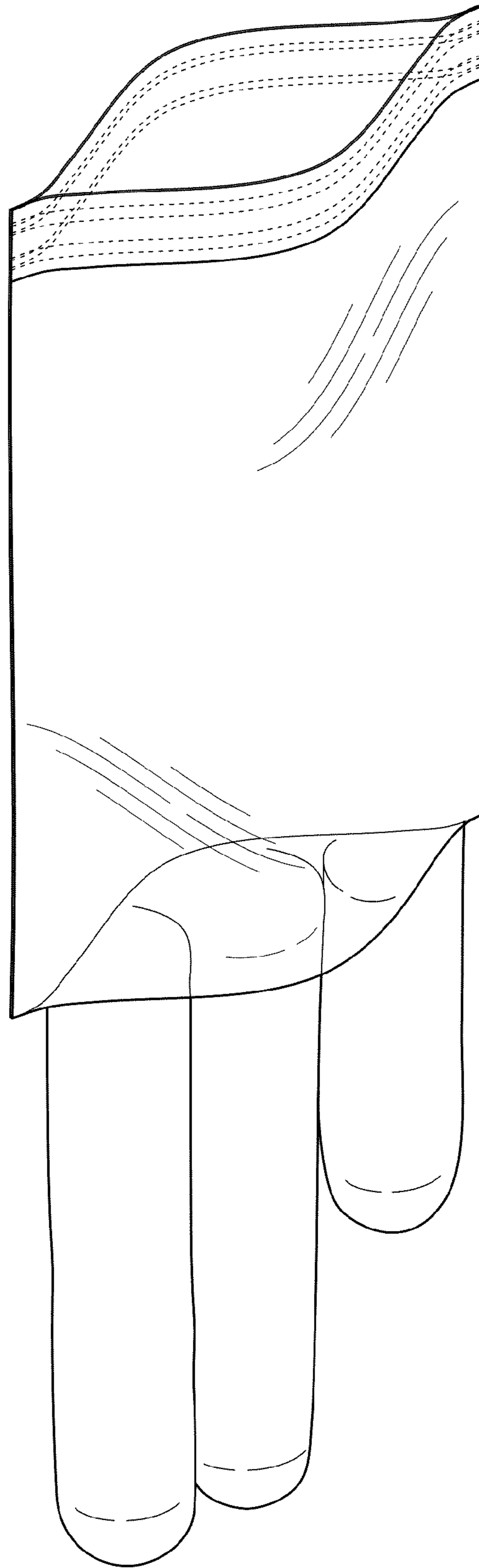

FIG. 11

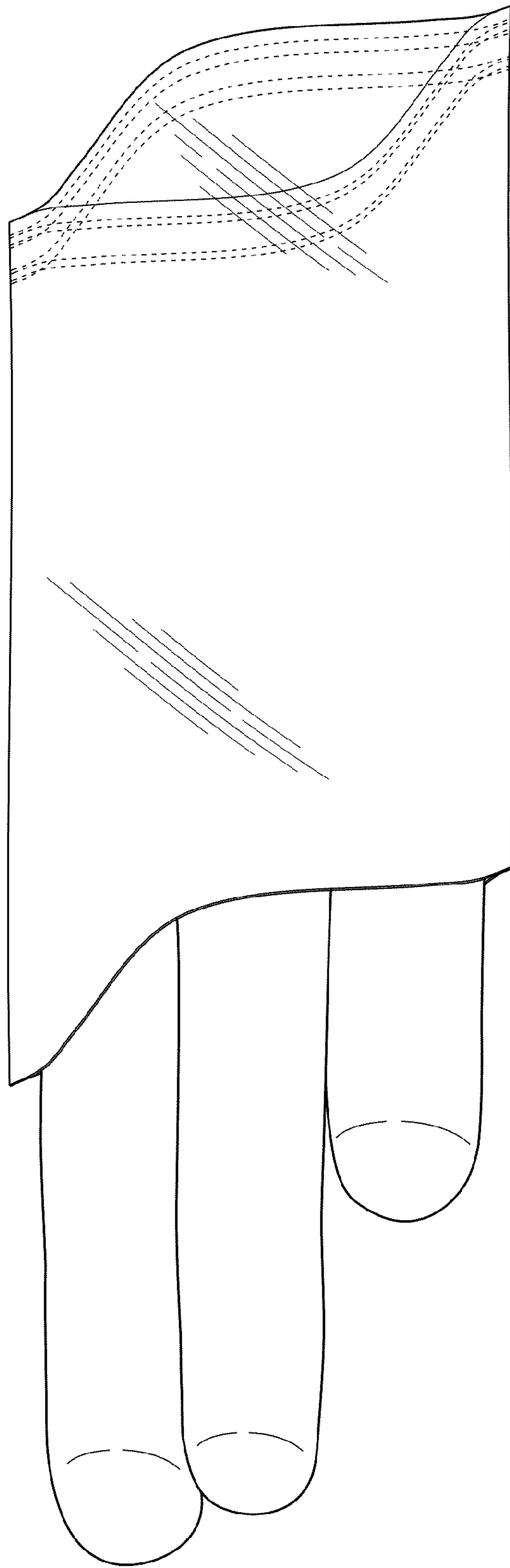

FIG. 12

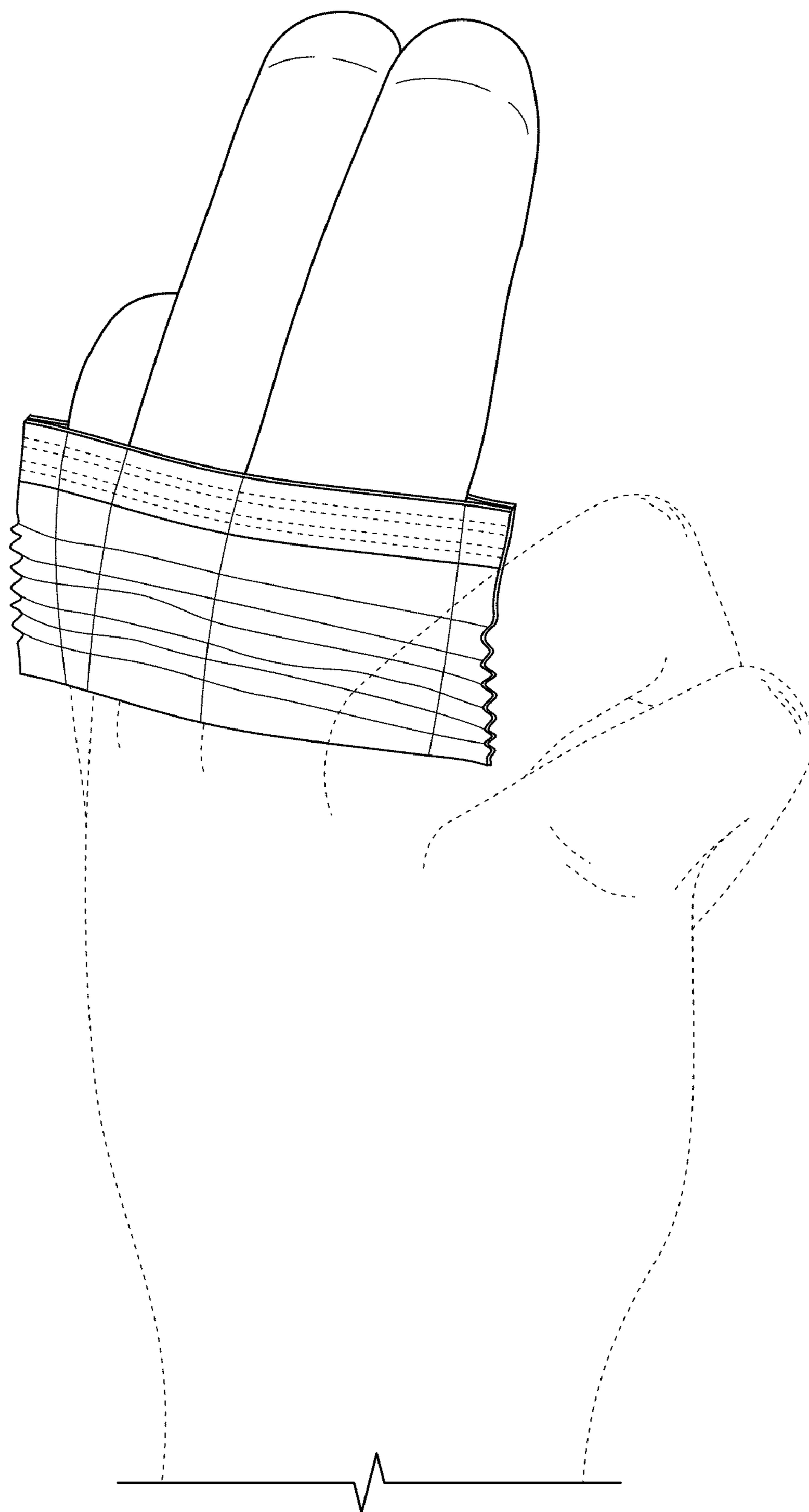

FIG. 13

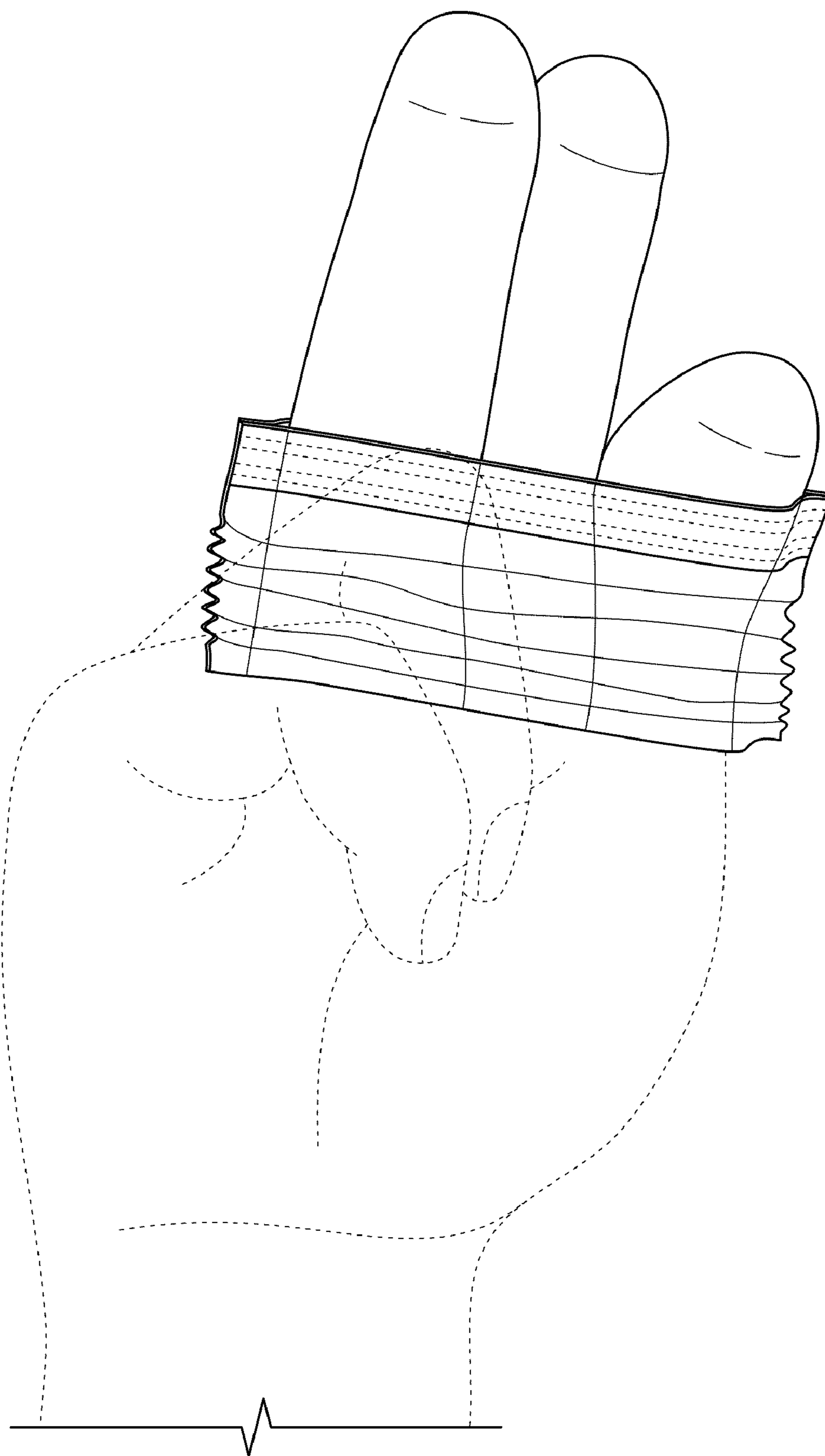

FIG. 14

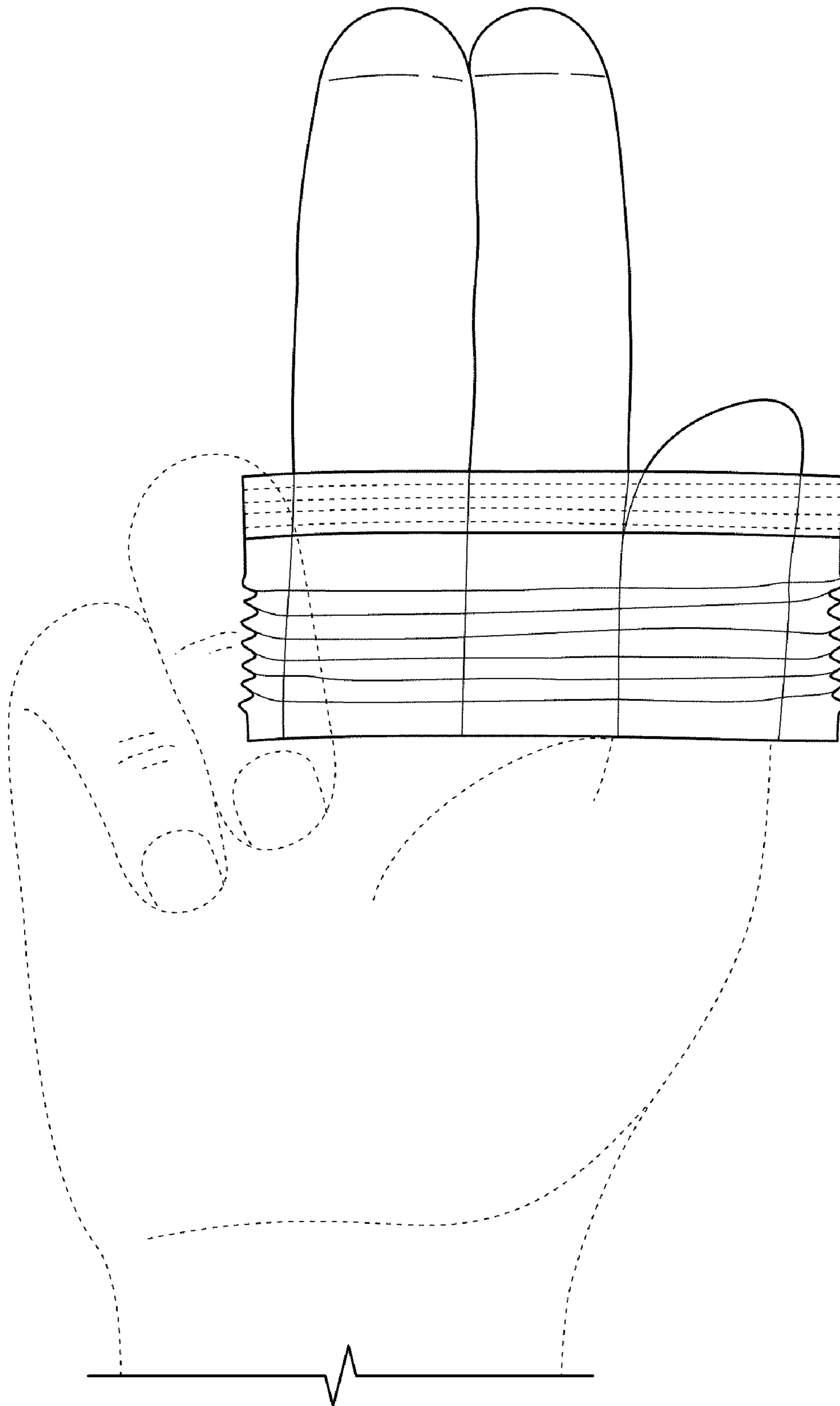

FIG. 15

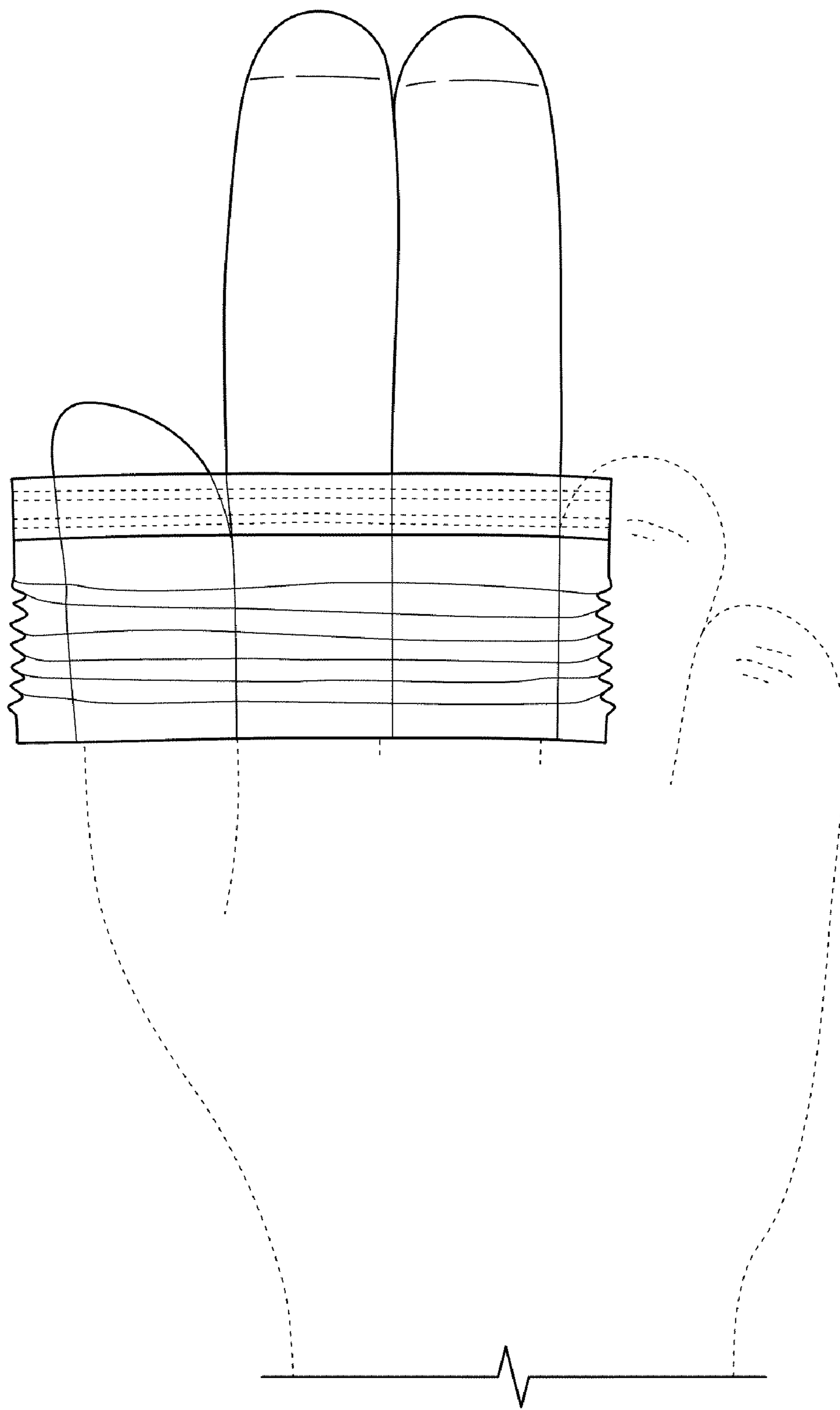

FIG. 16

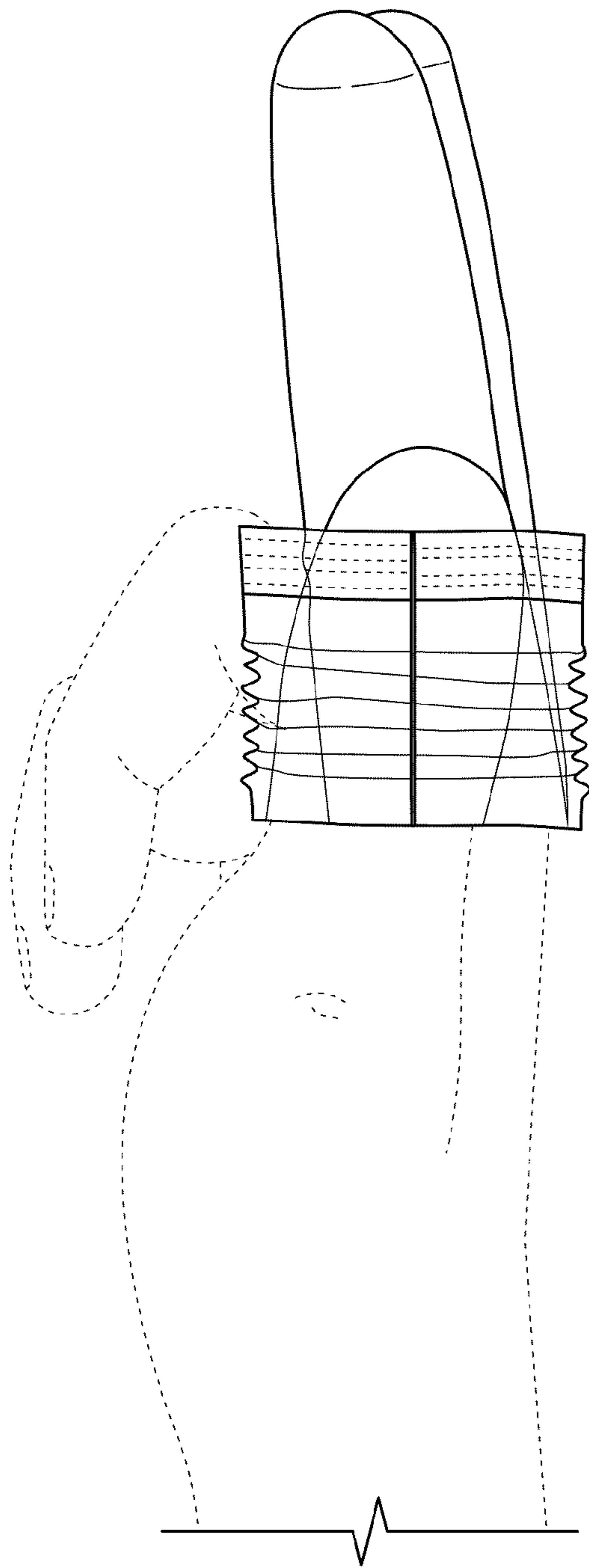

FIG. 17

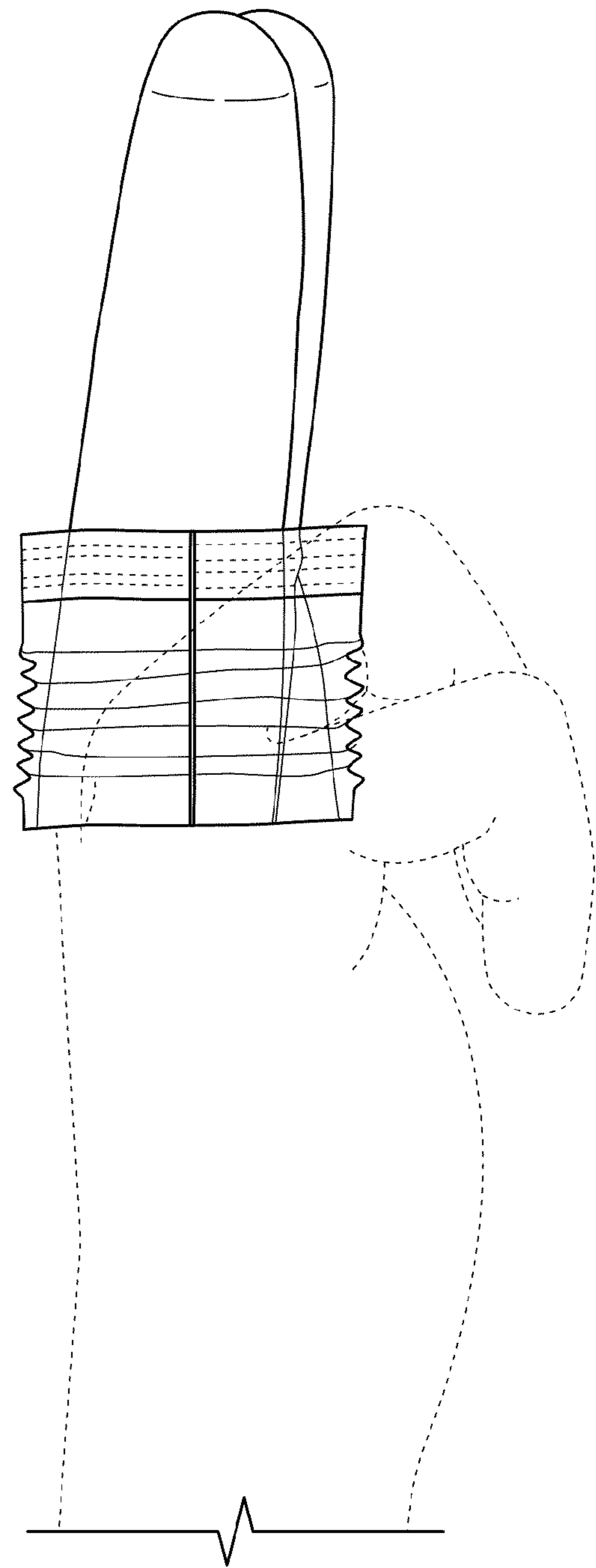

FIG. 18

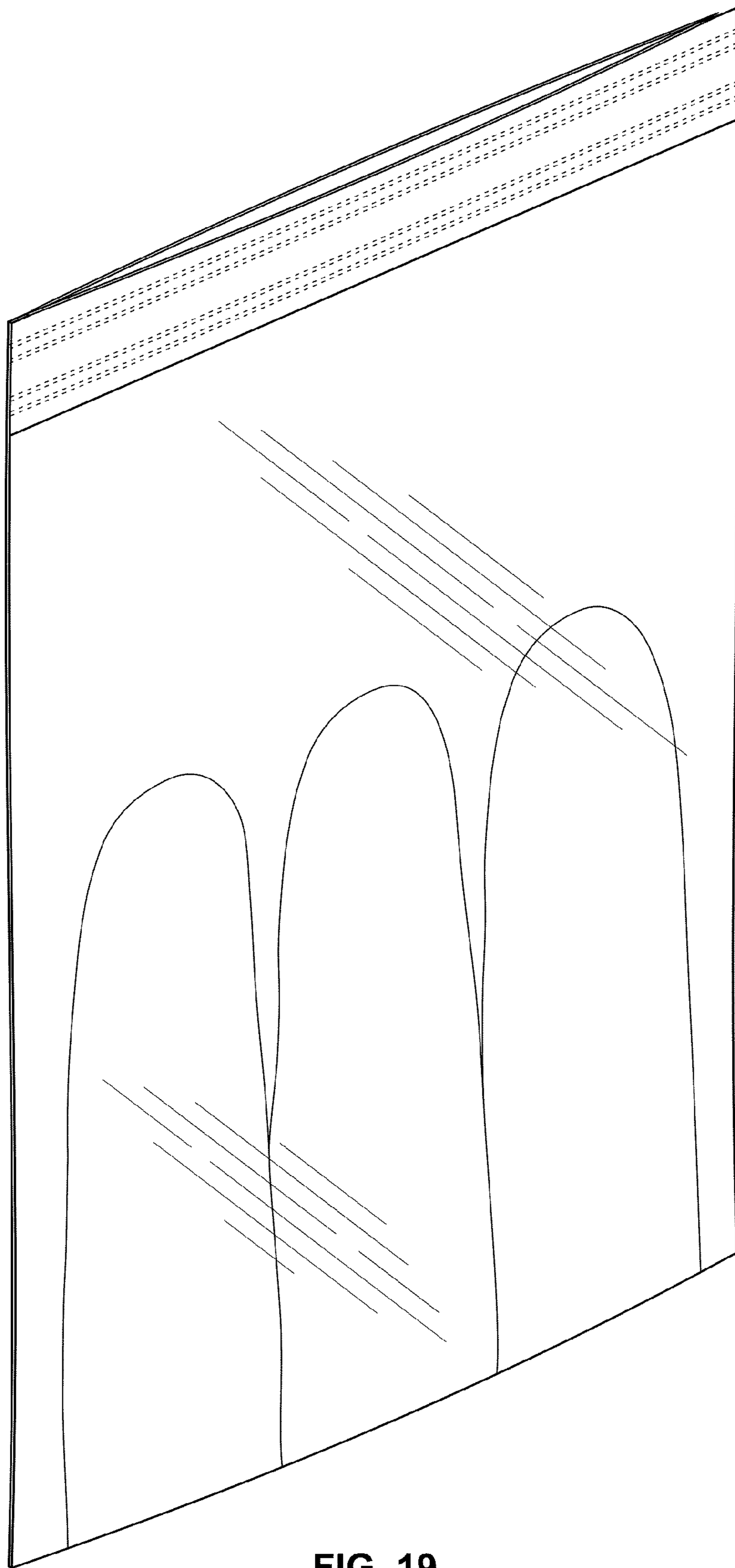

FIG. 19

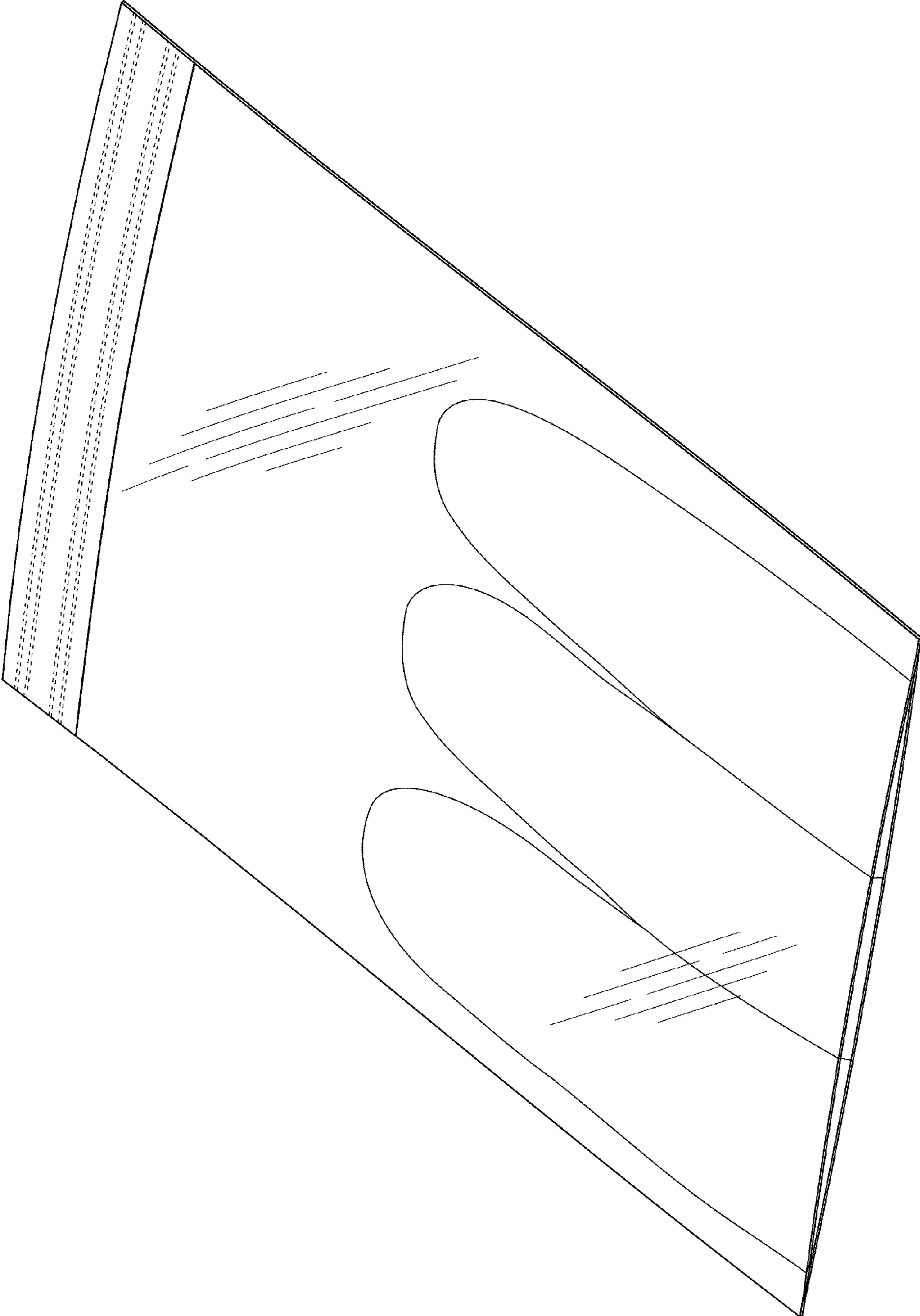

FIG. 20

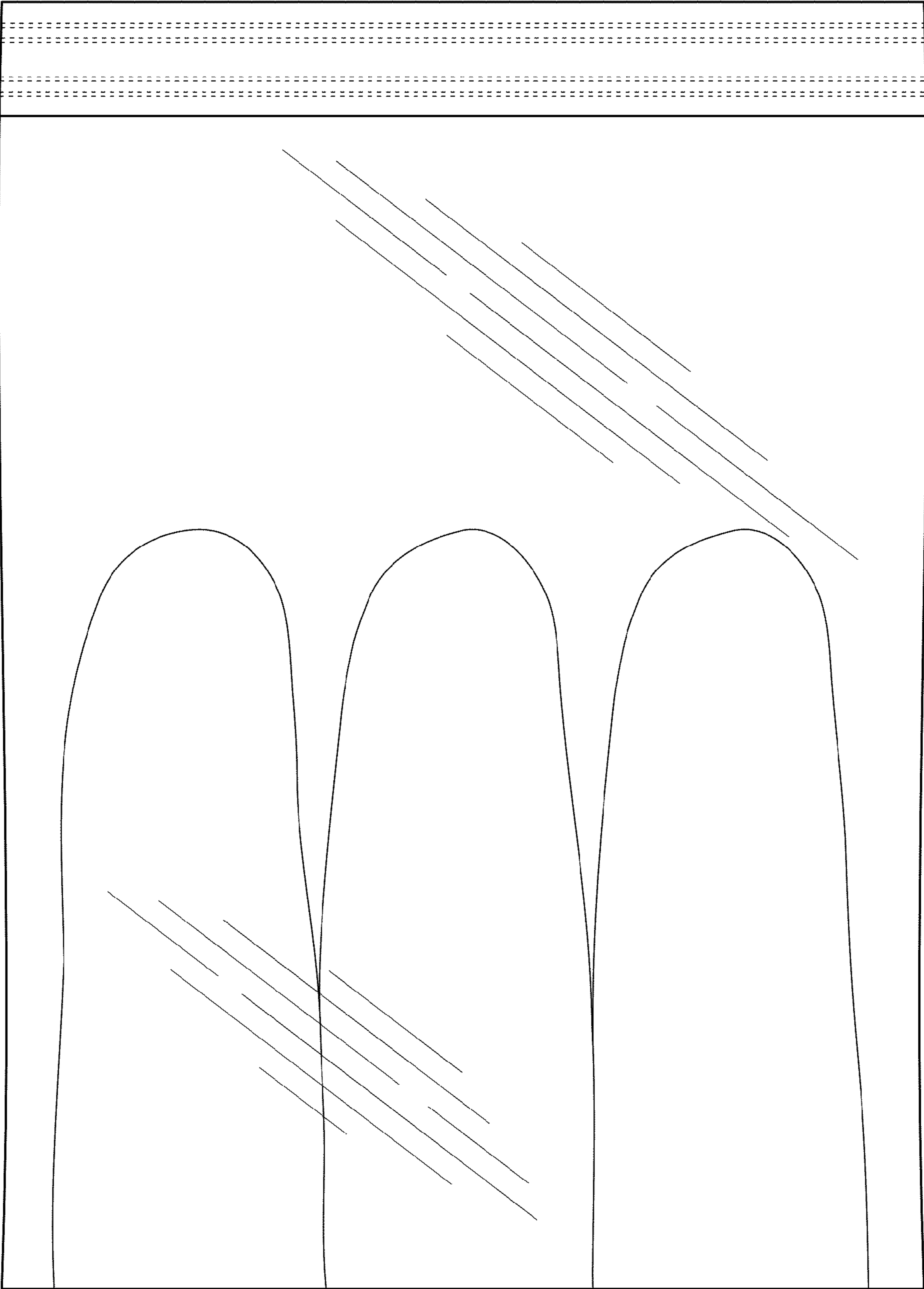

FIG. 21

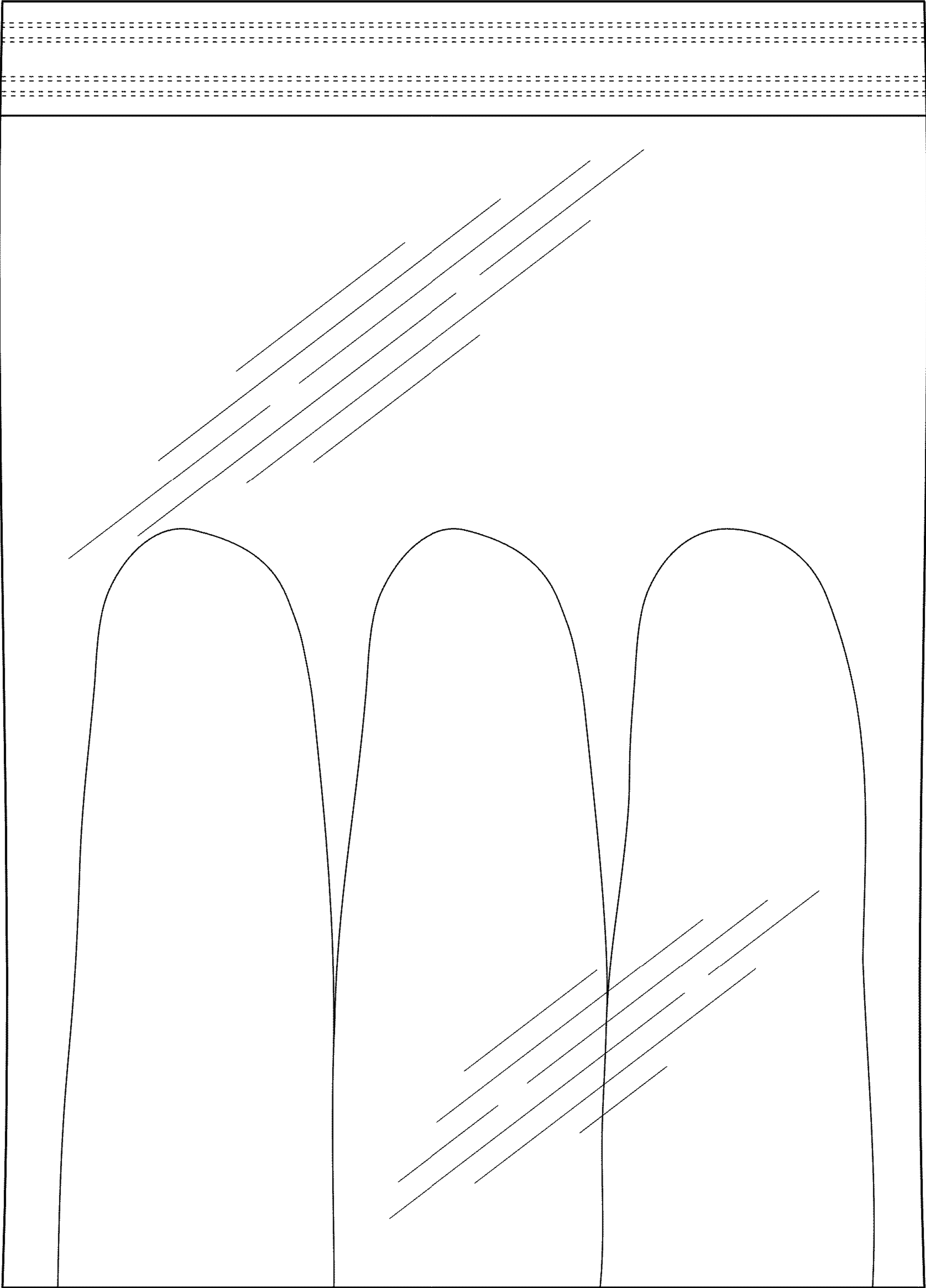

FIG. 22

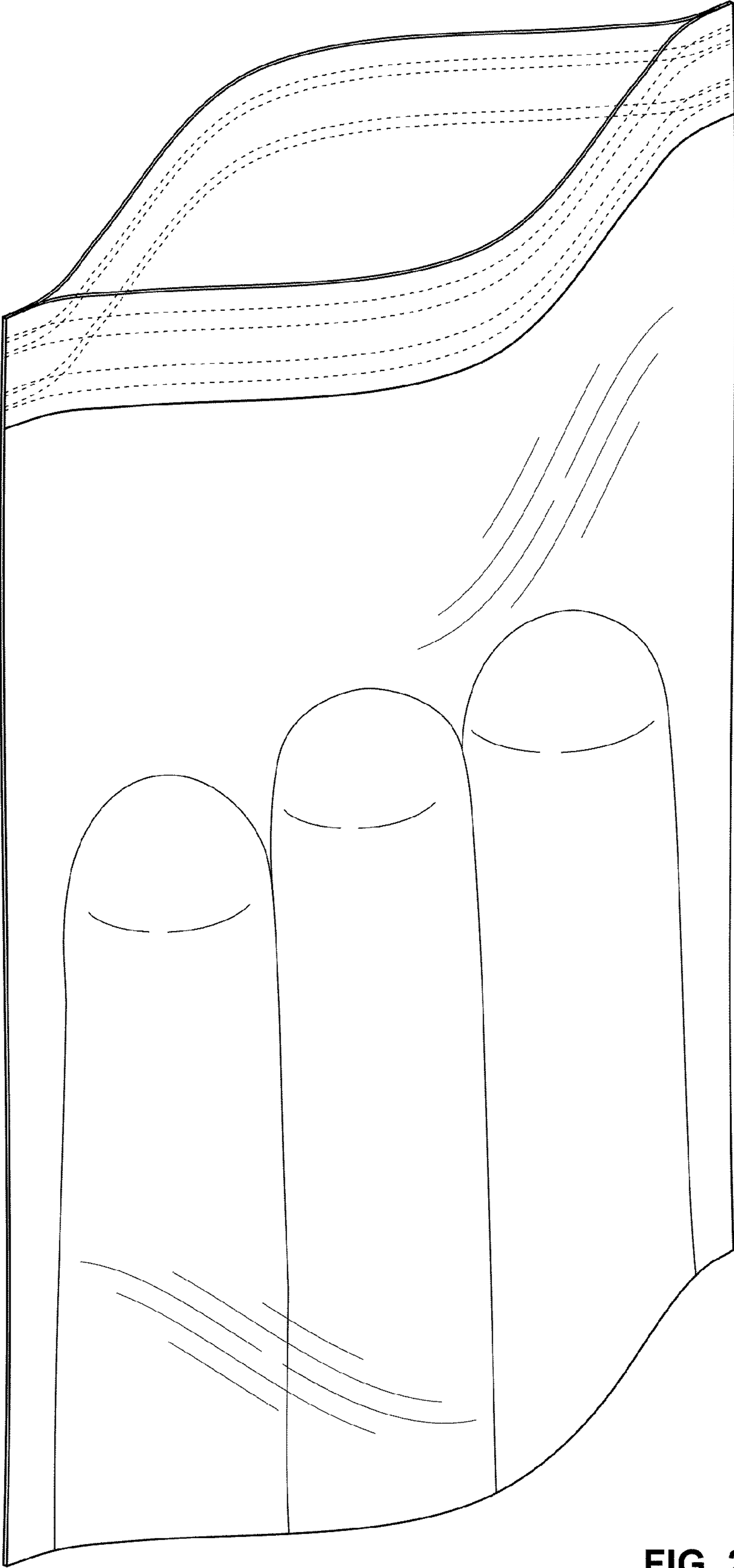

FIG. 23

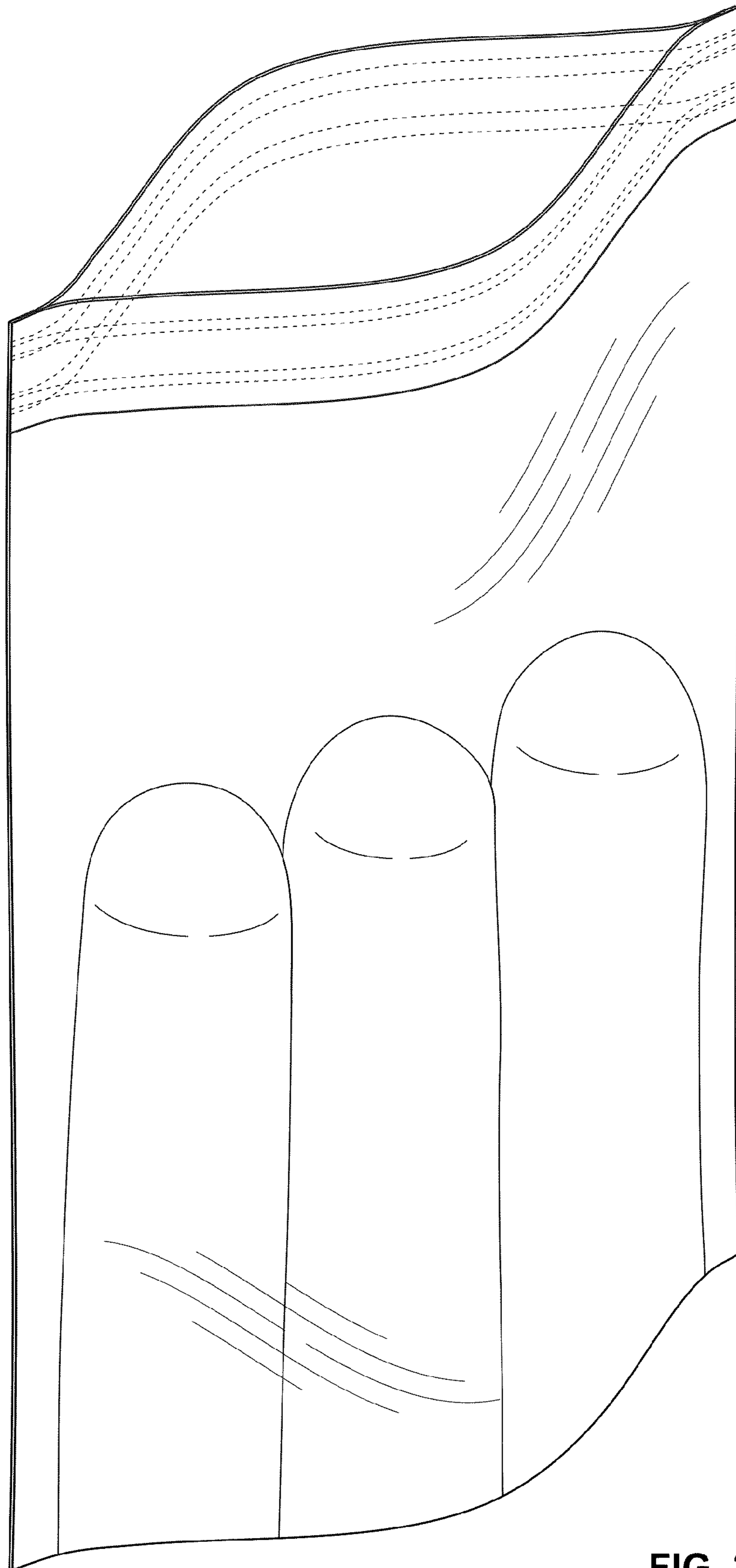

FIG. 24

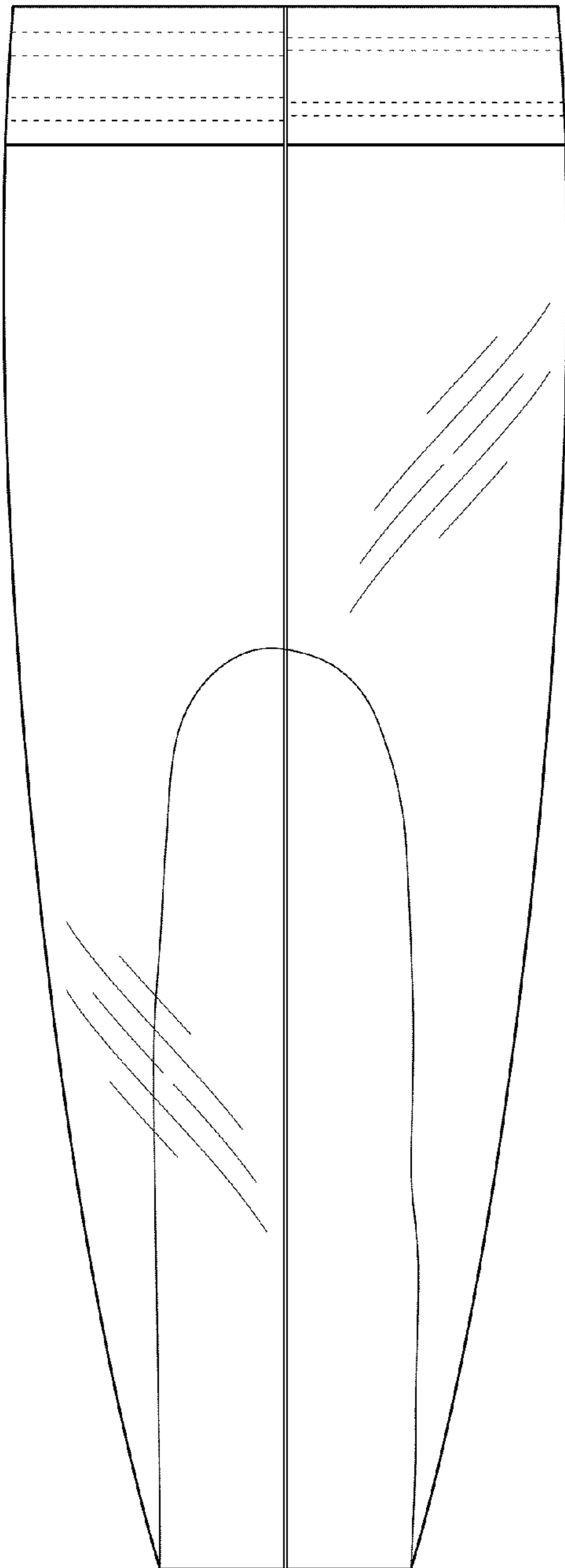

FIG. 25

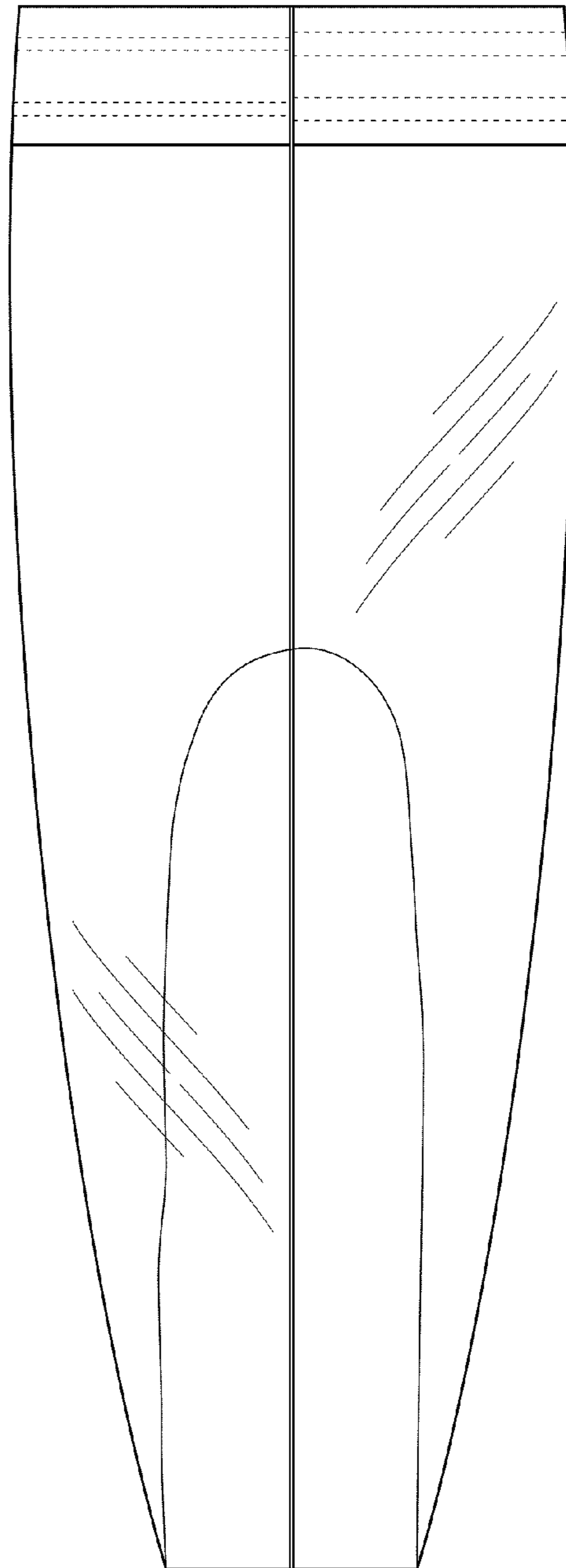

FIG. 26

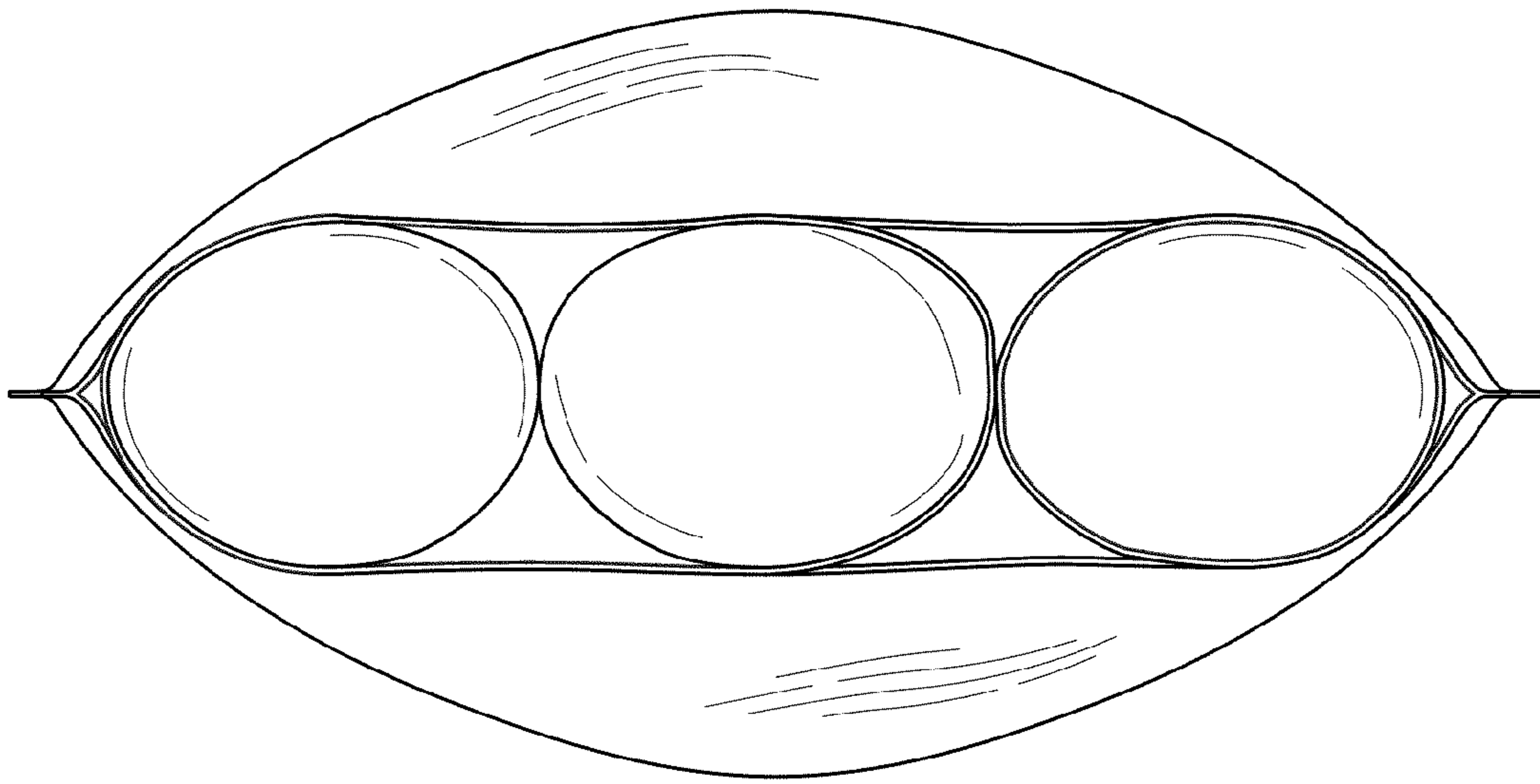

FIG. 27

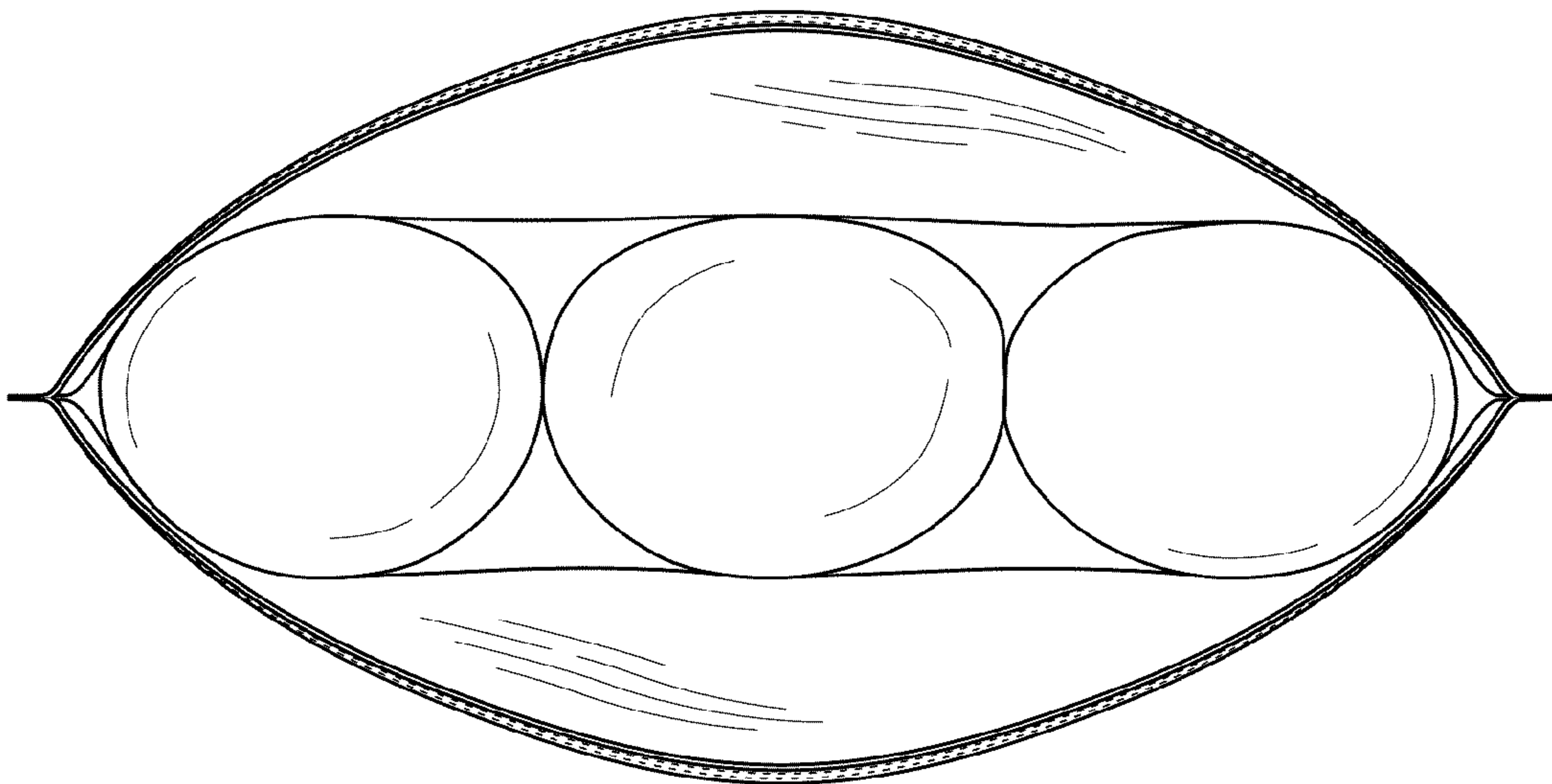

FIG. 28

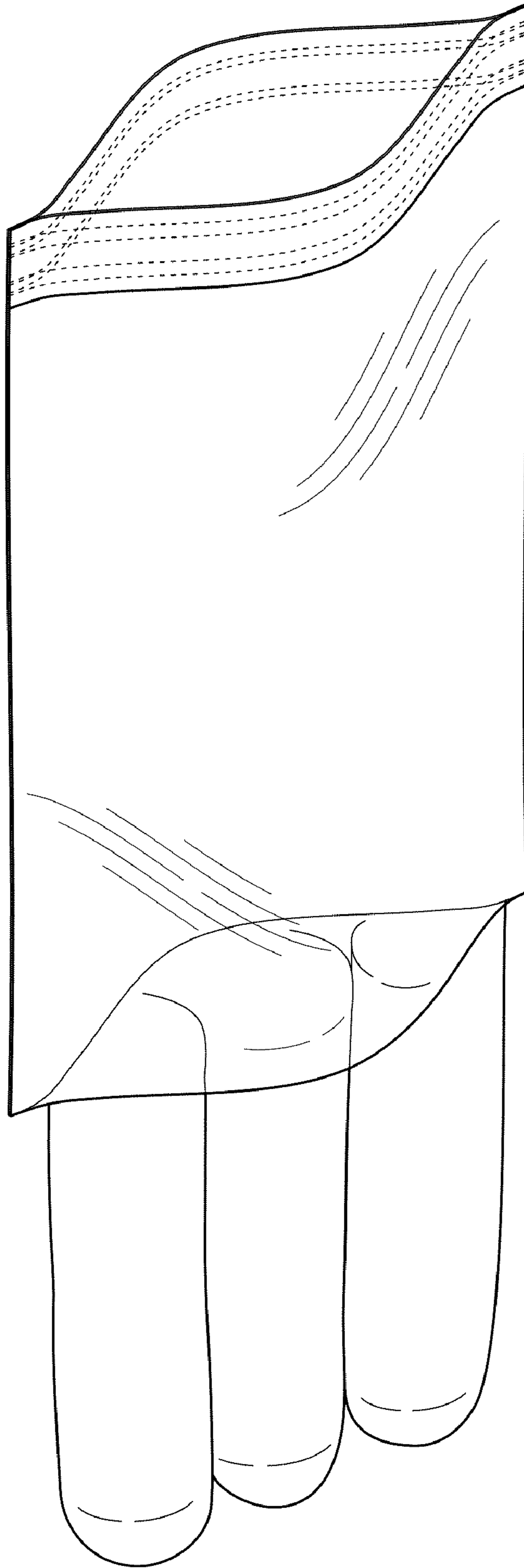

FIG. 29

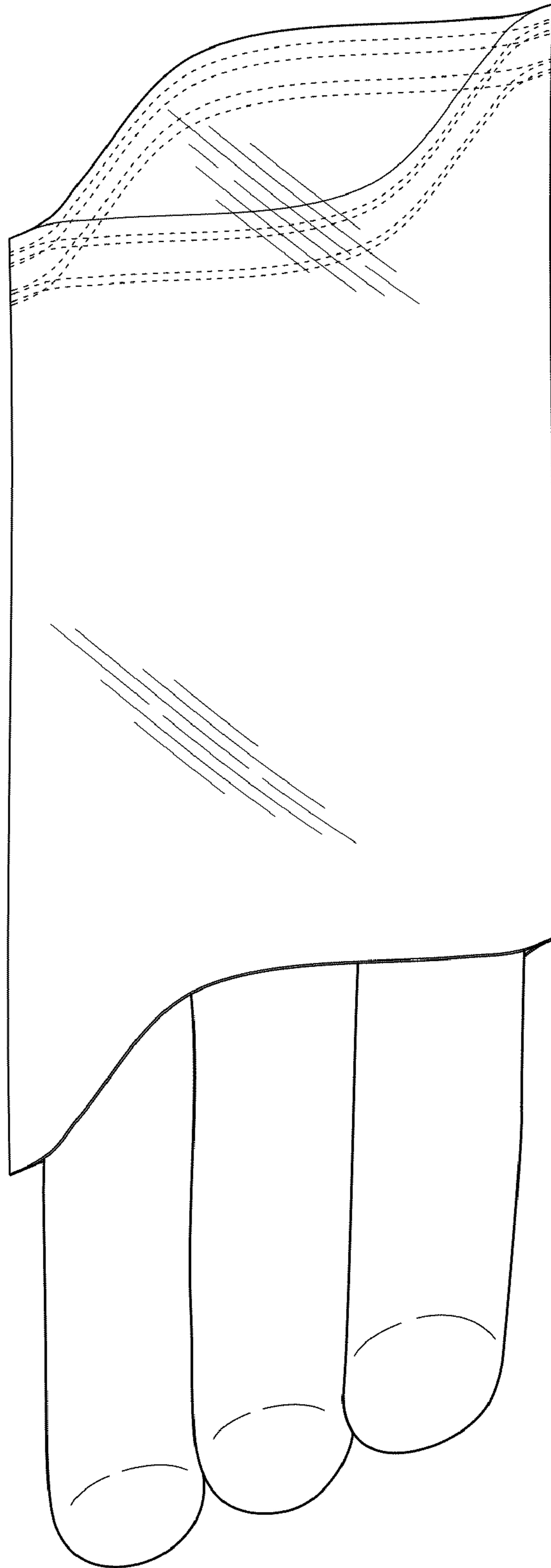

FIG. 30