



US00D644478S

(12) **United States Design Patent**  
**Czach**

(10) **Patent No.:** **US D644,478 S**

(45) **Date of Patent:** **\*\* Sep. 6, 2011**

(54) **FOOD CHOPPER**

(75) Inventor: **Matthew G. Czach**, Kalamazoo, MI  
(US)

(73) Assignee: **Whirlpool Corporation**, Benton Harbor,  
MI (US)

(\*\*) Term: **14 Years**

(21) Appl. No.: **29/386,174**

(22) Filed: **Feb. 25, 2011**

(51) **LOC (9) Cl.** ..... **31-00**

(52) **U.S. Cl.** ..... **D7/372; D7/376; D7/378; D7/384**

(58) **Field of Classification Search** ..... D7/305-311,  
D7/317-318, 368, 372, 376-386, 412-415,  
D7/665; D15/82; 99/326, 348, 508-511;  
241/30-37.5, 101.01-101.2, 166-169.1,  
241/285.1-285.3, 291, 292.1; 366/64-67,  
366/98, 142, 197-211, 241-254, 279-292,  
366/341-347; 416/75-76, 70 R, 163

See application file for complete search history.

(56) **References Cited**

**U.S. PATENT DOCUMENTS**

D290,677 S \* 7/1987 Stutzer et al. .... D7/384  
D311,659 S \* 10/1990 Storsberg ..... D7/384  
D406,154 S \* 2/1999 Copland et al. .... D15/82

D426,423 S \* 6/2000 Lee ..... D7/384  
D445,636 S \* 7/2001 Spagnolo ..... D7/384  
D502,842 S \* 3/2005 Hallar ..... D7/384  
7,028,930 B2 \* 4/2006 Carnevale ..... 241/37.5  
D563,154 S \* 3/2008 Comstock et al. .... D7/378  
7,520,453 B2 \* 4/2009 Clapp et al. .... 241/37.5  
D630,467 S \* 1/2011 Harrod ..... D7/376

\* cited by examiner

*Primary Examiner* — Ricky Pham

(74) *Attorney, Agent, or Firm* — Tara M. Hartman; Barnes &  
Thornburg, LLP

(57) **CLAIM**

I claim the ornamental design for a food chopper, as shown  
and described.

**DESCRIPTION**

FIG. 1 is a front perspective view of a design of the food  
chopper;

FIG. 2 is a front elevation view of the food chopper of FIG. 1;

FIG. 3 is a first side elevation view of the food chopper of FIG.

1, the second side elevation view being a mirror image of the

first side elevation view of FIG. 3;

FIG. 4 is a rear elevation view of the food chopper of FIG. 1;

FIG. 5 is a top plan view of the food chopper of FIG. 1; and,

FIG. 6 is a bottom plan view of the food chopper of FIG. 1.

The portion shown in broken lines is for illustrative purposes  
only and forms no part of the claimed design.

**1 Claim, 6 Drawing Sheets**

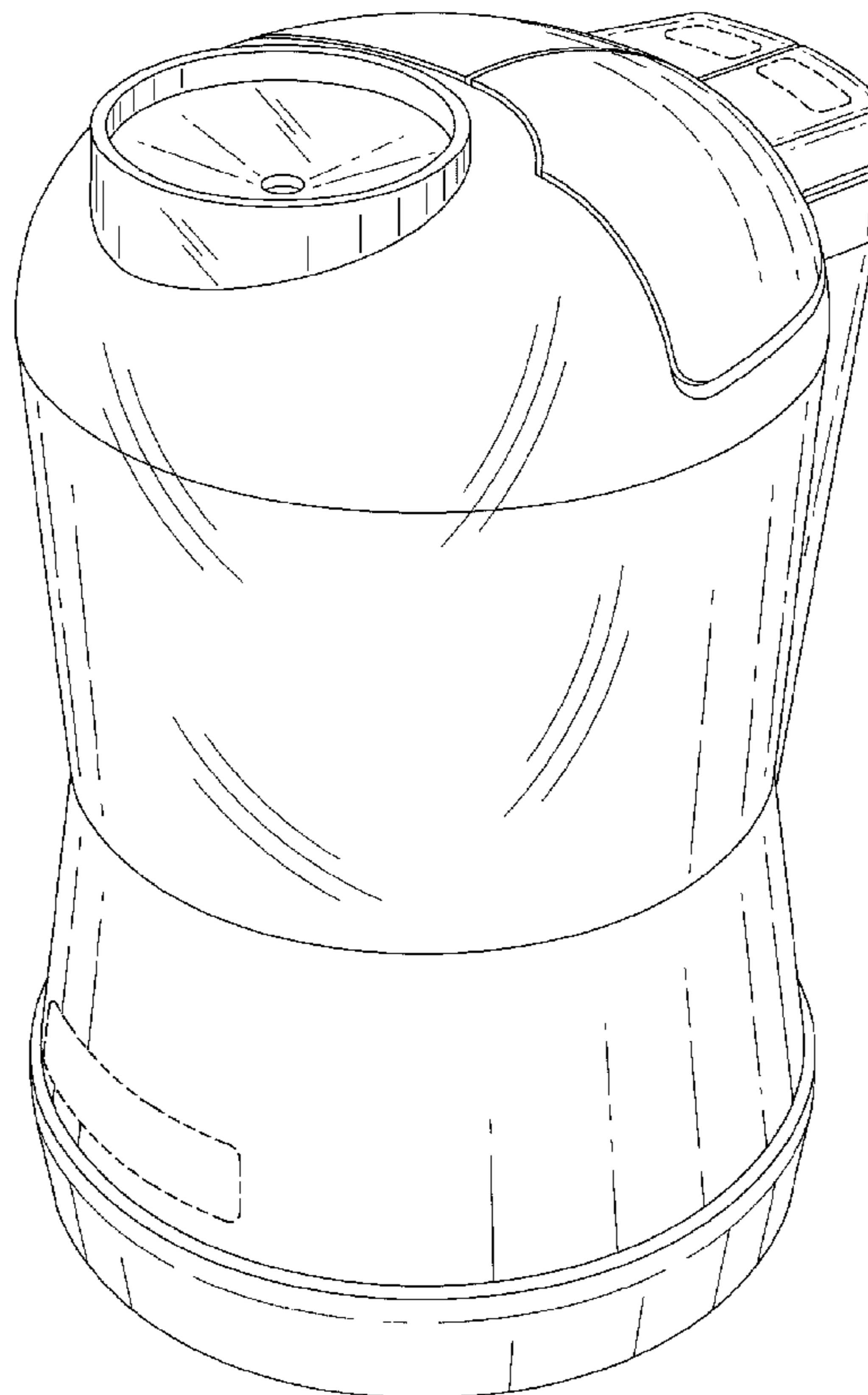

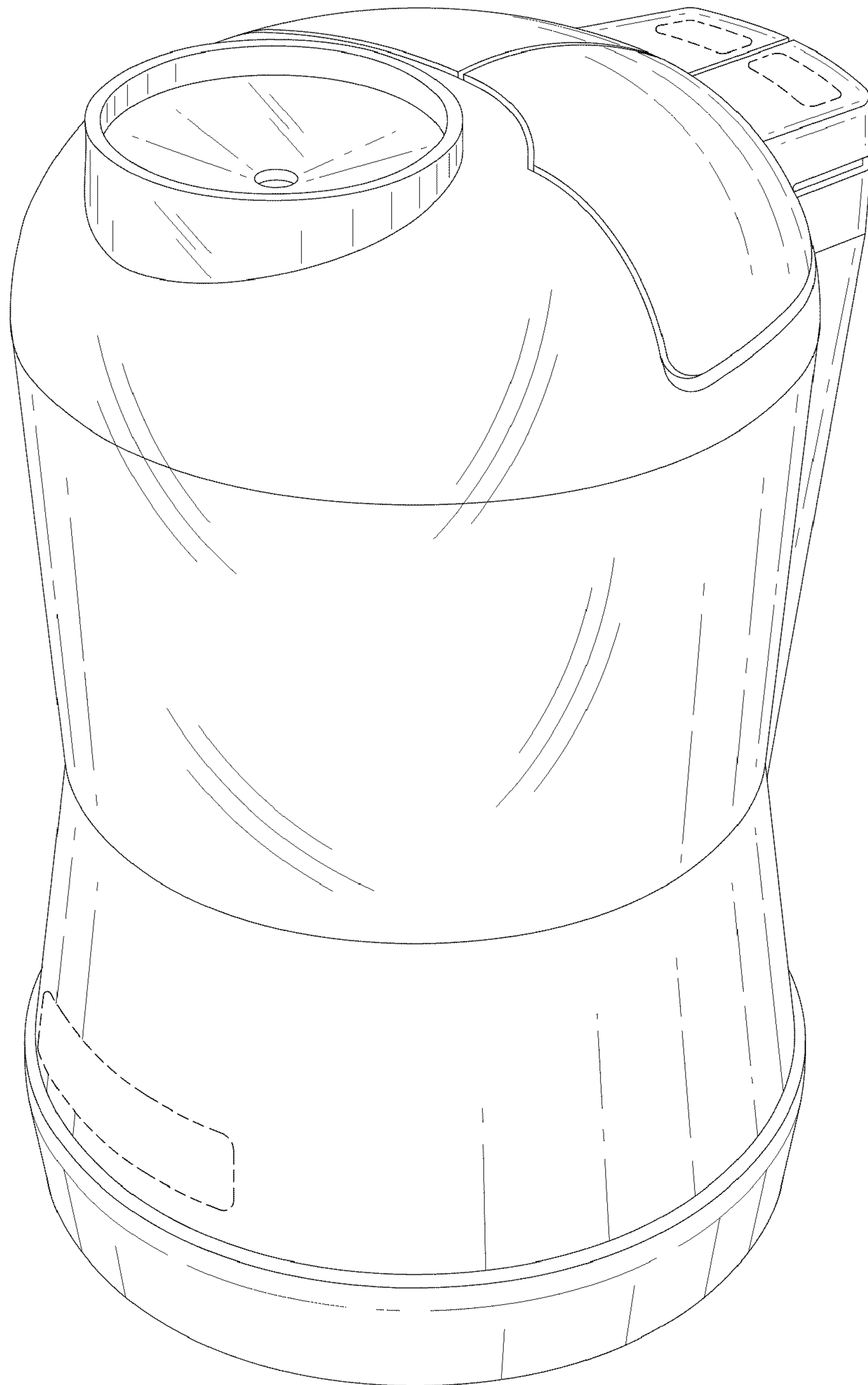

Fig. 1

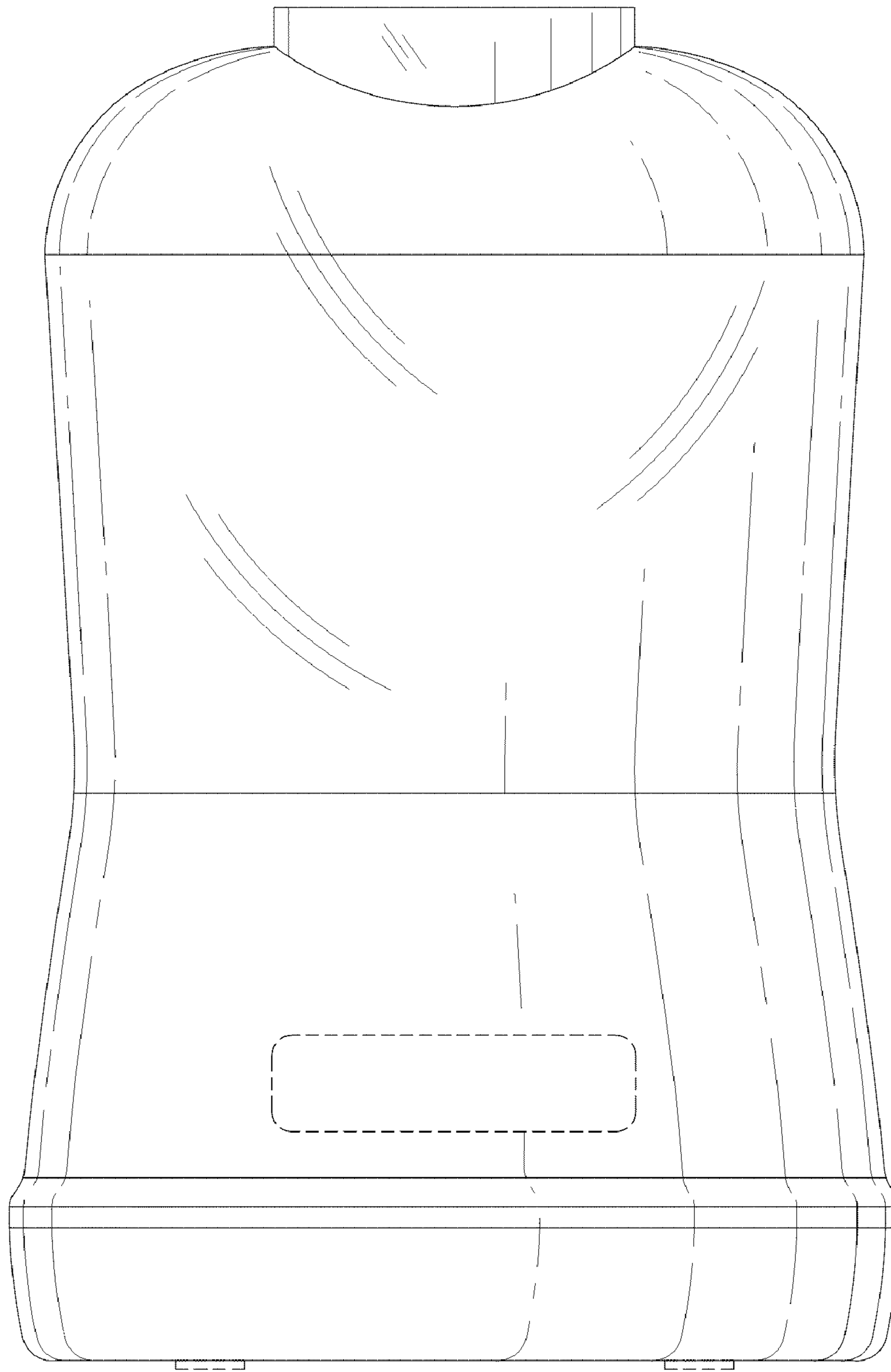

Fig. 2

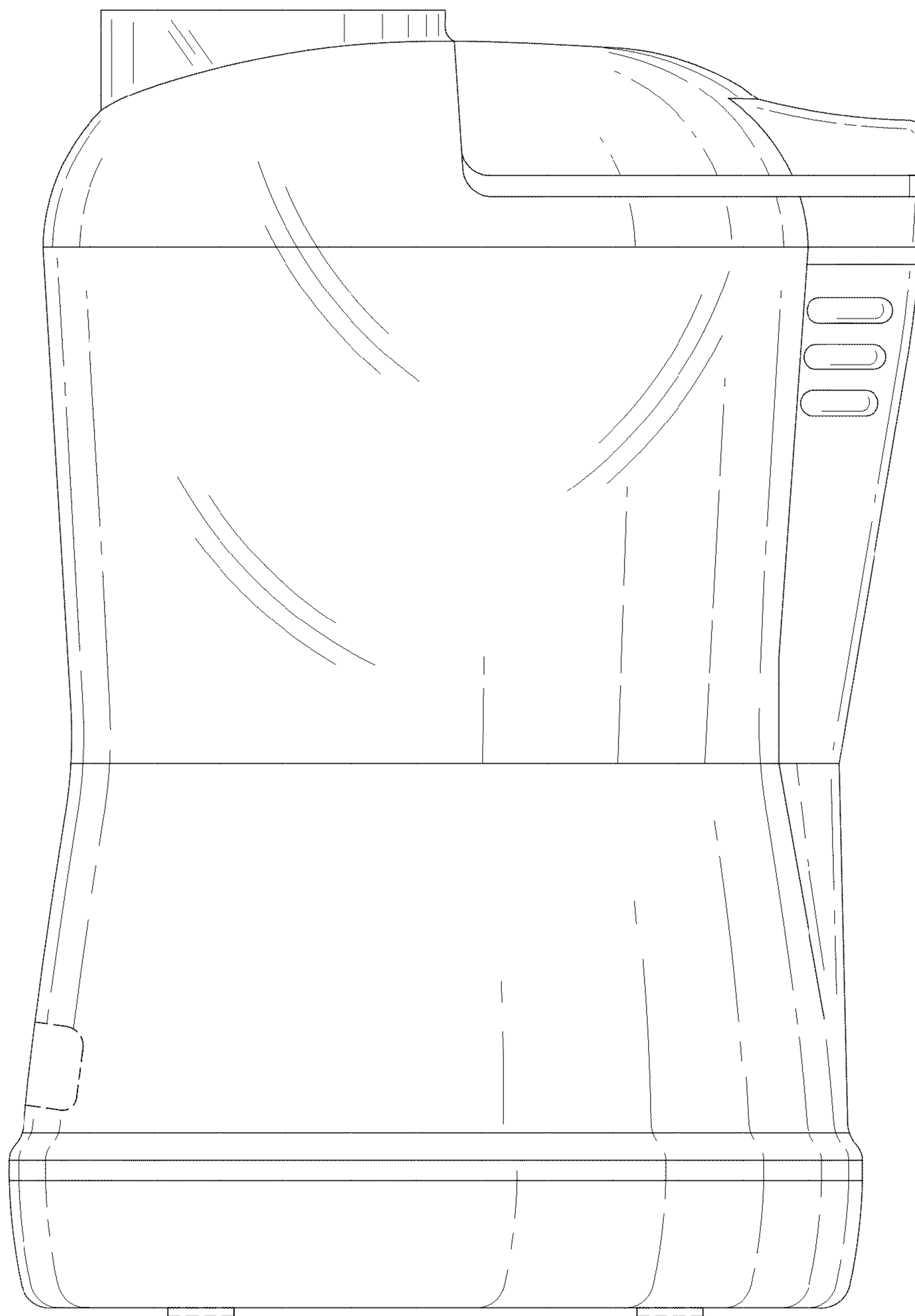

Fig. 3

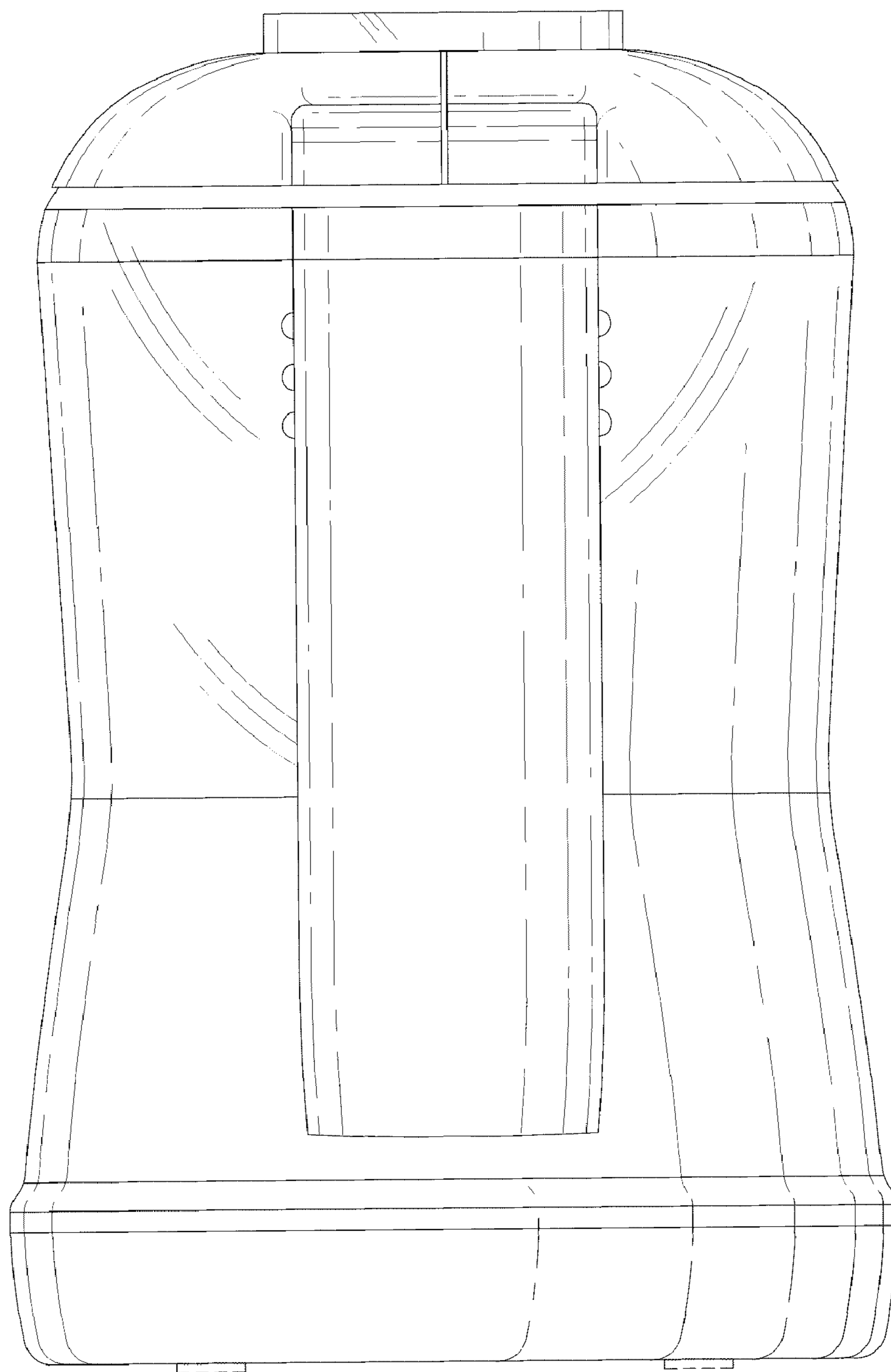

Fig. 4

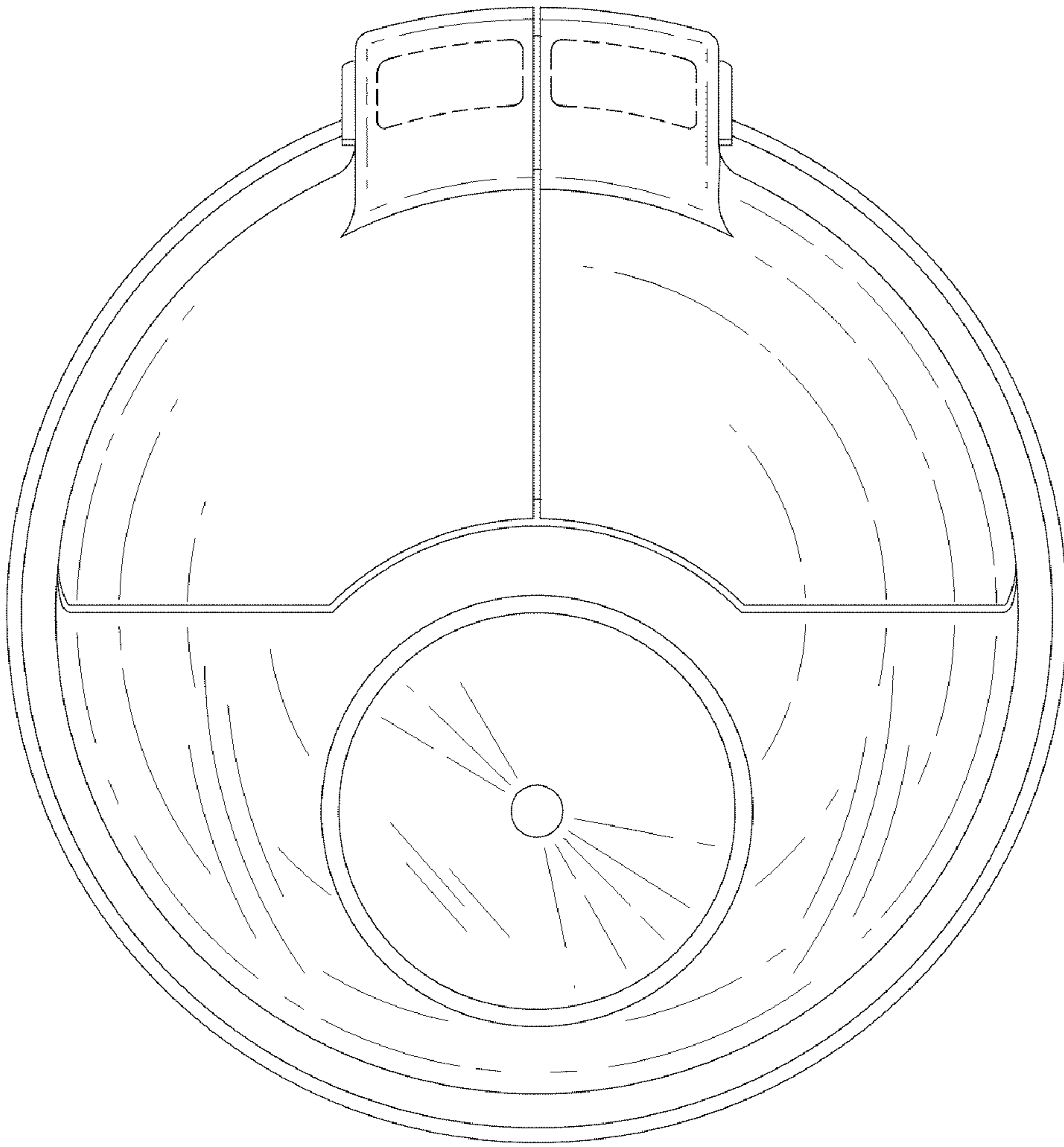

Fig. 5

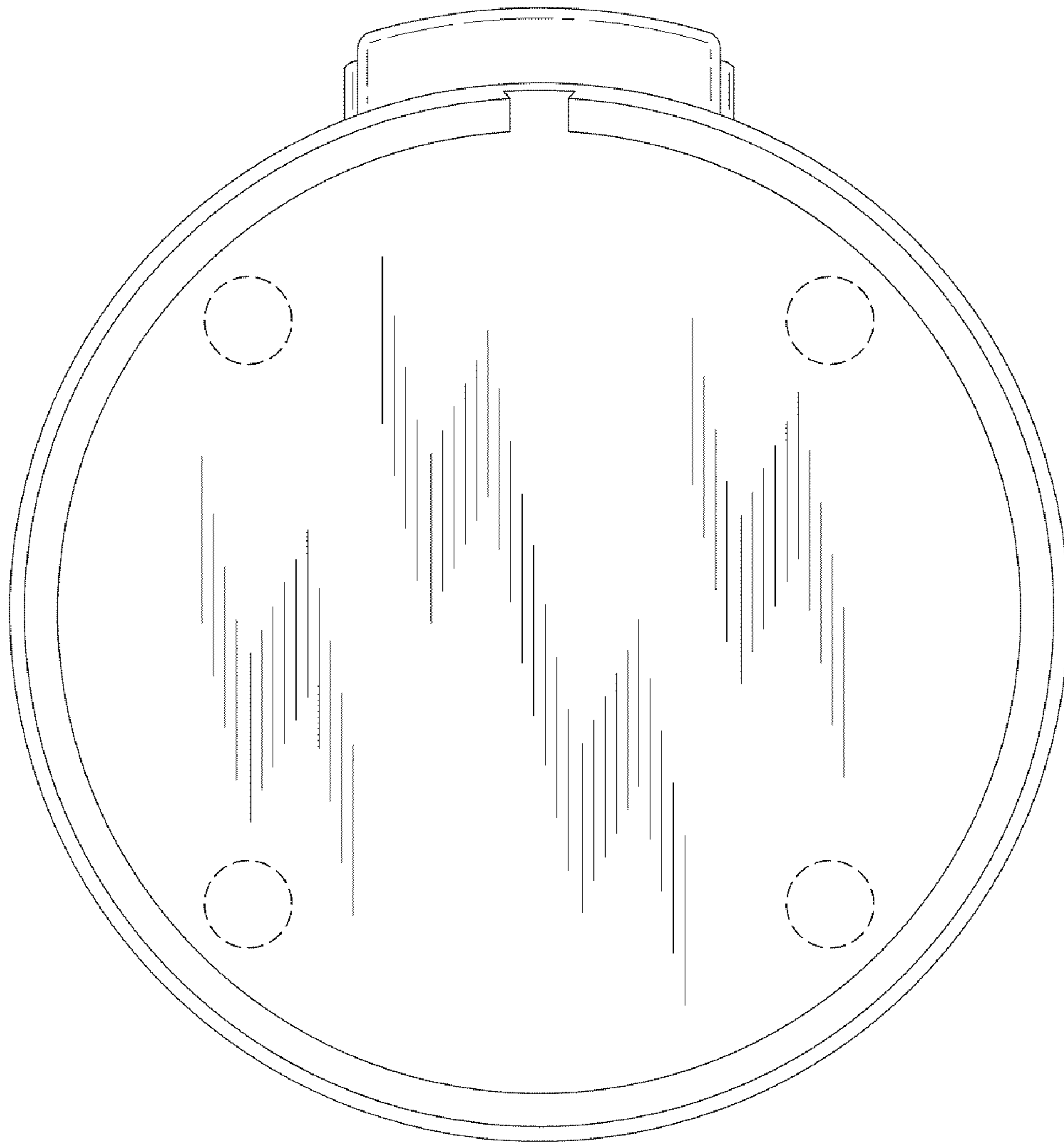

Fig. 6