



US00D644467S

(12) **United States Design Patent**
Zannella

(10) **Patent No.:** **US D644,467 S**
(45) **Date of Patent:** **** Sep. 6, 2011**

(54) **TABLE**

(76) Inventor: **Anna Zannella**, Pontecurone (IT)

(**) Term: **14 Years**

(21) Appl. No.: **29/360,943**

(22) Filed: **May 3, 2010**

(51) **LOC (9) Cl.** **06-06**

(52) **U.S. Cl.** **D6/511**

(58) **Field of Classification Search** D6/480-489,
D6/429-431, 495-499, 511; 108/150, 153.1,
108/155, 156, 161

See application file for complete search history.

(56) **References Cited**

U.S. PATENT DOCUMENTS

D279,742 S * 7/1985 DiPersia D6/484
D327,386 S * 6/1992 Grosfillex D6/484
D491,387 S * 6/2004 Muller D6/480

* cited by examiner

Primary Examiner — Janice Seeger

(57) **CLAIM**

The ornamental design for a table, as described and shown.

DESCRIPTION

FIG. 1 is a perspective view of the preferred embodiment of a table, showing my new design;

FIG. 2 is a top plan view thereof, the bottom plan being a mirror image thereof;

FIG. 3 is a front elevational view thereof; the rear elevational view being a mirror image thereof;

FIG. 4 is a right side elevational view thereof, the left side being a mirror image thereof.

FIG. 5 is a perspective view of an alternative embodiment of a table, showing my design showing the table with different size and proportion;

FIG. 6 is a top plan view thereof, the bottom plan being a mirror image thereof;

FIG. 7 is a front elevational view thereof; the rear elevational view being a mirror image thereof; and,

FIG. 8 is a right side elevational view thereof, the left side being a mirror image thereof.

The phantom lines in FIGS. 1-8 are for illustrative purposes only to show sample legs or base and form no part of the claimed design.

1 Claim, 2 Drawing Sheets

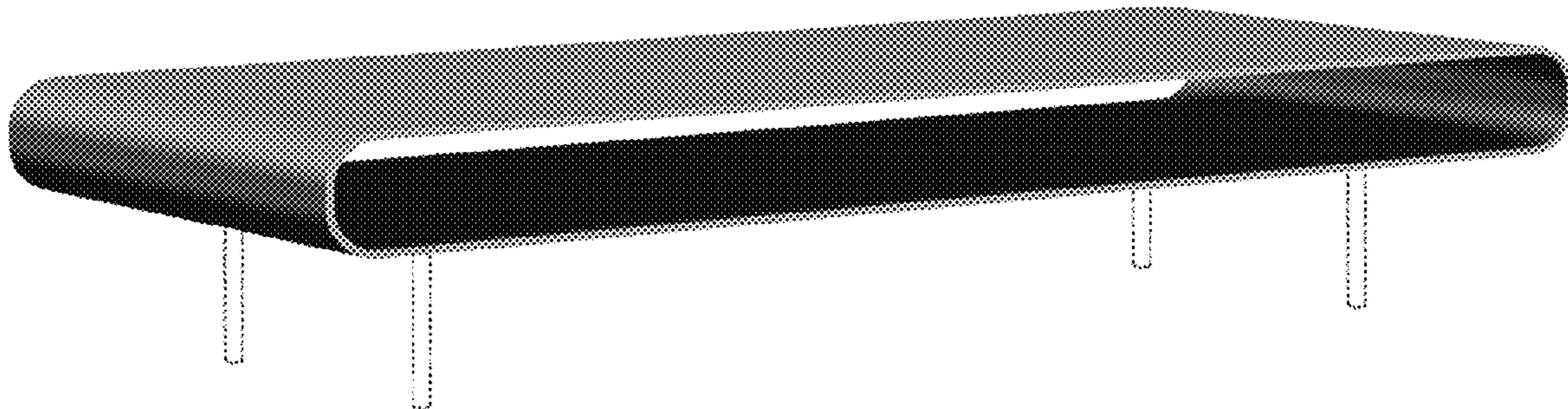

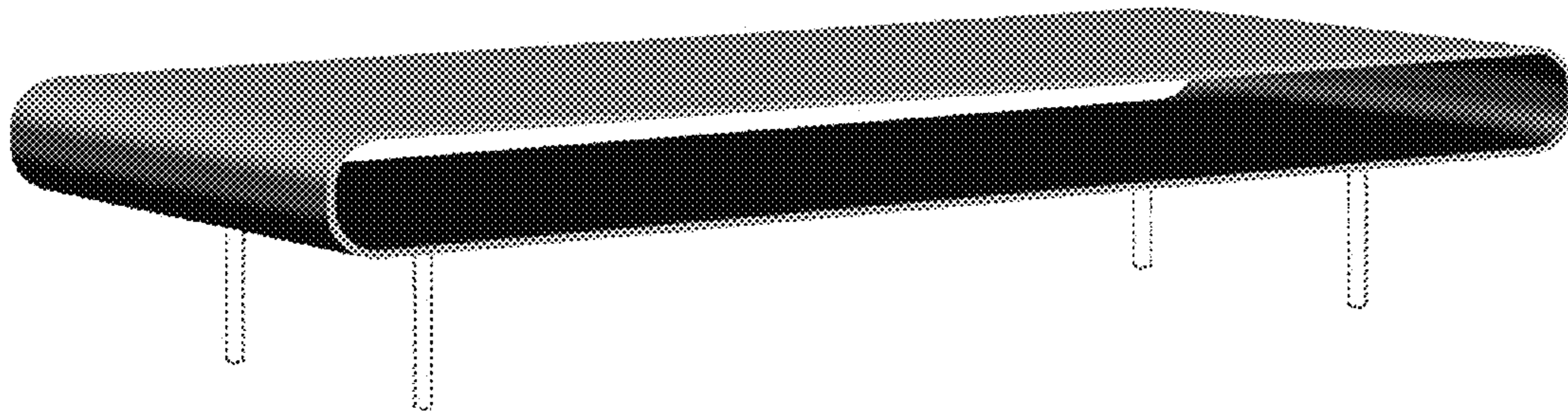

Fig. 1

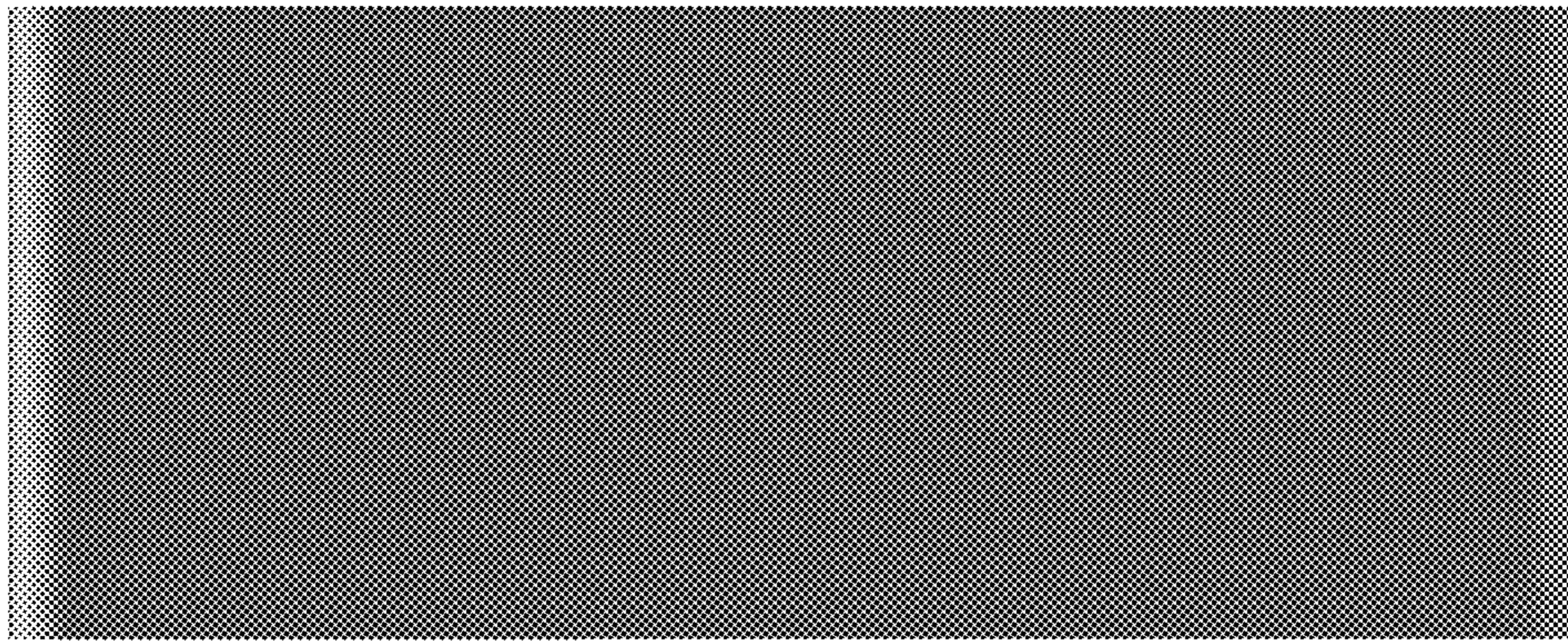

Fig. 2

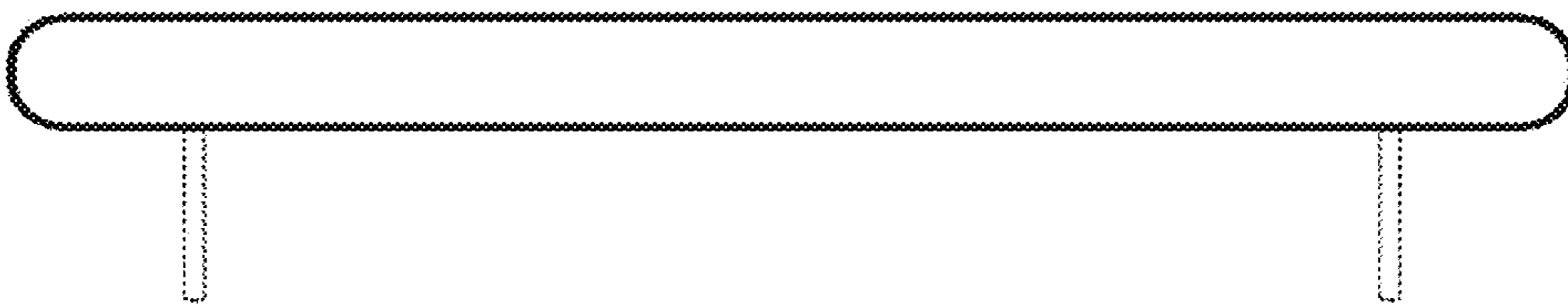

Fig. 3



Fig. 4

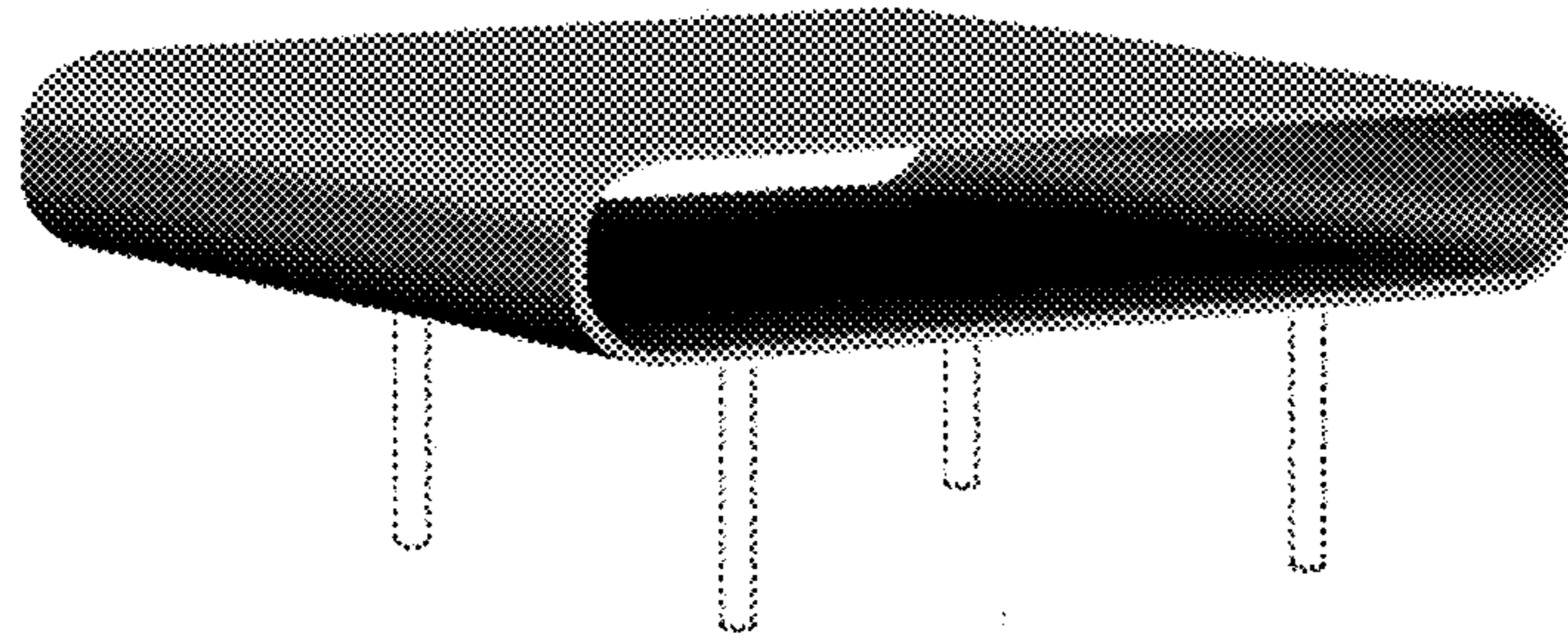

Fig. 5

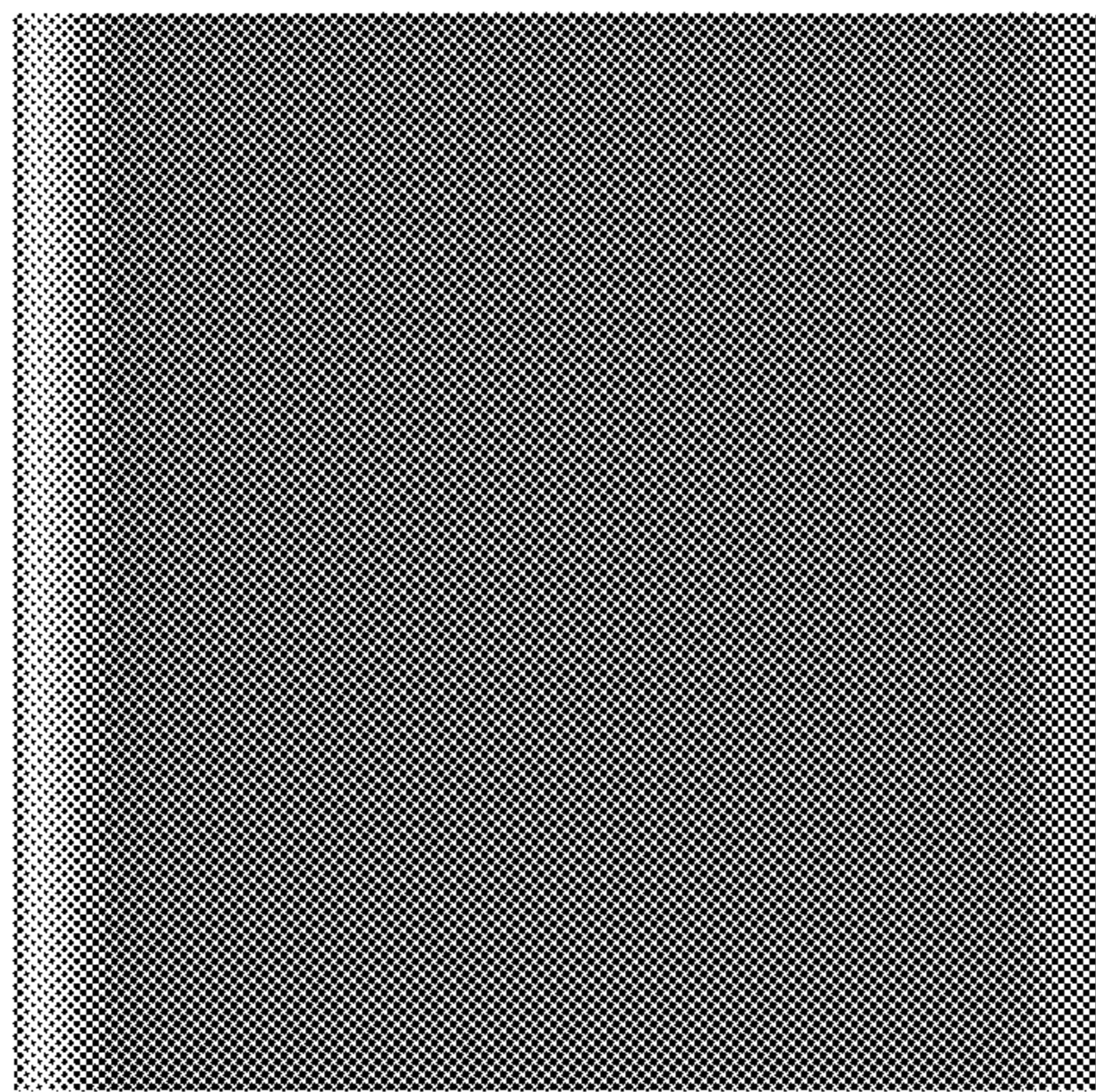

Fig. 6

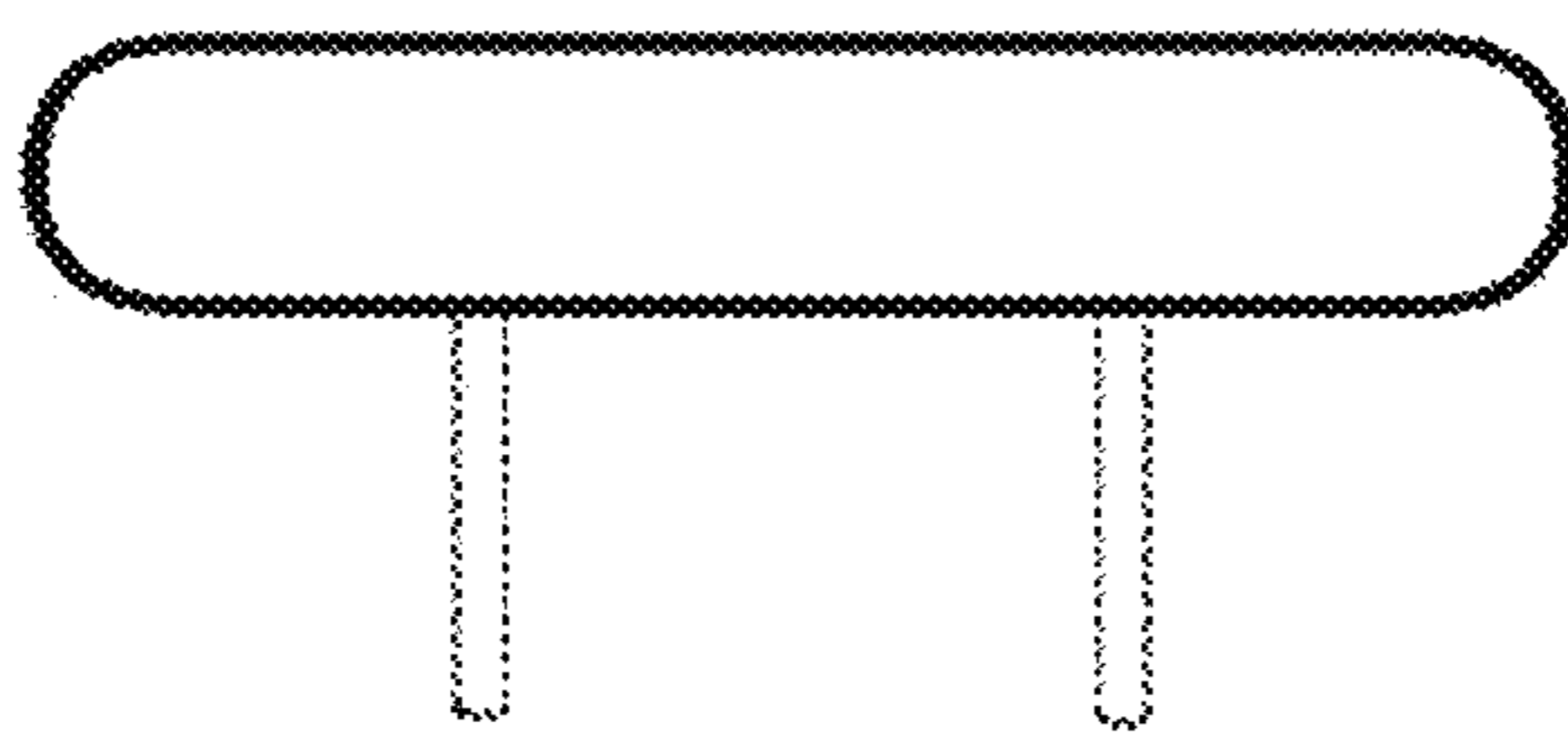

Fig. 7



Fig. 8