



US00D644437S

(12) **United States Design Patent**
Lintula

(10) **Patent No.:** **US D644,437 S**

(45) **Date of Patent:** **** Sep. 6, 2011**

(54) **PACKAGING CONTAINER**

(75) Inventor: **Pekka Lintula**, Lapua (FI)

(73) Assignee: **Nammo Lapua Oy**, Lapua (FI)

(**) Term: **14 Years**

(21) Appl. No.: **29/364,335**

(22) Filed: **Jun. 22, 2010**

(30) **Foreign Application Priority Data**

Dec. 22, 2009 (EM) 001650870

(51) **LOC (9) Cl.** **03-01**

(52) **U.S. Cl.** **D3/294**

(58) **Field of Classification Search** D3/272-273,
D3/284, 294; 206/1.8, 334, 315, 443, 214
See application file for complete search history.

(56) **References Cited**

U.S. PATENT DOCUMENTS

D414,335 S *	9/1999	Cheyn	D3/276
D518,957 S *	4/2006	DeCarlo et al.	D3/302
D563,105 S *	3/2008	Rothschild	D3/302
D578,758 S *	10/2008	Stevens et al.	D3/272
D580,171 S *	11/2008	Weng et al.	D3/294

* cited by examiner

Primary Examiner — Holly Baynham

(74) *Attorney, Agent, or Firm* — Klauber & Jackson LLC

(57) **CLAIM**

The ornamental design for a packaging container, as shown and described.

DESCRIPTION

FIG. 1 is an upper left perspective view showing the top, front and left side of the packaging container of my new design; FIG. 2 is a front view thereof; FIG. 3 is a top view thereof; FIG. 4 is a left-side view thereof, the right side being the mirror image thereof; FIG. 5 is a rear view thereof; FIG. 6 is bottom view thereof; FIG. 7 is an upper right perspective view of the packaging container in an opened position showing rack inserts; FIG. 8 is a top perspective view of the design of FIG. 7, showing a full view of the sides and bottom of the interior of the packaging container of FIG. 7; FIG. 9 is a perspective view with the racks removed from the lid and the inside, but showing corresponding rings the rack is inserted into; FIG. 10 is a top perspective view of the design of FIG. 9, showing a full view of the sides and bottom of the interior of the packaging container of FIG. 9; FIG. 11 is a perspective view in an opened position of the rack in an alternate position; and, FIG. 12 is a top perspective view of the design of FIG. 11, showing a full view of the sides and bottom of the interior of the packaging container of FIG. 11.

1 Claim, 6 Drawing Sheets

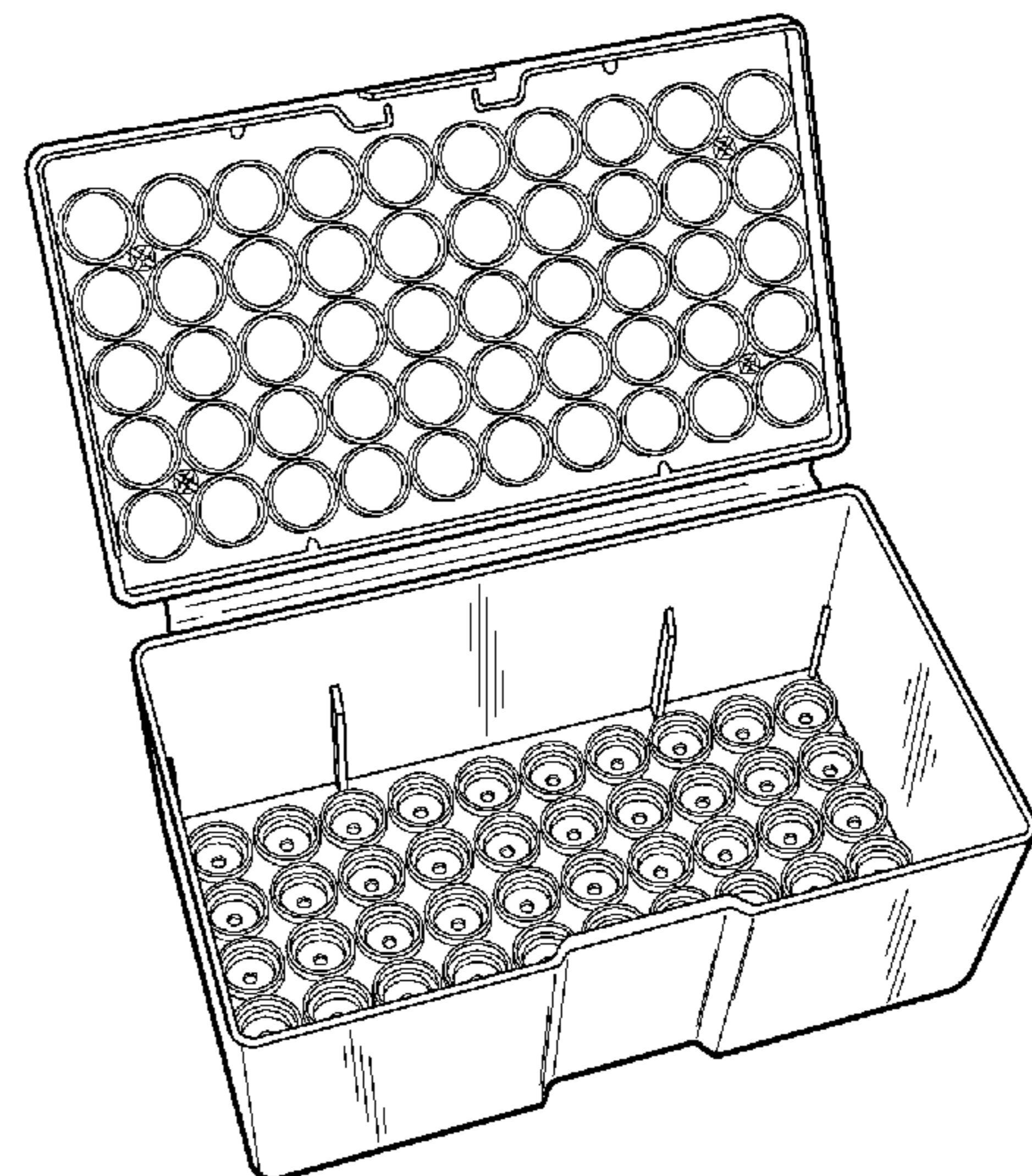
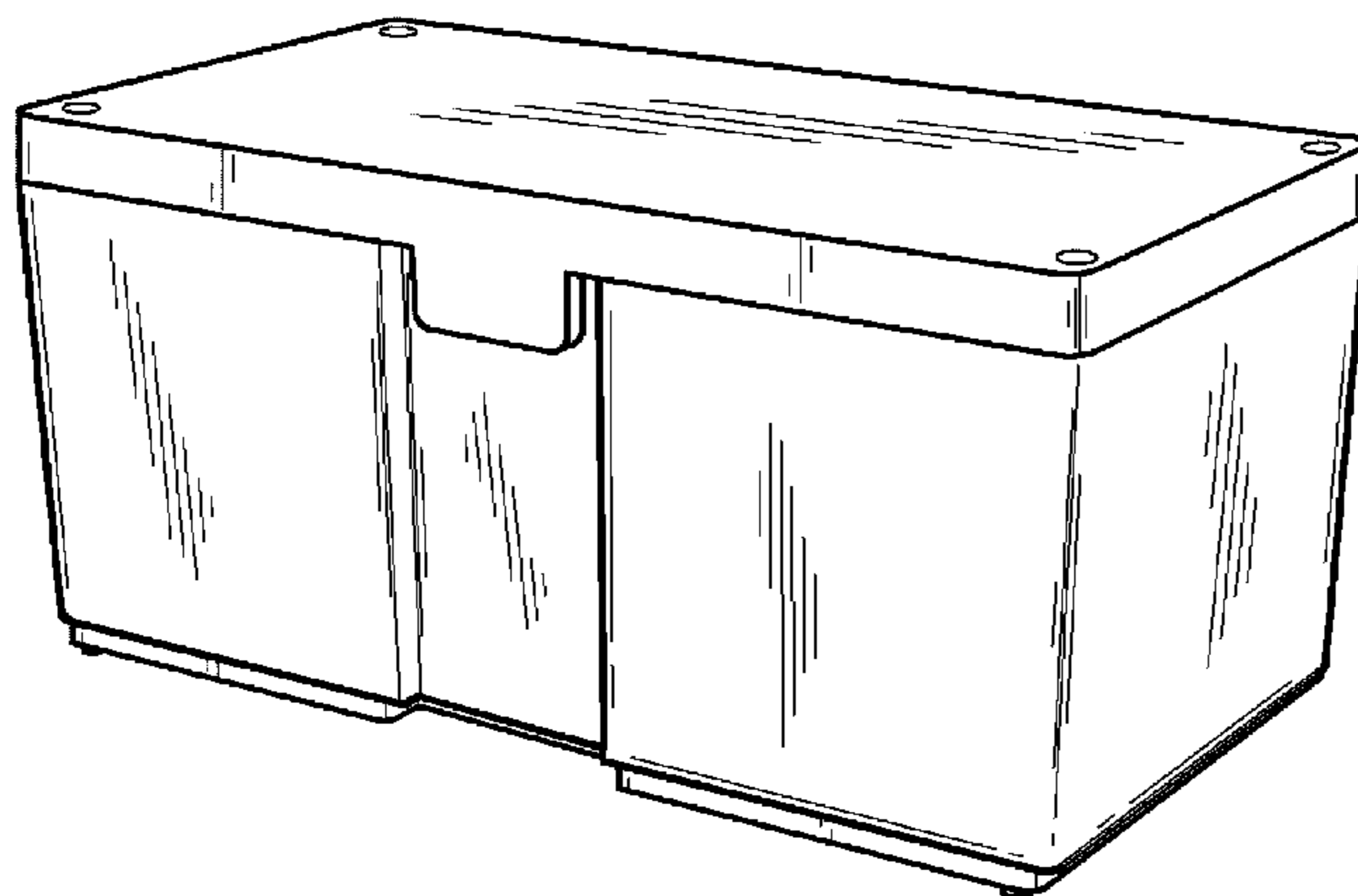

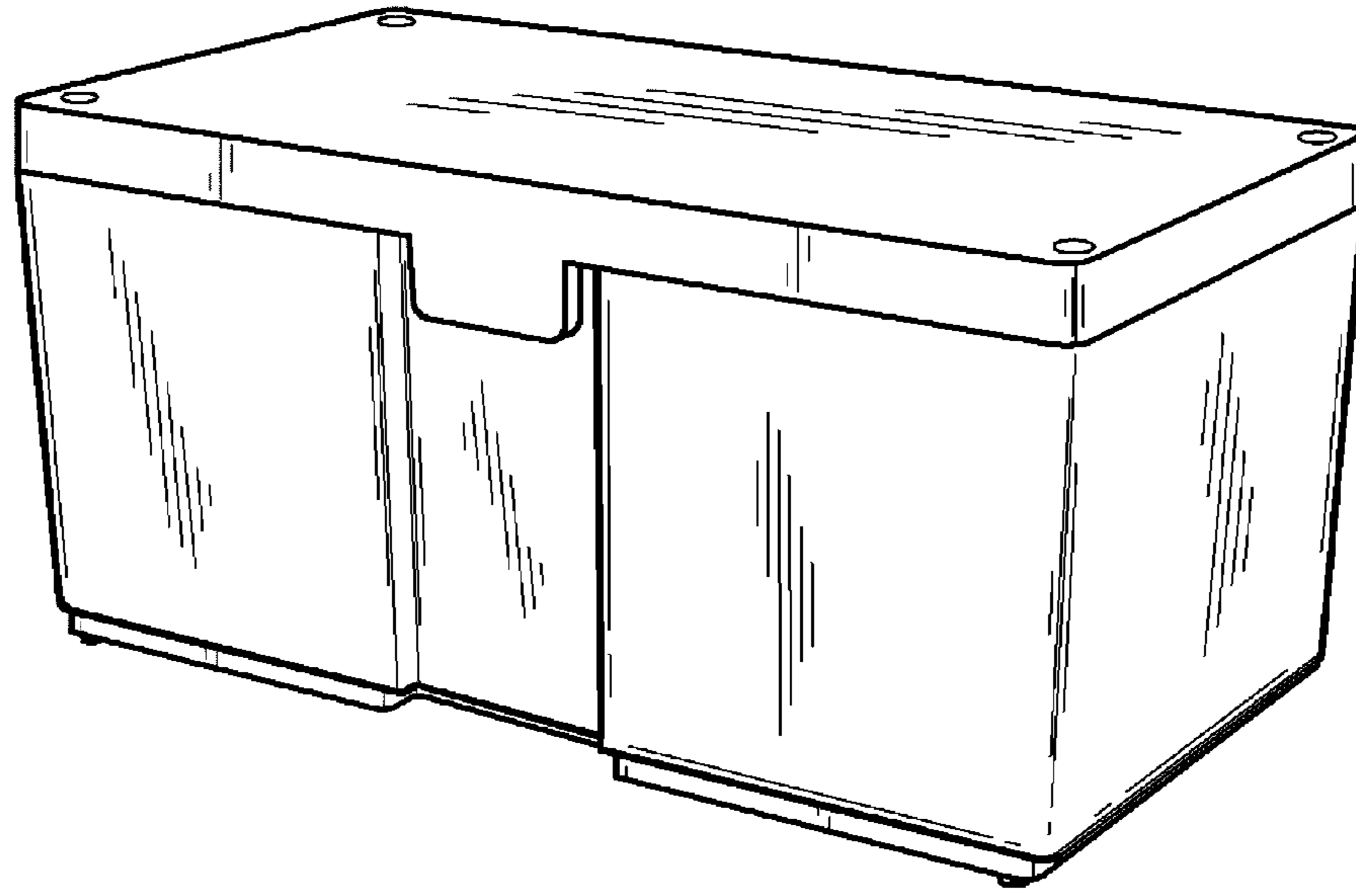

FIG. 1

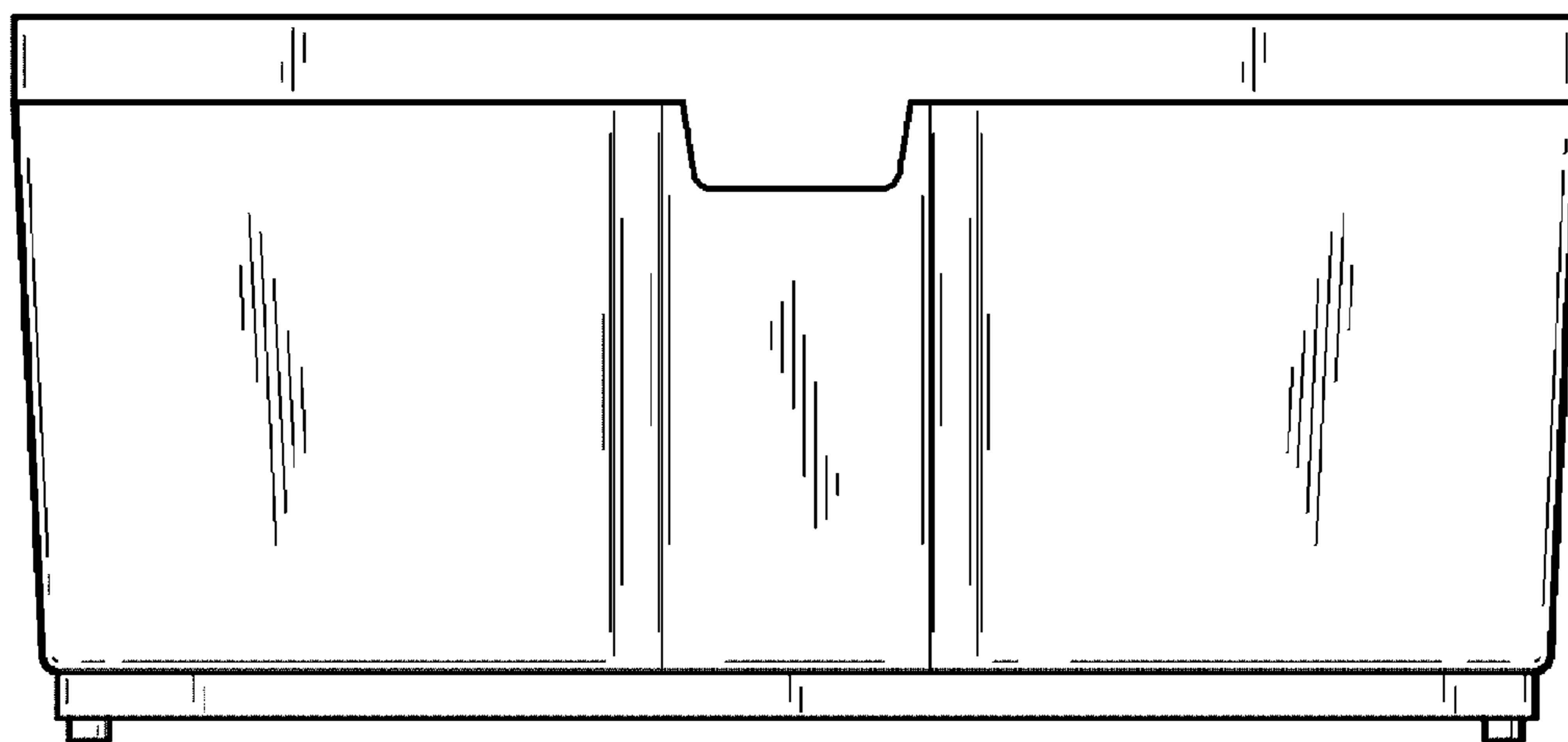

FIG. 2

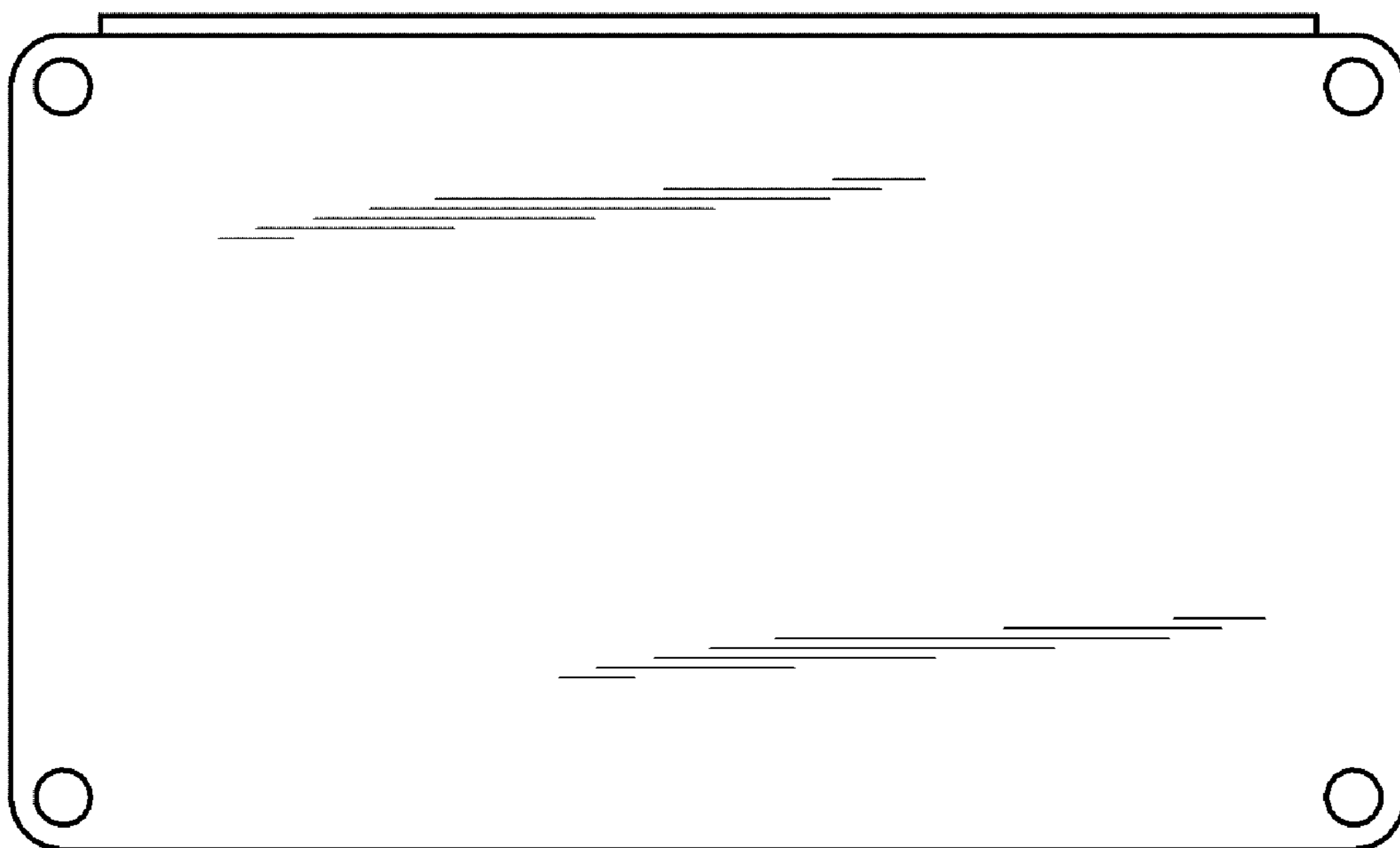

FIG. 3

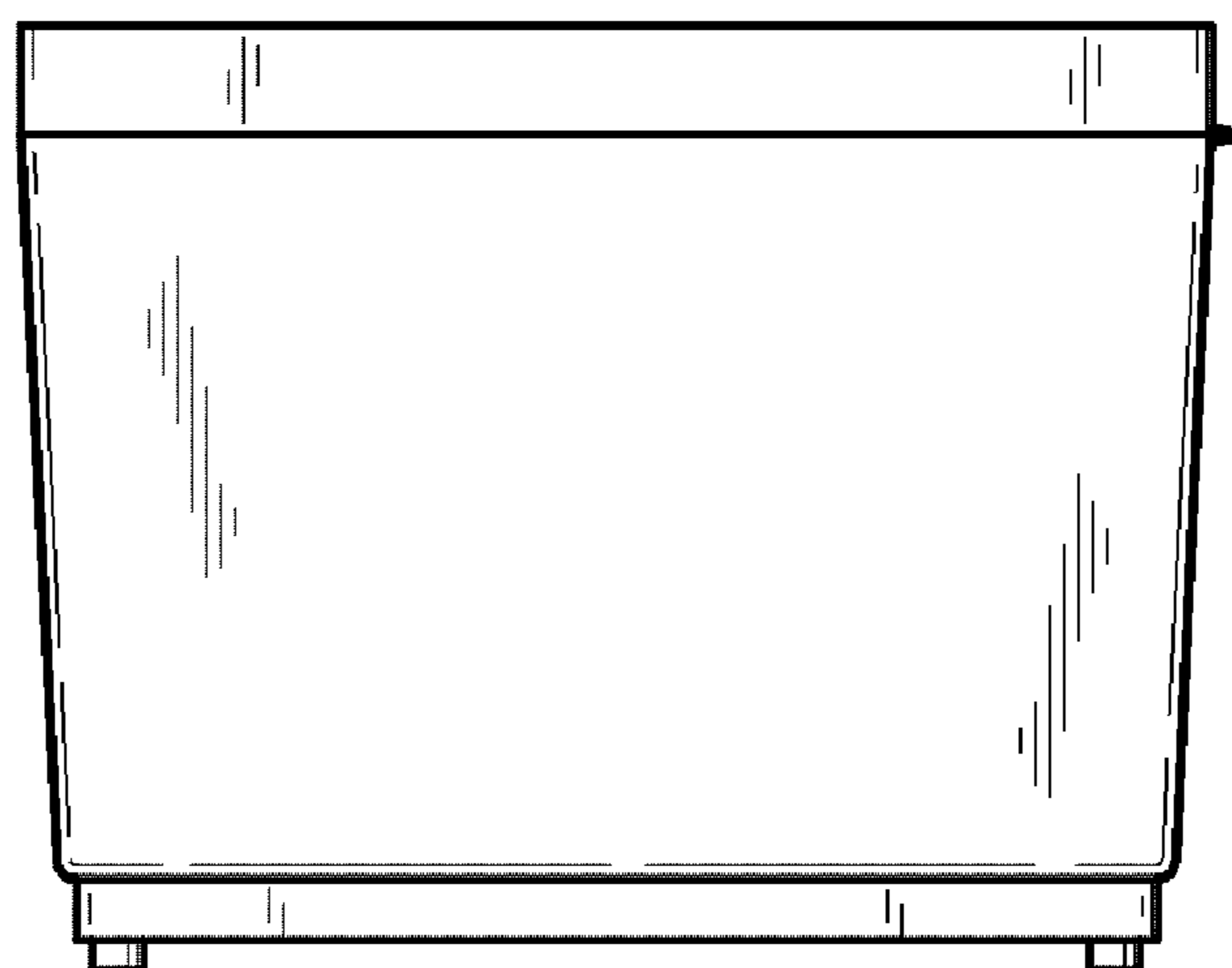

FIG. 4

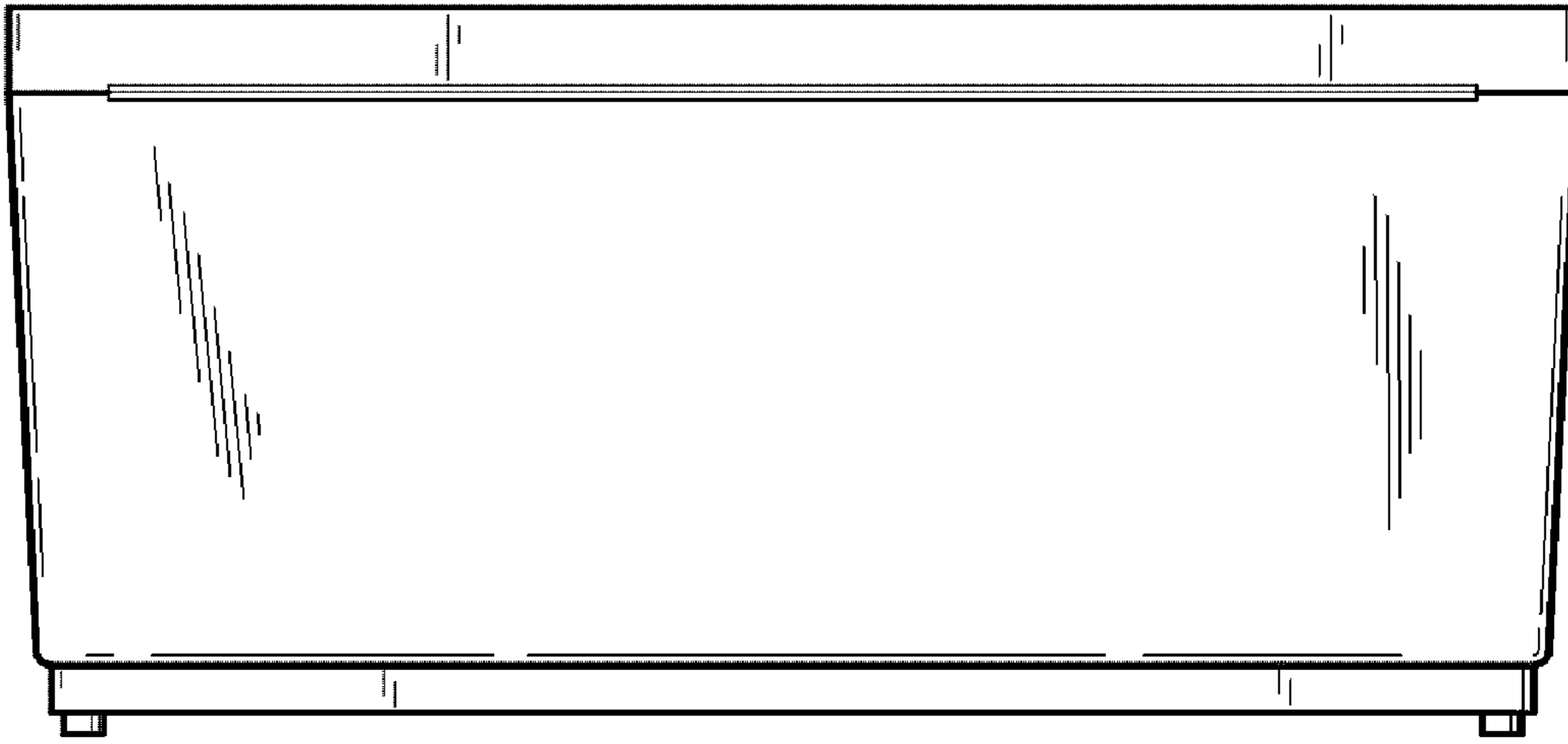

FIG. 5

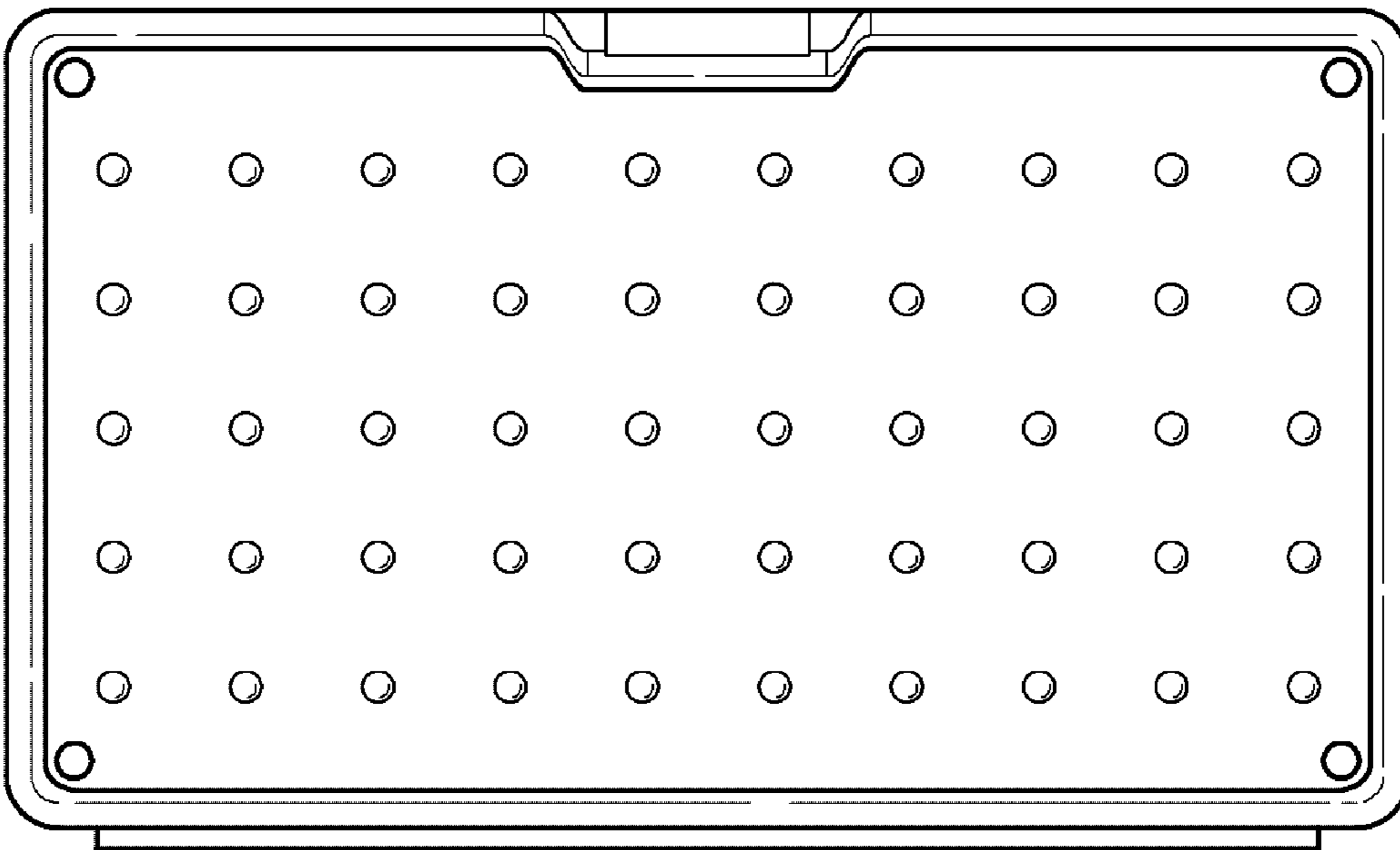

FIG. 6

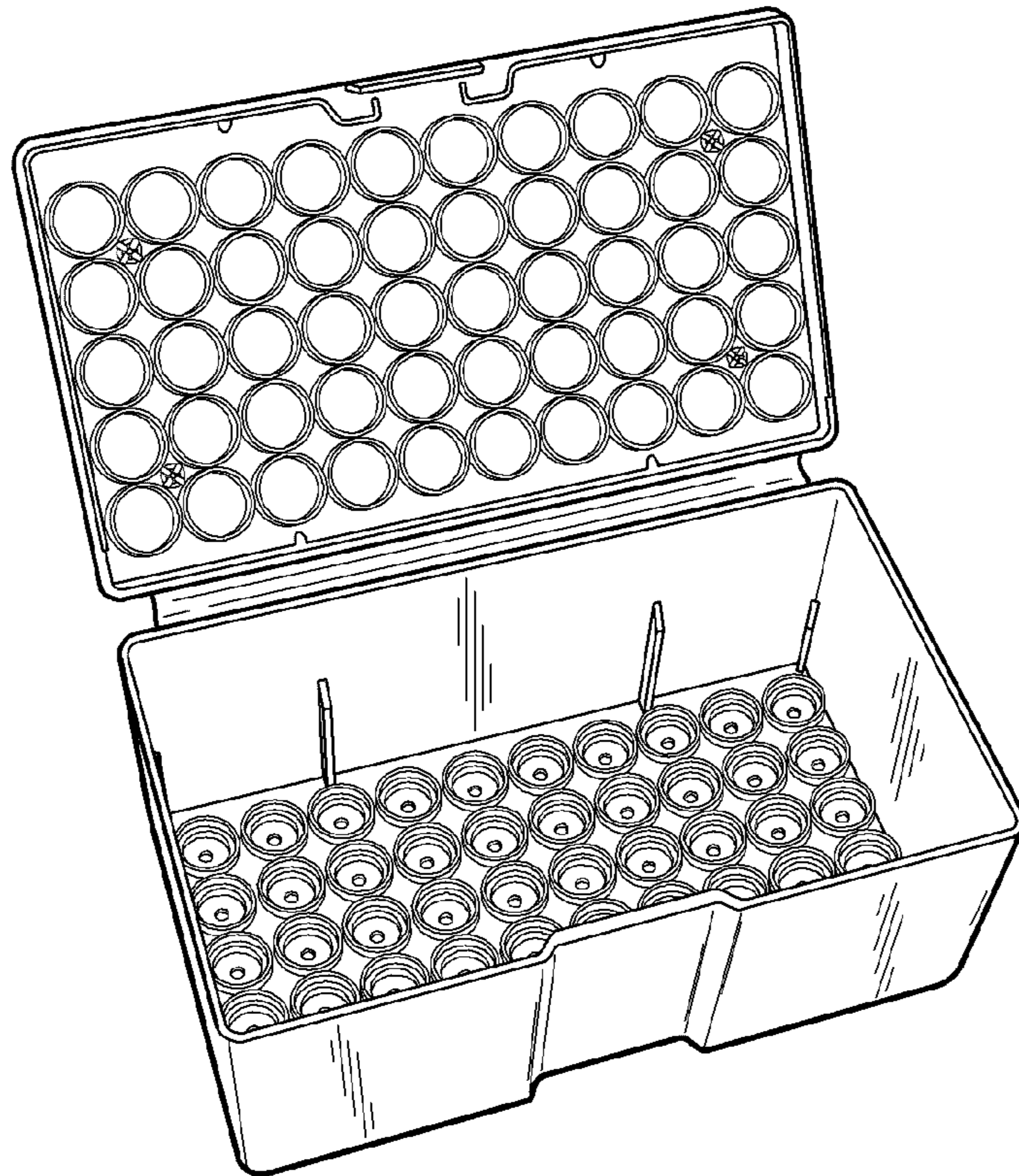

FIG. 7

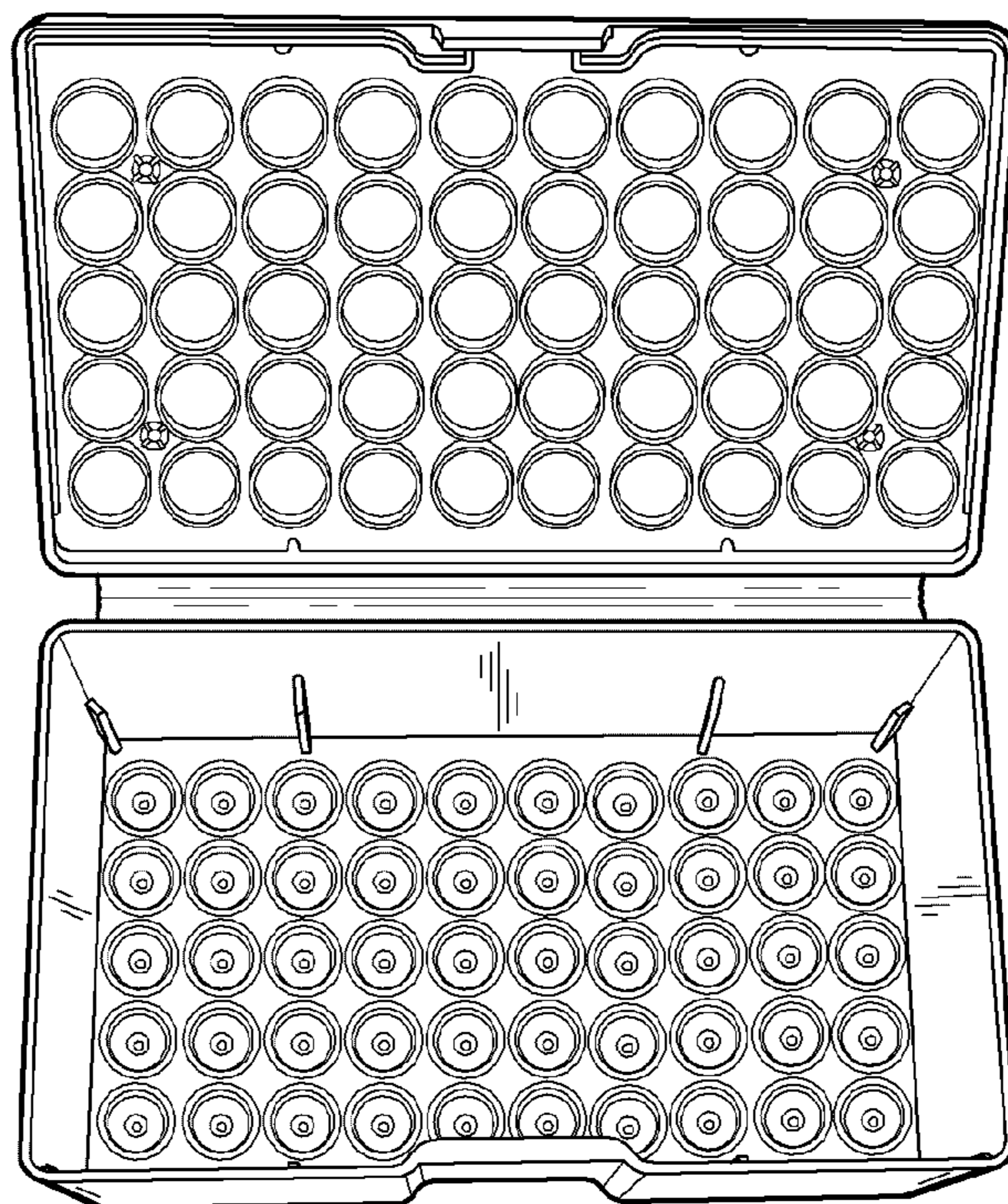

FIG. 8

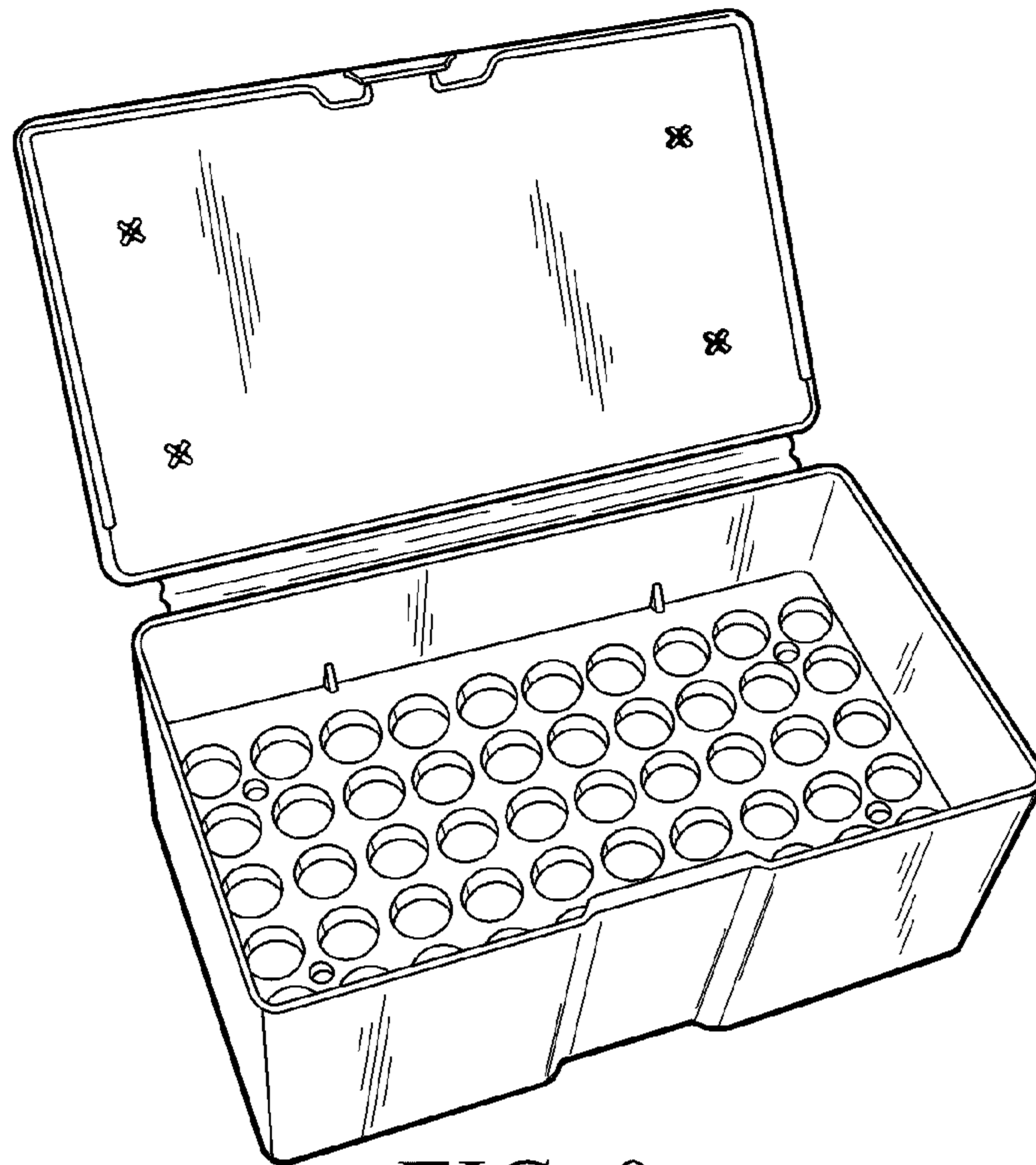

FIG. 9

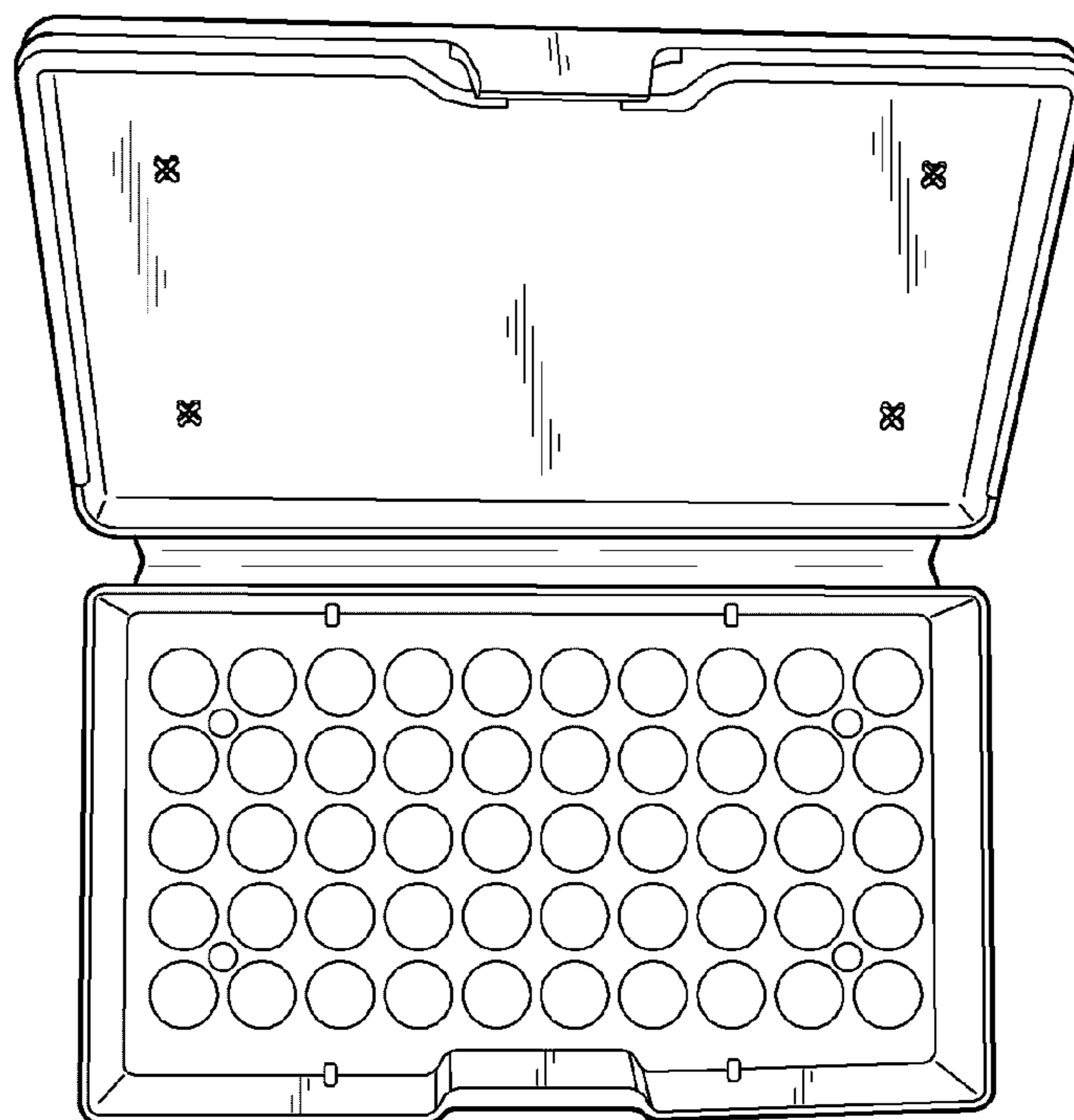

FIG. 10

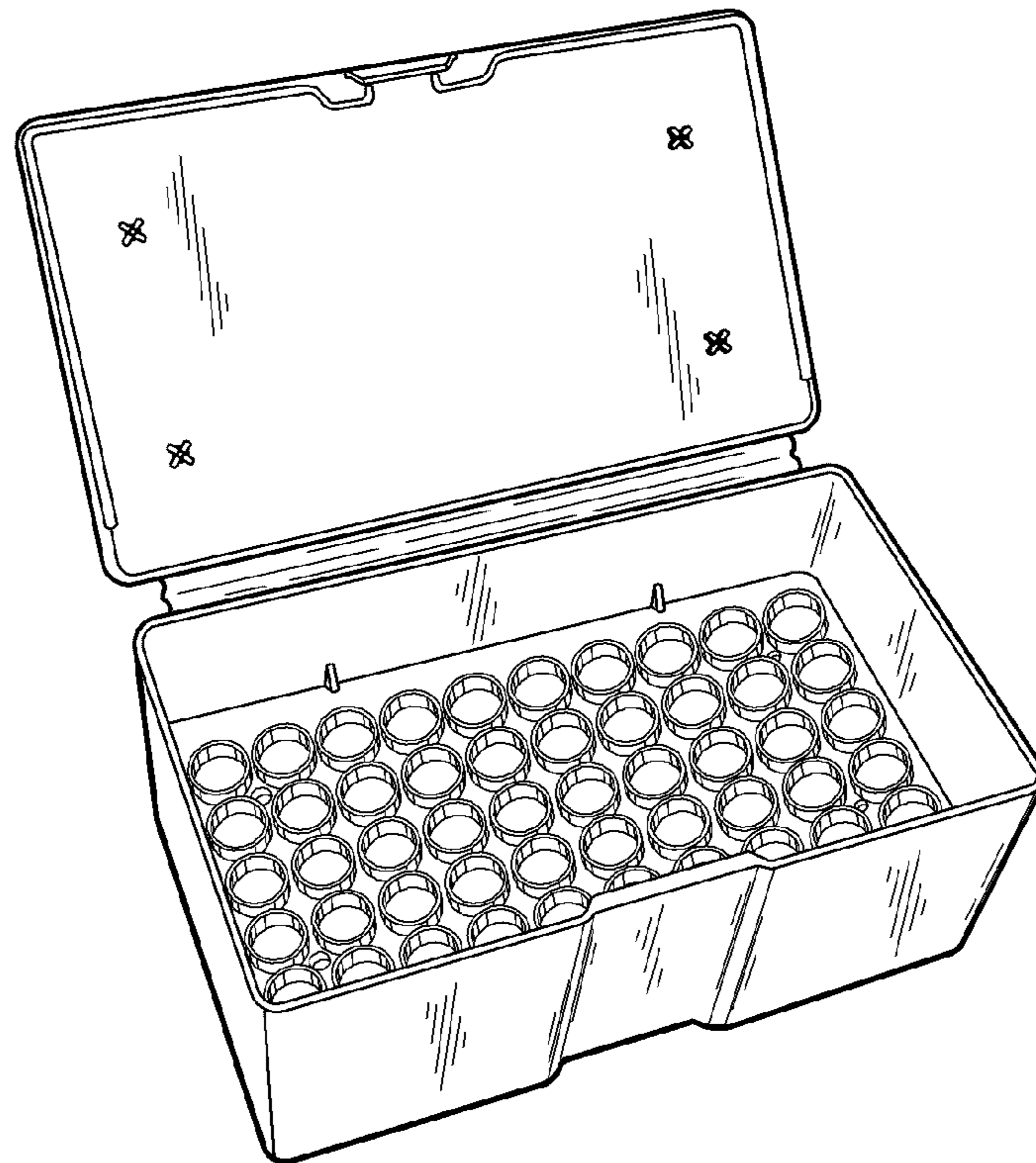

FIG. 11

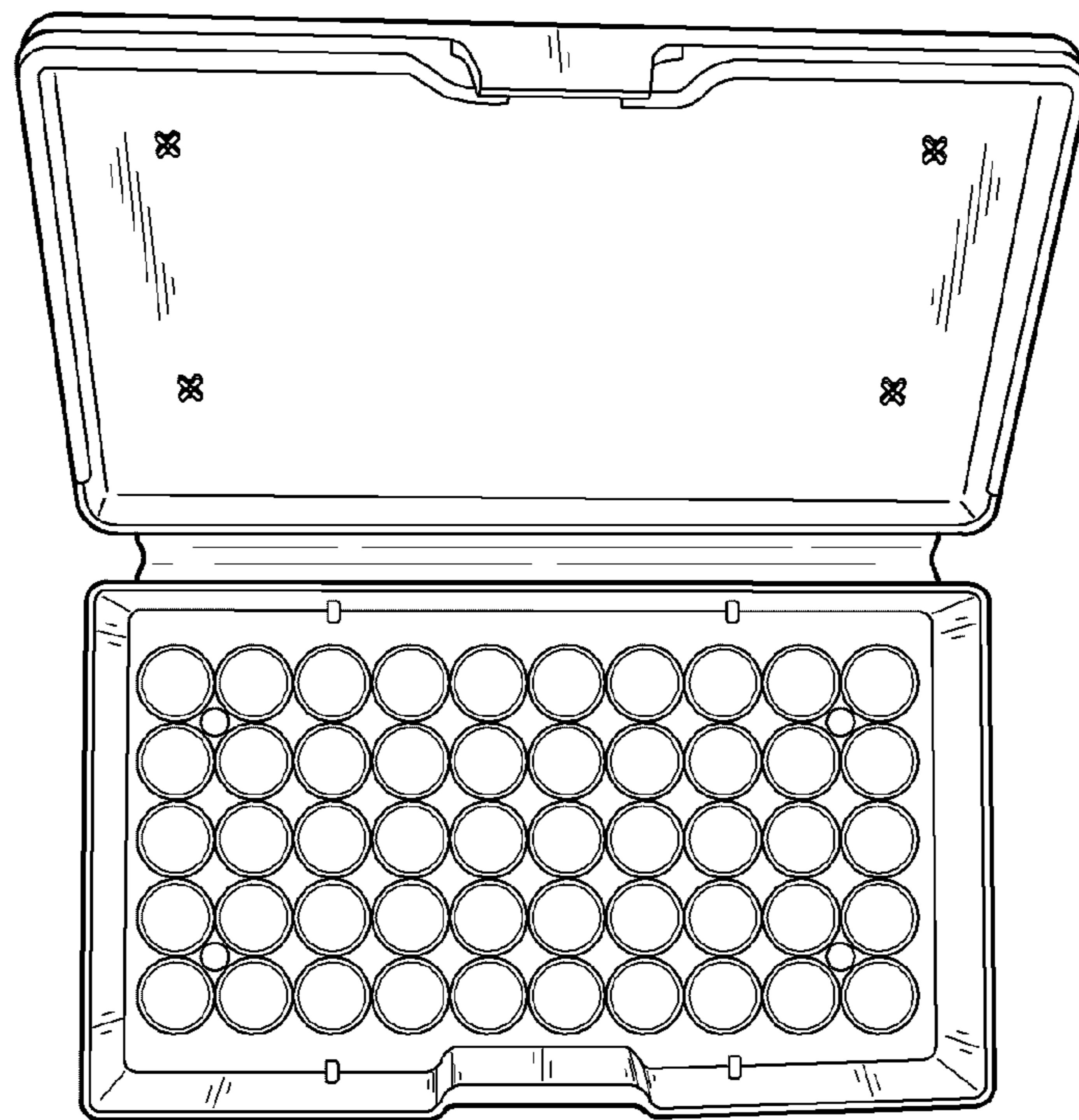

FIG. 12