



US00D644389S

(12) **United States Design Patent**
Roberts et al.

(10) **Patent No.:** **US D644,389 S**

(45) **Date of Patent:** **** *Aug. 30, 2011**

(54) **COMPOST COLLECTION BIN**

(76) Inventors: **Colin Roberts**, Ottawa (CA); **Robert D. Watters**, Ottawa (CA); **Romeo Graham**, Chelsea (CA); **Michael G. Sirois**, Ottawa (CA)

(*) Notice: This patent is subject to a terminal disclaimer.

(**) Term: **14 Years**

(21) Appl. No.: **29/332,126**

(22) Filed: **Feb. 9, 2009**

(51) **LOC (9) Cl.** **09-09**

(52) **U.S. Cl.** **D34/7**

(58) **Field of Classification Search** D34/1-11;
220/908-911, 500, 553; 232/43.2

See application file for complete search history.

(56) **References Cited**

U.S. PATENT DOCUMENTS

1,170,797 A * 2/1916 Burroughs 220/263
1,441,040 A * 1/1923 Stephenson 220/480
D327,346 S * 6/1992 Tamayo D34/1

D329,930 S * 9/1992 Delmerico et al. D34/7
D348,964 S * 7/1994 Roy et al. D34/7
D351,701 S * 10/1994 Sawatsky D34/7
D386,904 S * 12/1997 Bradshaw, Jr. D3/273
6,053,354 A * 4/2000 Niemeyer 220/819
D439,717 S * 3/2001 Konieczny D34/1

* cited by examiner

Primary Examiner — Cynthia E Ramirez

(74) *Attorney, Agent, or Firm* — Gordon Thomson

(57) **CLAIM**

The ornamental design for a compost collection bin, as shown and described.

DESCRIPTION

FIG. 1 is a front view of a compost collection bin with the lid closed showing our new design;
FIG. 2 is a side view thereof;
FIG. 3 is a top plan view thereof;
FIG. 4 is a side view with the lid open;
FIG. 5 is a top perspective view with the lid closed;
FIG. 6 is a top front perspective view with the lid open;
FIG. 7 is a top rear perspective view thereof; and,
FIG. 8 is a bottom plan view thereof.

1 Claim, 8 Drawing Sheets

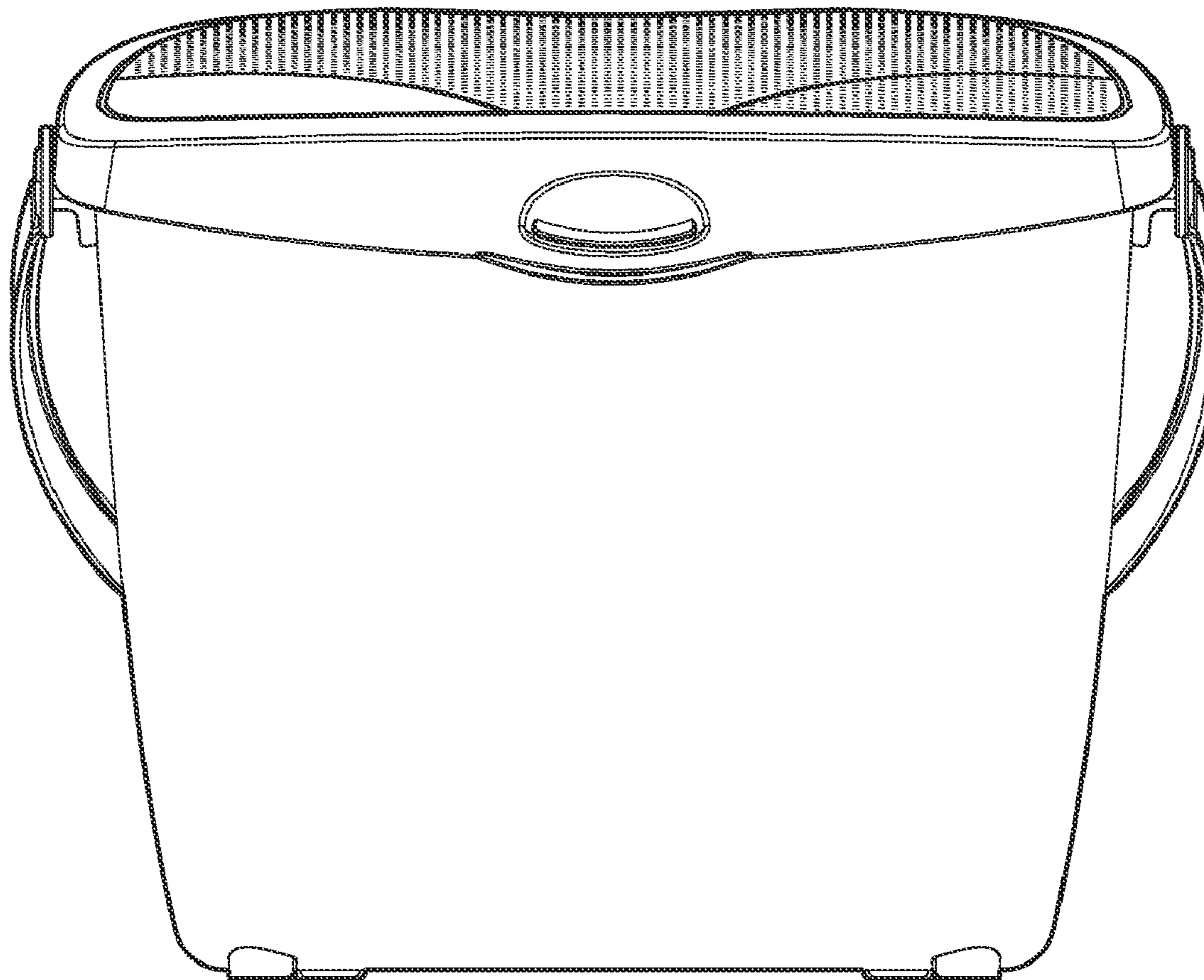

FIGURE 1

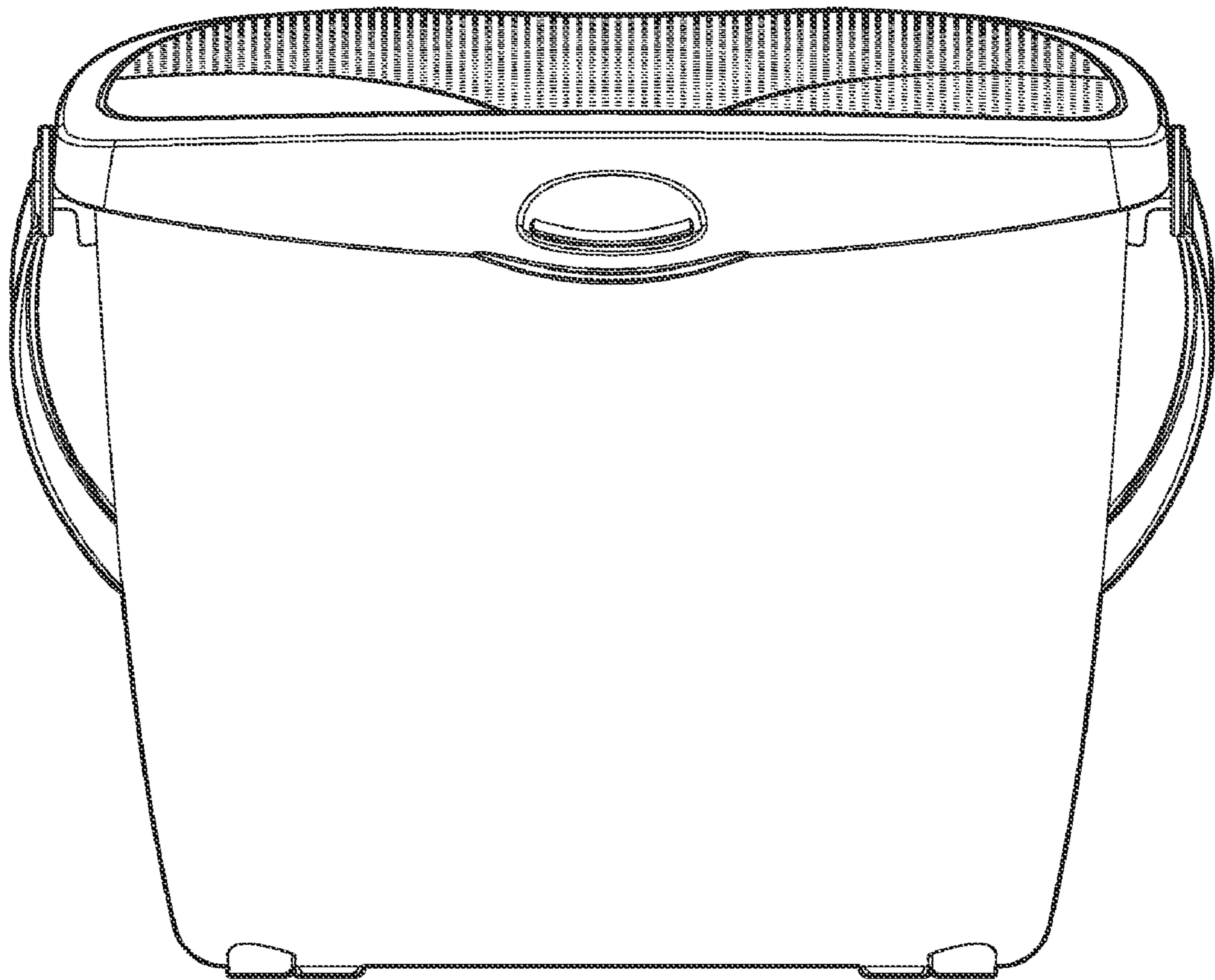

FIGURE 2

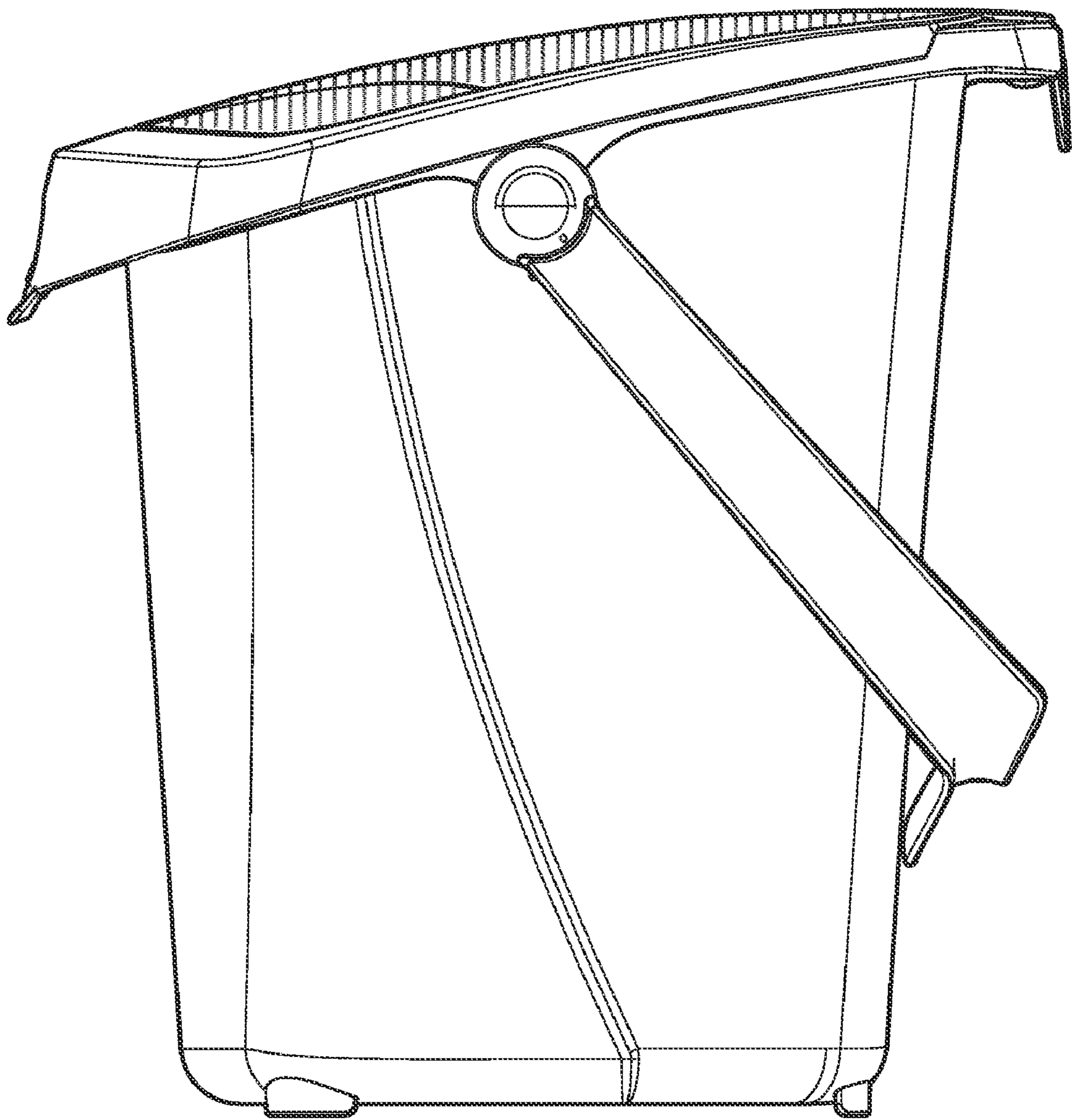

FIGURE 3

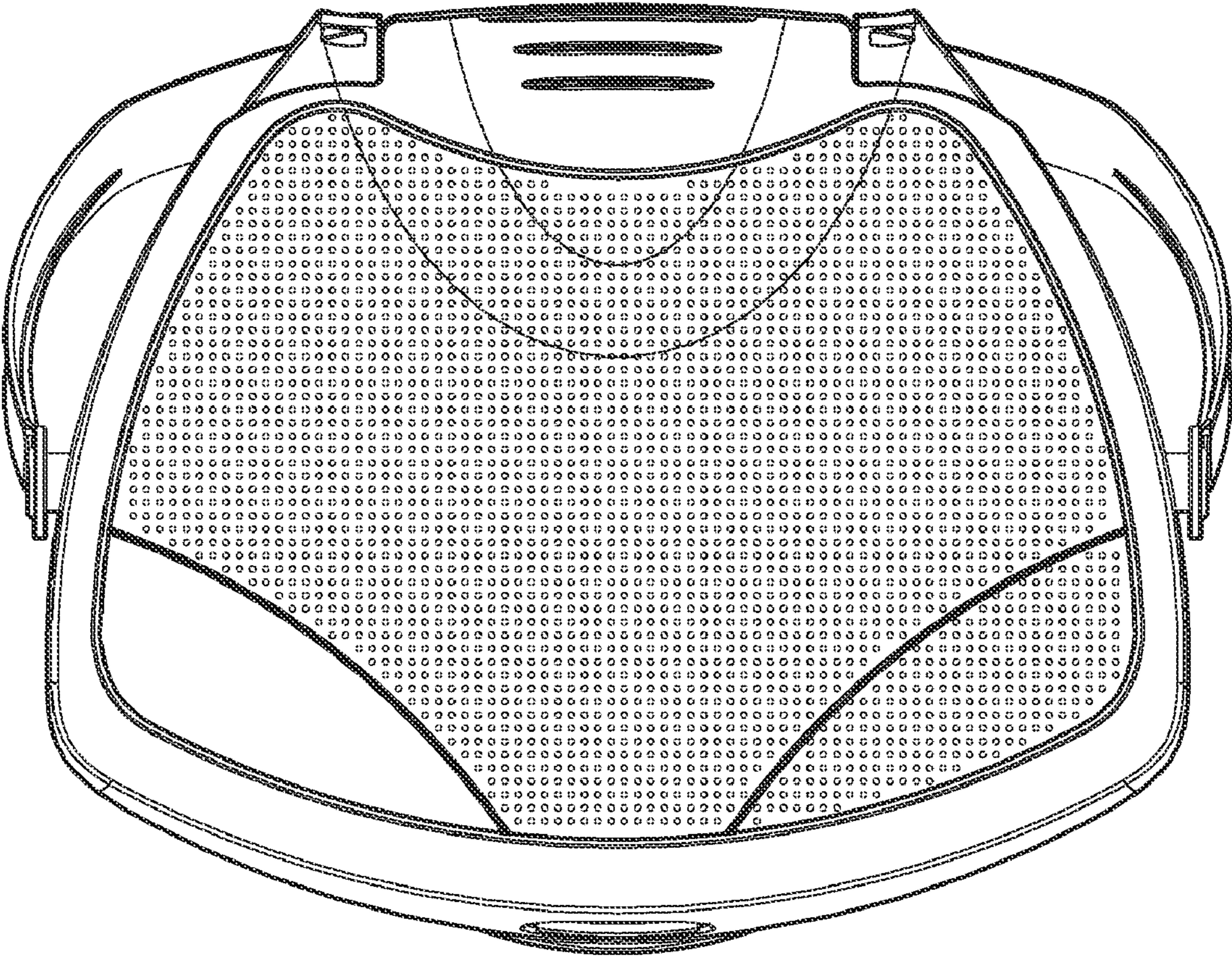

FIGURE 4

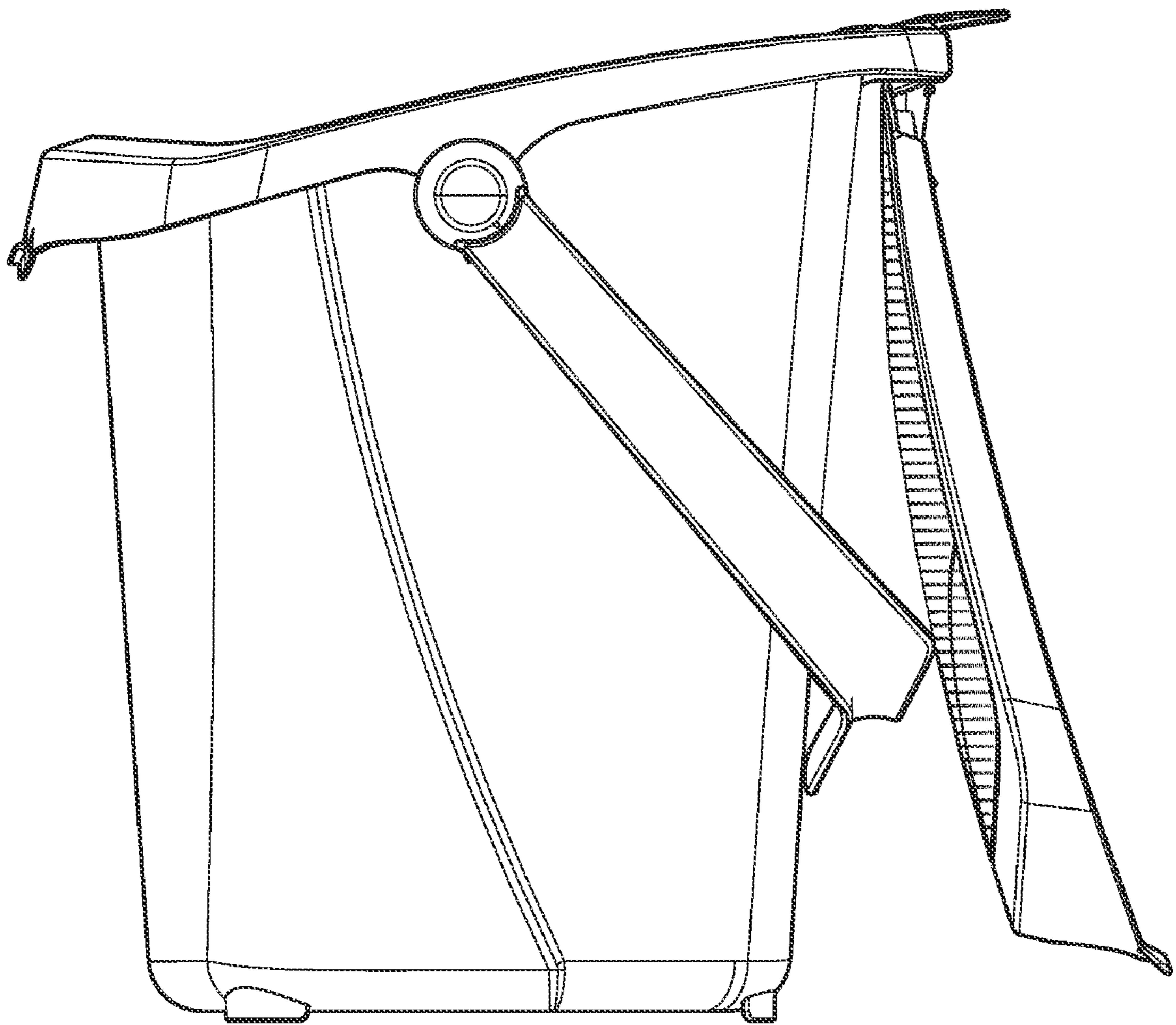

FIGURE 5

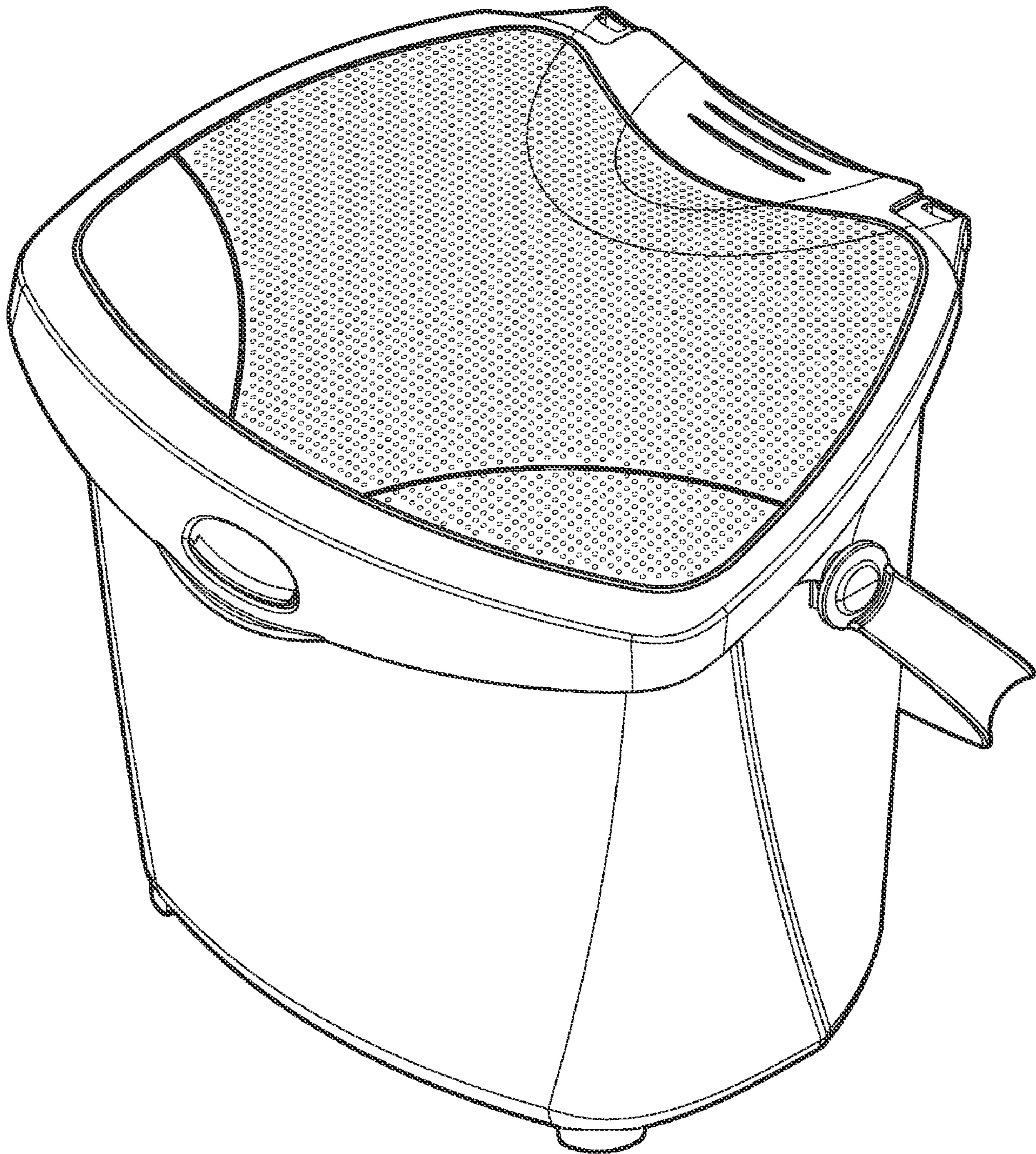

FIGURE 6

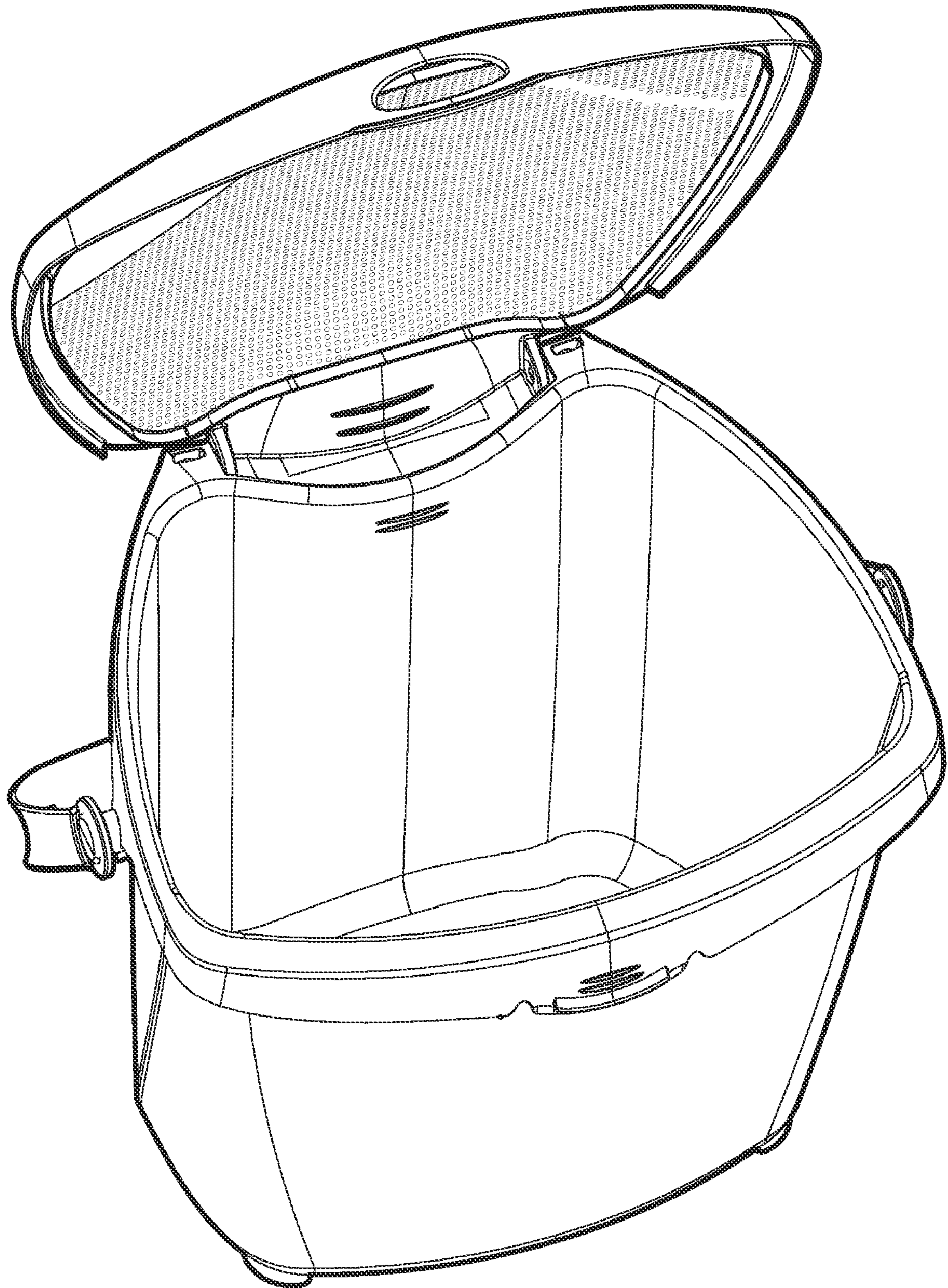

FIGURE 7

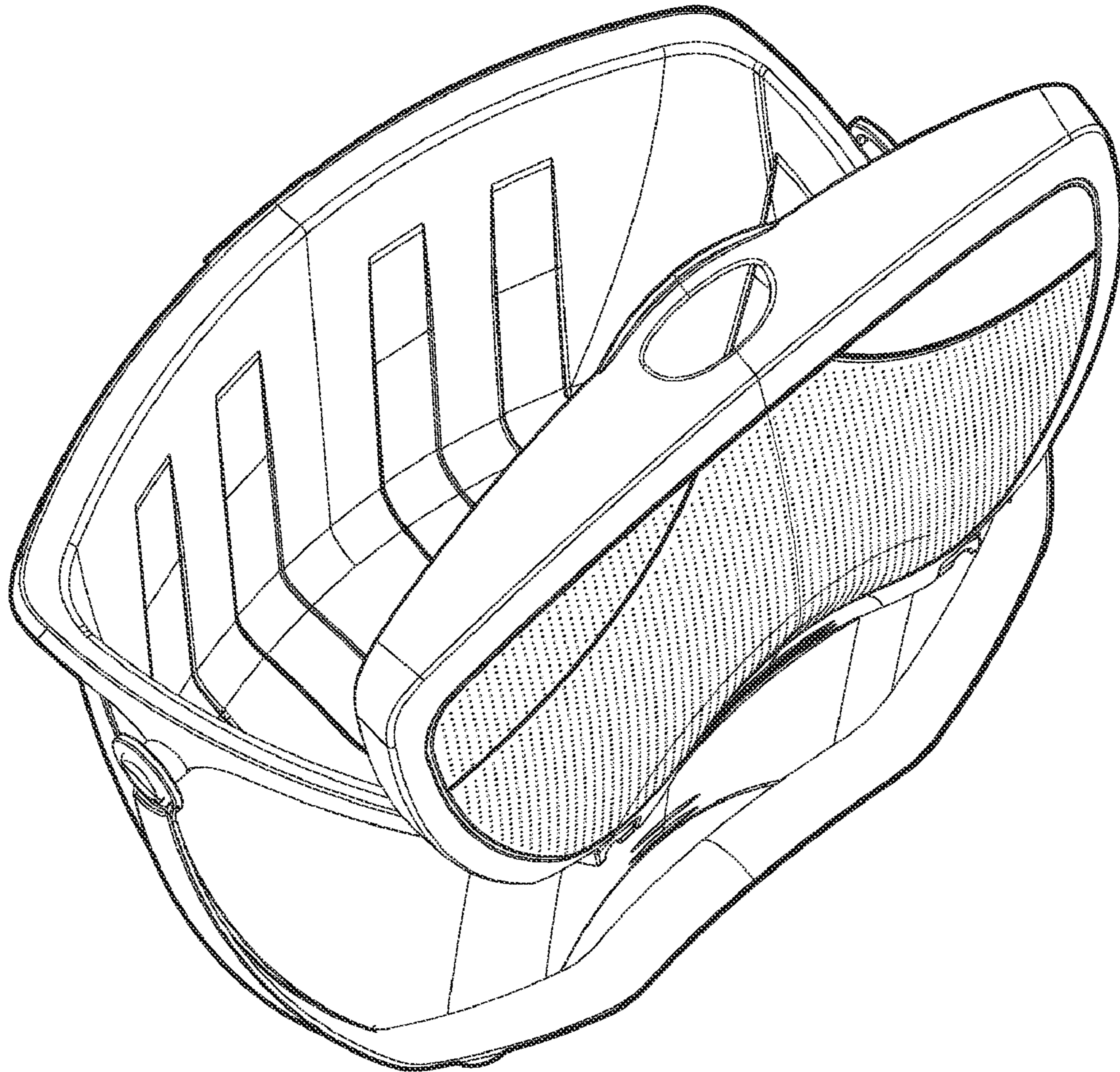

FIGURE 8

