



US00D644368S

(12) **United States Design Patent**
Fu

(10) **Patent No.:** **US D644,368 S**

(45) **Date of Patent:** **** Aug. 30, 2011**

(54) **MAGNIFYING LAMP**

(76) **Inventor:** **Bai Nian Fu, Yuyao (CN)**

(**) **Term:** **14 Years**

(21) **Appl. No.:** **29/378,658**

(22) **Filed:** **Nov. 8, 2010**

(51) **LOC (9) Cl.** **26-05**

(52) **U.S. Cl.** **D26/65**

(58) **Field of Classification Search** D26/60-66,
D26/51, 106-109; D16/135; 362/410-414,
362/253, 402, 269, 270, 274, 277, 282, 285,
362/287, 288, 418, 419, 427, 401, 275, 278,
362/33; 359/800, 802, 822

See application file for complete search history.

(56) **References Cited**

U.S. PATENT DOCUMENTS

D276,940 S * 12/1984 Andersson D26/65
4,958,913 A * 9/1990 Schaffer 359/819
6,663,266 B2 * 12/2003 Huang 362/402

D597,238 S * 7/2009 Lu et al. D26/61
D597,239 S * 7/2009 Hodgson D26/65
D597,240 S * 7/2009 Hodgson D26/65

* cited by examiner

Primary Examiner — Susan M Lee

Assistant Examiner — Linda G. Brooks

(74) *Attorney, Agent, or Firm* — Jen-Feng Lee

(57) **CLAIM**

I claim the ornamental design for a magnifying lamp, as shown and described.

DESCRIPTION

FIG. 1 shows the perspective view of a magnifying lamp showing my new design,
FIG. 2 shows the front view thereof,
FIG. 3 shows the rear view thereof,
FIG. 4 shows the left side view thereof,
FIG. 5 shows the right side view thereof,
FIG. 6 shows the top plan view thereof; and,
FIG. 7 shows the bottom view thereof.

1 Claim, 7 Drawing Sheets

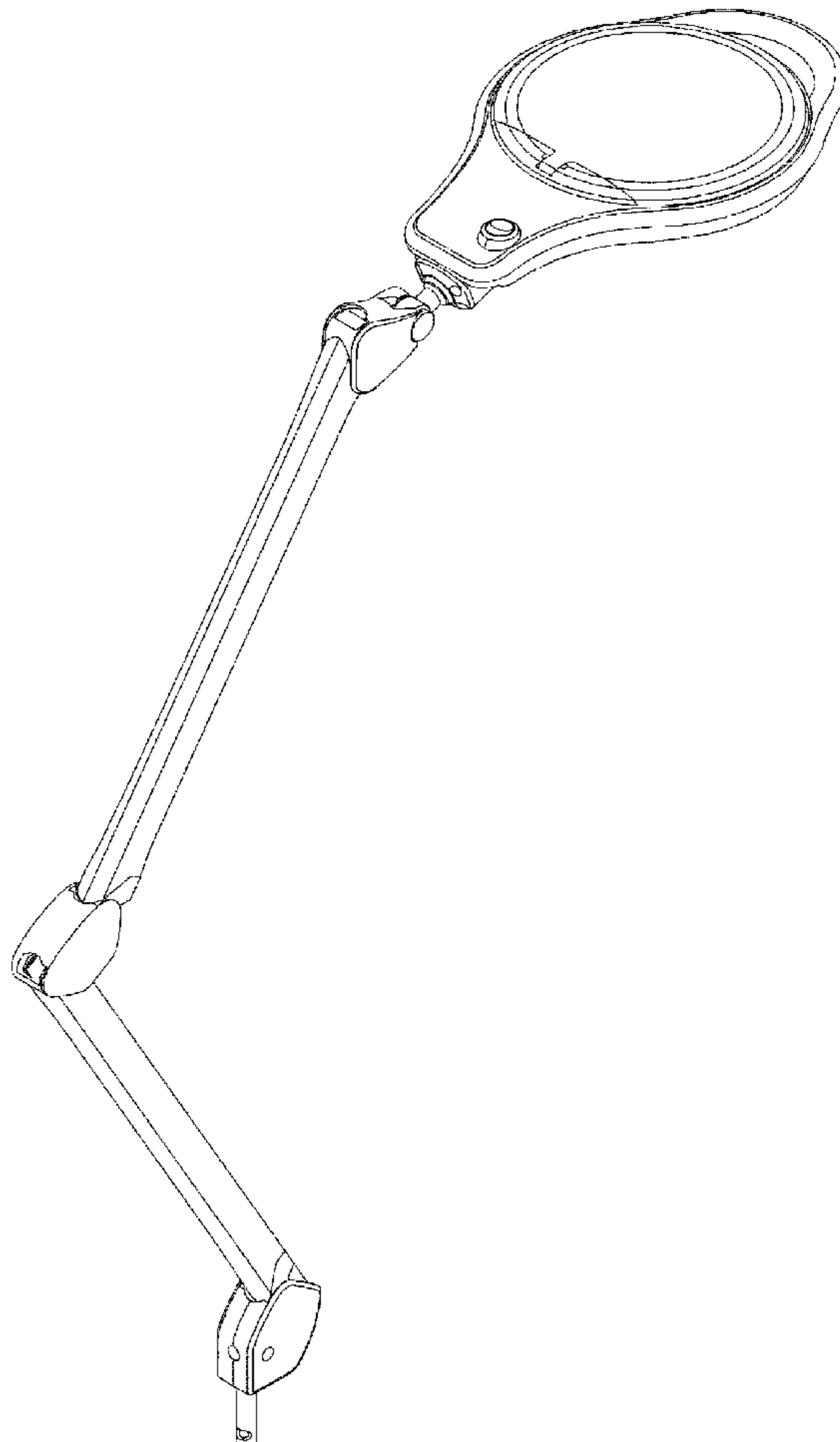

FIGURE 1

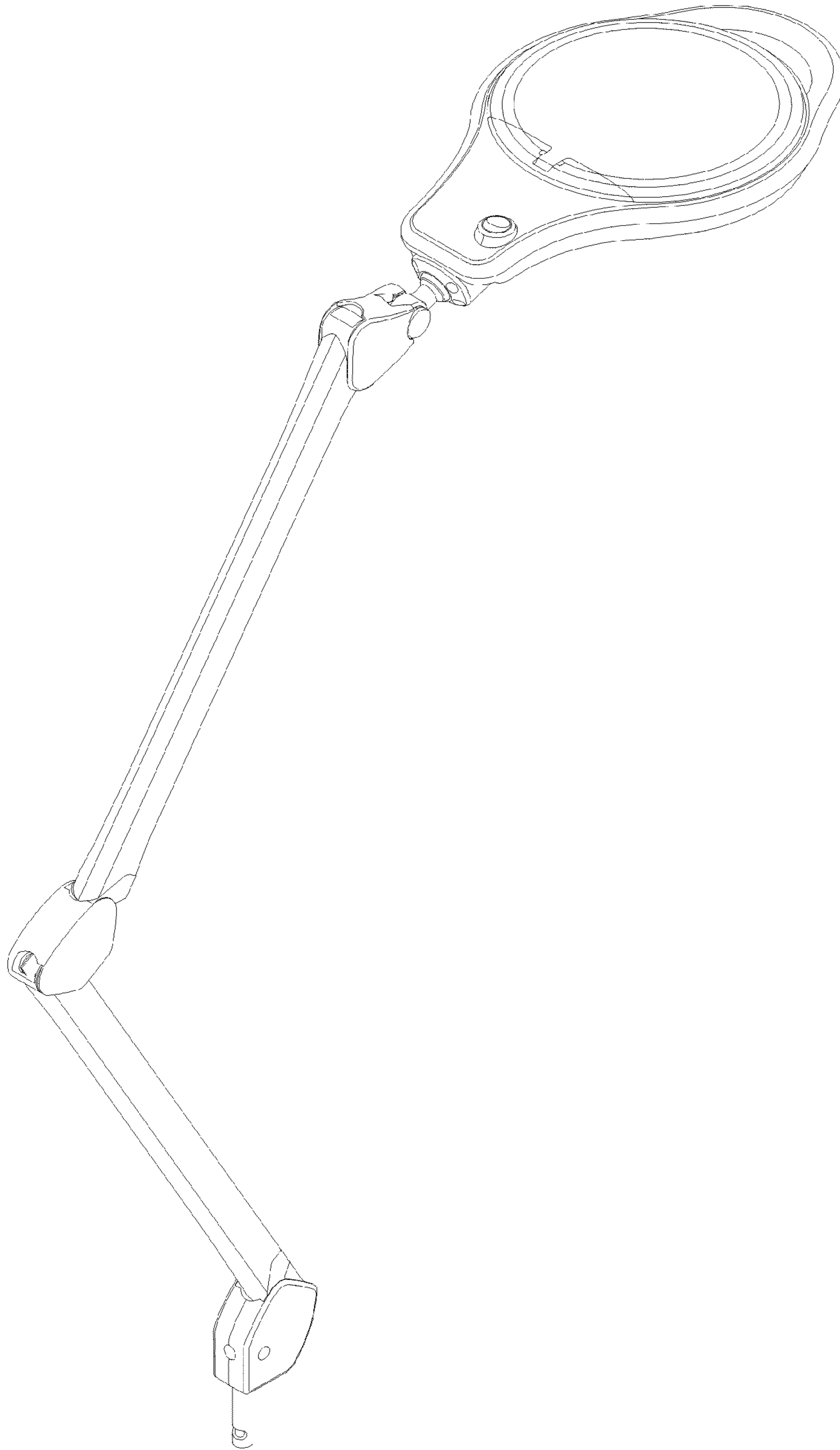

FIGURE 2

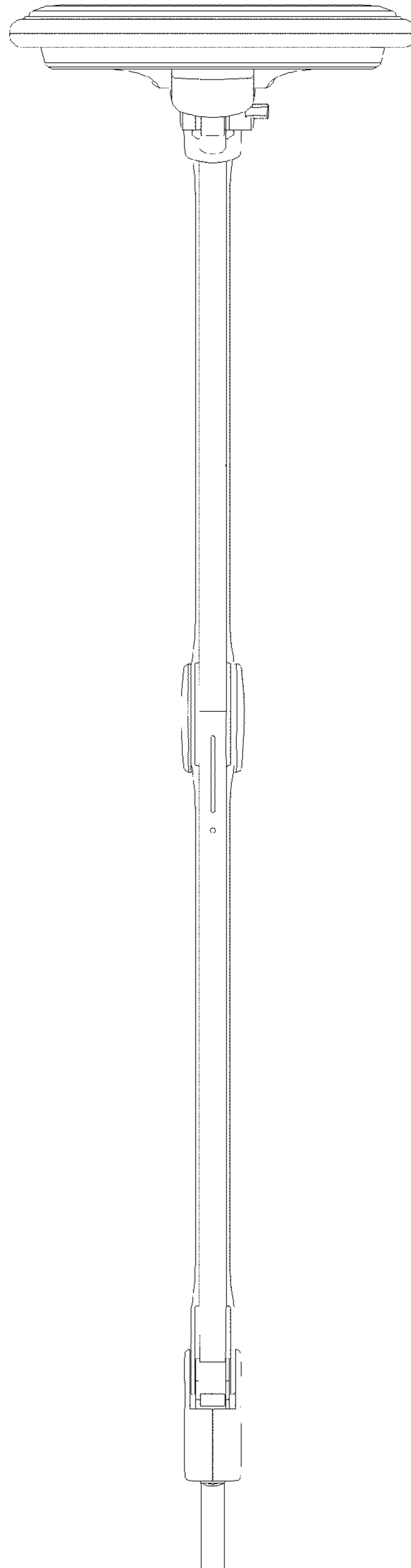

FIGURE 3

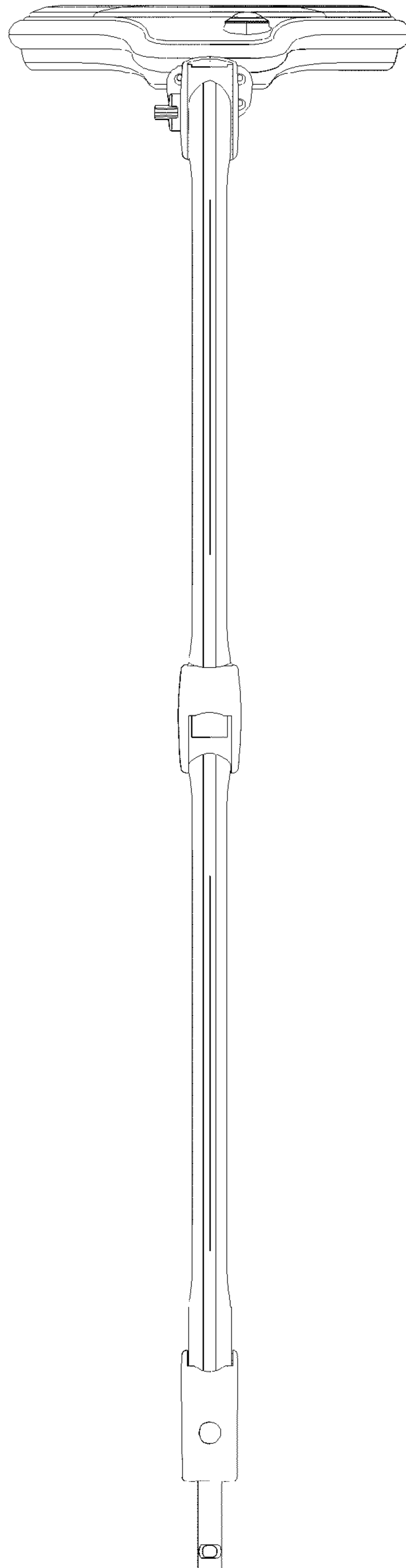

FIGURE 4

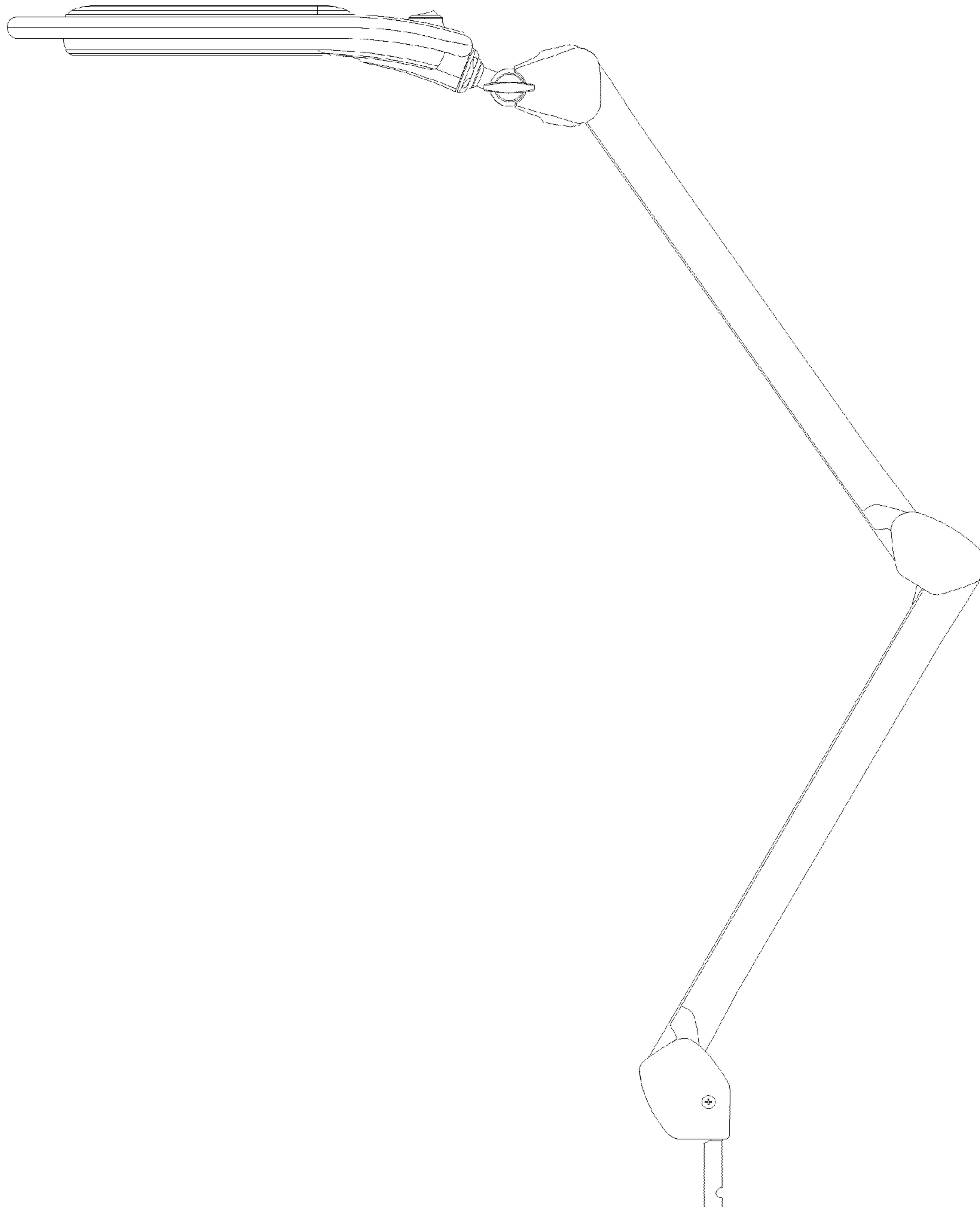

FIGURE 5

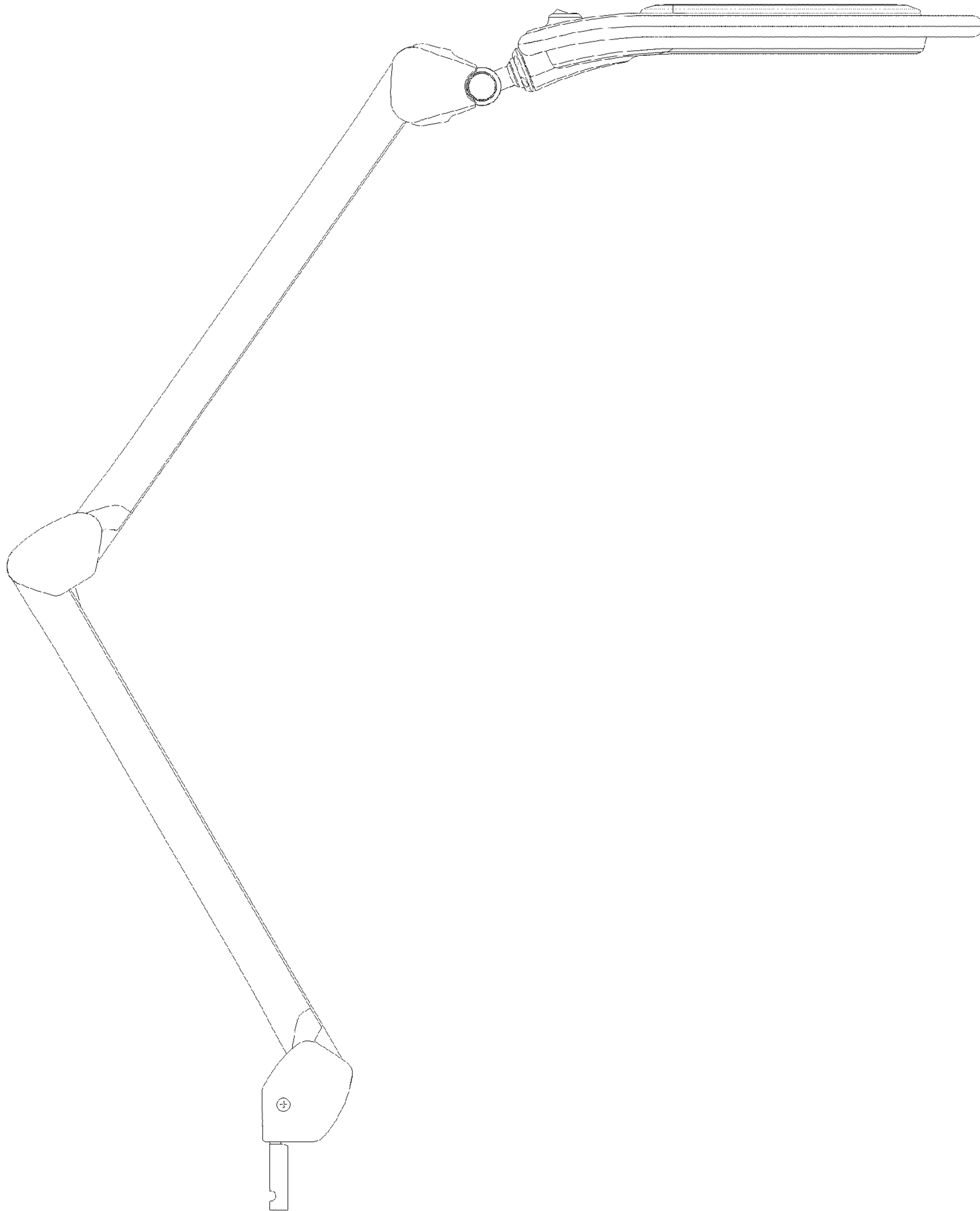

FIGURE 6

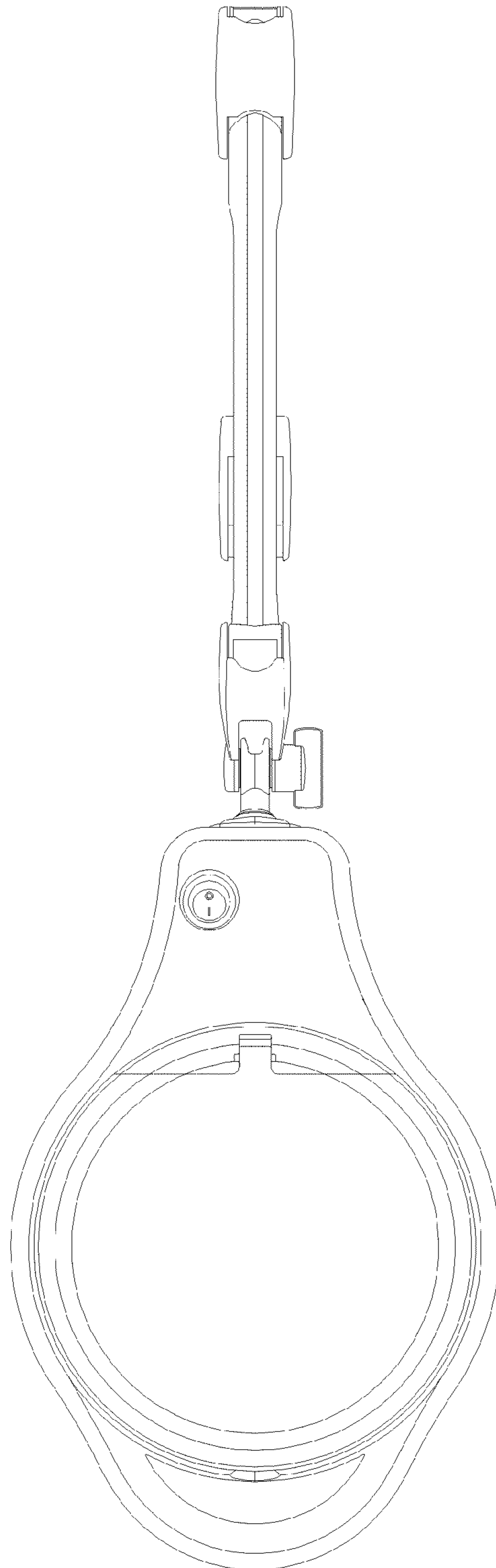

FIGURE 7

