



US00D644146S

(12) **United States Design Patent**  
**Ganassi et al.**

(10) **Patent No.:** **US D644,146 S**

(45) **Date of Patent:** **\*\* Aug. 30, 2011**

(54) **RACE CAR**

(75) Inventors: **Chip Ganassi**, Pittsburgh, PA (US);  
**Benjamin Bowlby**, Zionsville, IN (US);  
**Zack Eakin**, Pittsboro, IN (US); **James Hamilton**, Zionsville, IN (US)

(73) Assignee: **Delta Wing, LLC**, Indianapolis, IN (US)

(\*\*) Term: **14 Years**

(21) Appl. No.: **29/381,295**

(22) Filed: **Dec. 17, 2010**

**Related U.S. Application Data**

(62) Division of application No. 29/345,558, filed on Oct. 19, 2009, now Pat. No. Des. 631,396.

(51) **LOC (9) Cl.** ..... **12-08**

(52) **U.S. Cl.** ..... **D12/88**

(58) **Field of Classification Search** ..... D12/86,  
D12/90-92, 88, 85; D21/424, 433, 434;  
296/181.1, 181.5

See application file for complete search history.

(56) **References Cited**

**U.S. PATENT DOCUMENTS**

D268,920 S \* 5/1983 Bragdon ..... D12/86  
D269,505 S \* 6/1983 Gordon ..... D12/85  
D274,398 S \* 6/1984 Keyes ..... D12/85  
D362,208 S \* 9/1995 Gangnant ..... D12/86

D576,918 S \* 9/2008 Taylor et al. .... D12/88  
D577,314 S \* 9/2008 Dockery ..... D12/88  
D610,949 S \* 3/2010 Tombazis ..... D12/88  
D631,396 S \* 1/2011 Ganassi et al. .... D12/88

\* cited by examiner

*Primary Examiner* — Melody N Brown

(74) *Attorney, Agent, or Firm* — Bose McKinney & Evans LLP

(57) **CLAIM**

The ornamental design of a race car, as shown and described.

**DESCRIPTION**

FIG. 1 is a perspective view of a race car showing our new design;

FIG. 2 is a side elevational view thereof;

FIG. 3 is an opposite side elevational view thereof;

FIG. 4 is a top plan view thereof;

FIG. 5 is a bottom plan view thereof;

FIG. 6 is a front elevational view thereof;

FIG. 7 is a rear elevational view thereof;

FIG. 8 is a perspective view of a race car showing second embodiment of our new design;

FIG. 9 is a side elevational view of FIG. 8;

FIG. 10 is an opposite side elevational view of FIG. 8;

FIG. 11 is a top plan view of FIG. 8;

FIG. 12 is a bottom plan view of FIG. 8;

FIG. 13 is a front elevational view of FIG. 8; and,

FIG. 14 is a rear elevational view of FIG. 8.

The wheels shown in broken lines throughout the drawing specification are shown for illustrative purposes only and form no part of the claimed design.

**1 Claim, 12 Drawing Sheets**

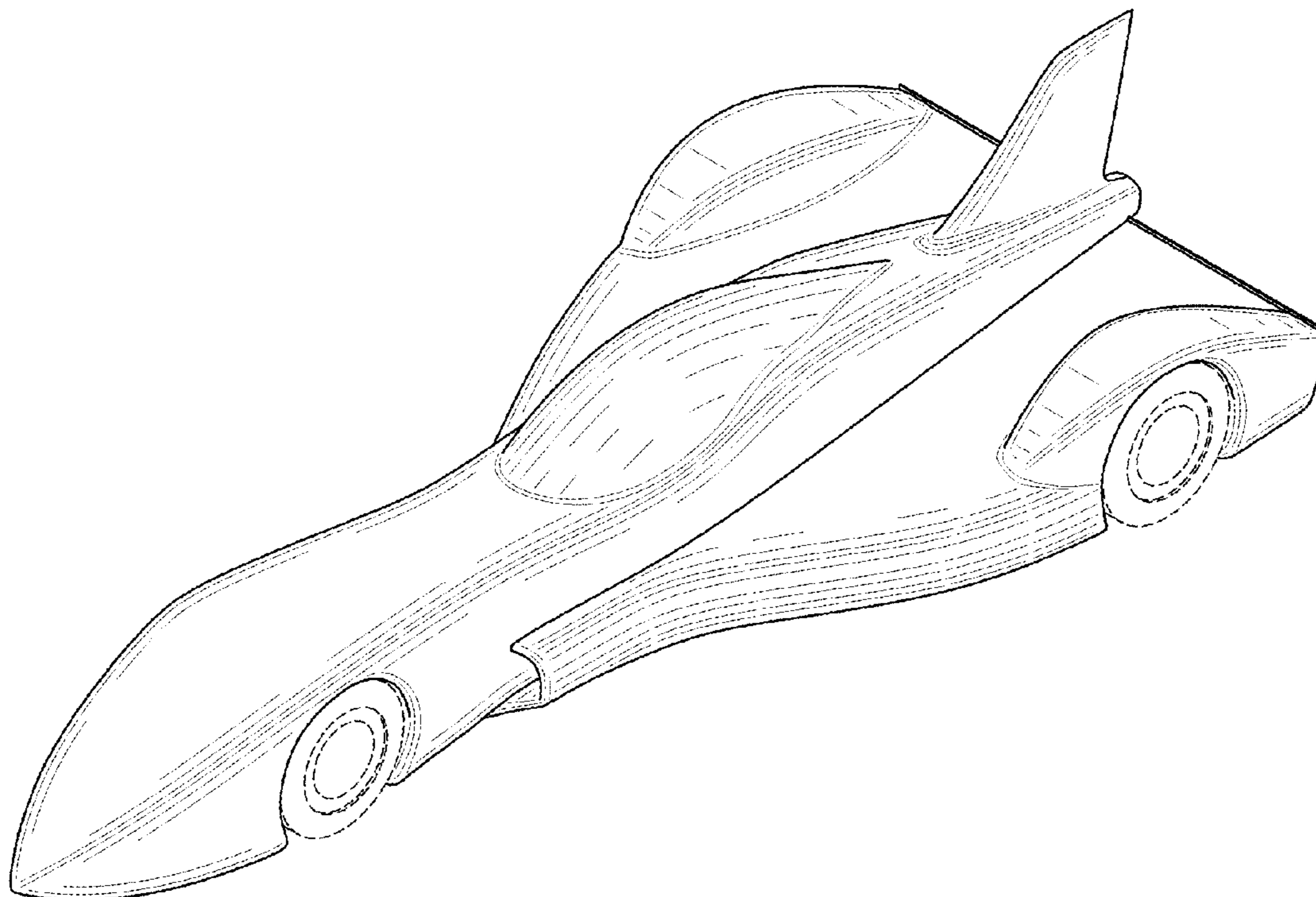

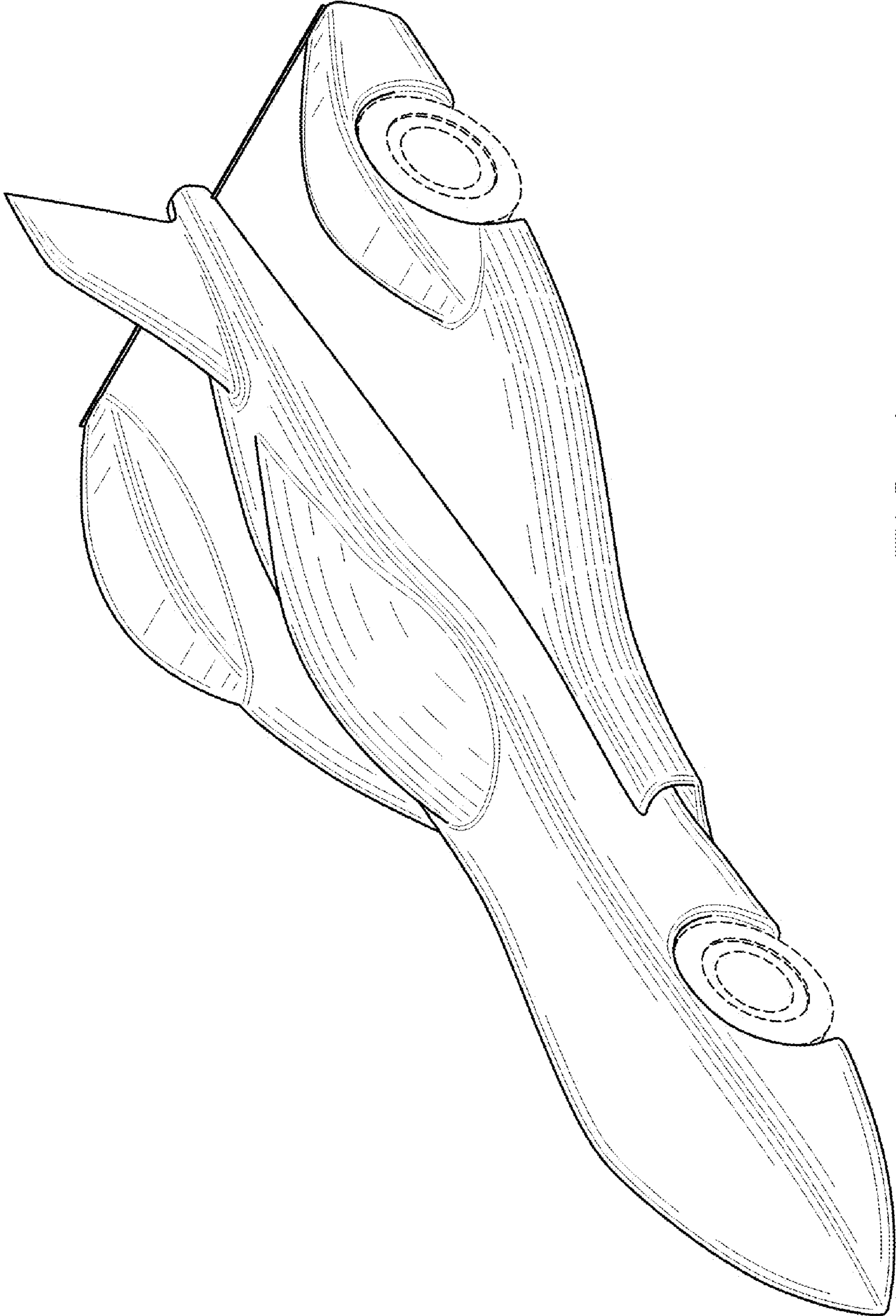

FIG. 1

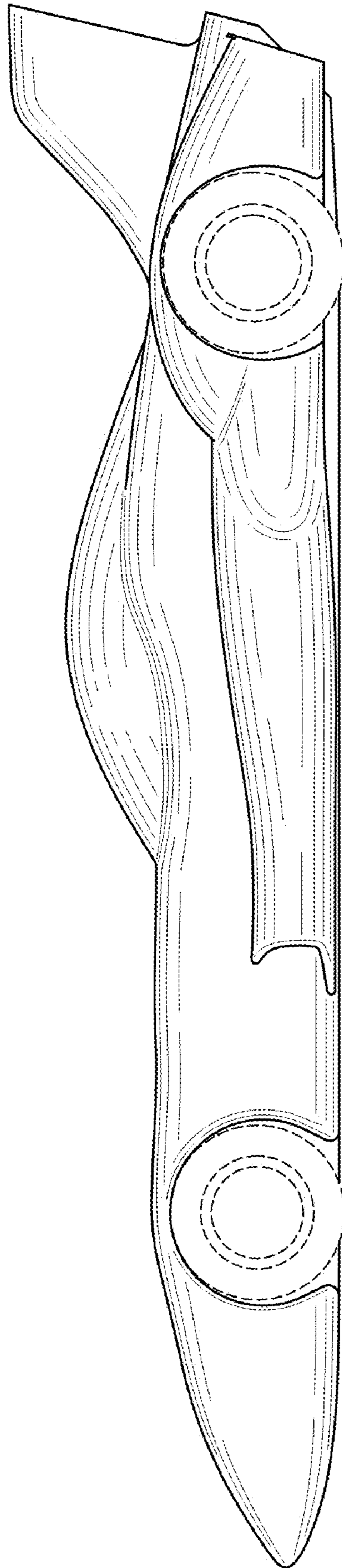

FIG. 2



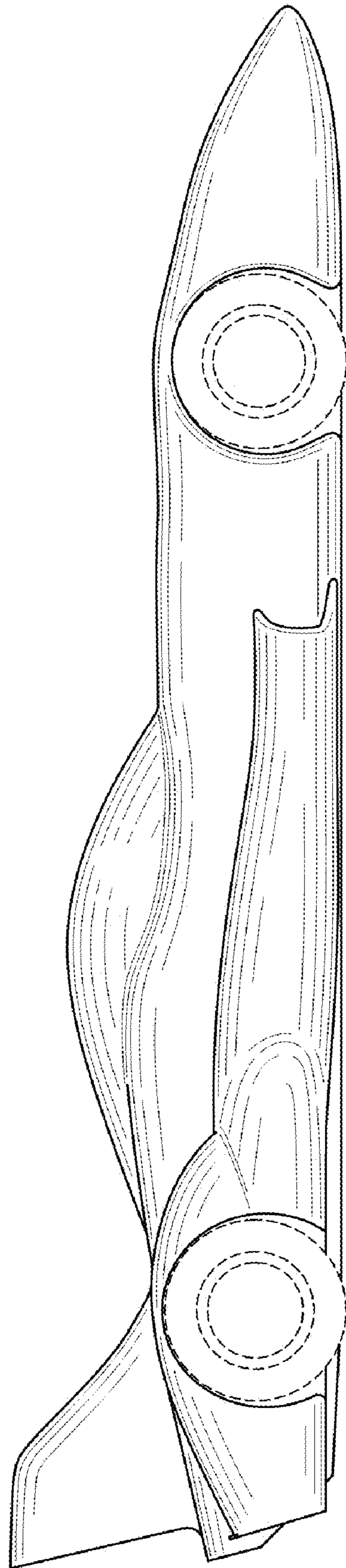

FIG. 3

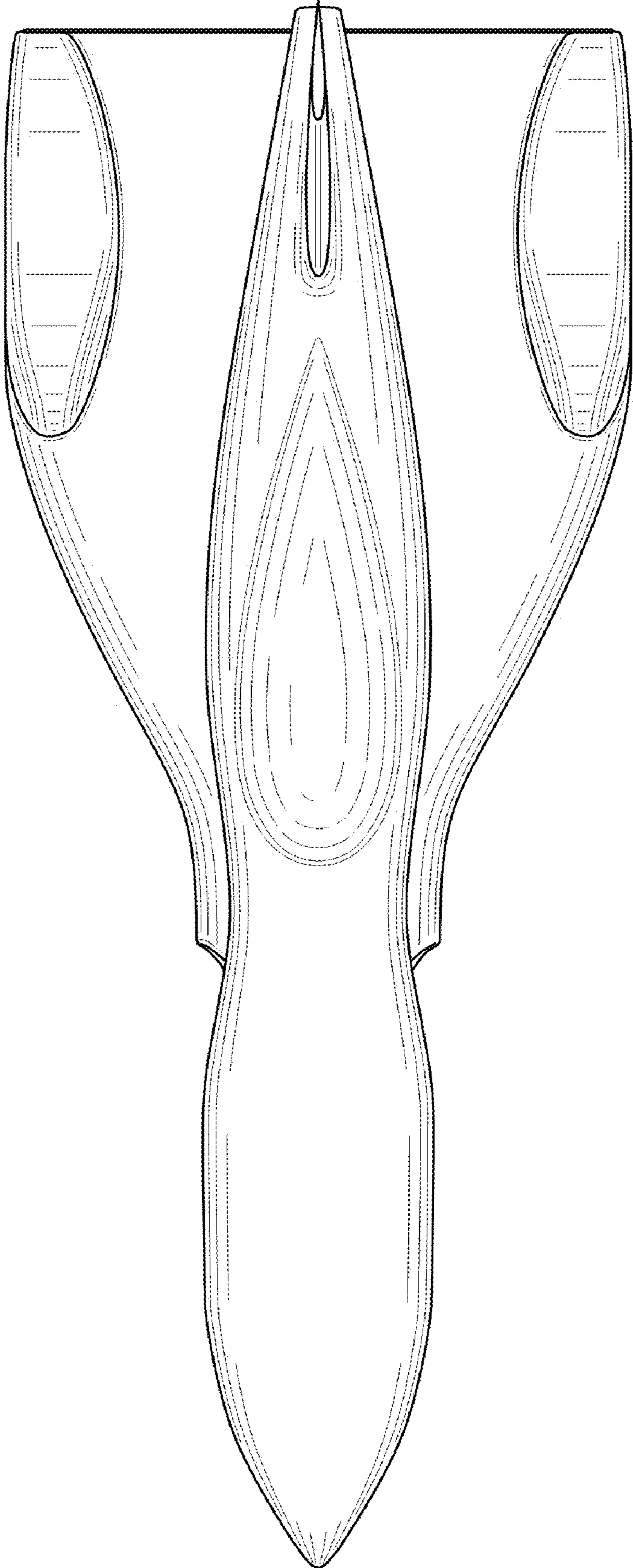

FIG. 4

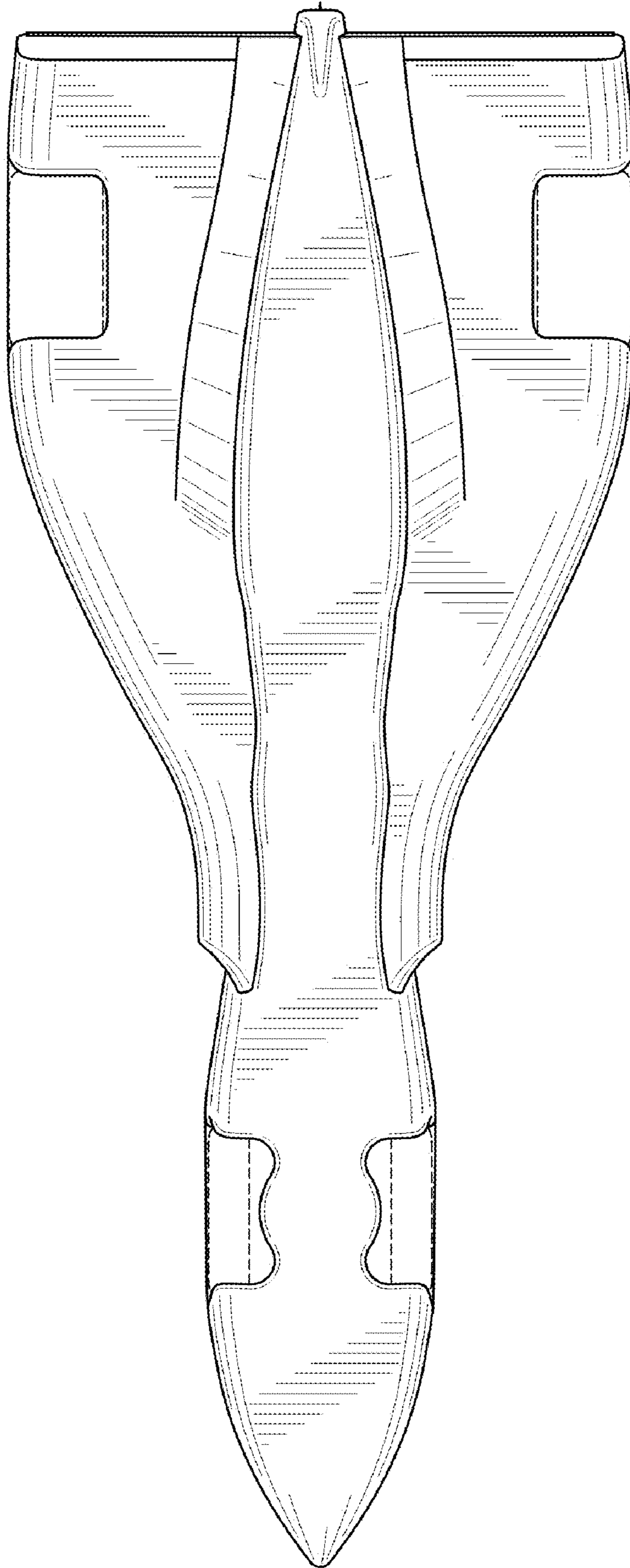

FIG. 5

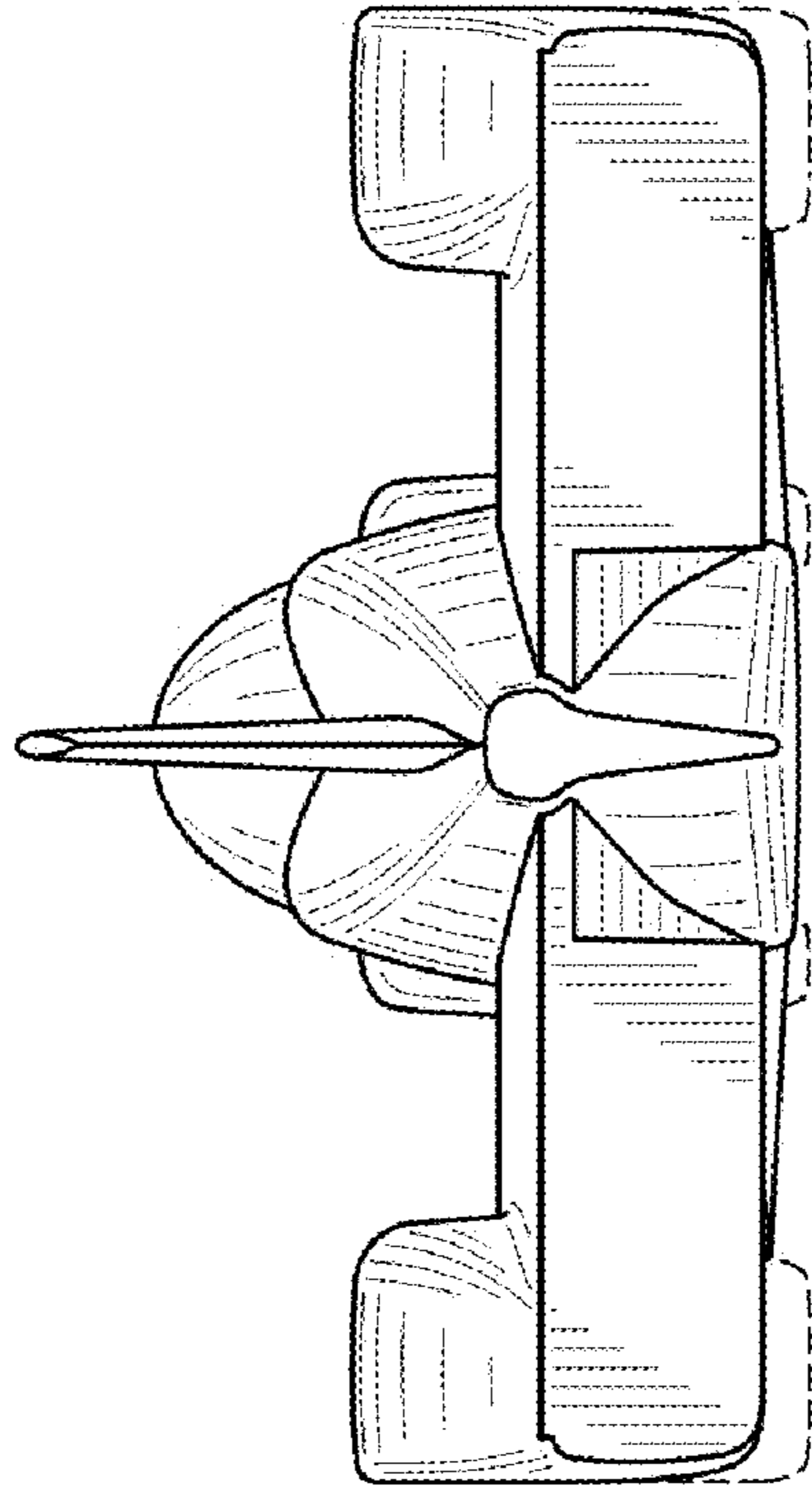

FIG. 6

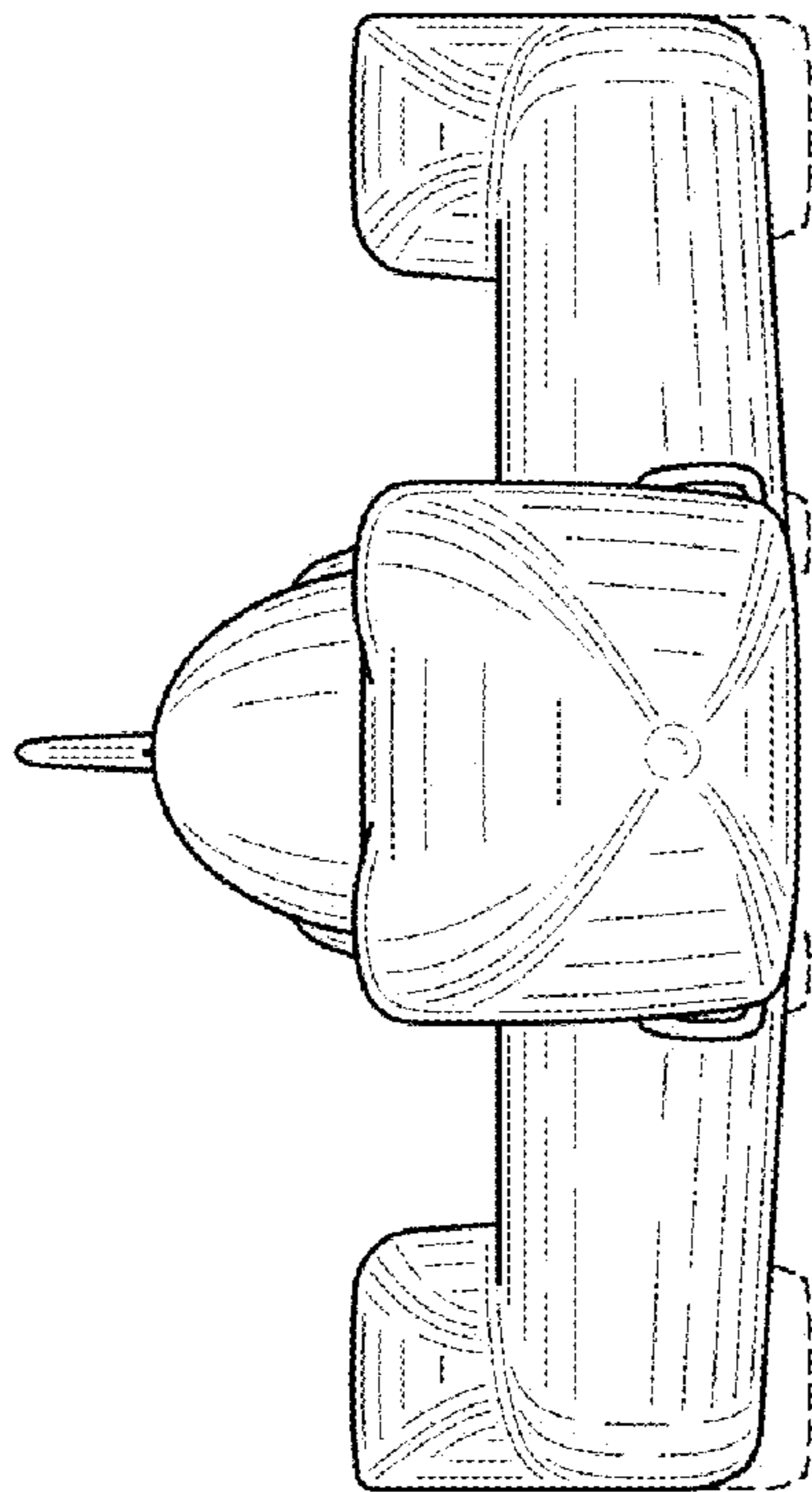

FIG. 7

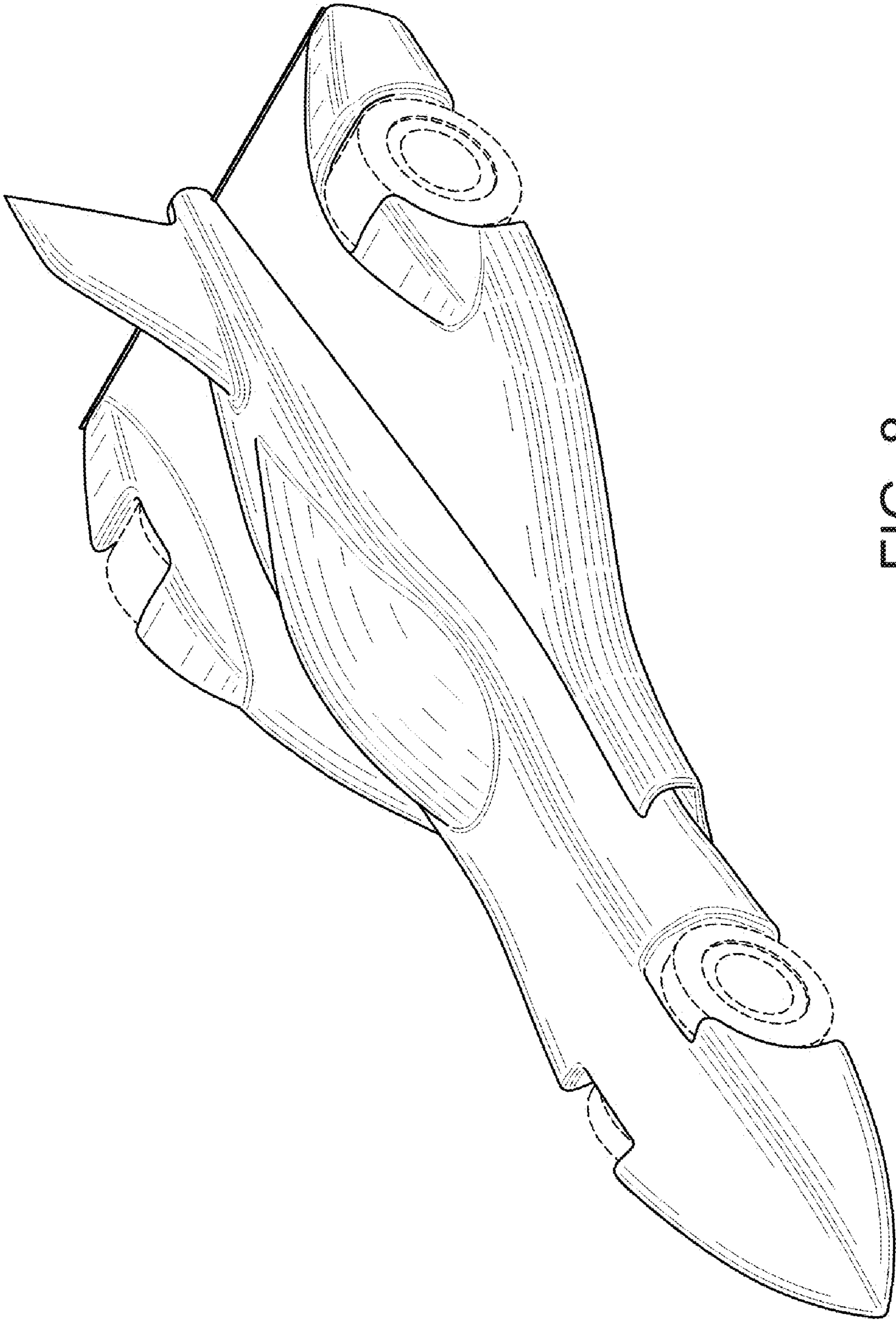

FIG. 8



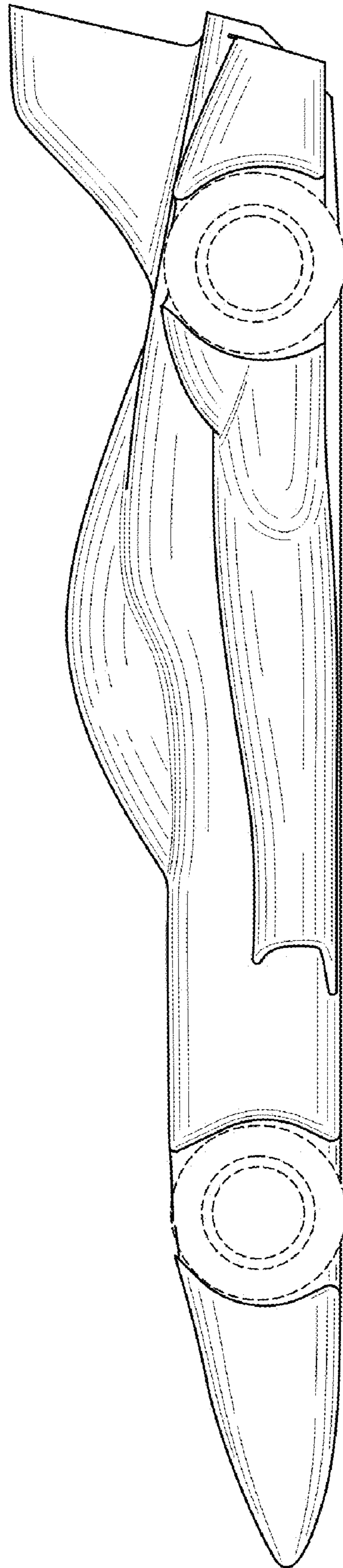

FIG. 9

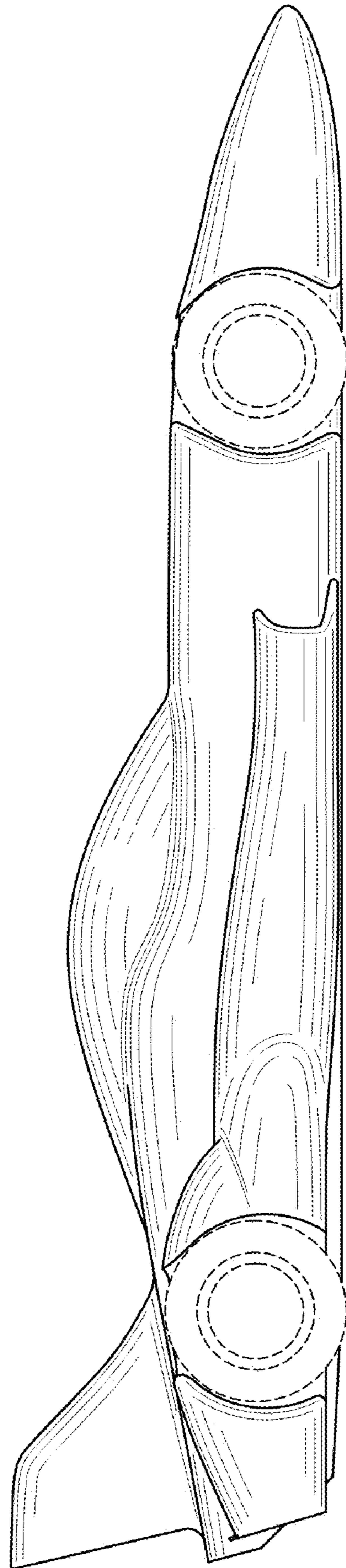

FIG. 10

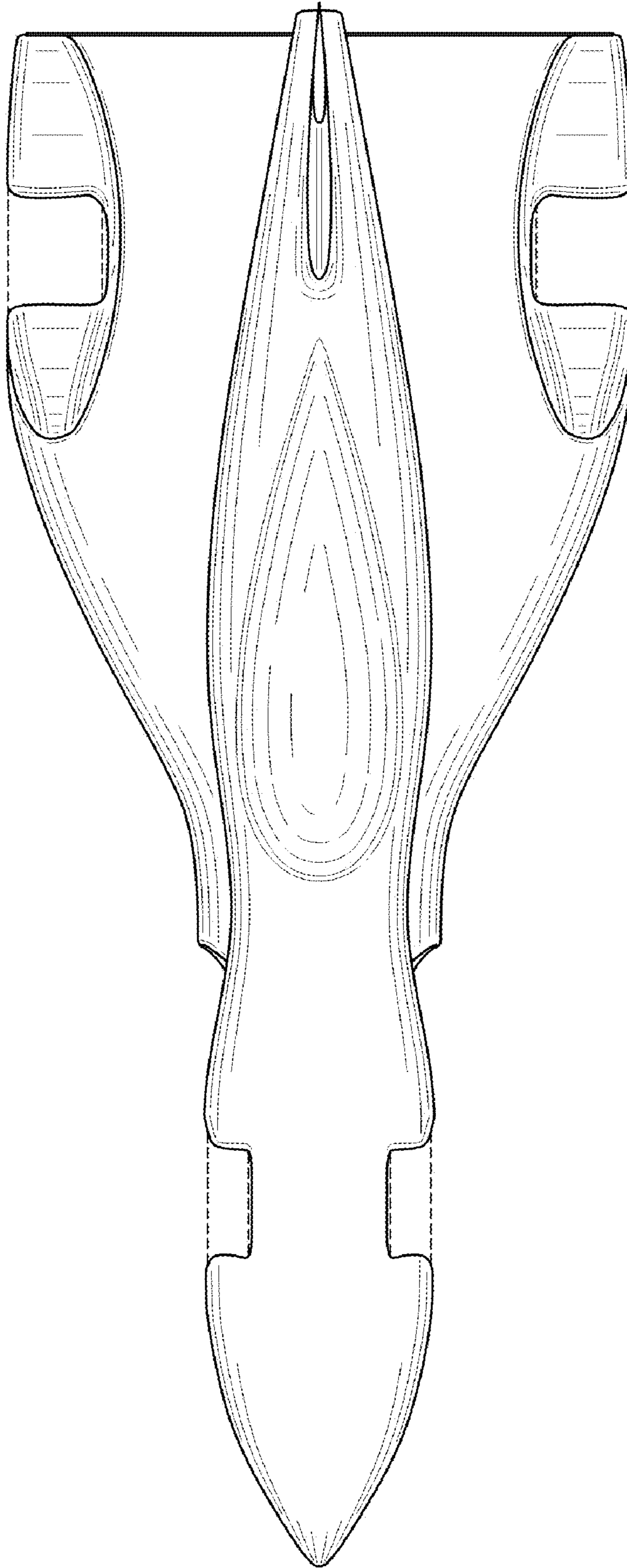

FIG. 11

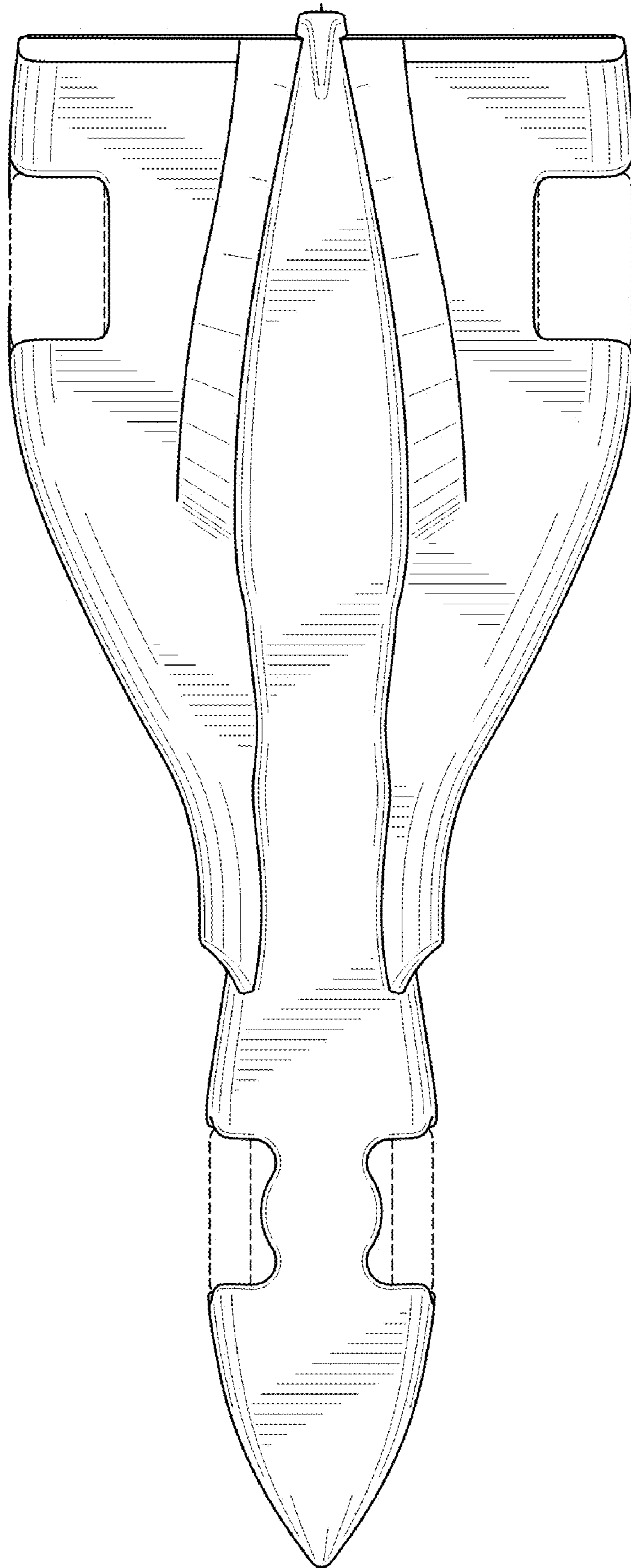

FIG. 12



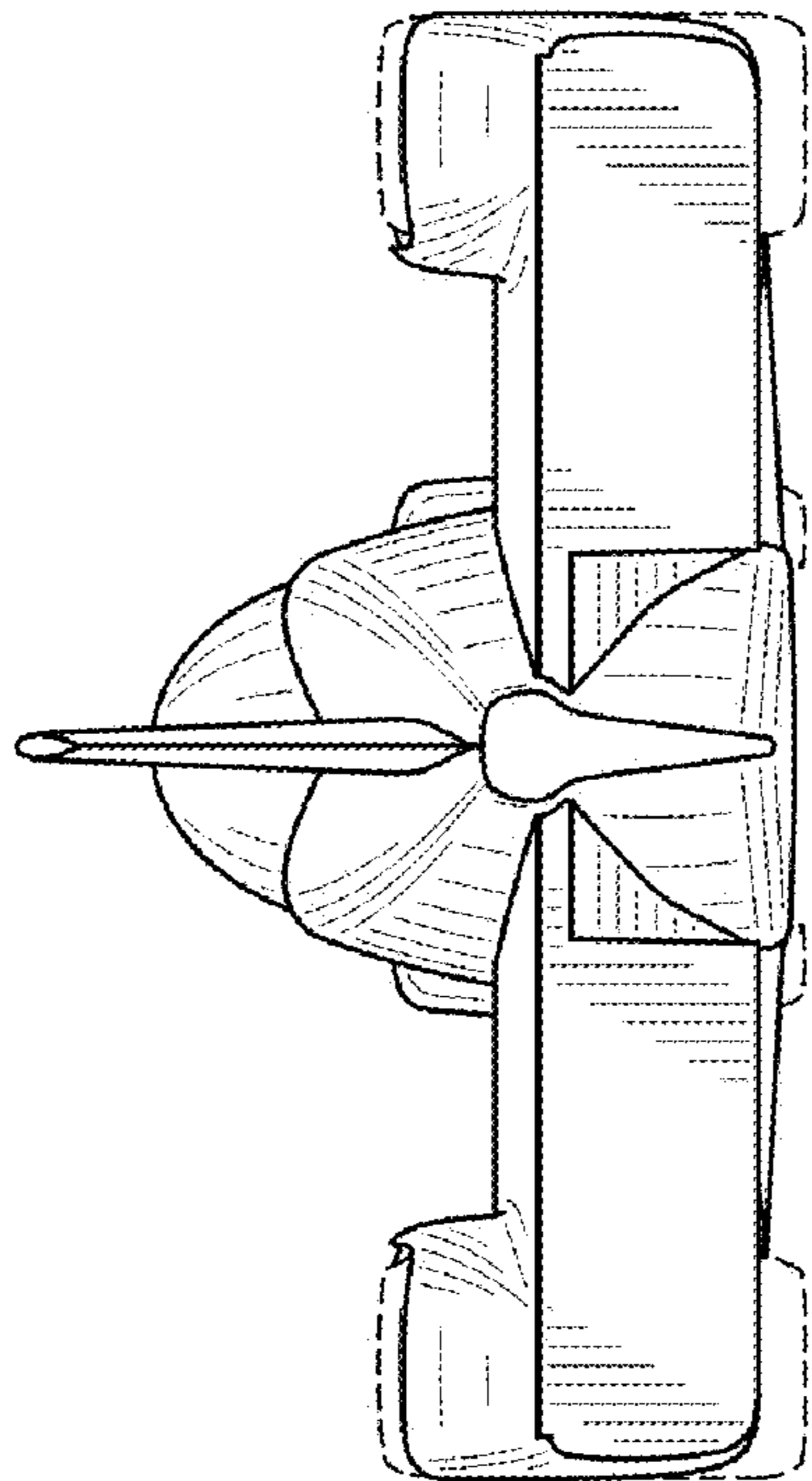

FIG. 14

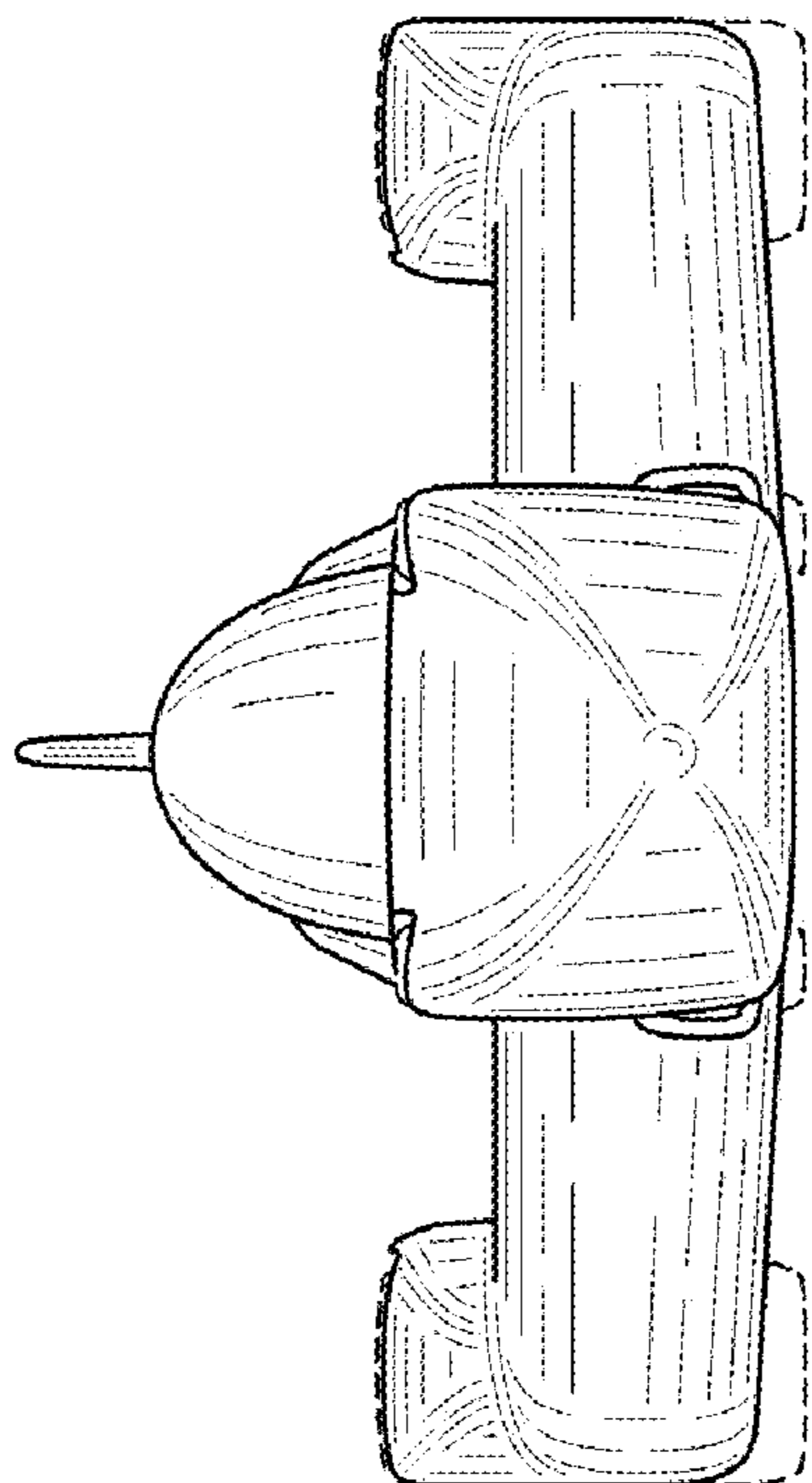

FIG. 13