



US00D644130S

(12) **United States Design Patent**
Thelen et al.

(10) **Patent No.:** **US D644,130 S**

(45) **Date of Patent:** **** Aug. 30, 2011**

(54) **TIMER**

(75) Inventors: **Arnold Thelen**, Idar-Oberstein (DE);
Ernst Wedekind, Köln (DE)

(73) Assignee: **Fissler GmbH**, Idar-Oberstein (DE)

(**) Term: **14 Years**

(21) Appl. No.: **29/385,245**

(22) Filed: **Feb. 10, 2011**

(51) **LOC (9) Cl.** **10-03**

(52) **U.S. Cl.** **D10/40; D10/15; D10/28**

(58) **Field of Classification Search** D10/40,
D10/41, 1, 2, 15, 21, 23, 26, 28; 368/107-120
See application file for complete search history.

(56) **References Cited**

U.S. PATENT DOCUMENTS

D284,358 S *	6/1986	Chan	D10/40
D288,299 S *	2/1987	Mark	D10/40
D303,771 S *	10/1989	Chan	D10/40
D318,019 S *	7/1991	van Lelyveld	D10/18
D320,357 S *	10/1991	Mizukami	D10/30
D337,952 S *	8/1993	Wolff	D10/30
D366,215 S *	1/1996	George et al.	D10/18
D382,008 S *	8/1997	Mak	D18/2
D427,085 S *	6/2000	Steinhagen	D10/40
D467,822 S *	12/2002	Hsu	D10/40

D476,239 S *	6/2003	Hsu	D10/18
D488,393 S *	4/2004	Hsu	D10/40
D500,449 S *	1/2005	Olszowy	D10/23
D512,653 S *	12/2005	Chan	D10/15
D531,058 S *	10/2006	Bhavnani	D10/1
D567,108 S *	4/2008	Chang	D10/2

* cited by examiner

Primary Examiner — Lucy Lieberman

(74) *Attorney, Agent, or Firm* — Foley & Lardner LLP

(57) **CLAIM**

We claim the ornamental design for a timer, as shown and described.

DESCRIPTION

FIG. 1 is a perspective view of a timer according to our new design;

FIG. 2 is a top view of the timer shown in FIG. 1;

FIG. 3 is a bottom view of the timer shown in FIG. 1;

FIG. 4 is a front view of the timer shown in FIG. 1;

FIG. 5 is a rear view of the timer shown in FIG. 1;

FIG. 6 is a right side view of the timer shown in FIG. 1; and,

FIG. 7 is a left side view of the timer shown in FIG. 1.

The ornamental design which is claimed is shown in solid lines in the drawings. Broken lines in the drawings are for illustrative purposes only and form no part of the claimed design.

1 Claim, 3 Drawing Sheets

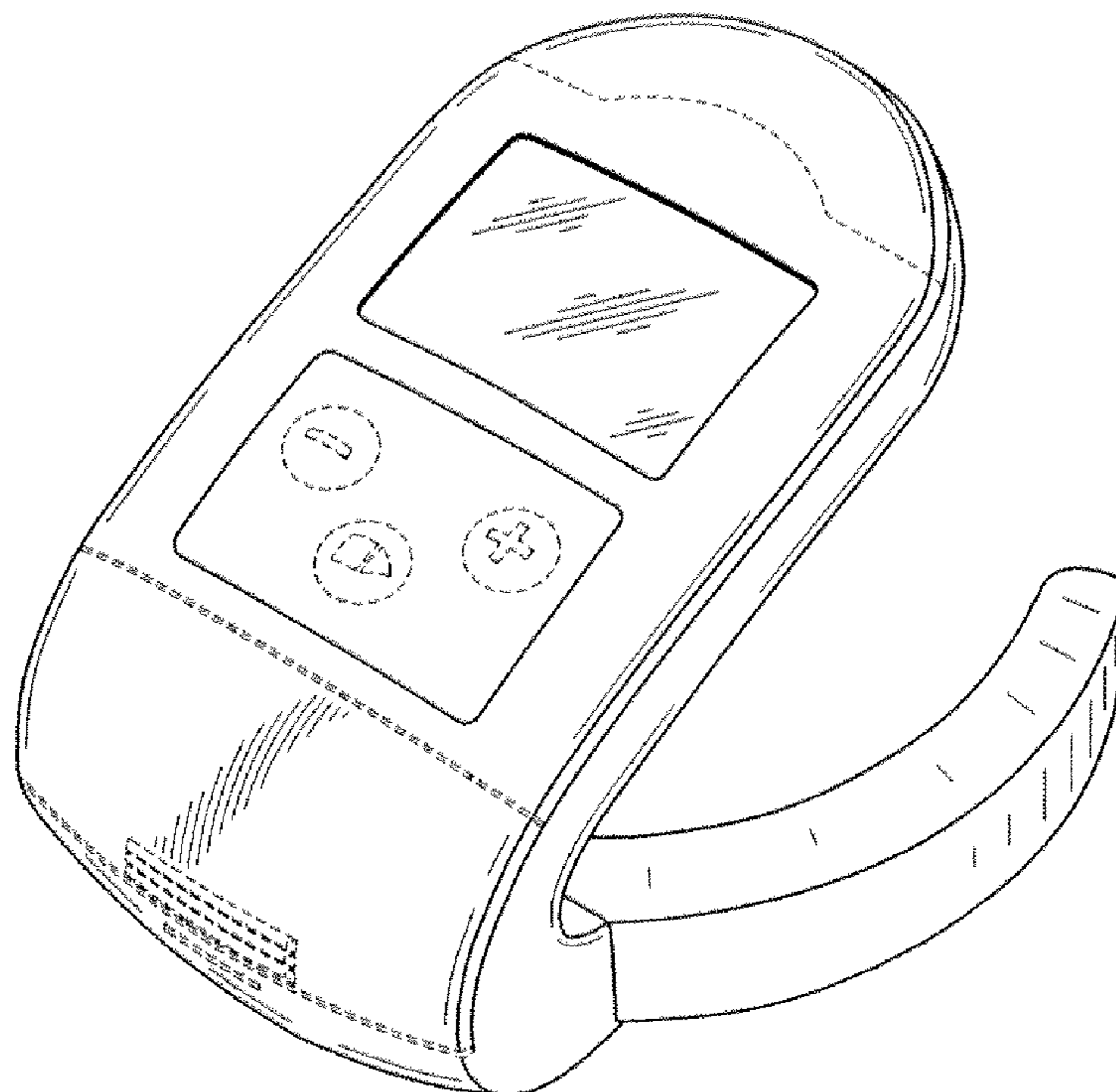

Fig. 1

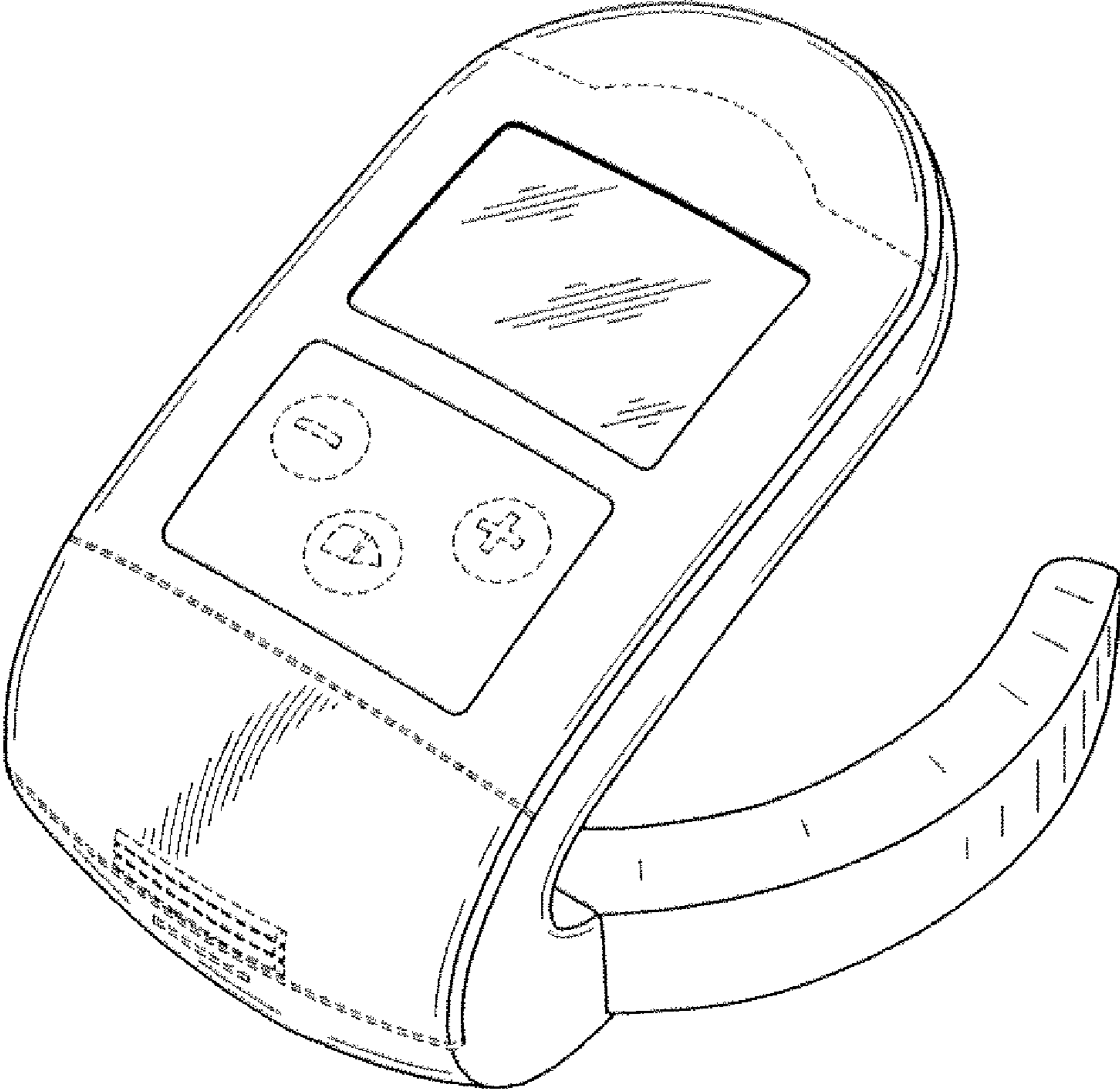

Fig. 2

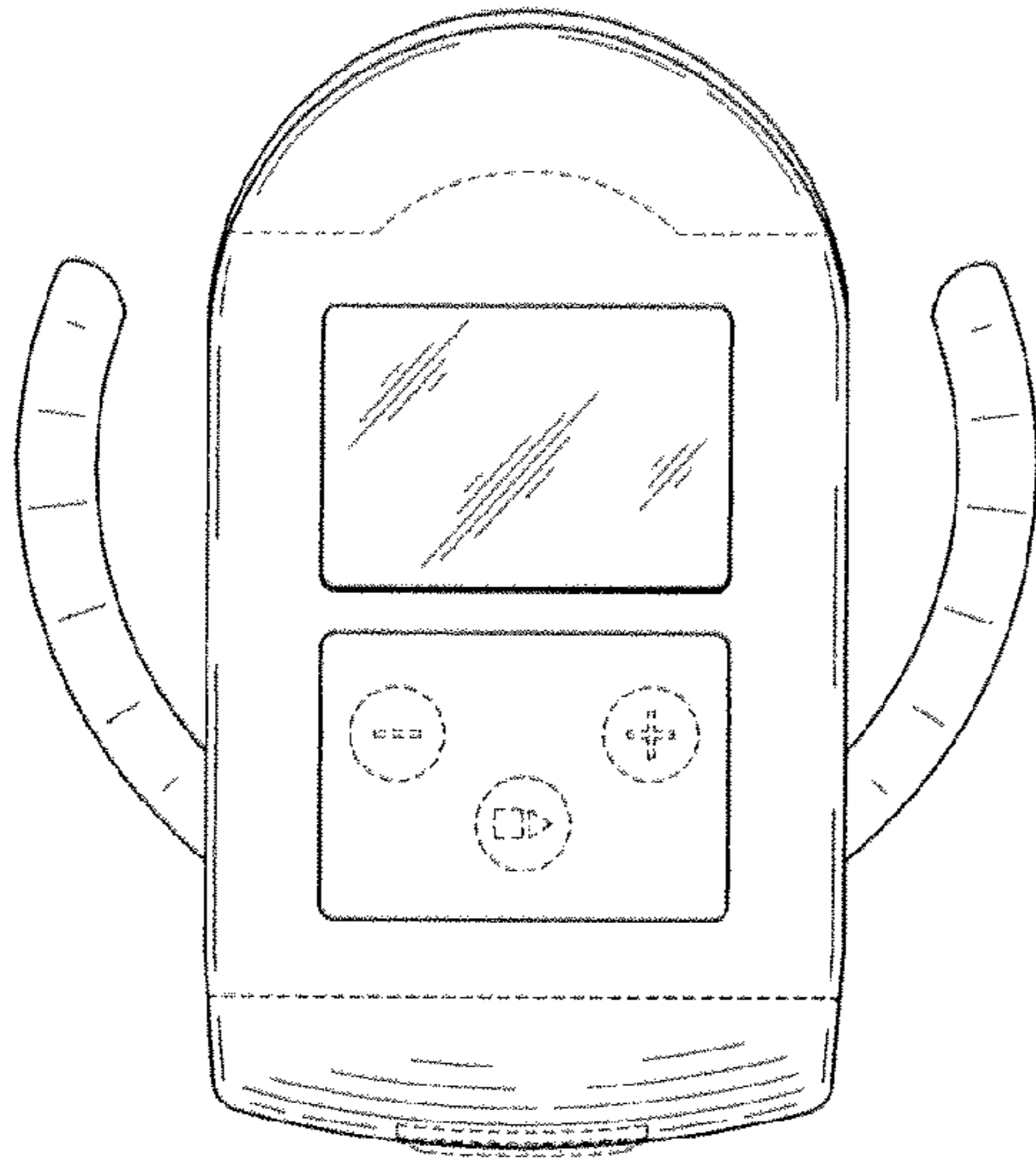

Fig. 3

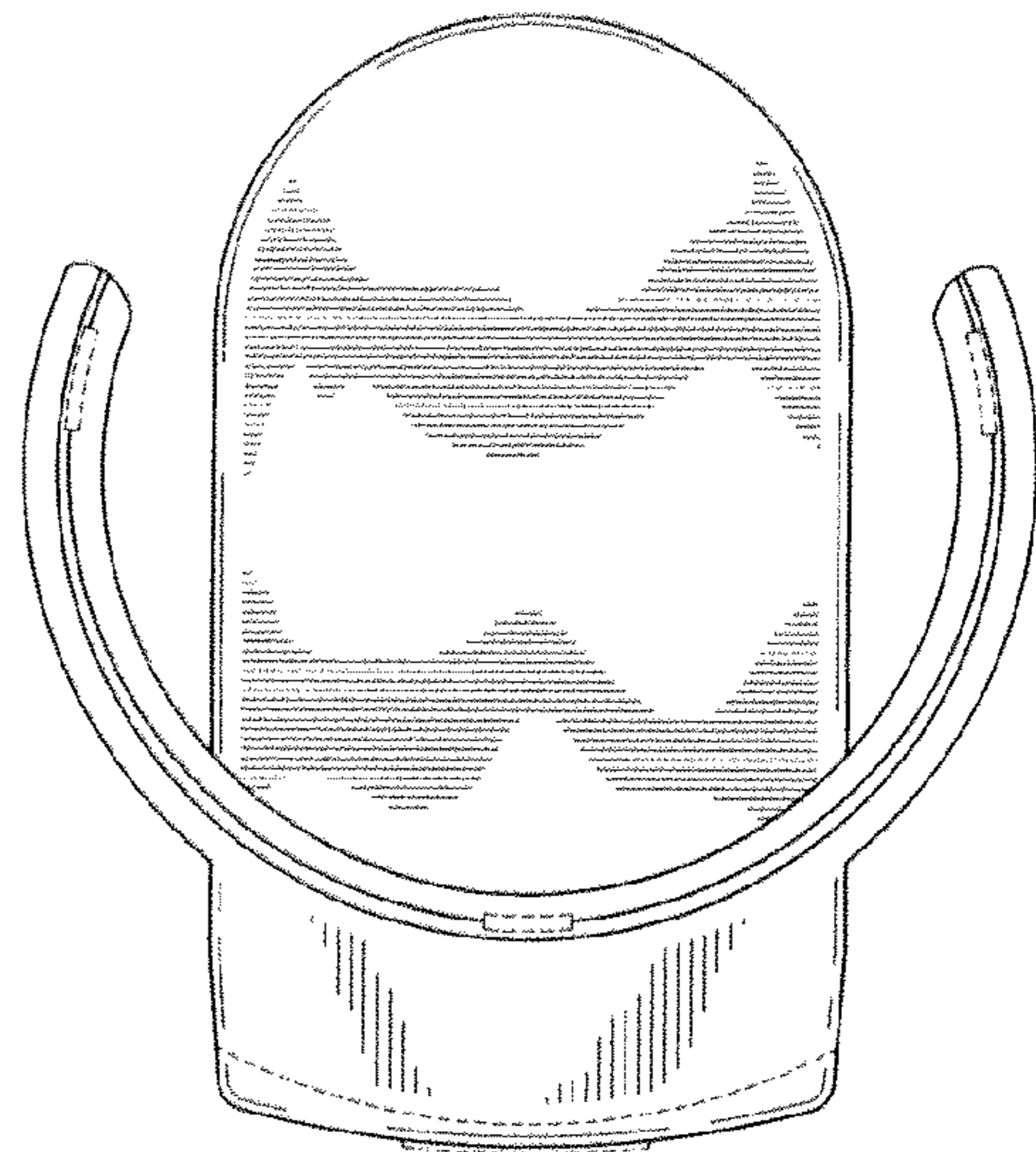

Fig. 4

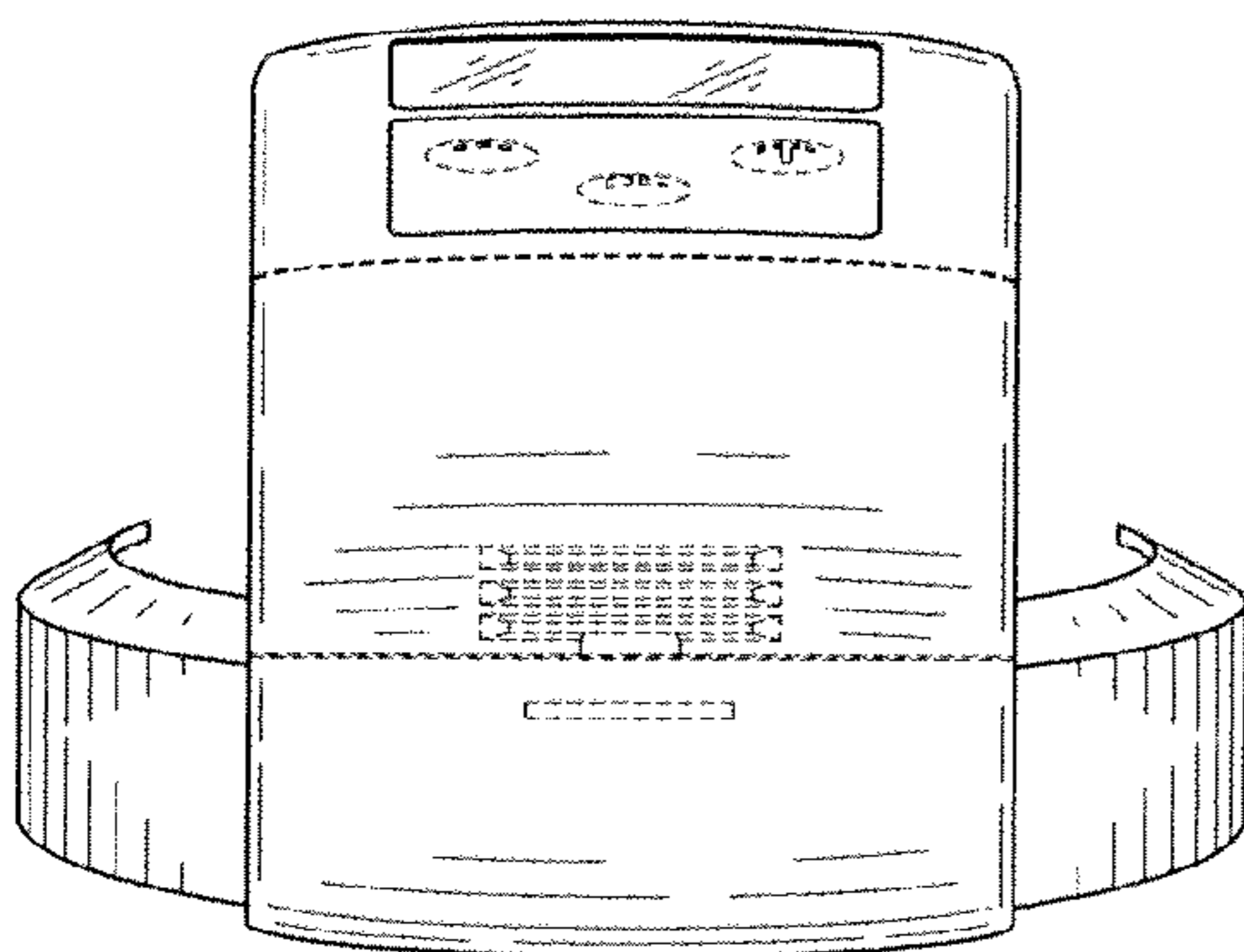

Fig. 5

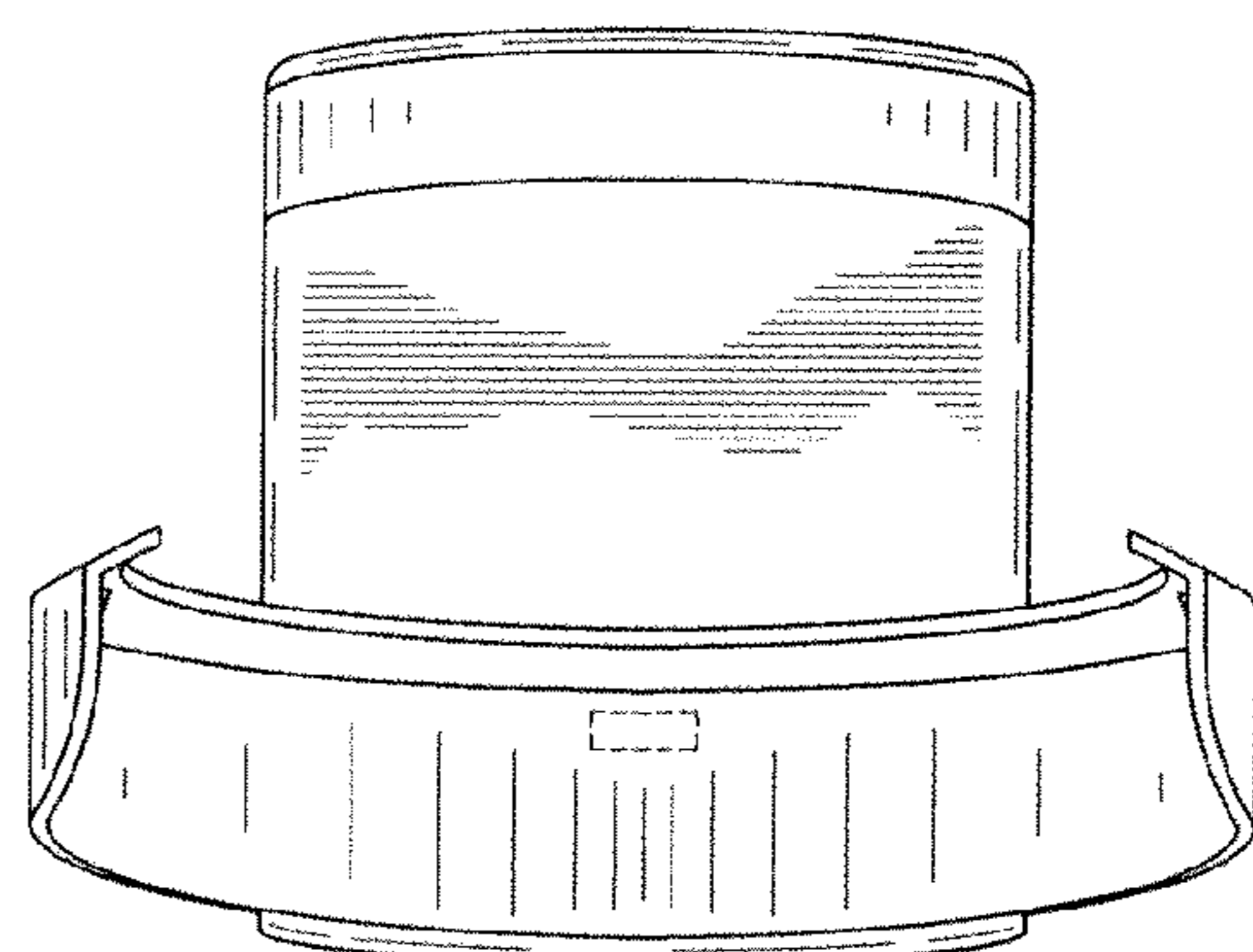

Fig. 6

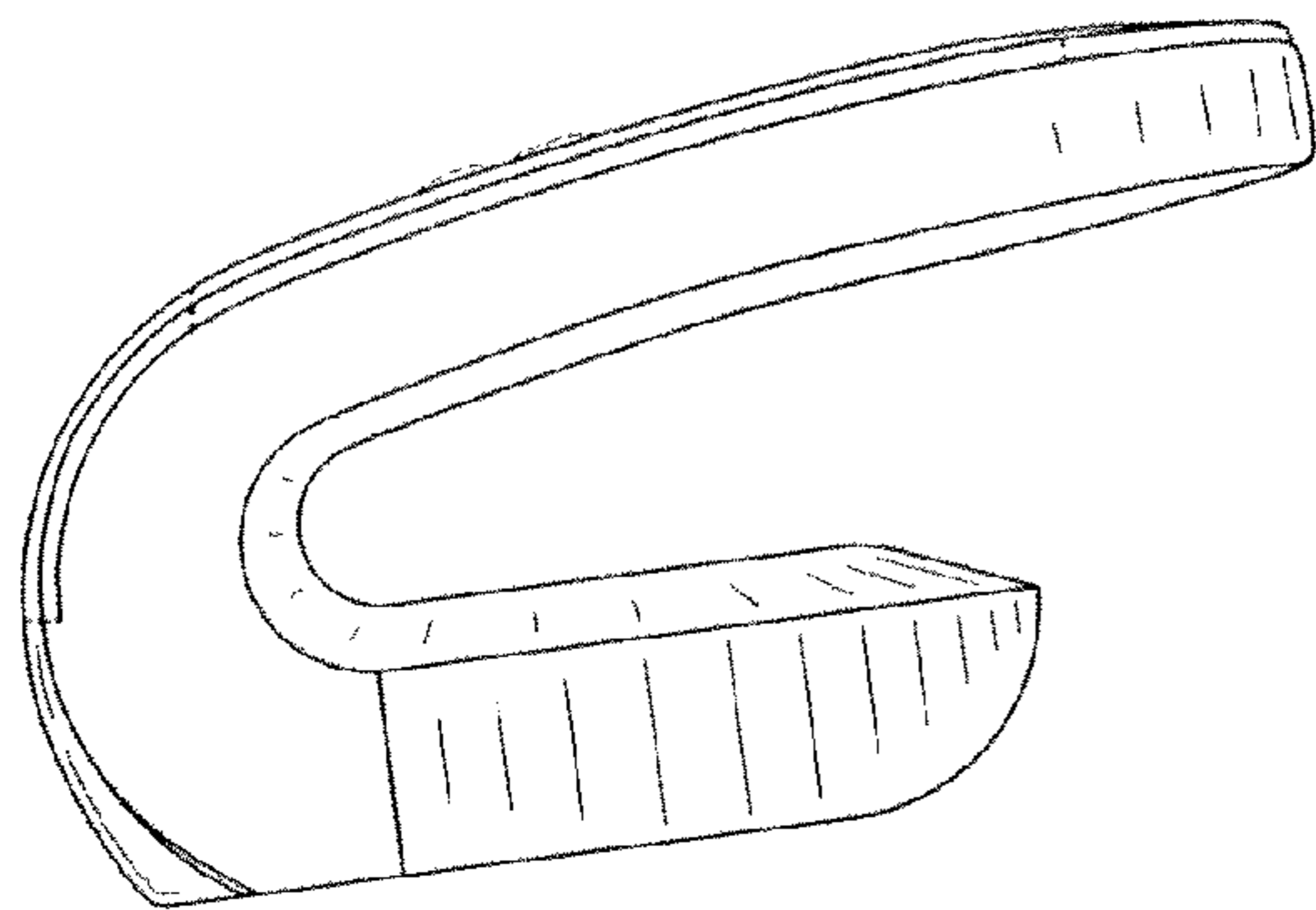

Fig. 7

