



US00D644122S

(12) **United States Design Patent**  
**Kight et al.**

(10) **Patent No.:** **US D644,122 S**  
(45) **Date of Patent:** **\*\* Aug. 30, 2011**

(54) **WINDOW FOR PACKAGING**

(75) Inventors: **Melissa Kight**, West Jordan, UT (US);  
**Lucas Echeverria**, West Valley City, UT  
(US); **Michelle Erikson**, West Valley  
City, UT (US)

(73) Assignee: **The Sun Products Corporation**,  
Wilton, CT (US)

(\*\*) Term: **14 Years**

(21) Appl. No.: **29/369,942**

(22) Filed: **Sep. 15, 2010**

(51) **LOC (9) Cl.** ..... **09-05**

(52) **U.S. Cl.** ..... **D9/707**; D9/418; D9/434

(58) **Field of Classification Search** ..... D9/702-714,  
D9/720-721, 643-648, 414-418, 430-433,  
D9/761, 434; 426/106; 222/92, 107; 383/61.1,  
383/78, 108, 112, 106; 229/87.06, 87.08,  
229/902-904, 123.2, 125.4, 407, 162.6, 162.7,  
229/162.3, 162.1, 125.04; D6/470; 428/34.1;  
D7/602, 607; 206/485, 484, 811; 220/4.21,  
220/666, 662, 602

See application file for complete search history.

(56) **References Cited**

**U.S. PATENT DOCUMENTS**

D396,329 S *	7/1998	Litton	.....	D28/82
D429,459 S	8/2000	Berman		
D437,549 S	2/2001	Berman		
D440,868 S	4/2001	Berman		
D452,818 S	1/2002	Berman		
D462,264 S *	9/2002	Barr et al.	.....	D9/416
D469,349 S *	1/2003	Meeker et al.	.....	D9/418
D499,636 S	12/2004	Bennie et al.		
D502,392 S *	3/2005	Maher et al.	.....	D9/418
D510,277 S	10/2005	Bennie et al.		
D527,252 S *	8/2006	Bolt et al.	.....	D9/418
D547,644 S *	7/2007	Harper et al.	.....	D9/418
D570,680 S *	6/2008	Wintmolders et al.	.....	D9/418
D576,483 S *	9/2008	Wintmolders et al.	.....	D9/418

D594,741 S *	6/2009	Bracey	.....	D9/418
D612,234 S	3/2010	Westemeyer		
D622,139 S *	8/2010	Marcott et al.	.....	D9/418
D628,882 S *	12/2010	Work et al.	.....	D9/418

**OTHER PUBLICATIONS**

U.S. Appl. No. 29/369,945, "Window for Packaging", filed Sep. 15, 2010.

U.S. Appl. No. 29/369,651, "Window for Packaging", filed Sep. 10, 2010.

\* cited by examiner

*Primary Examiner* — Caron D Veynar

*Assistant Examiner* — Abraham Bahta

(74) *Attorney, Agent, or Firm* — Sterne, Kessler, Goldstein & Fox P.L.L.C.

(57) **CLAIM**

The ornamental design for a window for packaging, as shown and described.

**DESCRIPTION**

FIG. 1 is a top perspective view of a window for packaging showing an embodiment of my new design;

FIG. 2 is a front view thereof;

FIG. 3 is a rear view thereof;

FIG. 4 is a right side view thereof;

FIG. 5 is a left side view thereof;

FIG. 6 is a top plan view thereof;

FIG. 7 is a bottom plan view thereof;

FIG. 8 is a top perspective view of a window for packaging showing an embodiment of my new design;

FIG. 9 is a front view thereof;

FIG. 10 is a rear view thereof;

FIG. 11 is a right side view thereof;

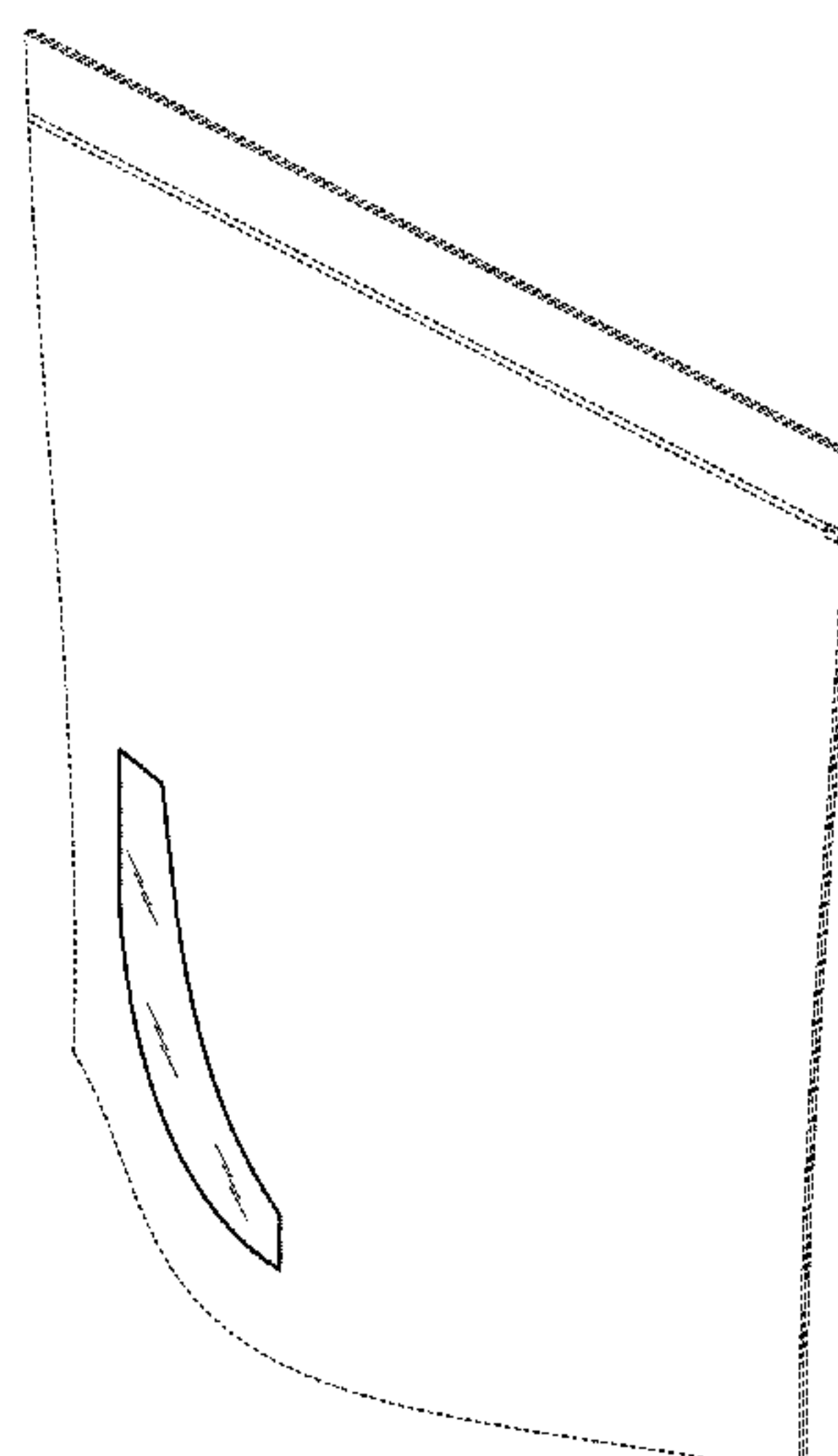
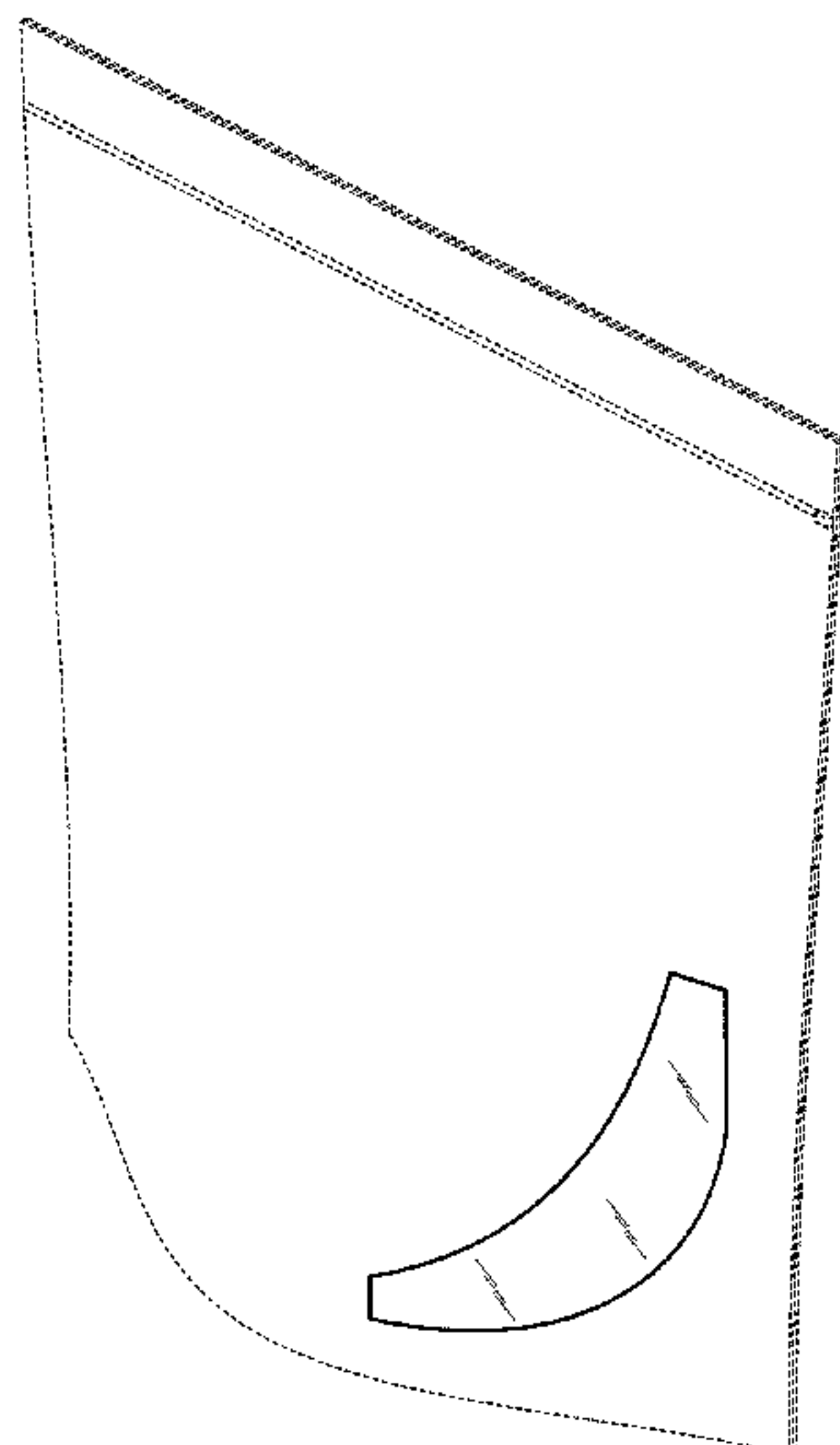
FIG. 12 is a left side view thereof;

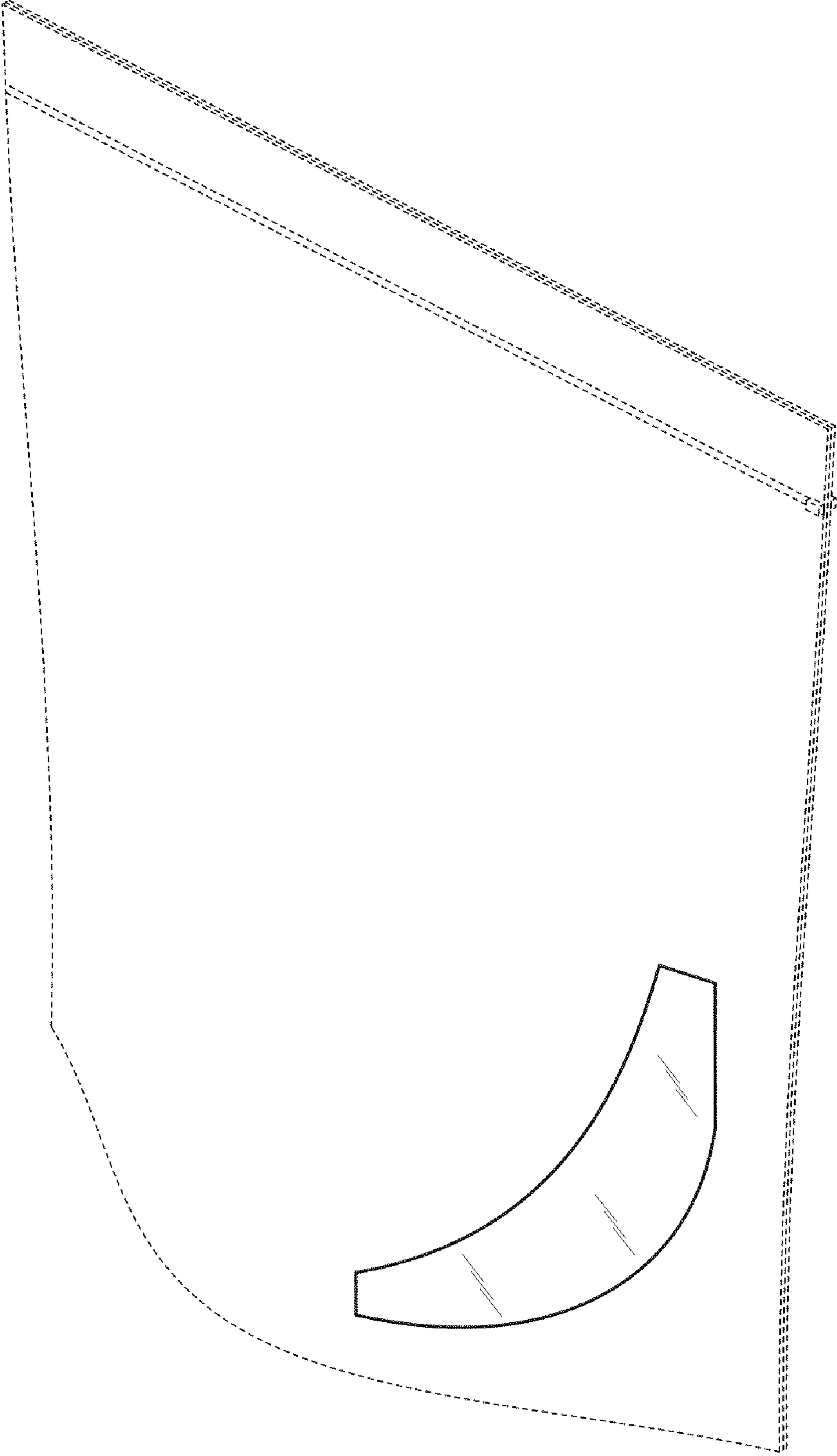
FIG. 13 is a top plan view thereof; and,

FIG. 14 is a bottom plan view thereof.

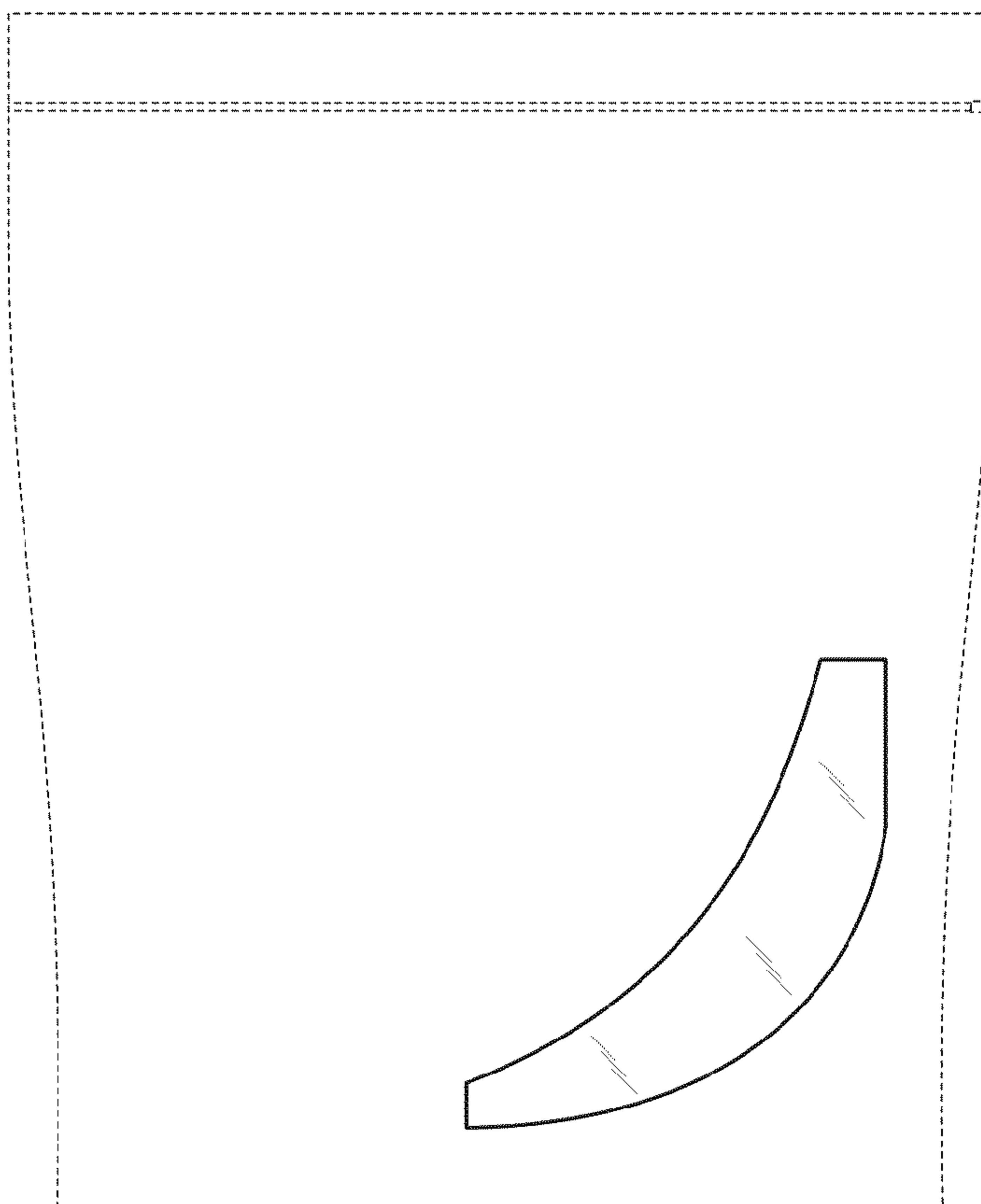
The broken lines show portions of the packaging which form no part of the claimed design.

**1 Claim, 6 Drawing Sheets**

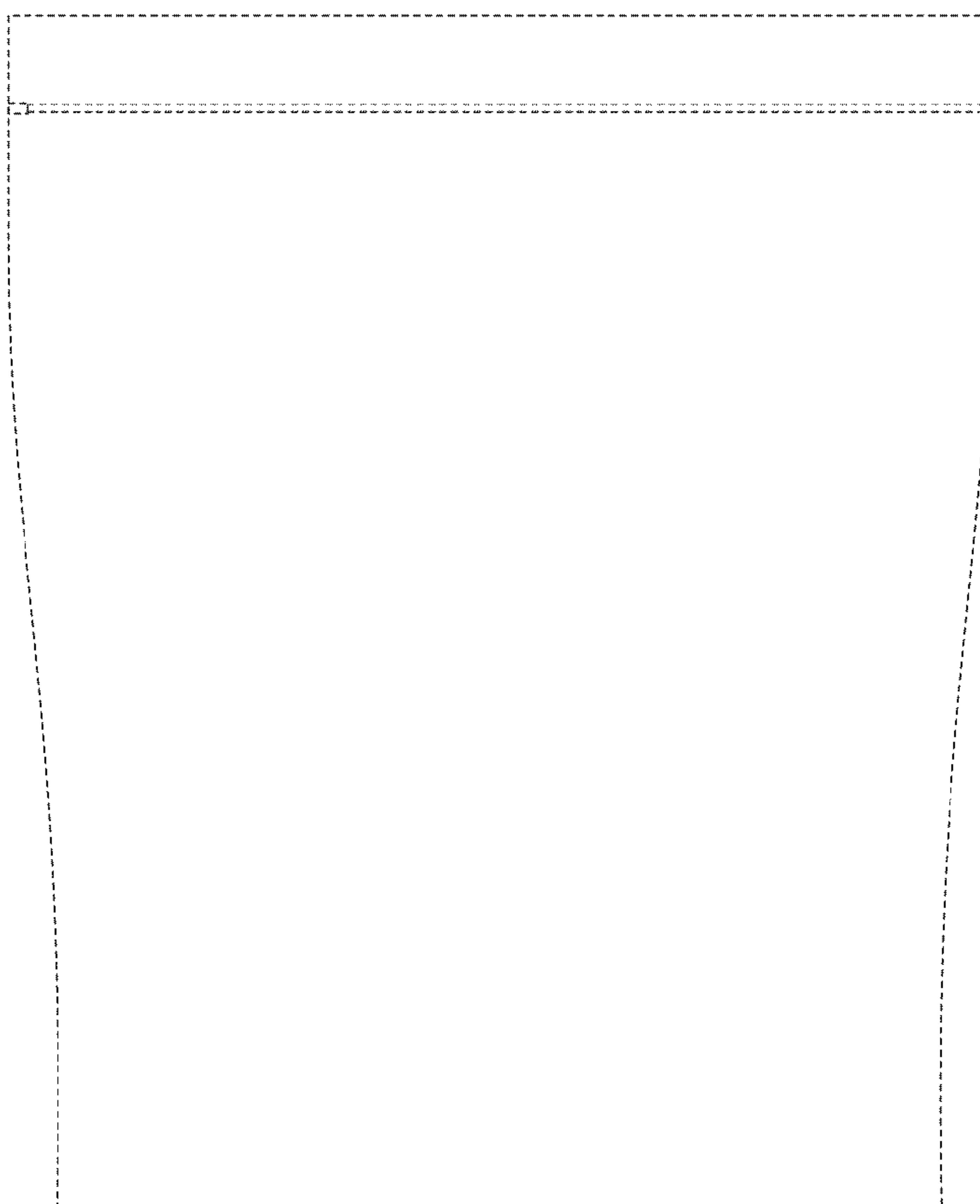




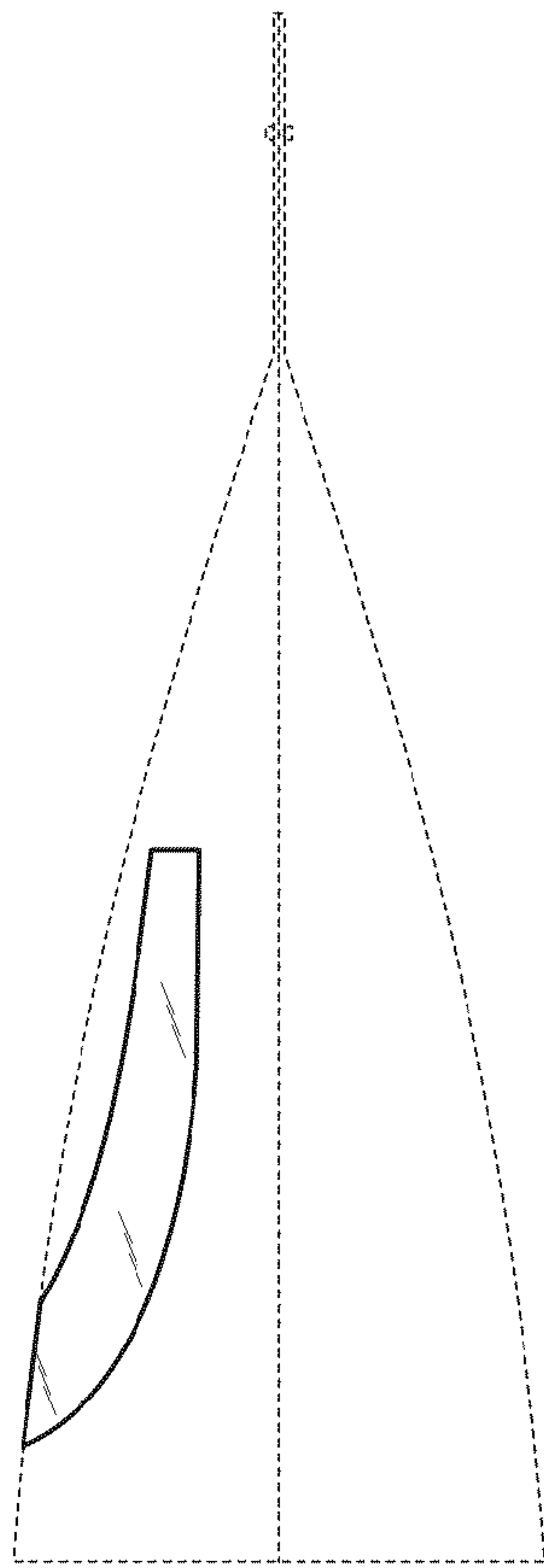
**FIG. 1**



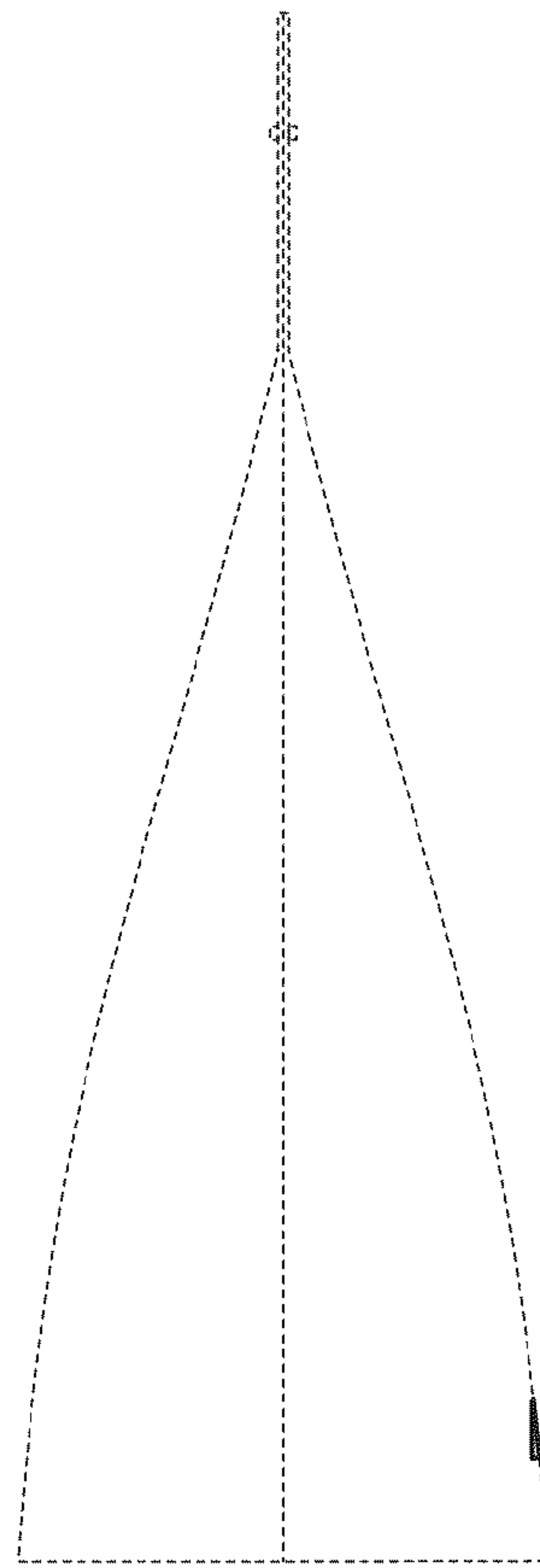
**FIG. 2**



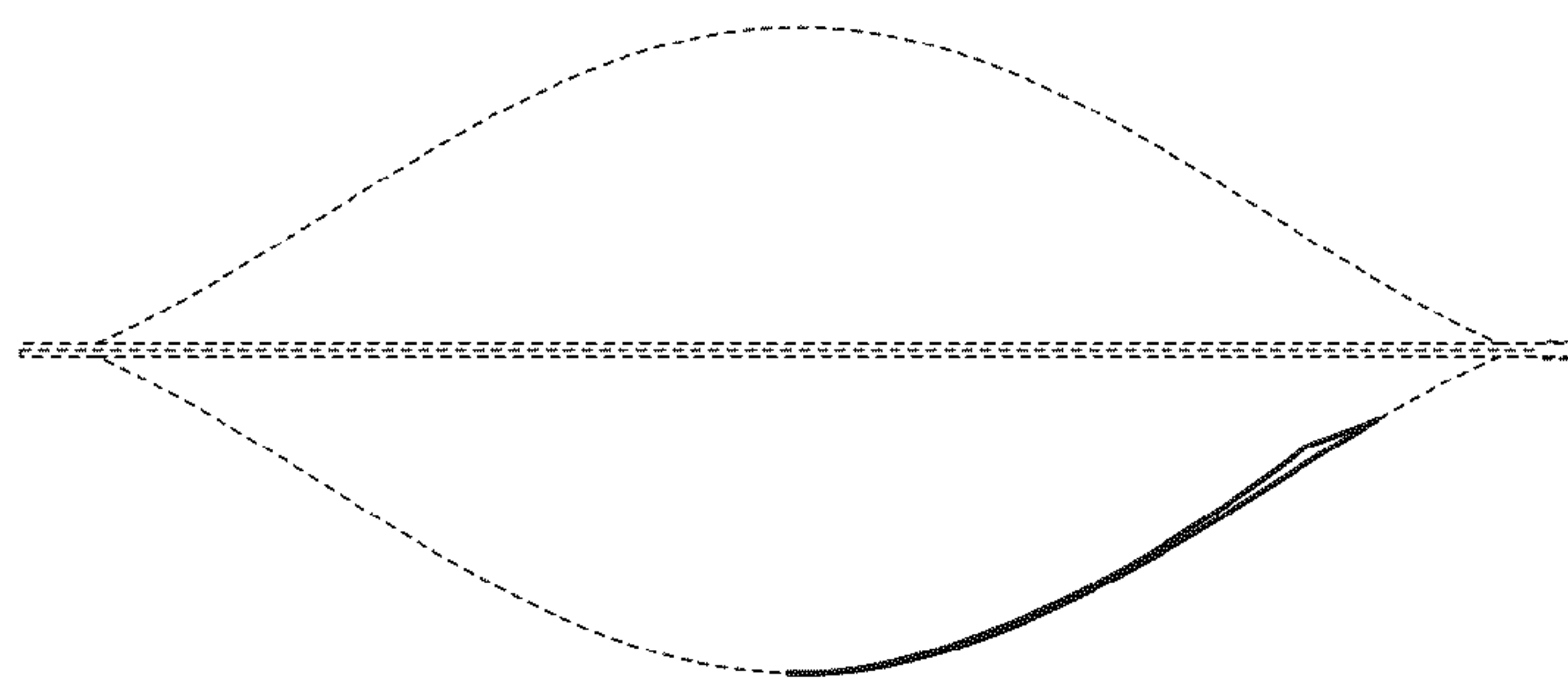
**FIG. 3**



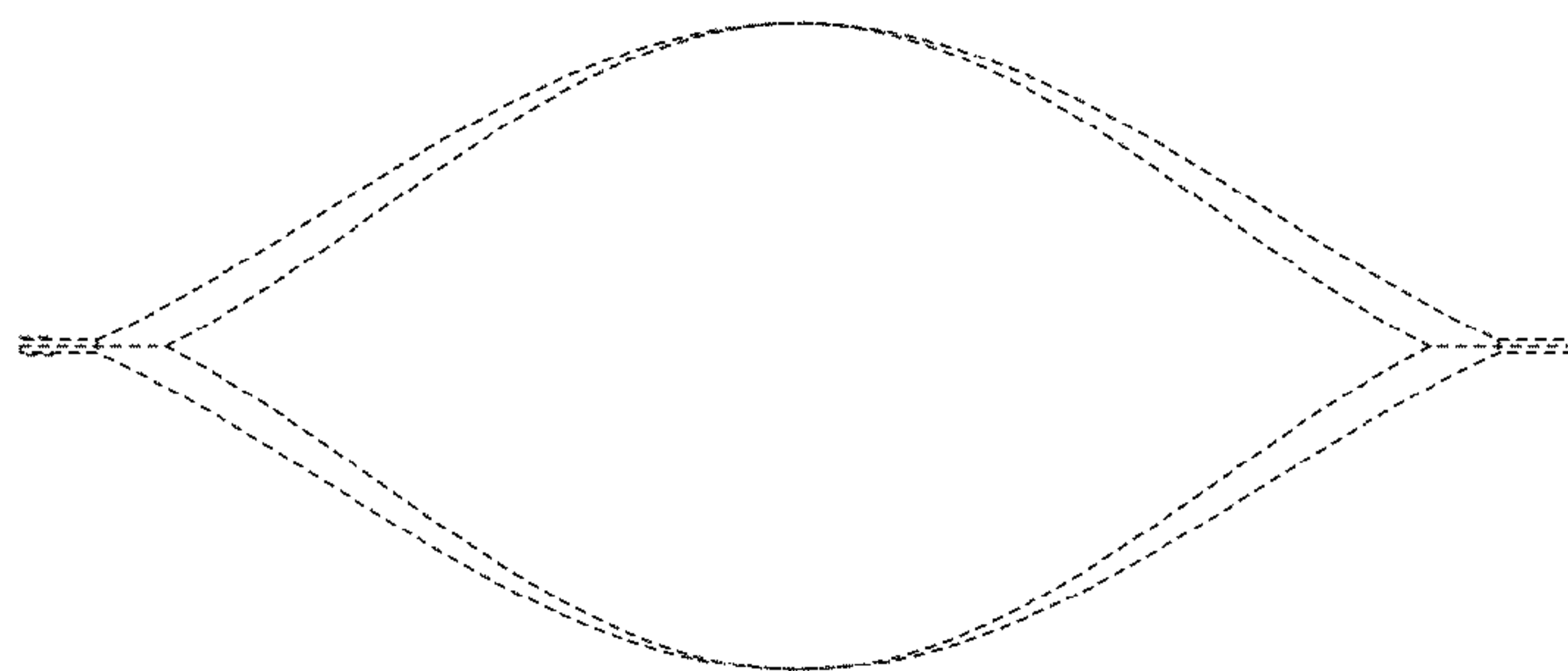
**FIG. 4**



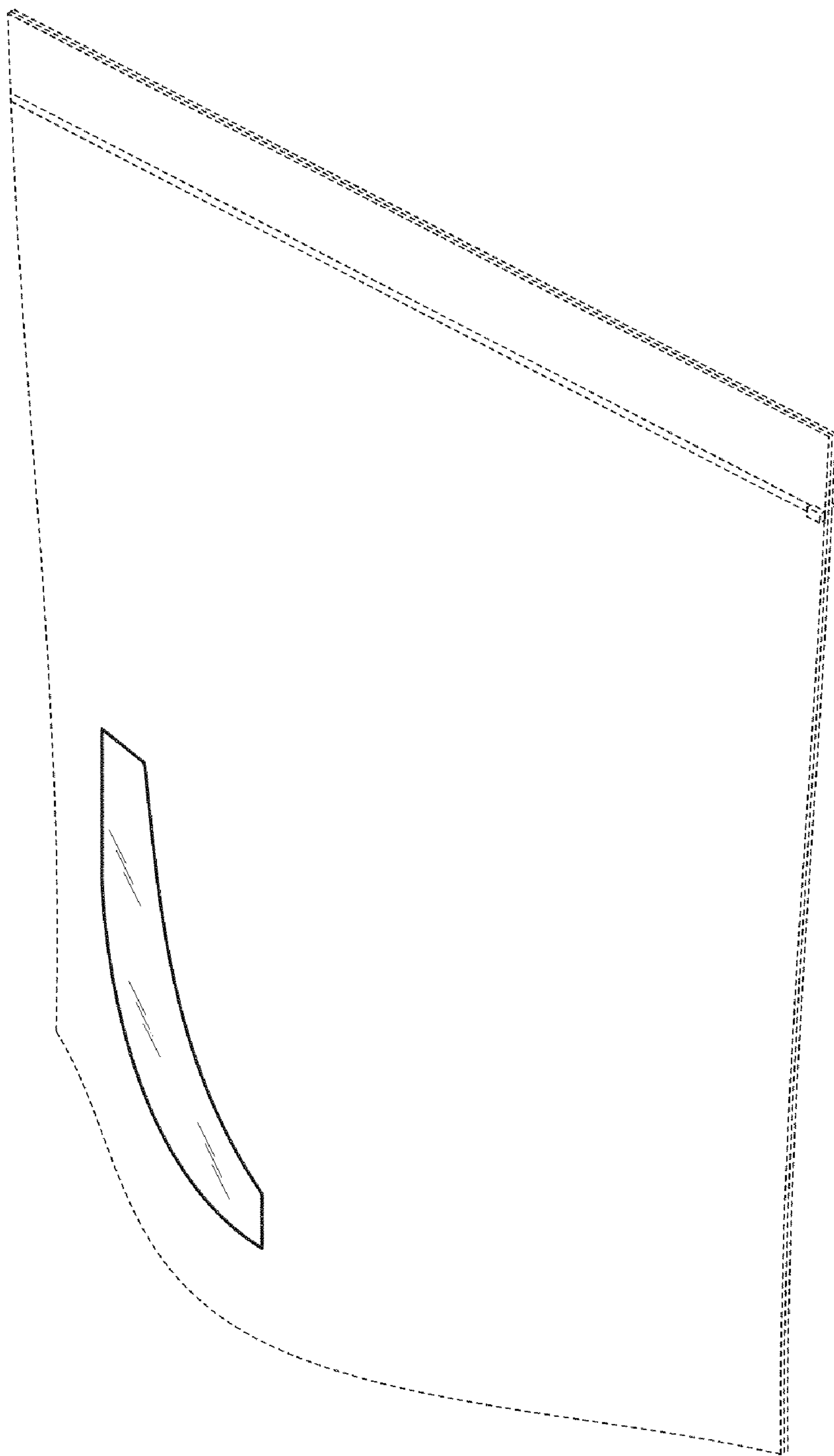
**FIG. 5**



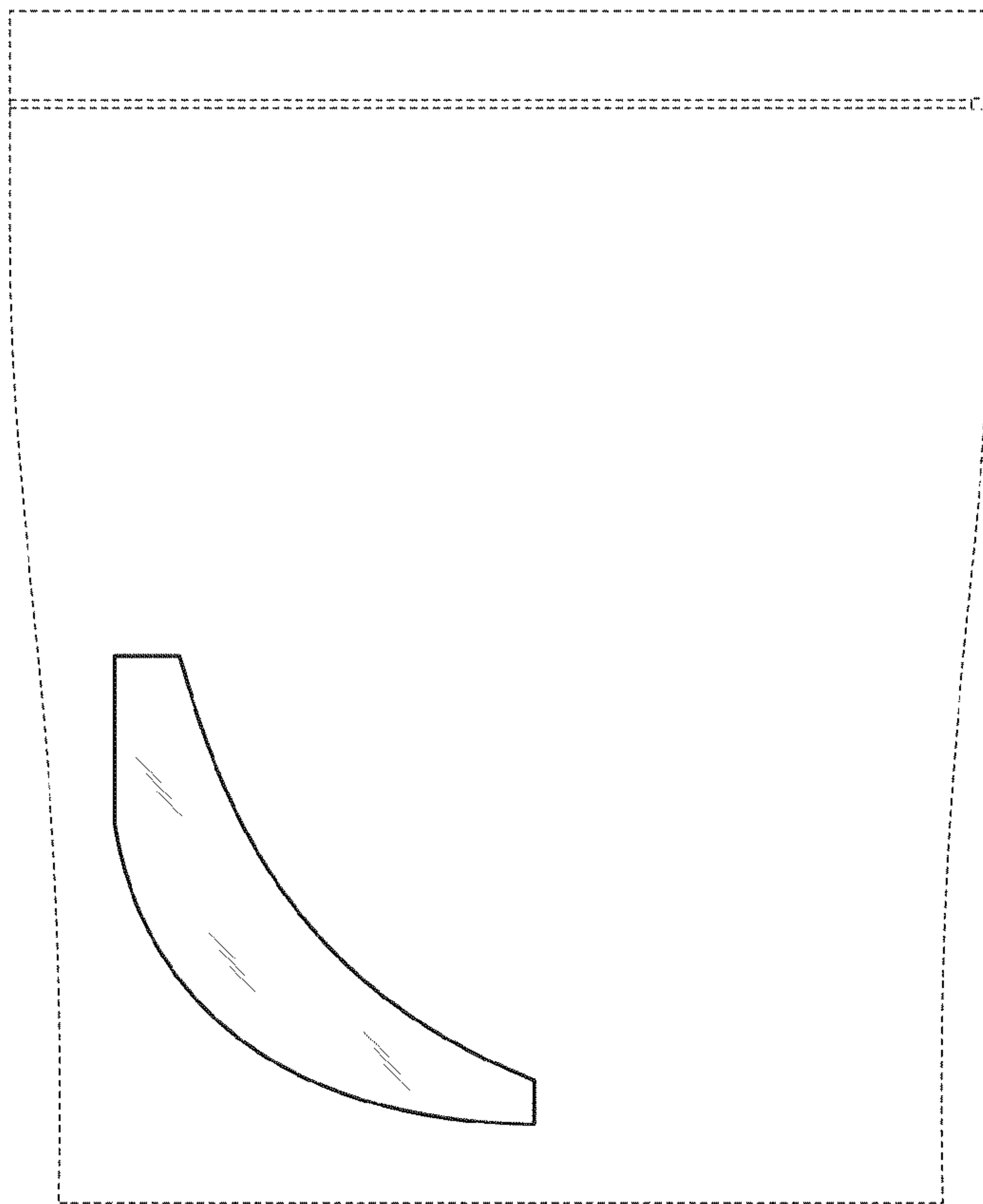
**FIG. 6**



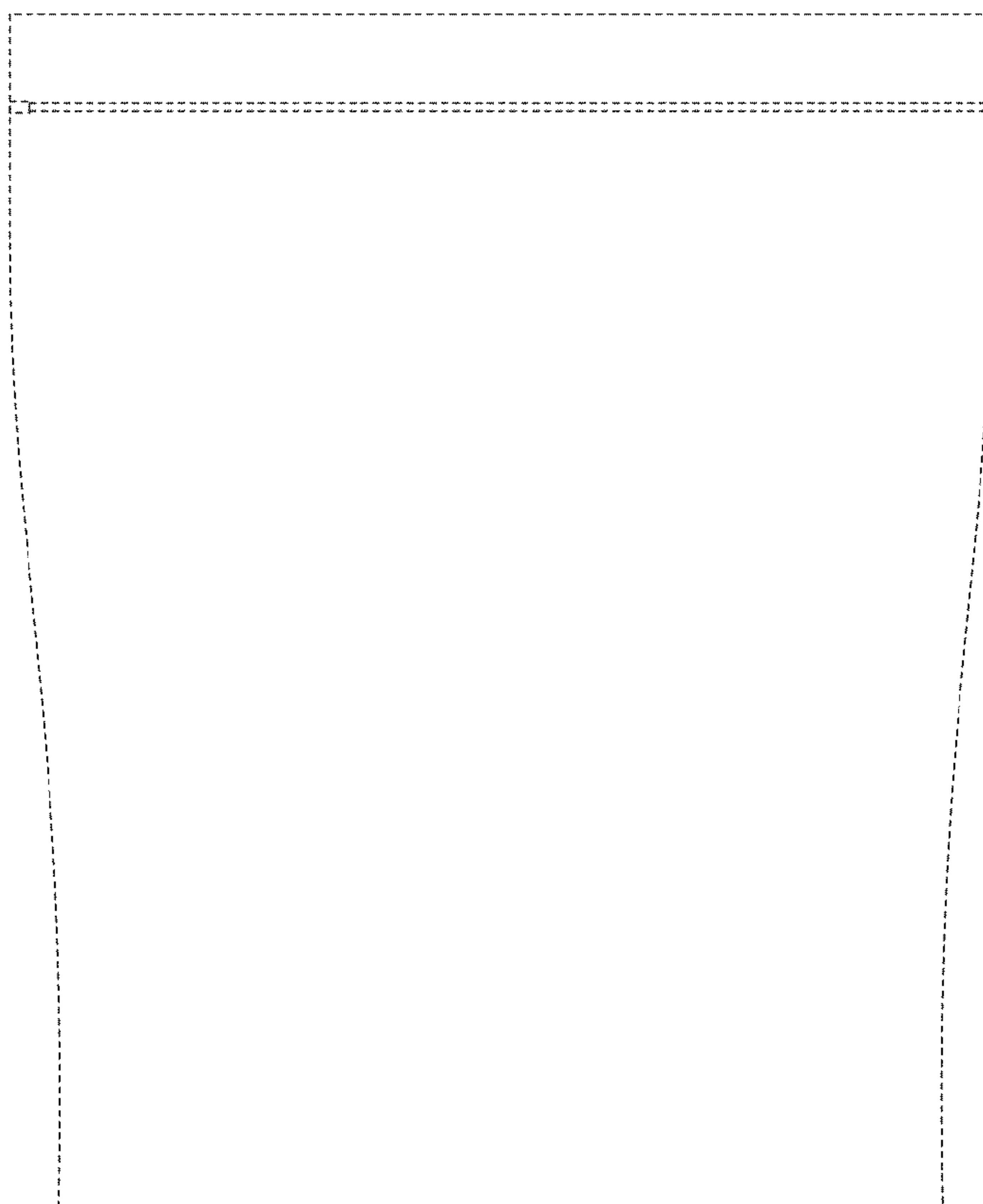
**FIG. 7**



**FIG. 8**

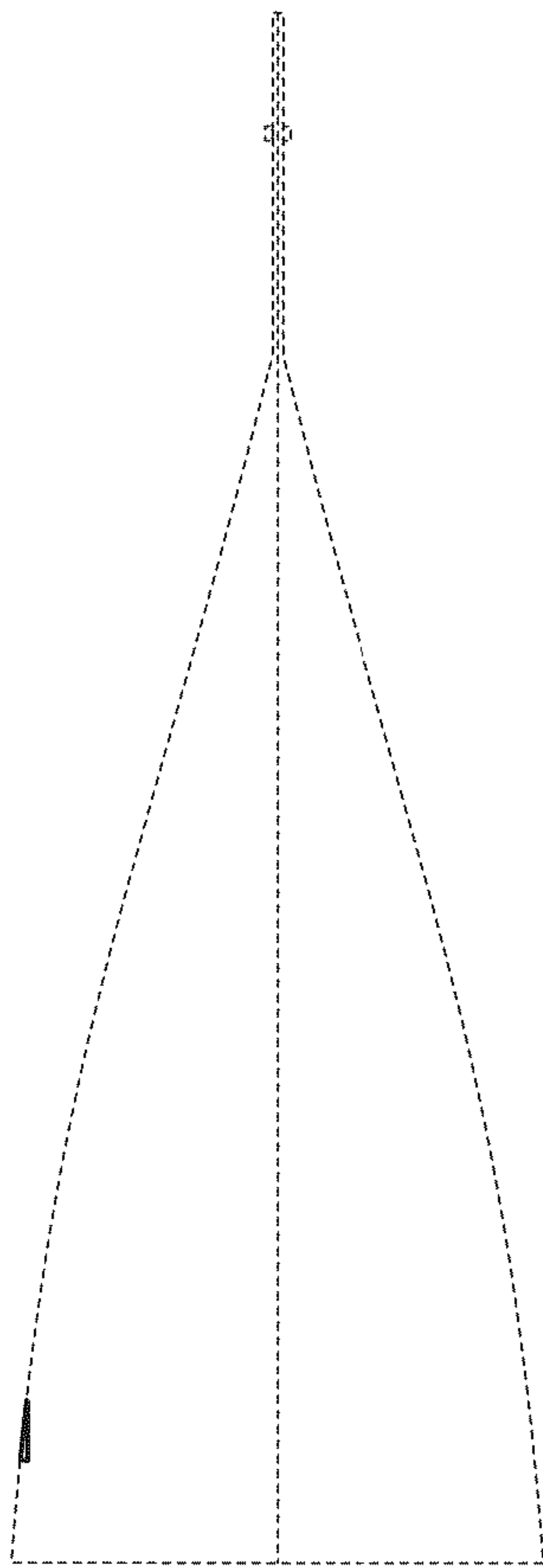


**FIG. 9**

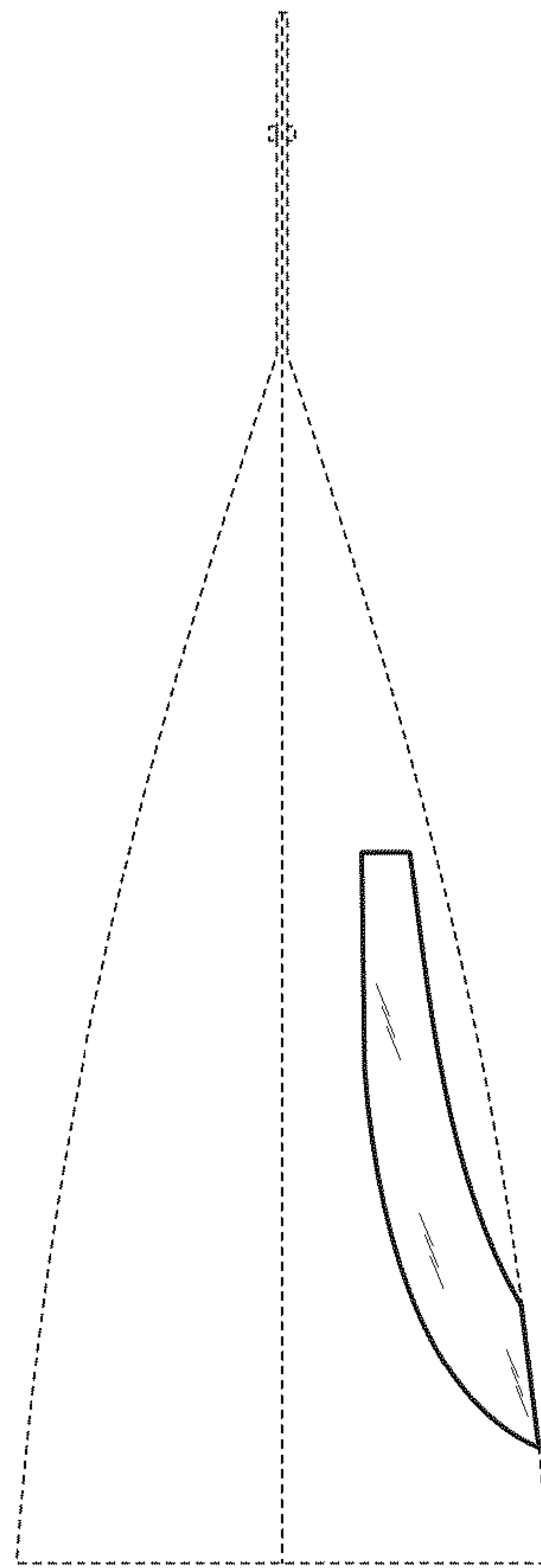


**FIG. 10**

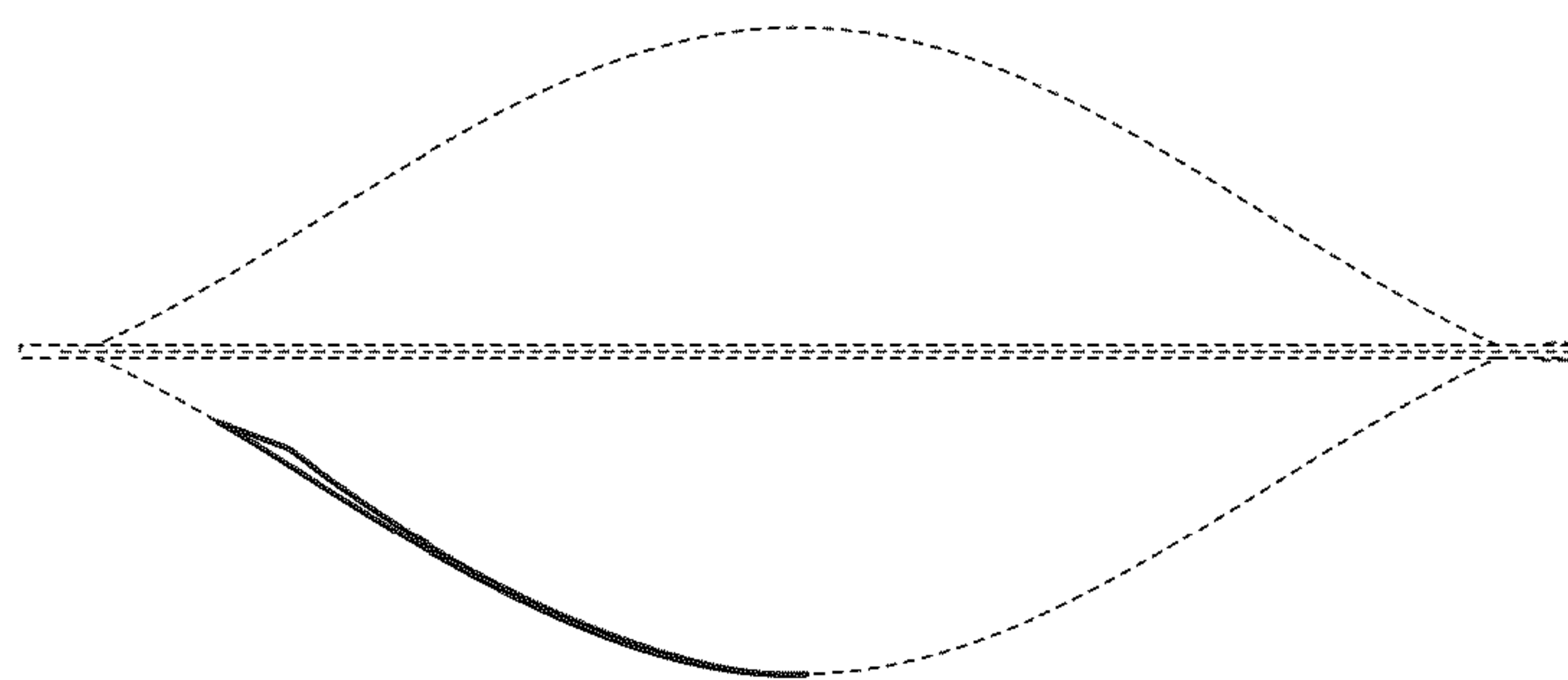




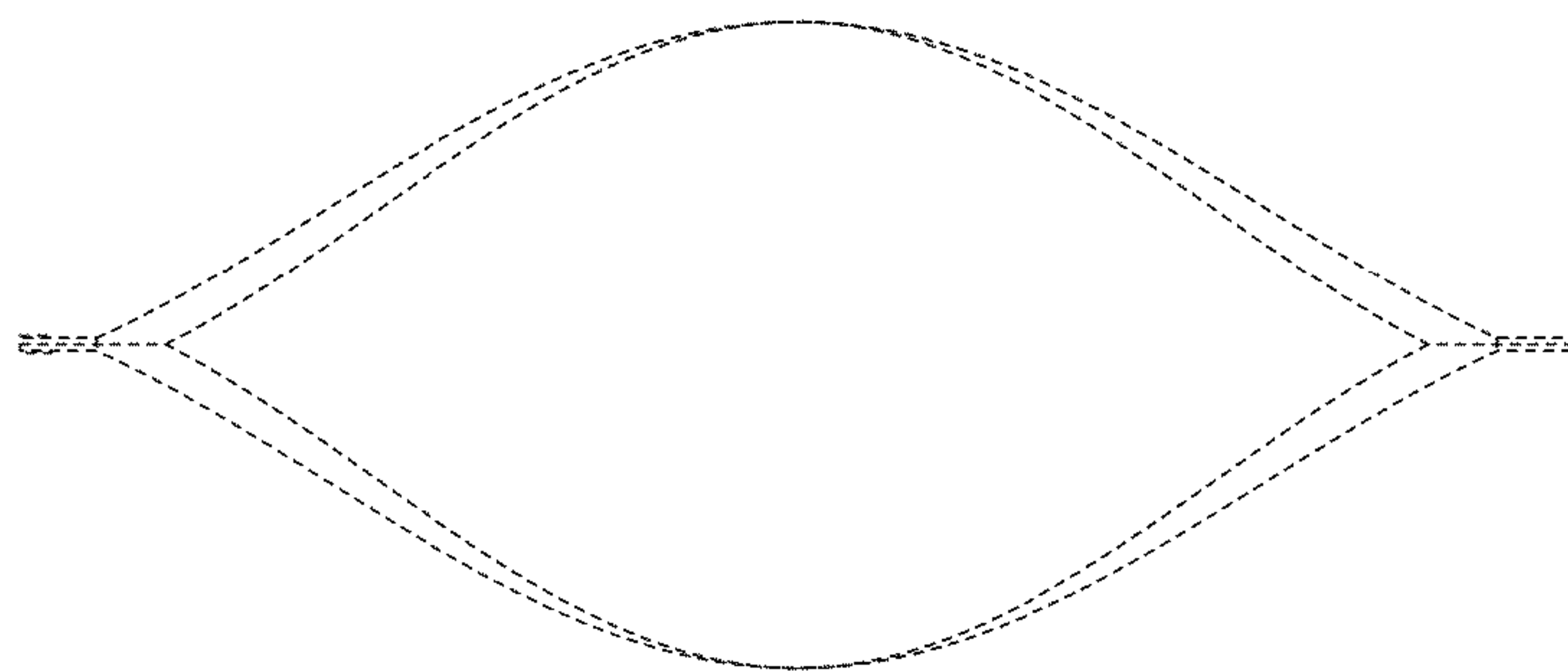
**FIG. 11**



**FIG. 12**



**FIG. 13**



**FIG. 14**