



US00D644089S

(12) **United States Design Patent**  
**Intravatola**

(10) **Patent No.:** **US D644,089 S**

(45) **Date of Patent:** **\*\* \*Aug. 30, 2011**

(54) **TELESCOPING SUPPORT**

(75) Inventor: **Lawrence Shane Intravatola**, Virginia Beach, VA (US)

(73) Assignee: **Air Systems, Inc.**, Chesapeake, VA (US)

(\*) Notice: This patent is subject to a terminal disclaimer.

(\*\*) Term: **14 Years**

(21) Appl. No.: **29/351,205**

(22) Filed: **Dec. 2, 2009**

(51) **LOC (9) Cl.** ..... **08-05**

(52) **U.S. Cl.** ..... **D8/355**

(58) **Field of Classification Search** ..... D8/354,

D8/355, 349; 248/121, 150, 156

See application file for complete search history.

(56) **References Cited**

U.S. PATENT DOCUMENTS

2,597,157 A \* 5/1952 Martino ..... 248/150

4,662,132 A \* 5/1987 Tennant ..... 52/148

D362,613 S \* 9/1995 Lott, Sr. .... D8/355

D462,889 S \* 9/2002 Wright, Sr. .... D8/355

\* cited by examiner

*Primary Examiner* — Holly H Baynham

(74) *Attorney, Agent, or Firm* — Daniel Schein, Esq.

(57) **CLAIM**

The ornamental design for a telescoping support, as shown and described.

**DESCRIPTION**

FIG. 1 is a top-front-outside perspective view of a preferred embodiment of a telescoping support, the telescoping support shown in a contracted configuration.

FIG. 2 is a bottom-front-outside perspective view of the telescoping support in FIG. 1, the telescoping support shown in a partially extended configuration.

FIG. 3 is a top-rear-inside perspective view of the telescoping support in FIG. 1, the telescoping support shown in a contracted configuration.

FIG. 4 is a bottom-rear-inside perspective view of the telescoping support in FIG. 1, the telescoping support shown in a partially extended configuration.

FIG. 5 is a top-front-outside perspective view of a preferred embodiment of the telescoping support in FIG. 1, the telescoping support shown in a contracted configuration.

FIG. 6 is a top-front-outside perspective view of a preferred embodiment of the telescoping support in FIG. 1, the telescoping support shown in an extended configuration.

FIG. 7 is a top-rear-inside perspective view of the telescoping support in FIG. 1; and,

FIG. 8 is a top-rear-inside perspective view of a preferred embodiment of the telescoping support in FIG. 1, the telescoping support shown in an extended configuration.

**1 Claim, 8 Drawing Sheets**

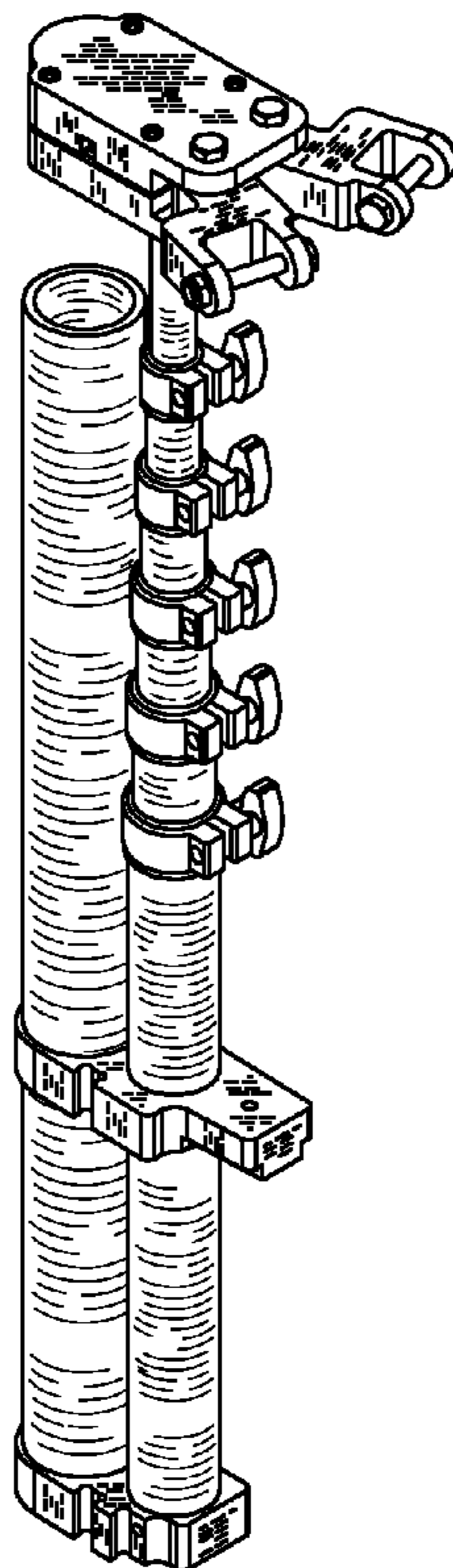

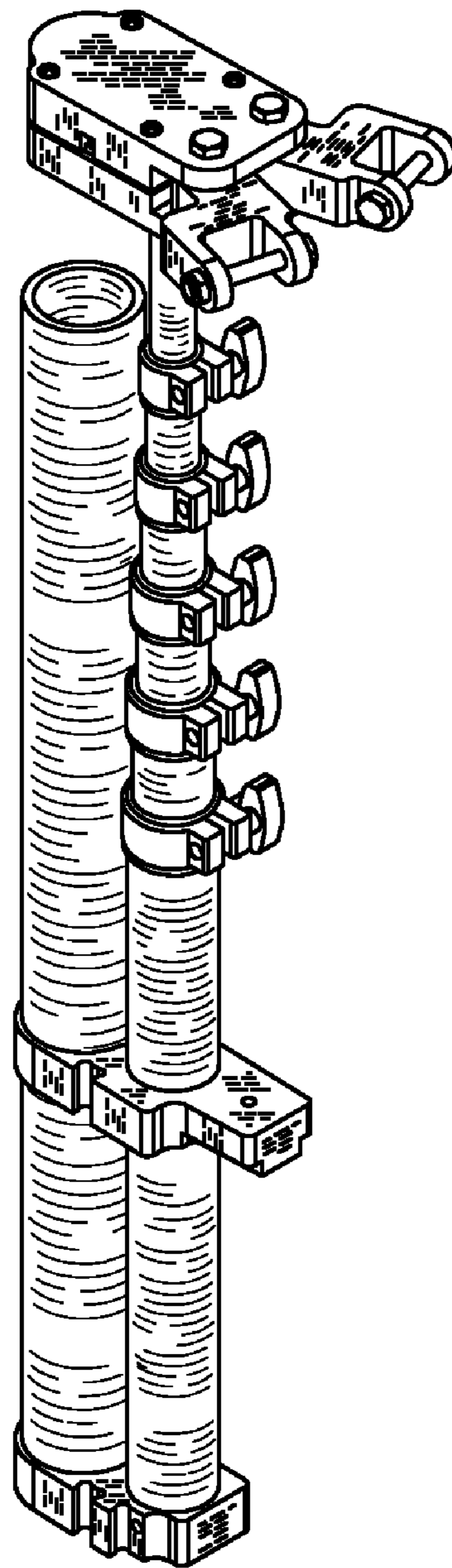

FIG. 1

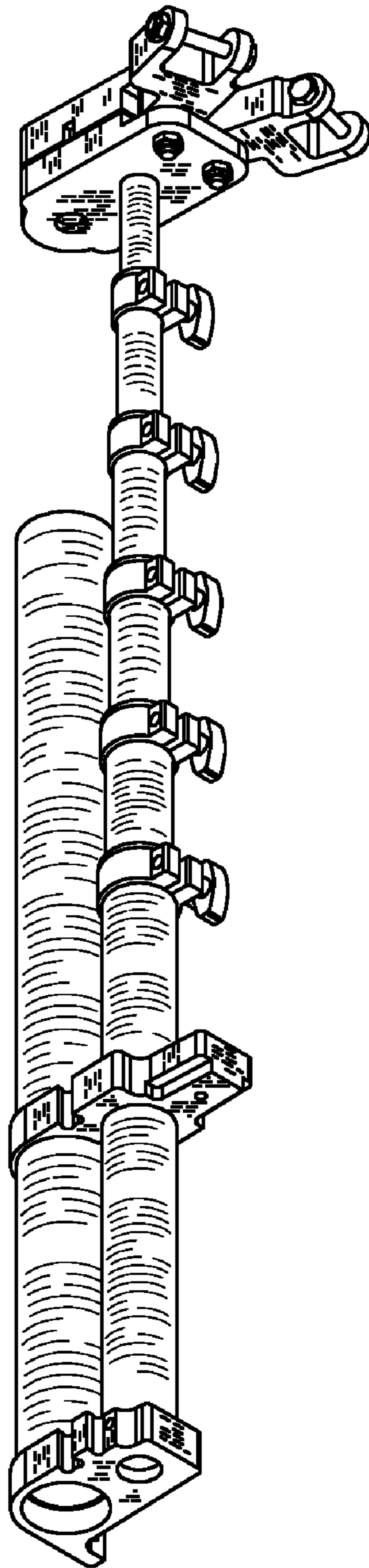

FIG. 2

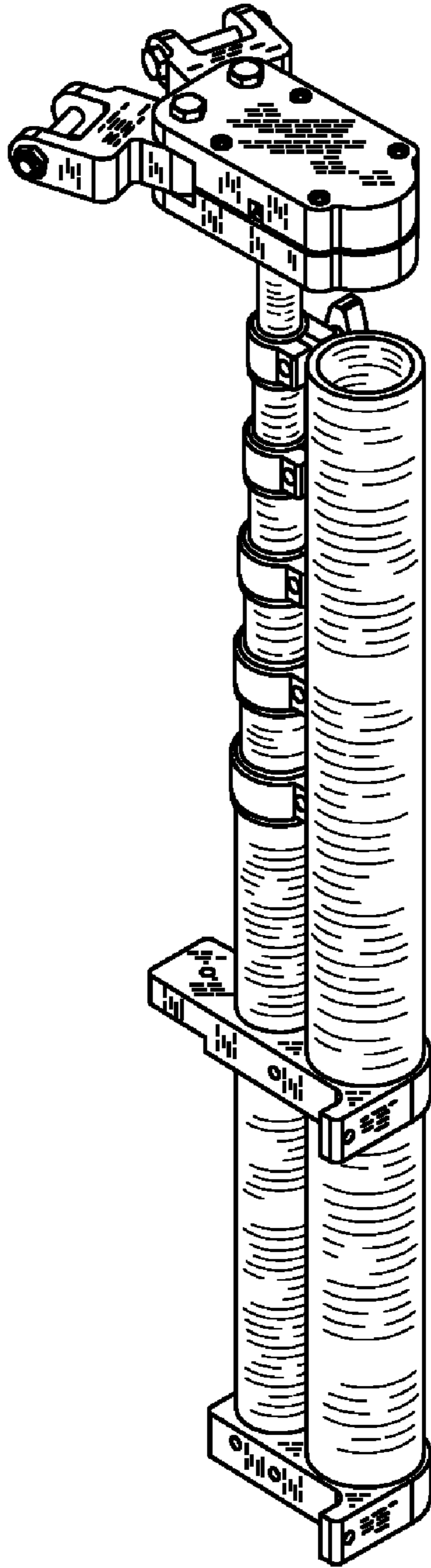

FIG. 3

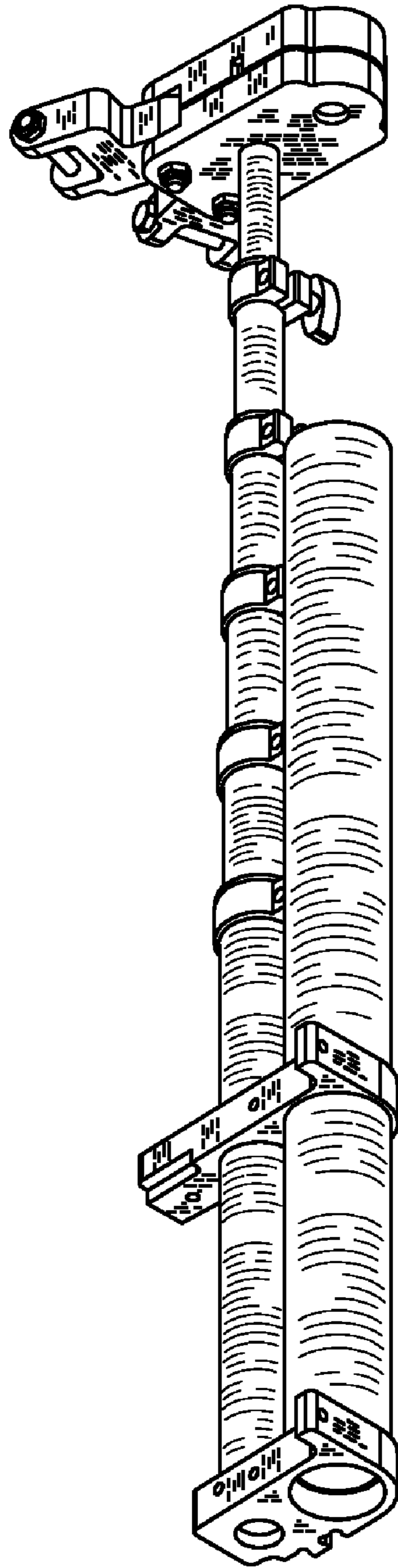

FIG. 4

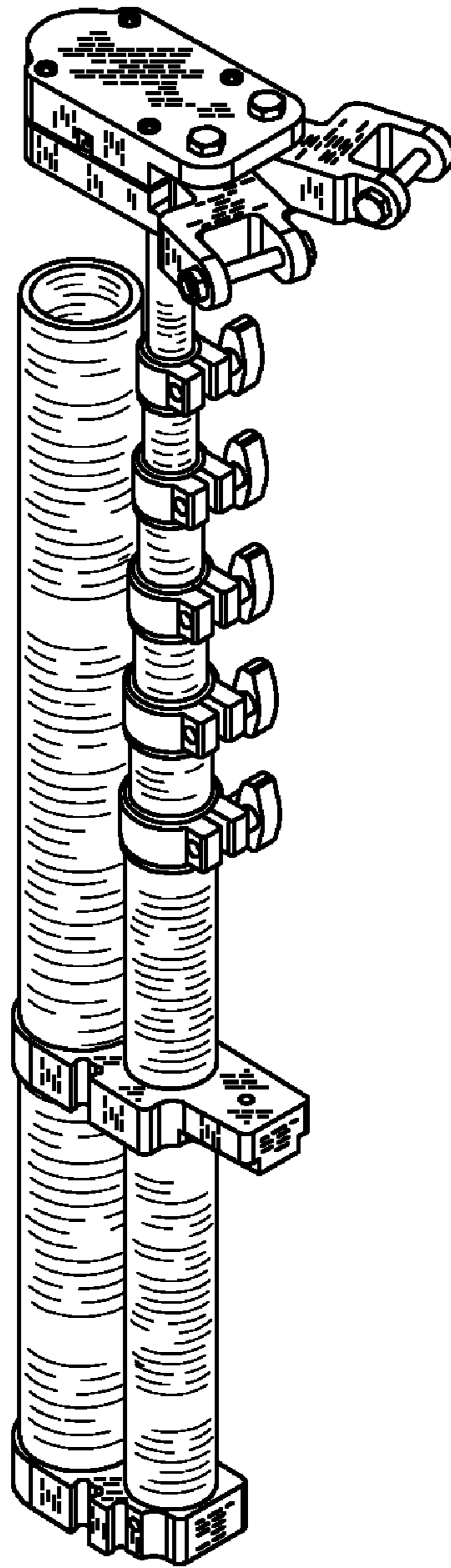

FIG. 5

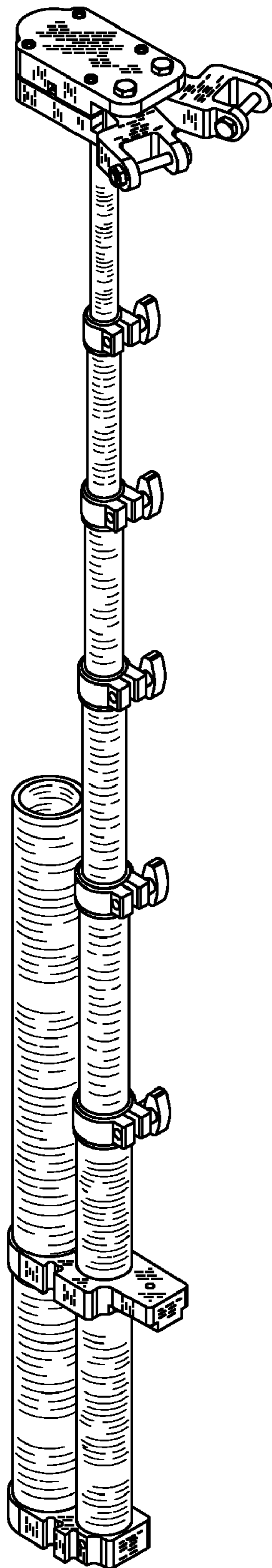

FIG. 6

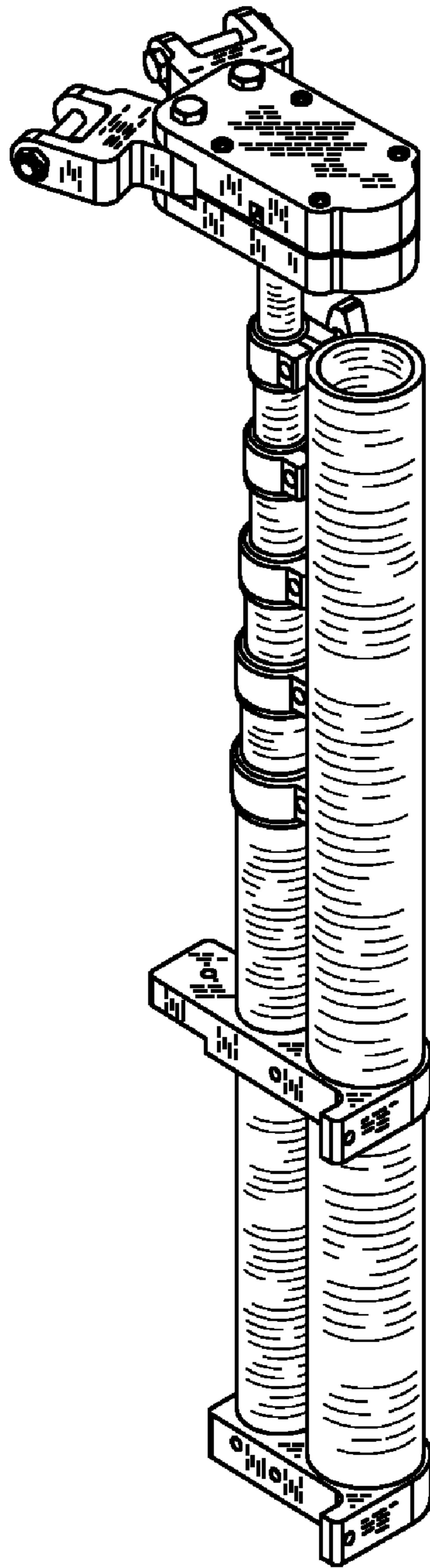

FIG. 7



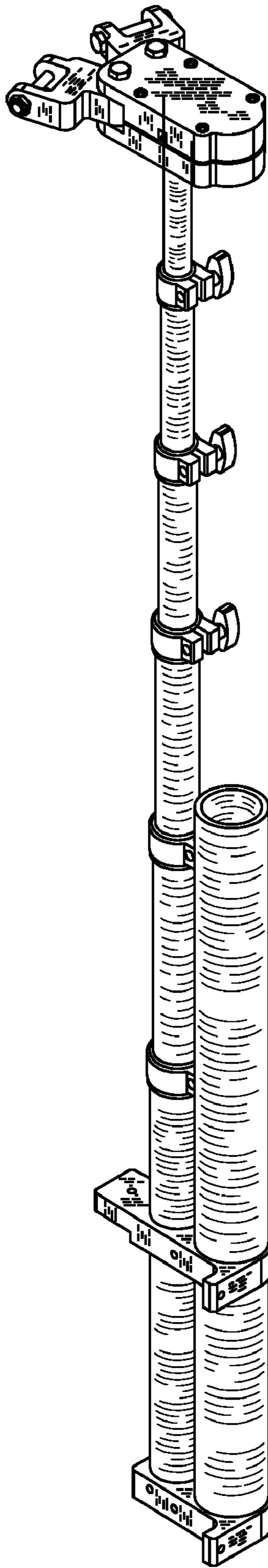

FIG. 8