



US00D643875S

(12) **United States Design Patent**
Suzuki et al.

(10) **Patent No.:** **US D643,875 S**

(45) **Date of Patent:** **** Aug. 23, 2011**

(54) **PRINTER**

(75) Inventors: **Wataru Suzuki**, Shiojiri (JP); **Tomoko Iwasaki**, Shiojiri (JP); **Hiromi Shishiuchi**, Shiojiri (JP); **Hiroaki Fukumoto**, Shiojiri (JP)

(73) Assignee: **Seiko Epson Corporation**, Tokyo (JP)

(**) Term: **14 Years**

(21) Appl. No.: **29/369,673**

(22) Filed: **Sep. 10, 2010**

(30) **Foreign Application Priority Data**

Jun. 30, 2010 (JP) 2010-016002

(51) **LOC (9) Cl.** **14-02**

(52) **U.S. Cl.** **D18/55**

(58) **Field of Classification Search** D18/19,
D18/36-37, 50, 54-54.1, 55; D14/420-425,
D14/463-470; 400/613, 613.1-613.4, 690,
400/690.1-690.4, 691-694

See application file for complete search history.

(56) **References Cited**

U.S. PATENT DOCUMENTS

D276,340	S	*	11/1984	Takeuchi et al.	D14/470
D307,439	S	*	4/1990	Doi	D18/55
D322,451	S	*	12/1991	McClelland et al.	D18/55
D322,802	S	*	12/1991	Hara	D18/55
D348,899	S	*	7/1994	Masujima et al.	D18/55
D350,343	S	*	9/1994	Saito et al.	D14/422
D354,981	S	*	1/1995	Kobayashi et al.	D18/54
D369,181	S	*	4/1996	Kobayashi	D18/55
D516,120	S	*	2/2006	Yamano et al.	D18/55

* cited by examiner

Primary Examiner — Cathy A MacCormac

(74) *Attorney, Agent, or Firm* — Workman Nydegger

(57) **CLAIM**

The ornamental design for a printer, as shown and described.

DESCRIPTION

FIG. 1 is a perspective view of our new design for a printer, as viewed from the top front and right side; FIG. 2 is a front view of the printer shown in FIG. 1; FIG. 3 is a rear view of the printer shown in FIG. 1; FIG. 4 is a left side view of the printer shown in FIG. 1; FIG. 5 is a right side view of the printer shown in FIG. 1; FIG. 6 is a top view of the printer shown in FIG. 1; and, FIG. 7 is a bottom view of the printer shown in FIG. 1. The broken lines shown in the figures are for illustrative purposes only and form no part of the claimed design.

1 Claim, 4 Drawing Sheets

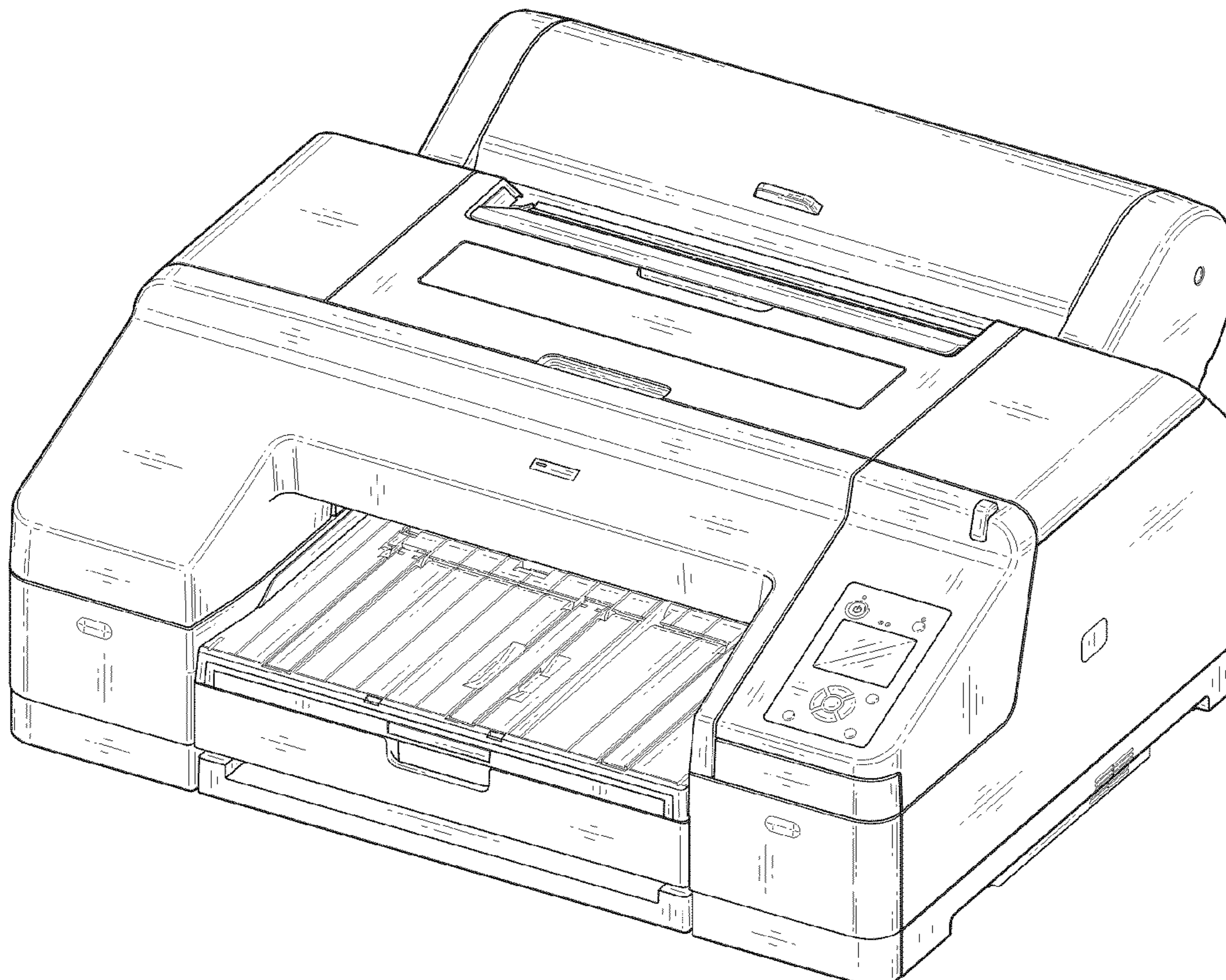

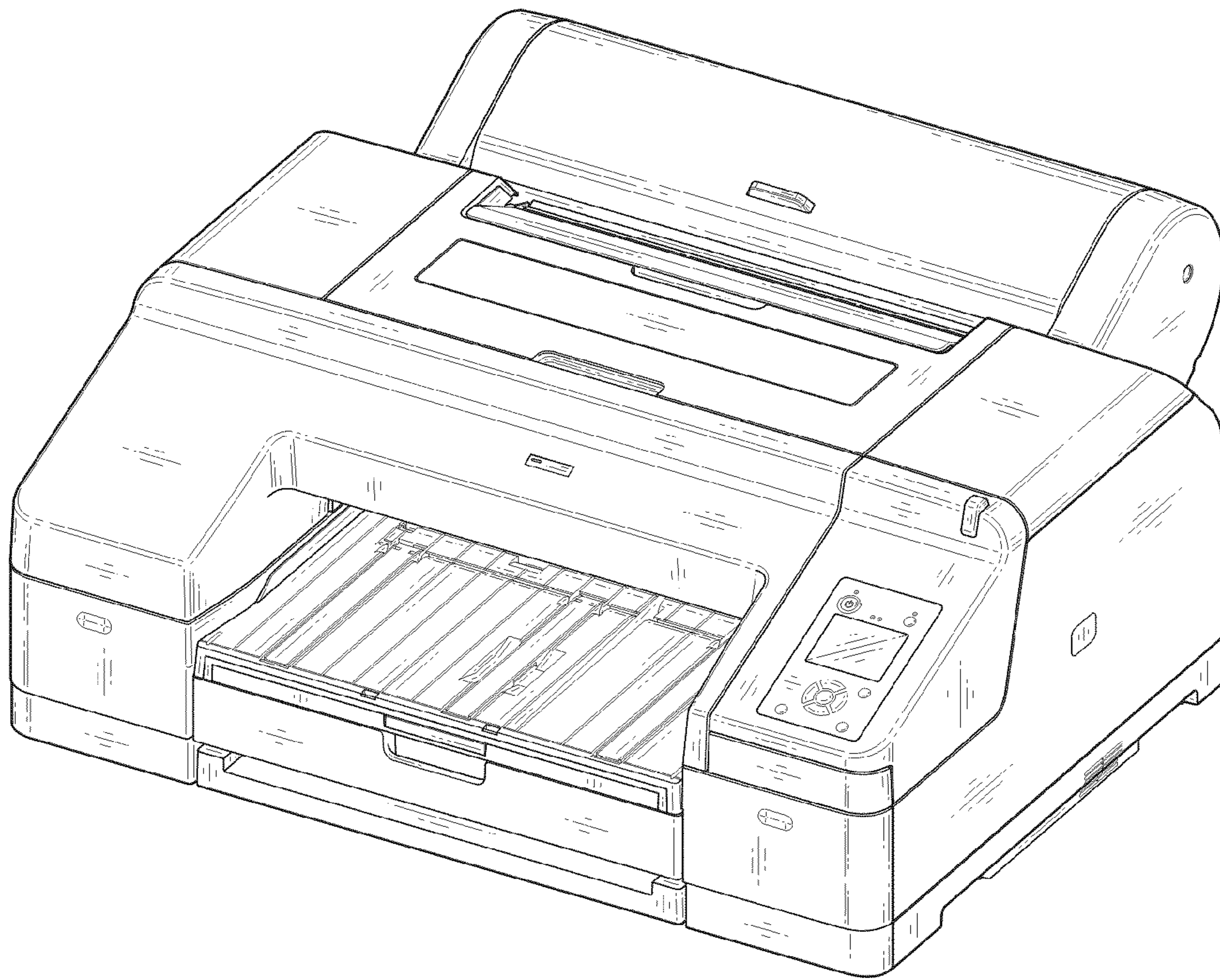

FIG. 1

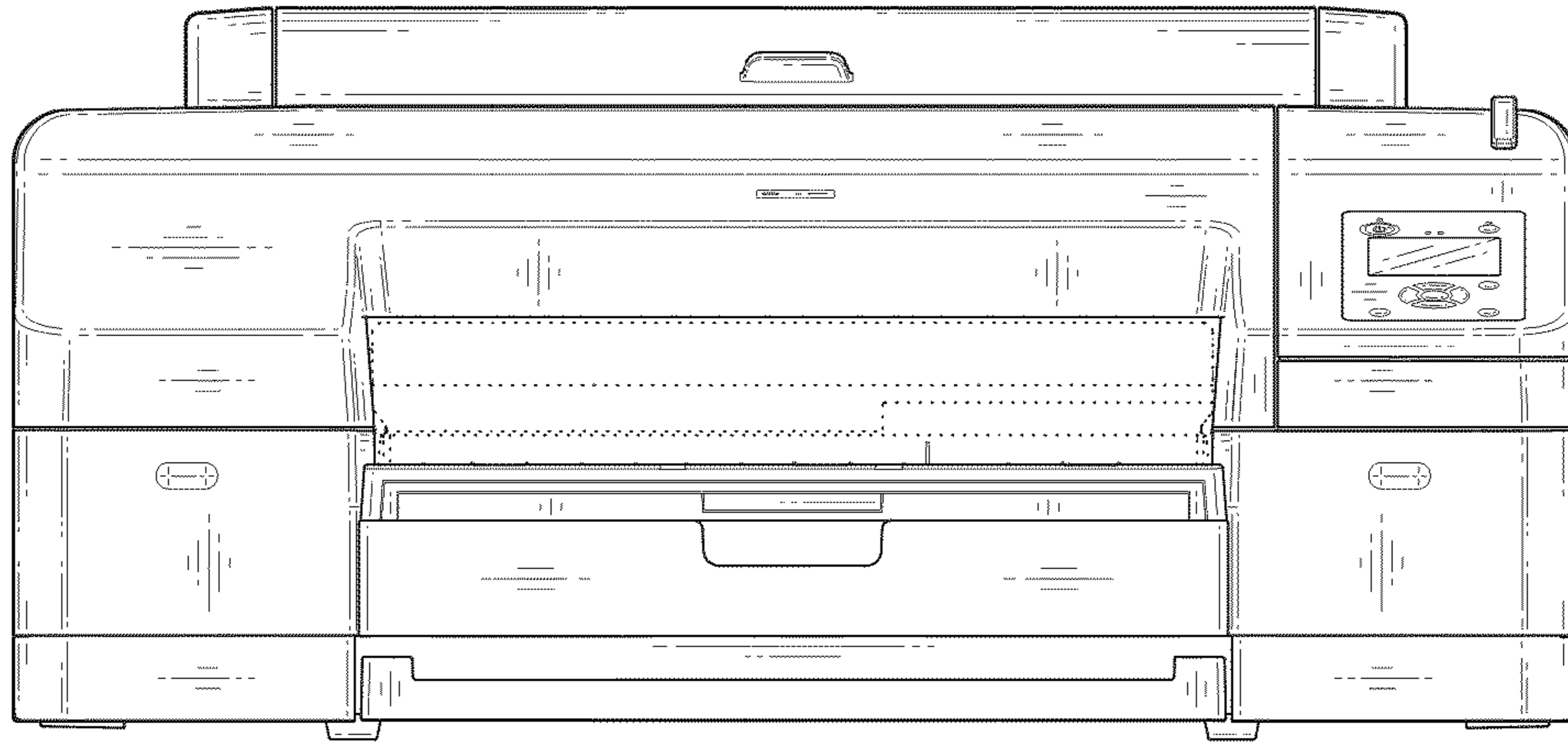

FIG. 2

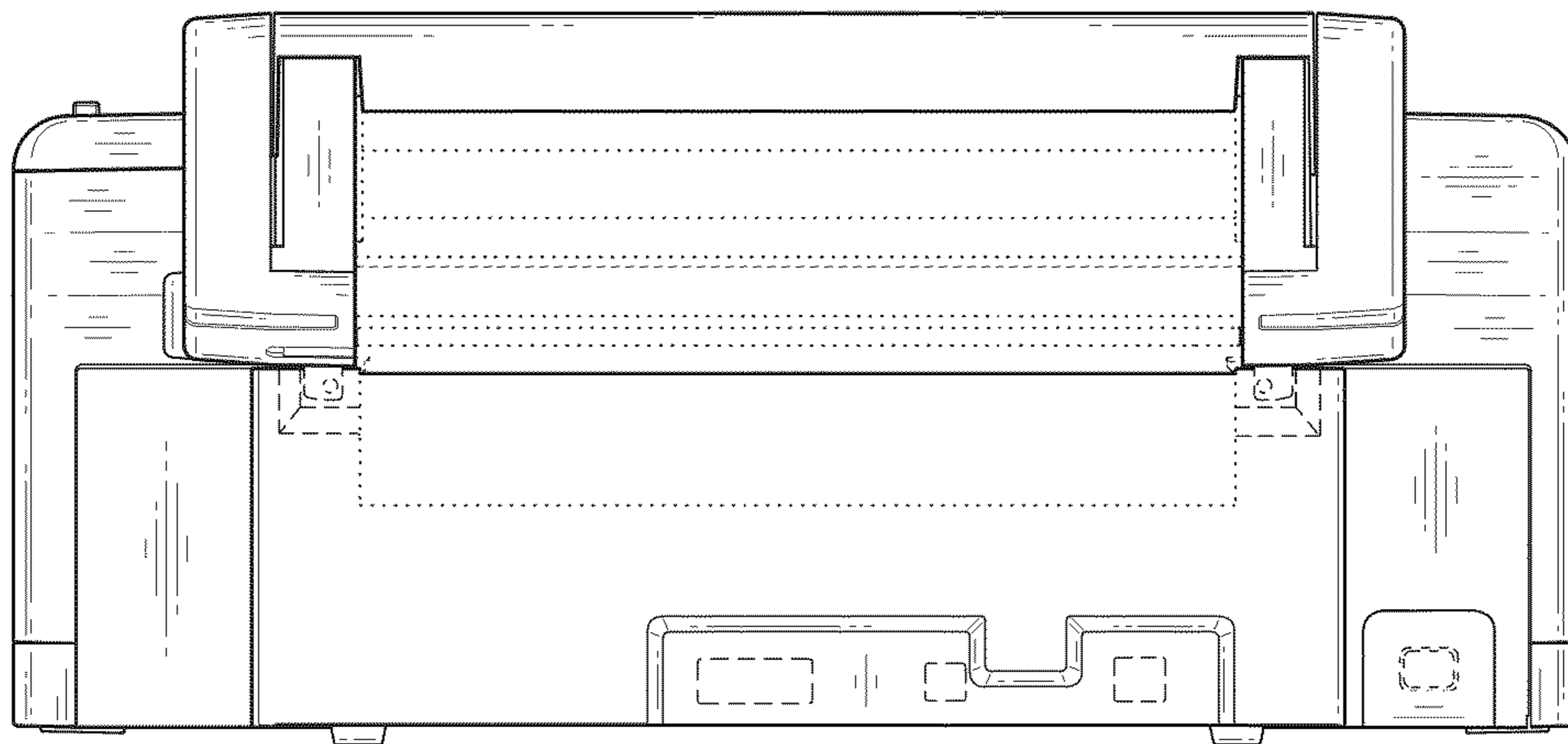

FIG. 3

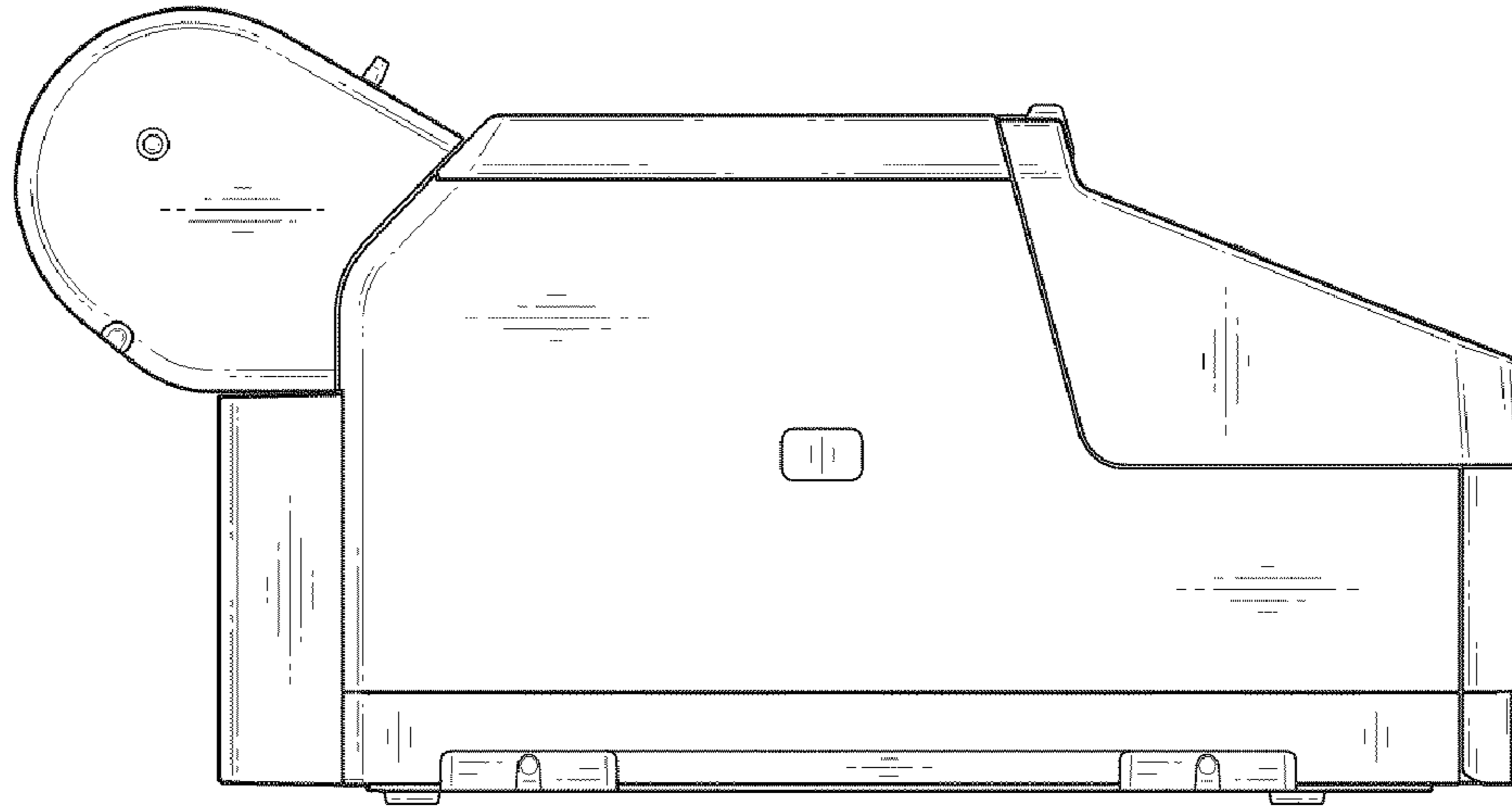

FIG. 4

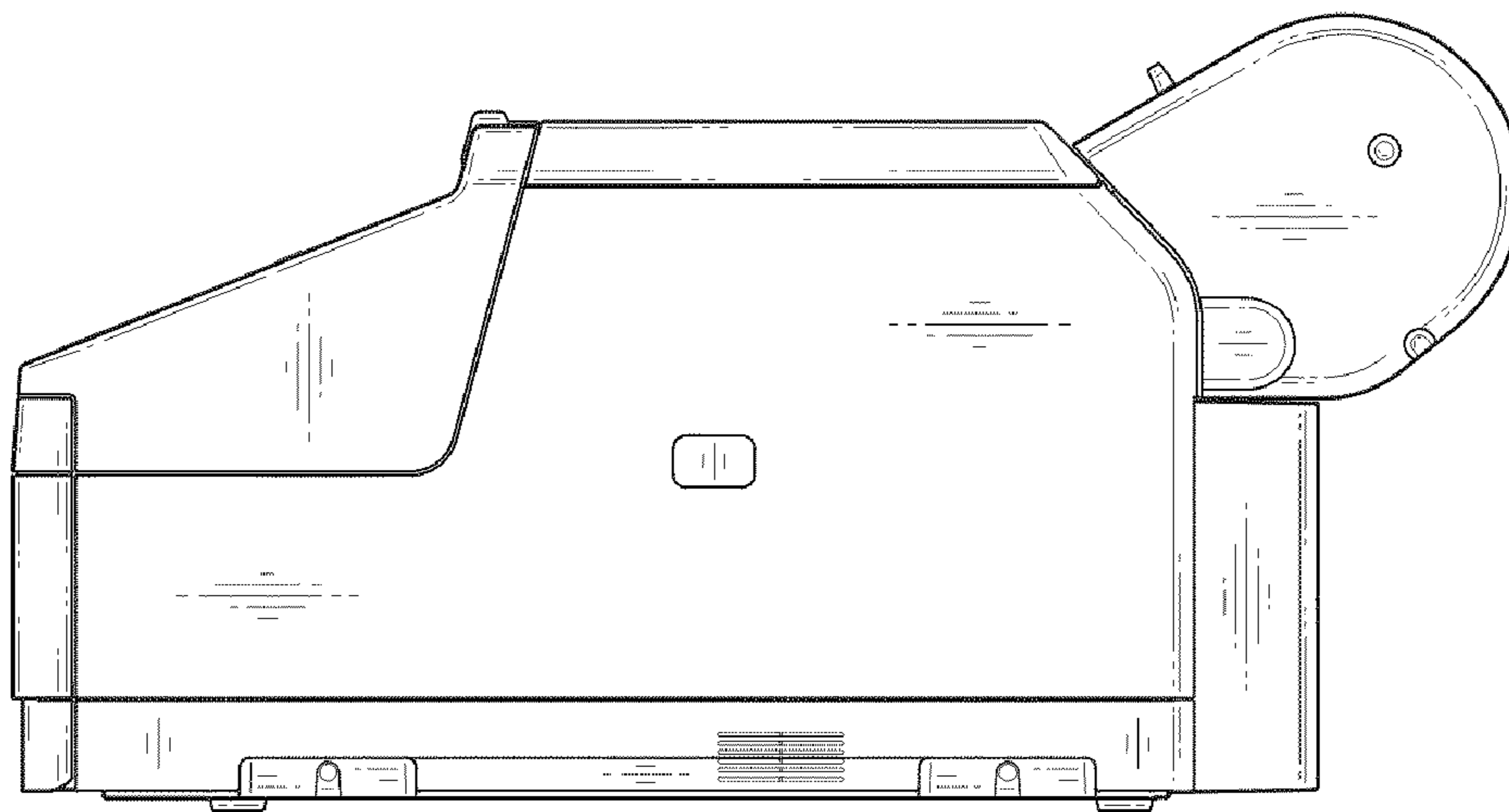

FIG. 5

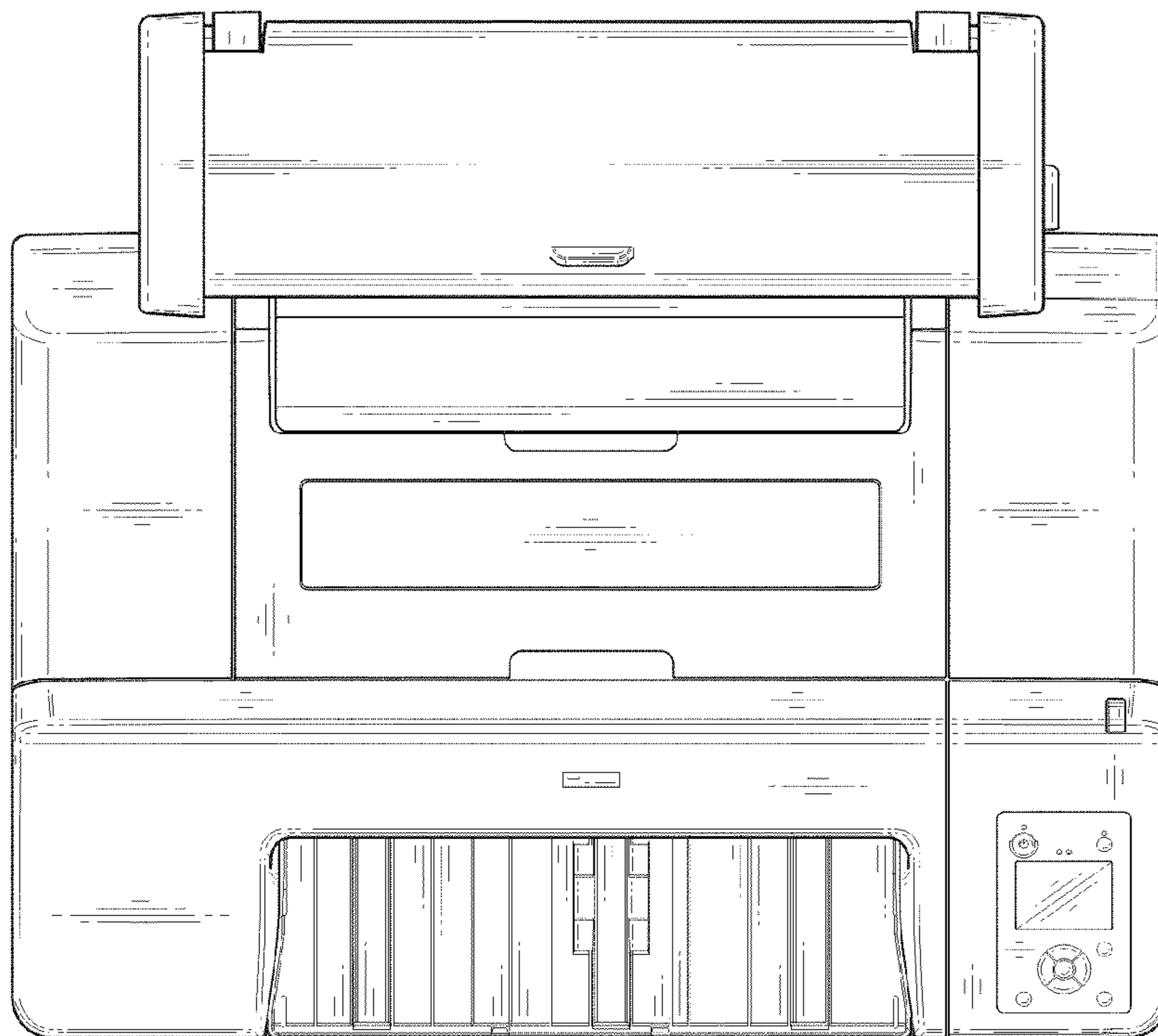

FIG. 6

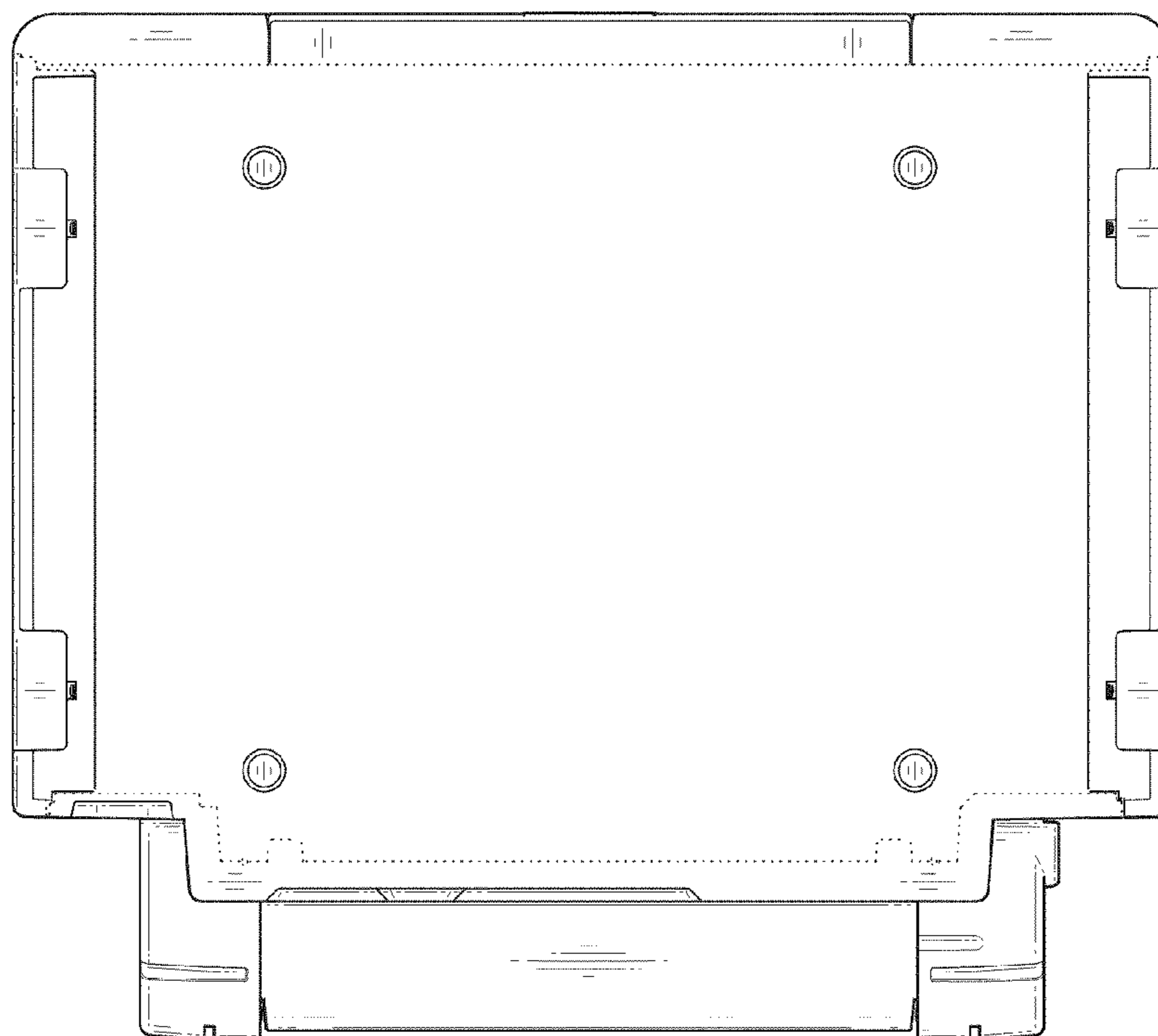

FIG. 7