



US00D643776S

(12) **United States Design Patent**
Keyaki et al.

(10) **Patent No.:** **US D643,776 S**

(45) **Date of Patent:** **** Aug. 23, 2011**

(54) **SLIDER FOR SLIDE FASTENER**

(75) Inventors: **Keiichi Keyaki**, Toyama-Ken (JP);
Yohei Miyazaki, Toyama-ken (JP)

(73) Assignee: **YKK Corporation** (JP)

(**) Term: **14 Years**

(21) Appl. No.: **29/377,428**

(22) Filed: **Oct. 21, 2010**

(30) **Foreign Application Priority Data**

Apr. 22, 2010 (JP) 2010-010136

(51) **LOC (9) Cl.** **02-07**

(52) **U.S. Cl.** **D11/221**

(58) **Field of Classification Search** D11/200,
D11/201, 221; 24/381-383, 385-387, 414-417,
24/421-422, 427-431, 433; 2/265

See application file for complete search history.

(56) **References Cited**

U.S. PATENT DOCUMENTS

D291,671 S * 9/1987 Keyaki D11/221
D608,247 S * 1/2010 Keyaki et al. D11/221

* cited by examiner

Primary Examiner — Ralf Seifert

(74) *Attorney, Agent, or Firm* — Kilpatrick Townsend &
Stockton LLP

(57) **CLAIM**

The ornamental design for a slider for slide fastener, as shown
and described.

DESCRIPTION

FIG. 1 is a perspective view of the bottom, front and right of
a slider for slide fastener showing our new design;
FIG. 2 is a front view thereof;
FIG. 3 is a rear view thereof;
FIG. 4 is a top plan view thereof;
FIG. 5 is a bottom view of the buckle; and,
FIG. 6 is a right side view of the buckle, the left side view
being mirror image thereof.

1 Claim, 3 Drawing Sheets

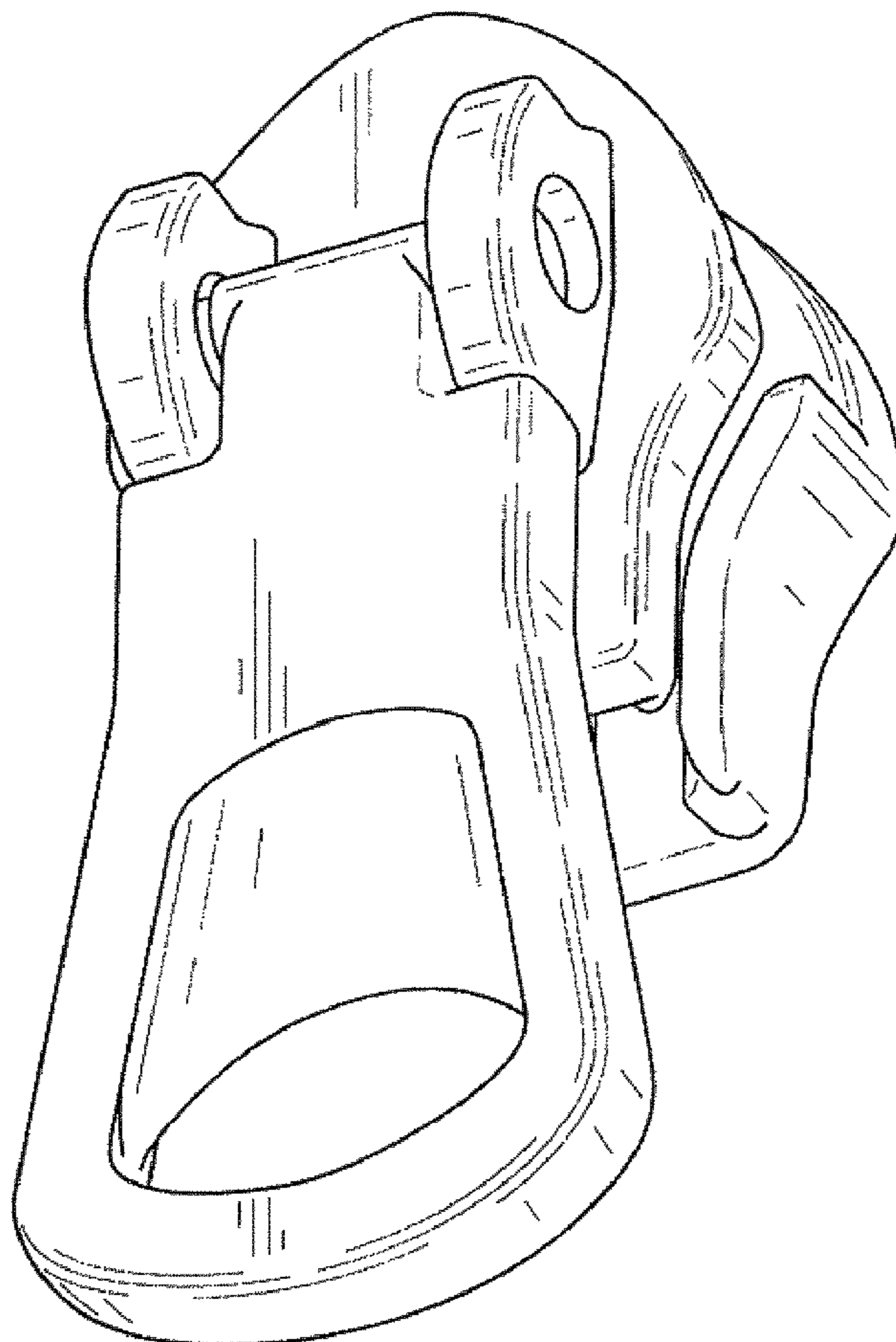

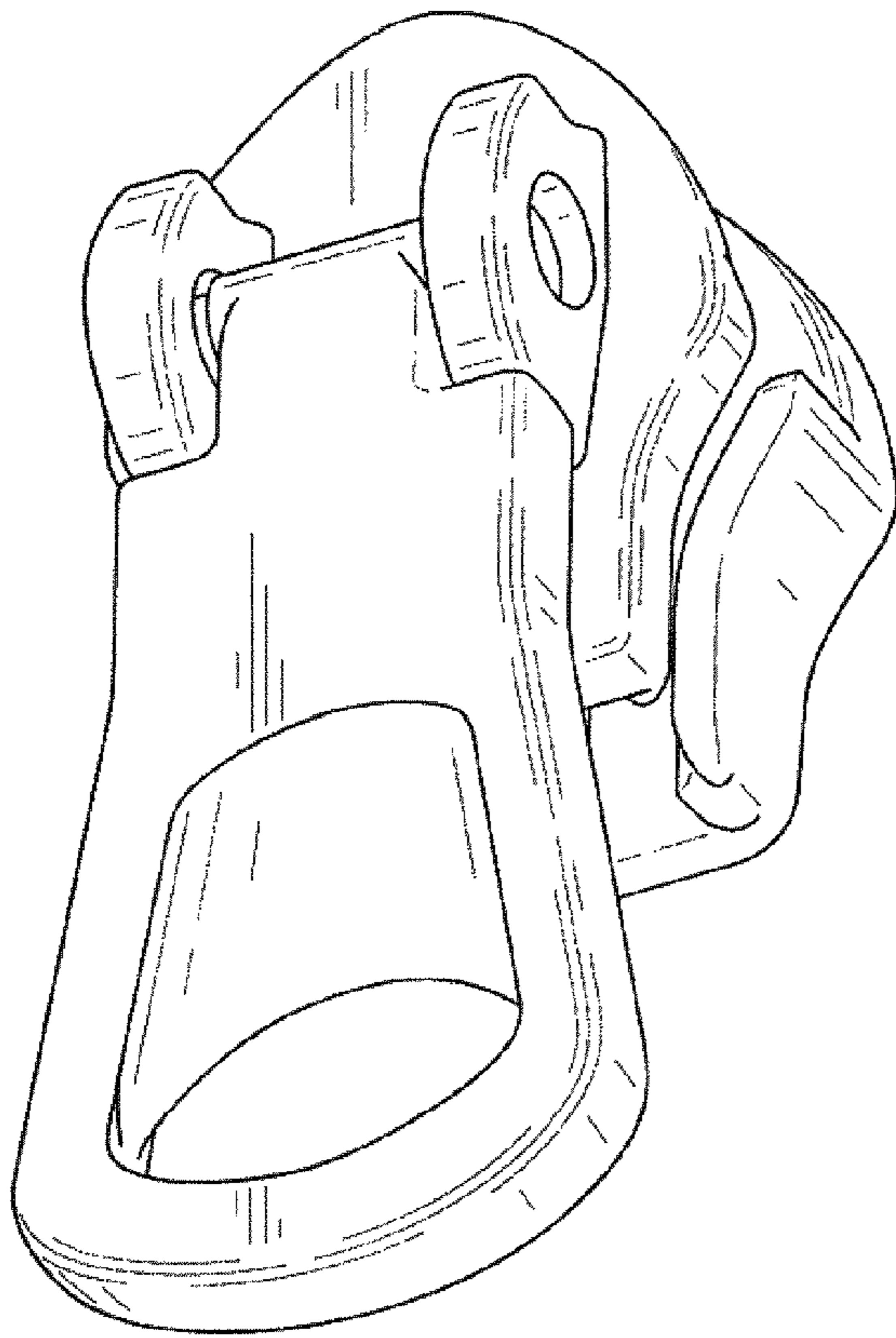

FIG. 1

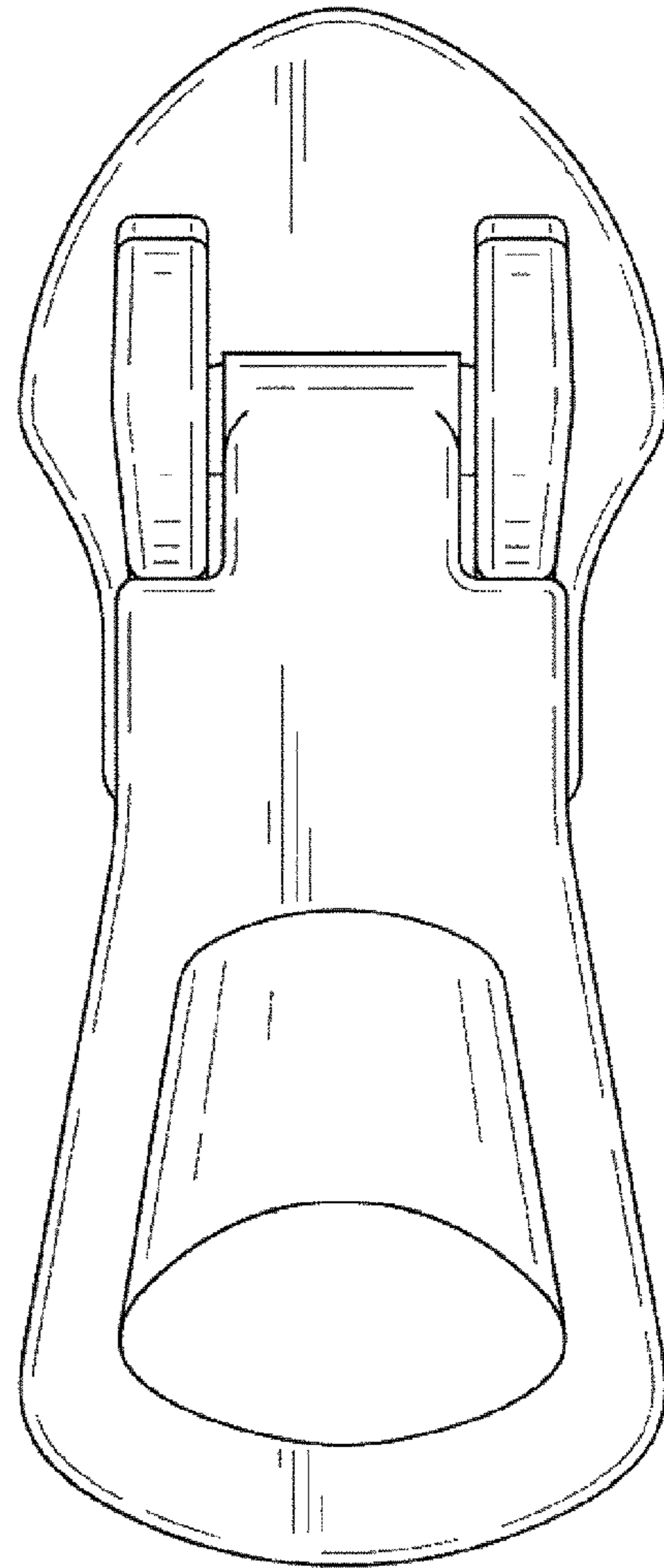

FIG. 2

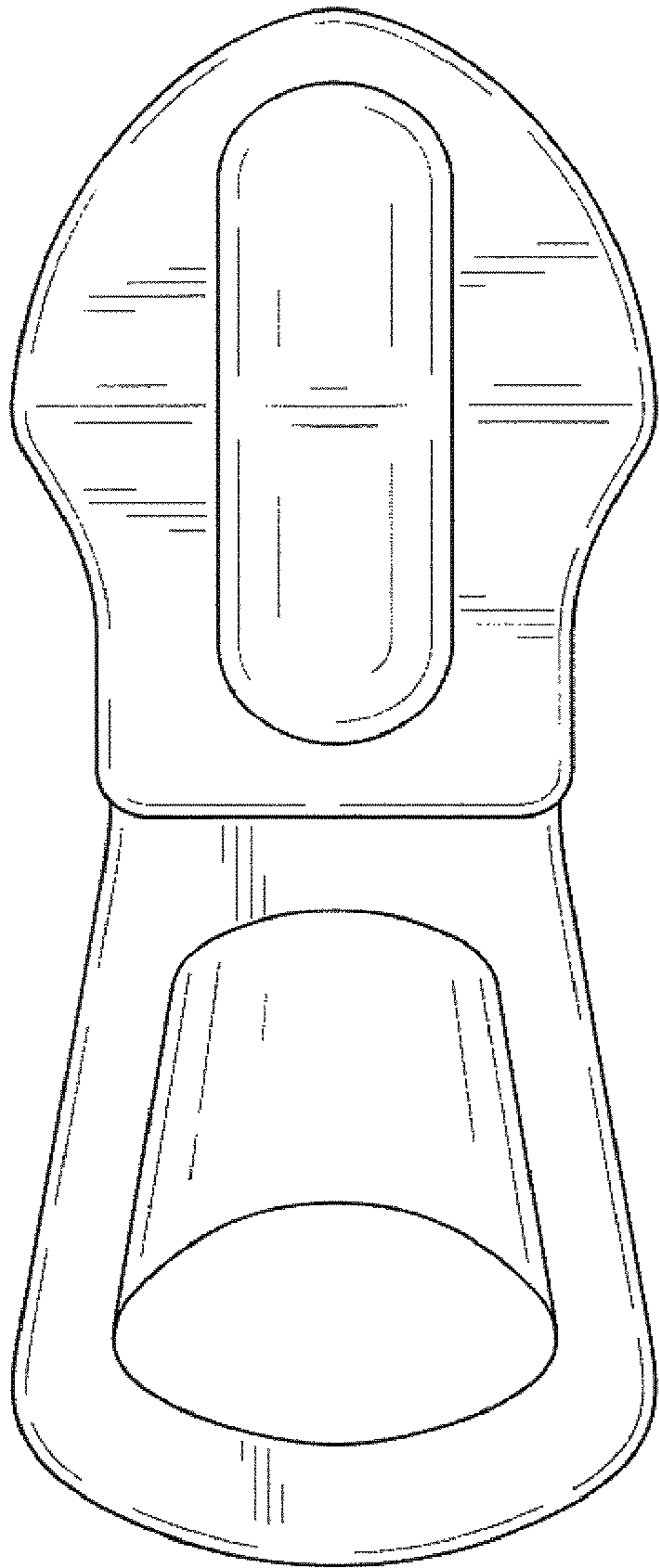

FIG. 3

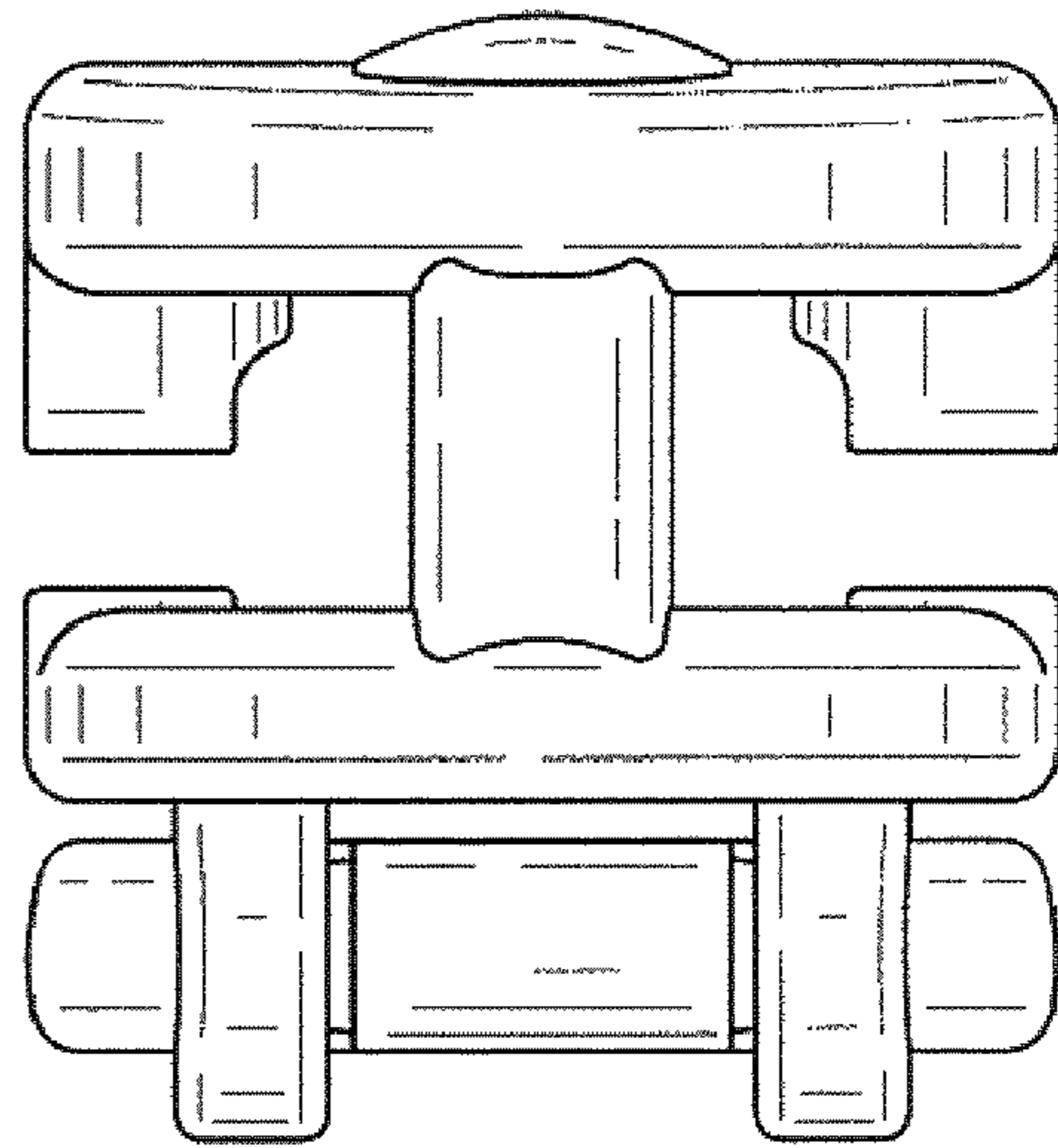

FIG. 4

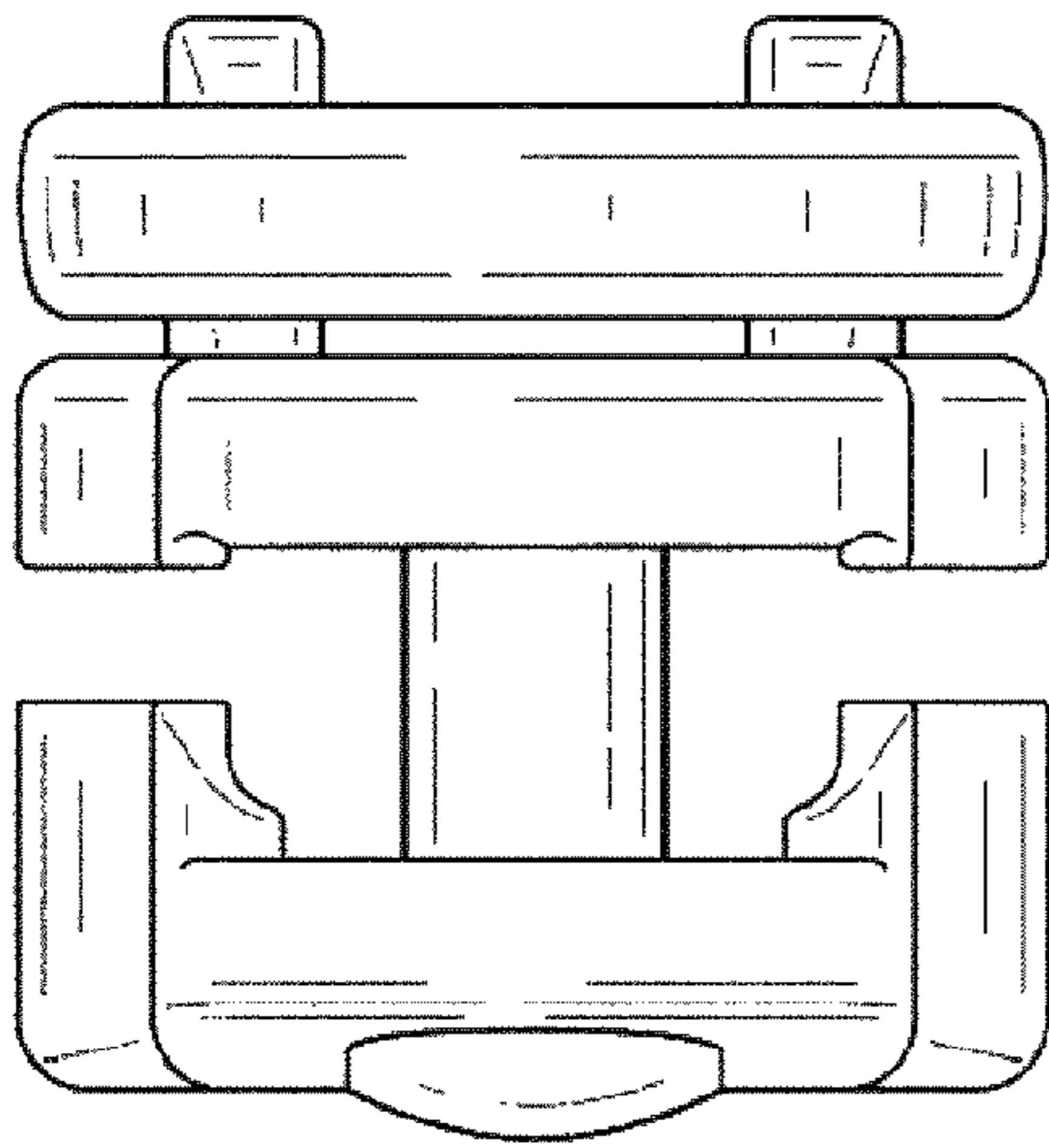

FIG. 5

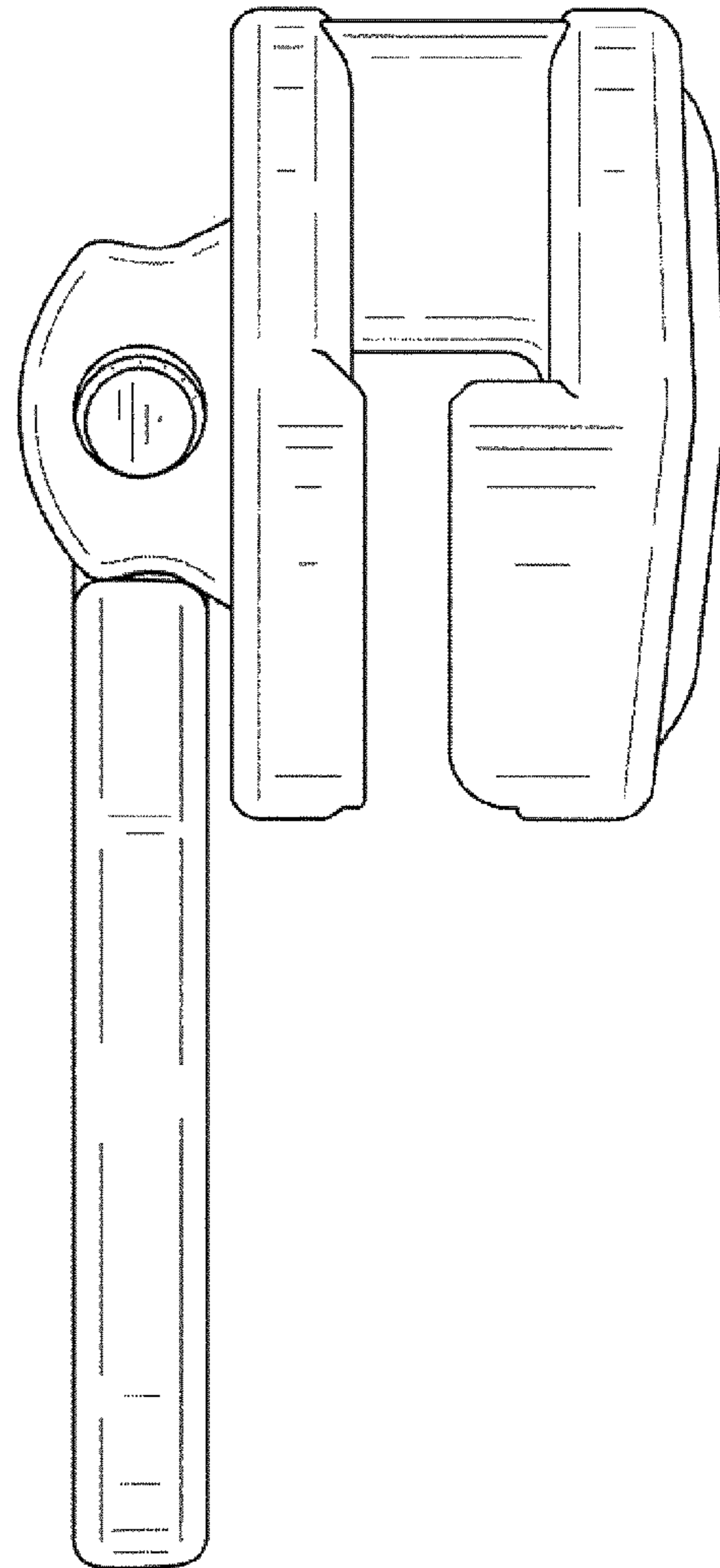

FIG. 6