



US00D643739S

(12) **United States Design Patent**
Schmertz, Jr. et al.

(10) **Patent No.:** **US D643,739 S**

(45) **Date of Patent:** **** Aug. 23, 2011**

(54) **BOTTLE**

(75) Inventors: **William Schmertz, Jr.**, Memphis, TN (US); **Jonathan Lee**, Milford, CT (US); **James Troy Starkey**, North Haven, CT (US); **John K. Clay**, Milford, CT (US); **Javier Verdura**, Milford, CT (US)

(73) Assignee: **Schering-Plough Healthcare Products, Inc.**, Memphis, TN (US)

(**) Term: **14 Years**

(21) Appl. No.: **29/338,175**

(22) Filed: **Jun. 5, 2009**

(51) **LOC (9) Cl.** **09-01**

(52) **U.S. Cl.** **D9/565**

(58) **Field of Classification Search** D9/723-726,
D9/516-575, 682-694, 434-436, 453, 600-681;
215/379, 381, 382; 220/669-675

See application file for complete search history.

(56) **References Cited**

U.S. PATENT DOCUMENTS

D232,521 S	8/1974	Roche	D9/542
D240,968 S	8/1976	Hurst	D24/197
D268,896 S	5/1983	Sledge	D9/549
D290,934 S	7/1987	Rader	D9/573
4,936,490 A *	6/1990	Battegazzore	222/205
5,050,757 A *	9/1991	Hidding et al.	220/23,83
D325,164 S	4/1992	Cann et al.	D9/529
D325,167 S	4/1992	Humfress	D9/575
D325,343 S	4/1992	Pisar	D9/549
D332,751 S	1/1993	Pischulti et al.	D9/560
D351,761 S	10/1994	Feer	D7/510
D360,134 S	7/1995	Snyder	D9/520
5,803,287 A *	9/1998	Kusz	215/330
D429,629 S	8/2000	Kuzma et al.	D9/682
D447,059 S	8/2001	Vette	D9/549
D498,146 S	11/2004	Densky et al.	D9/571

(Continued)

FOREIGN PATENT DOCUMENTS

GB DES. 2058402 12/1996

(Continued)

Primary Examiner — Catherine Tuttle

(74) *Attorney, Agent, or Firm* — Matthew J. Golden

(57) **CLAIM**

The ornamental design for a bottle, as shown and described.

DESCRIPTION

A portion of the disclosure of this patent document contains material which is subject to copyright protection. The copyright owner has no objection to the facsimile reproduction by anyone of the patent document or the patent disclosure, as it appears in the Patent and Trademark Office patent file or records, but reserves all other copyright rights whatsoever.

FIG. 1 is a front view of a bottle showing my/our new design;

FIG. 2 is a rear view thereof;

FIG. 3 is a right view thereof;

FIG. 4 is a left view thereof;

FIG. 5 is a top view thereof;

FIG. 6 is a bottom view thereof;

FIG. 7 is a front view of a second embodiment thereof;

FIG. 8 is a rear view thereof;

FIG. 9 is a right view thereof;

FIG. 10 is a left view thereof;

FIG. 11 is a top view thereof;

FIG. 12 is a bottom view thereof;

FIG. 13 is a front view of a third embodiment thereof;

FIG. 14 is a rear view thereof;

FIG. 15 is a right view thereof;

FIG. 16 is a left view thereof;

FIG. 17 is a top view thereof;

FIG. 18 is a bottom view thereof;

FIG. 19 is a front view of a fourth embodiment thereof;

FIG. 20 is a rear view thereof;

FIG. 21 is a right view thereof;

FIG. 22 is a left view thereof;

FIG. 23 is a top view thereof; and,

FIG. 24 is a bottom view thereof.

The broken lines are included for the purpose of illustrating portions of the bottle that form no part of the claim to the embodiment in which they are shown.

1 Claim, 18 Drawing Sheets

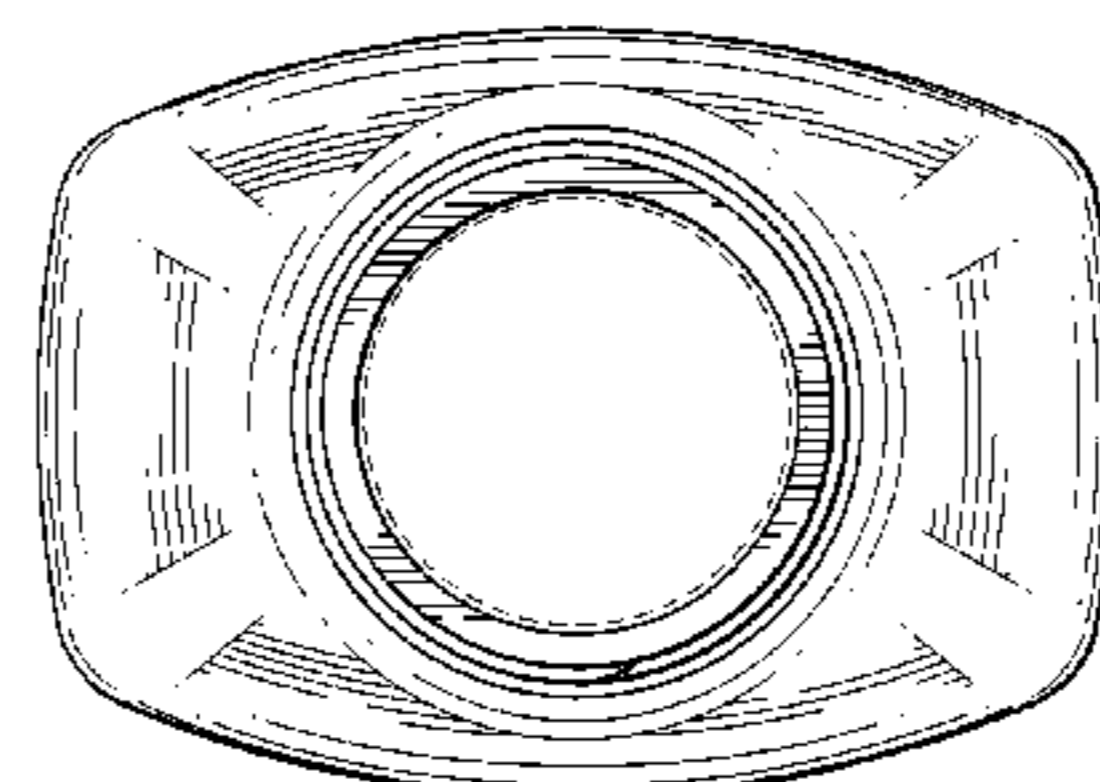
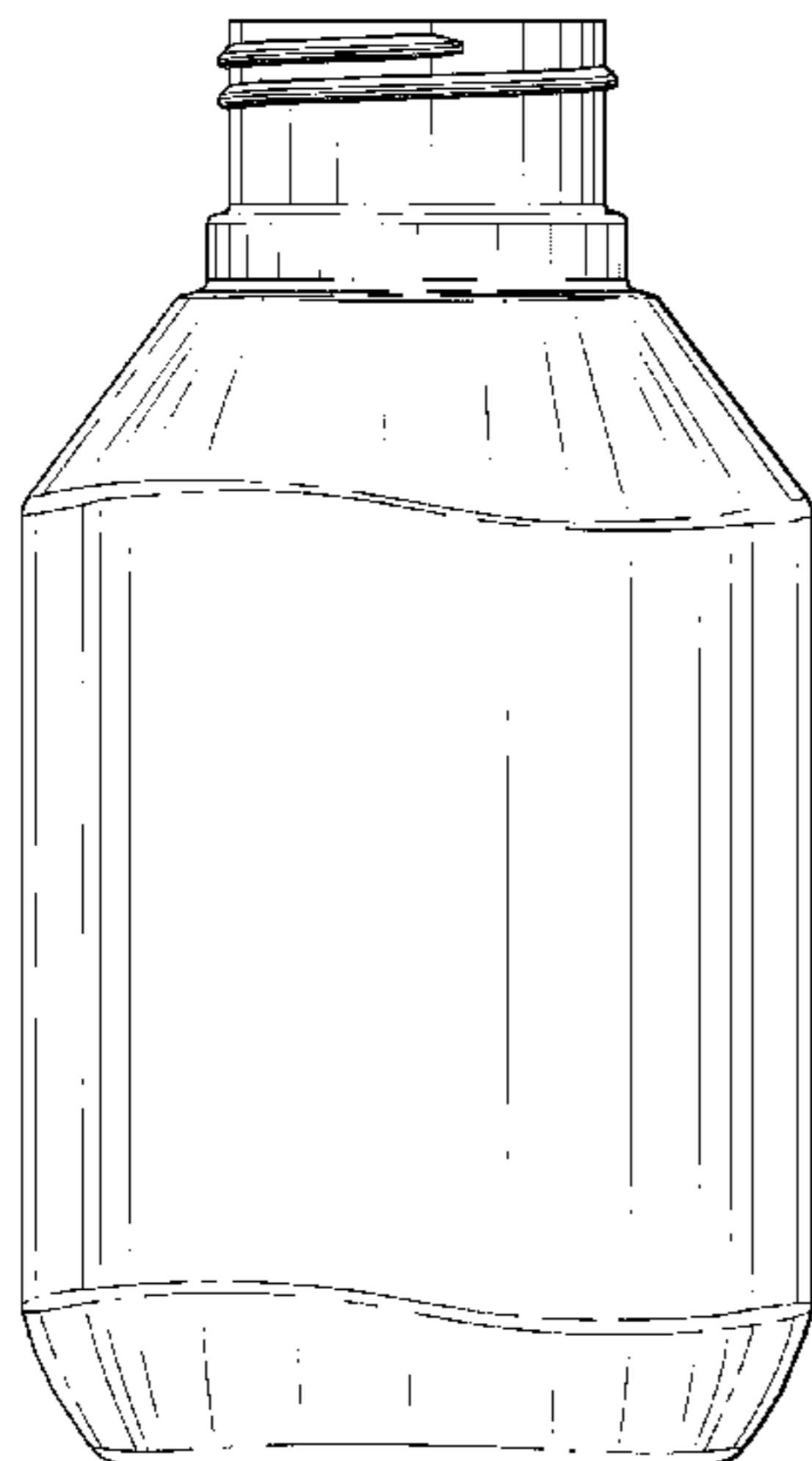

US D643,739 S

Page 2

U.S. PATENT DOCUMENTS

D523,756 S * 6/2006 Considine et al. D9/573
D535,566 S * 1/2007 Lin D9/560
D539,651 S * 4/2007 Snyder D9/520
D558,583 S * 1/2008 Langbein et al. D9/560

FOREIGN PATENT DOCUMENTS

GB DES. 2058403 12/1996
WO DM/050613 2/2000
* cited by examiner

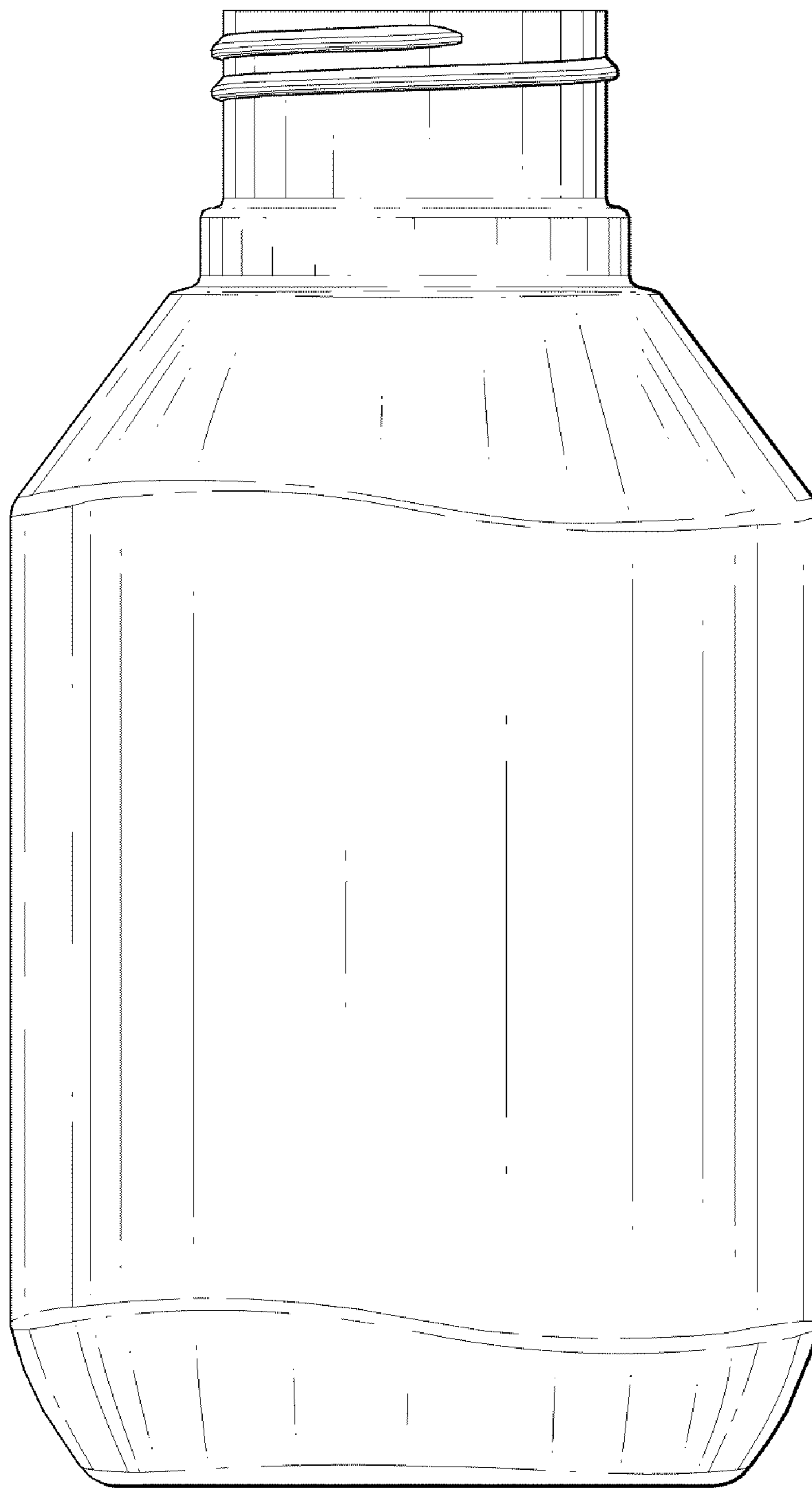

FIG. 1

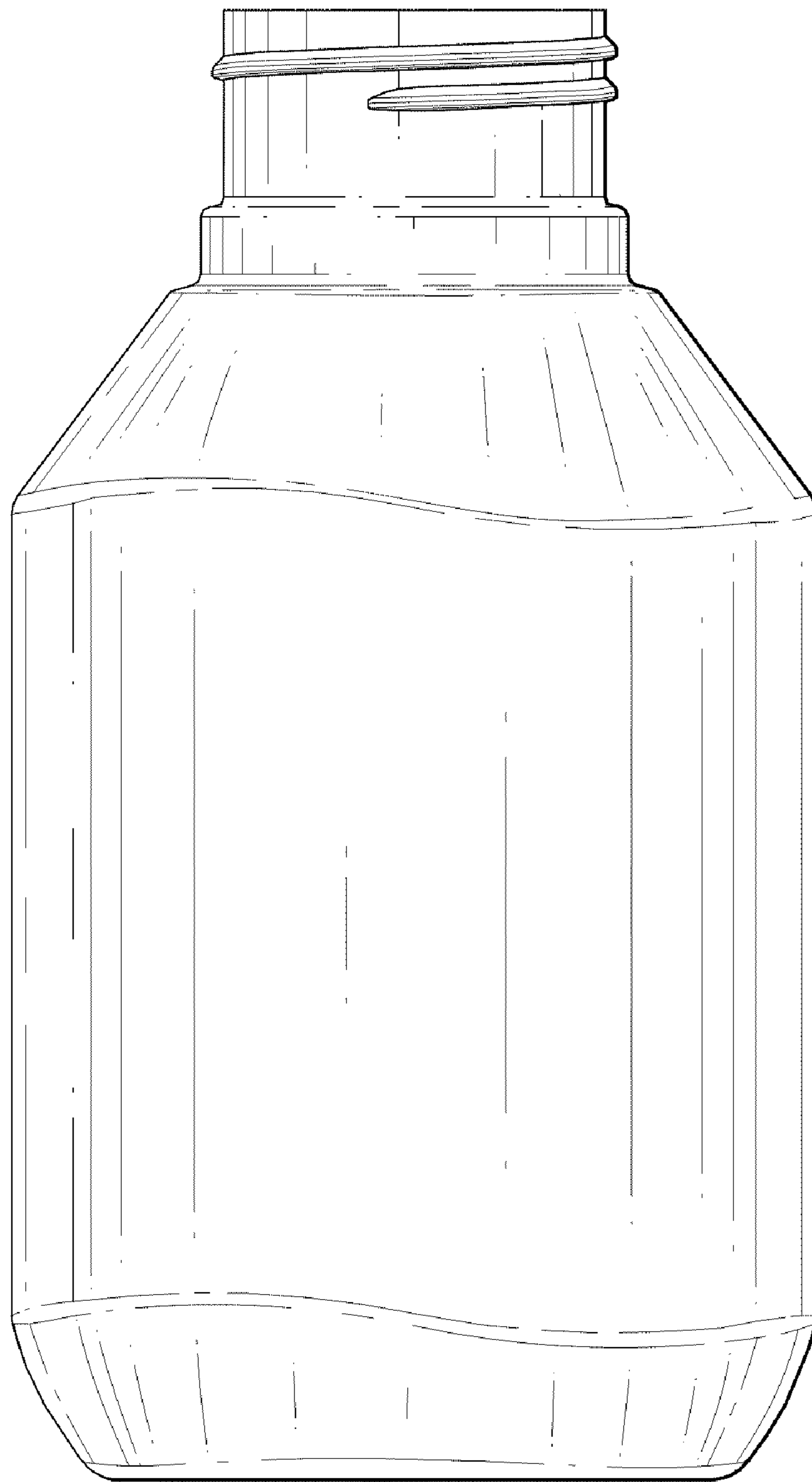

FIG. 2

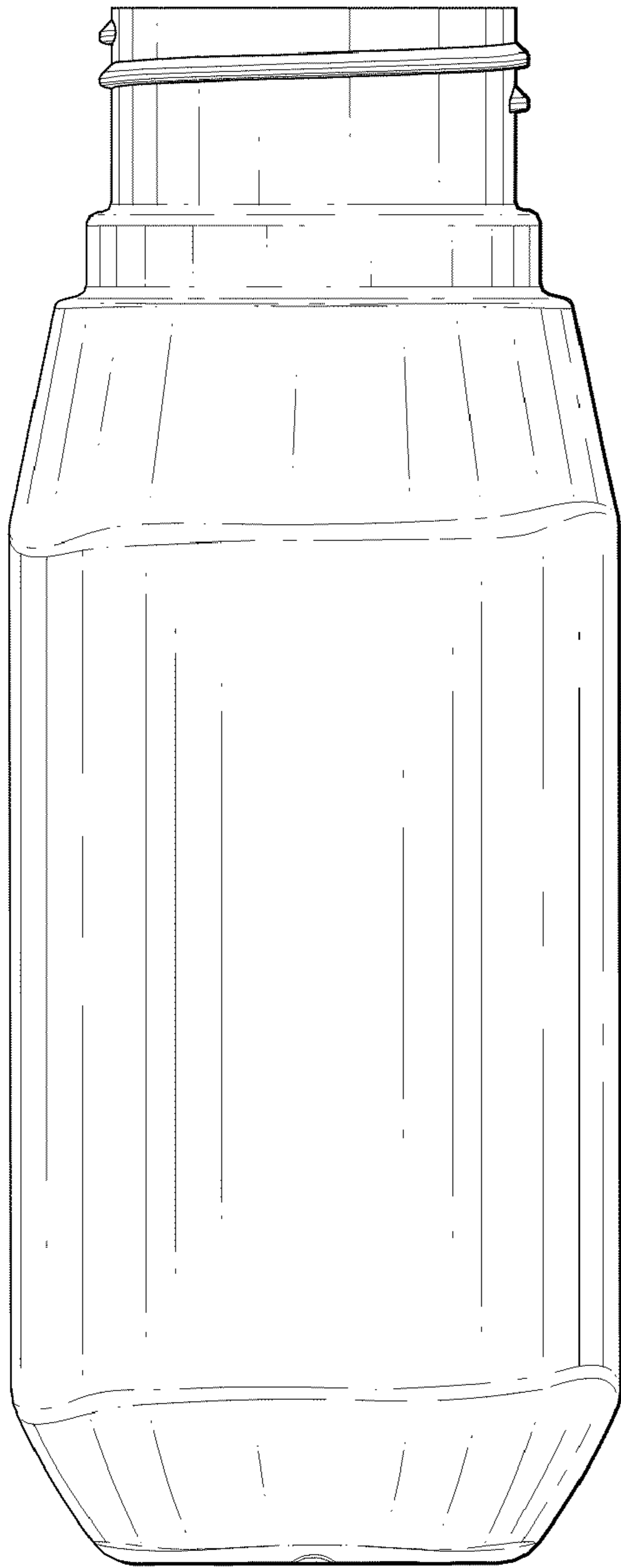

FIG. 3

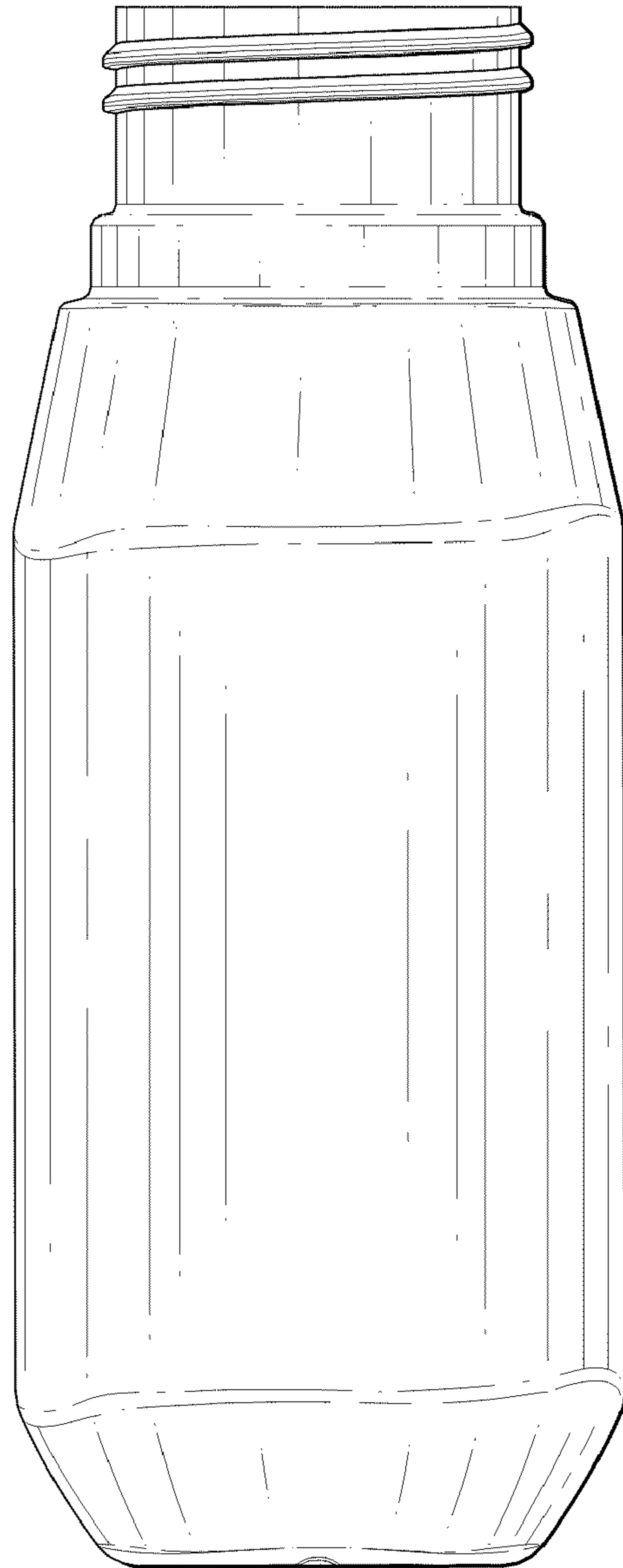

FIG. 4

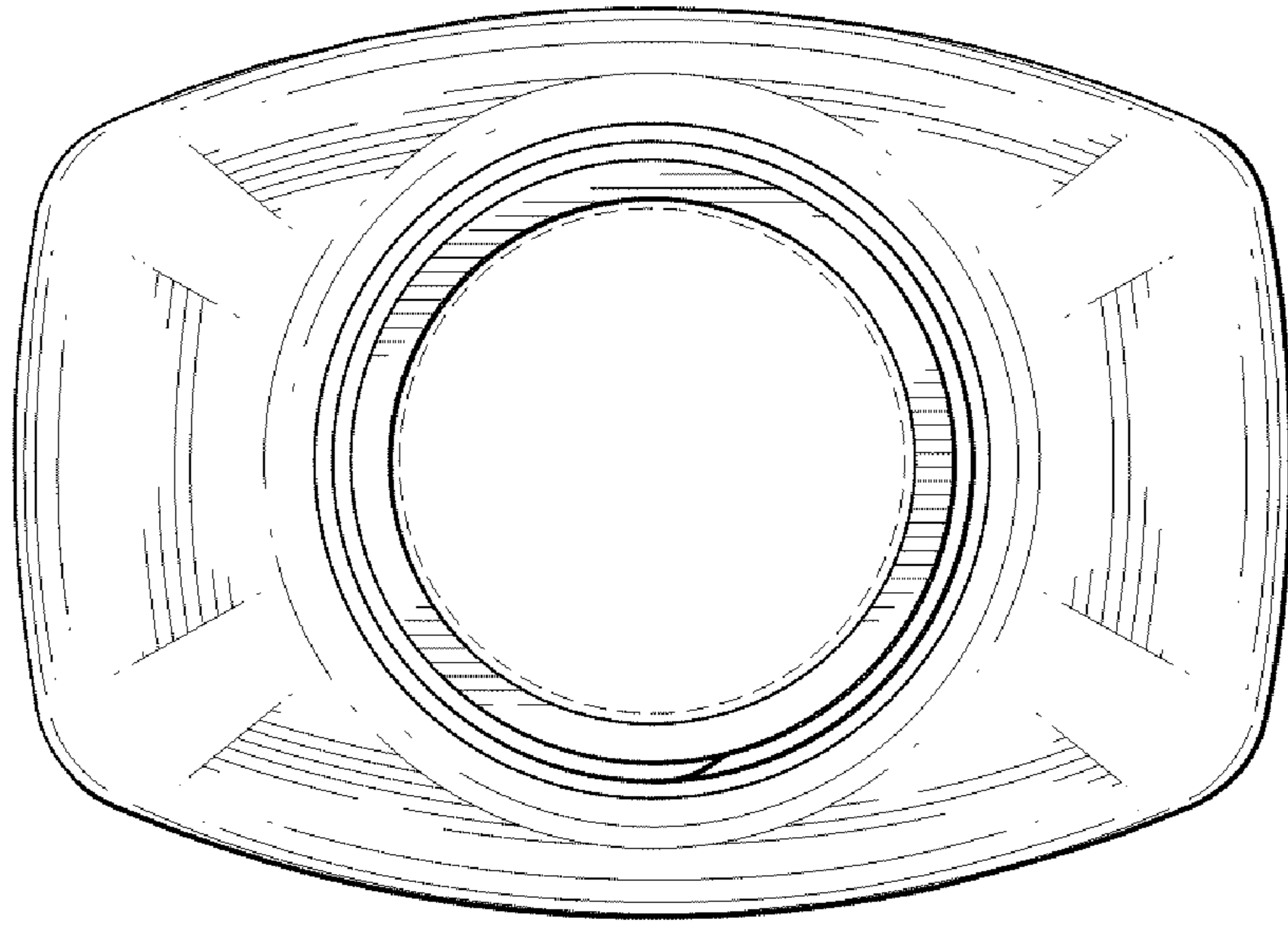

FIG. 5

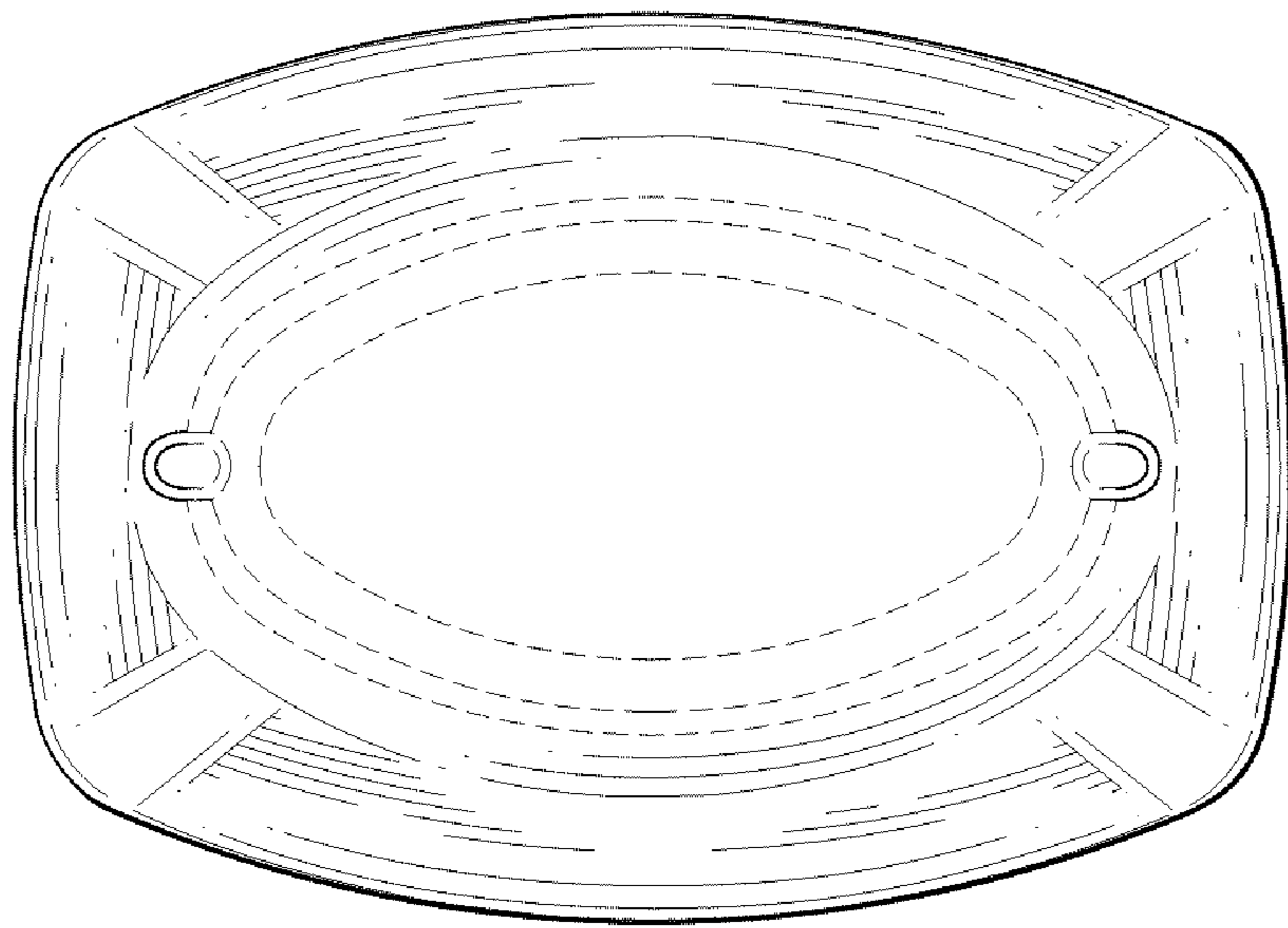

FIG. 6

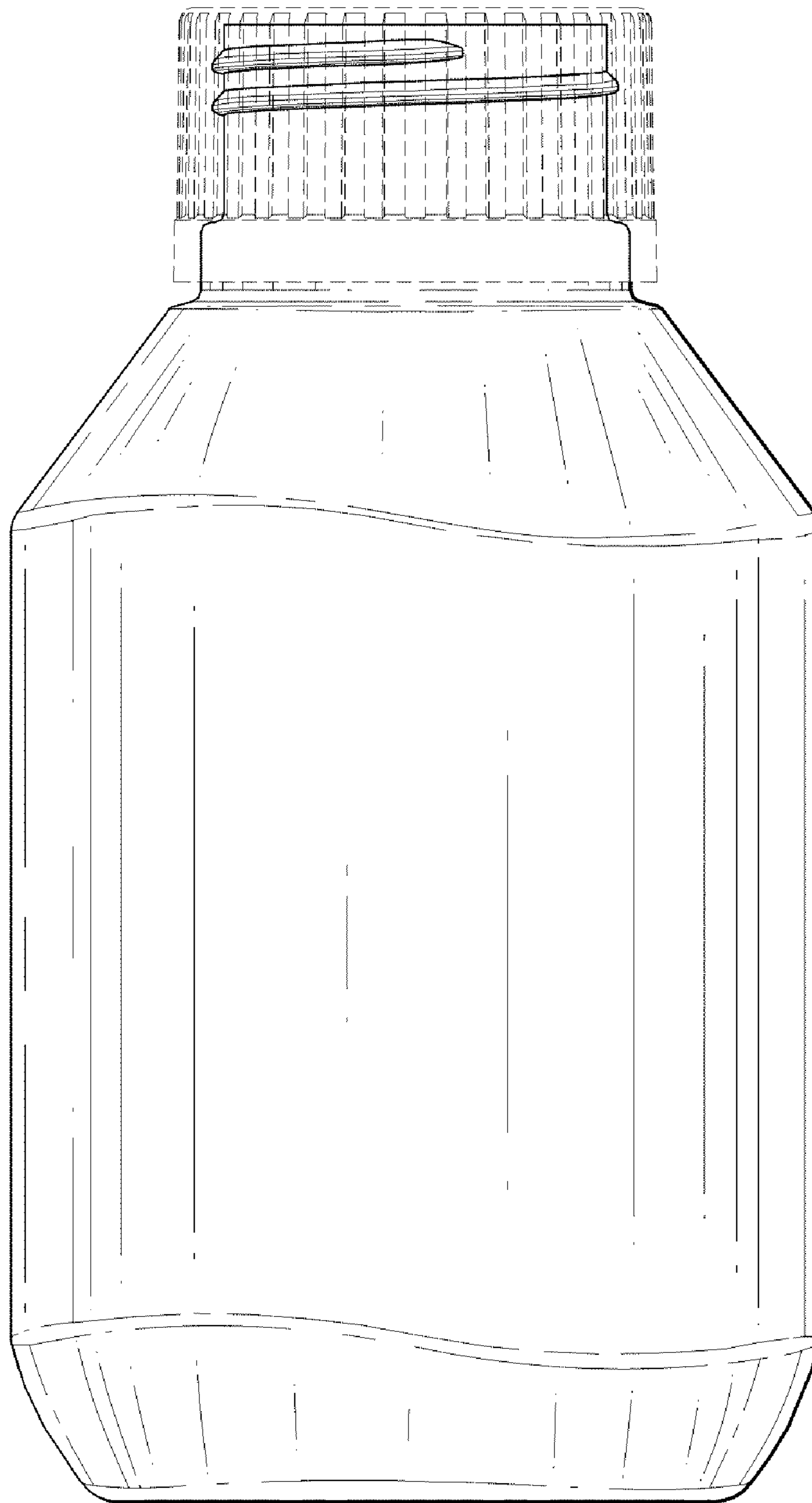

FIG. 7

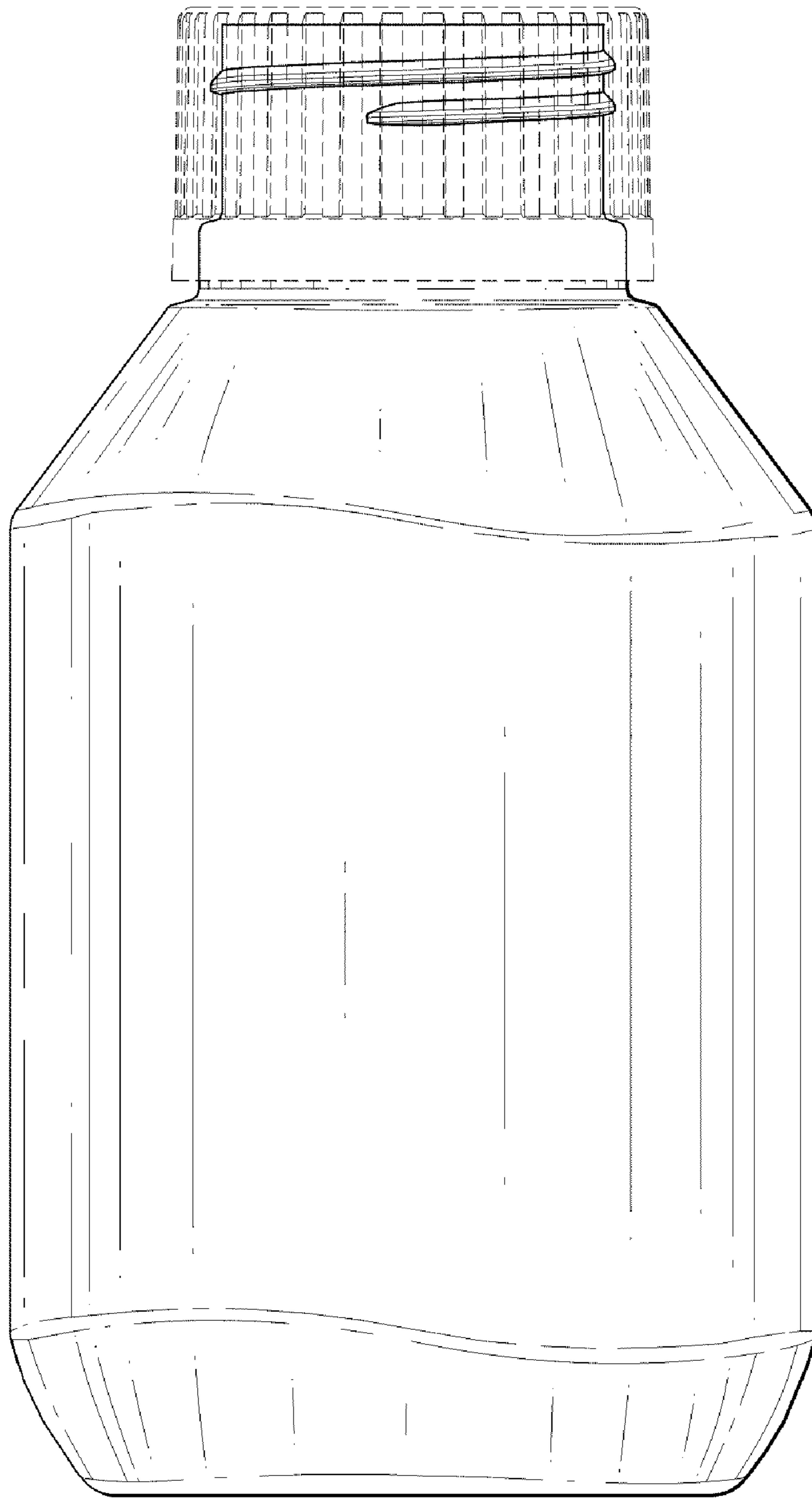

FIG. 8

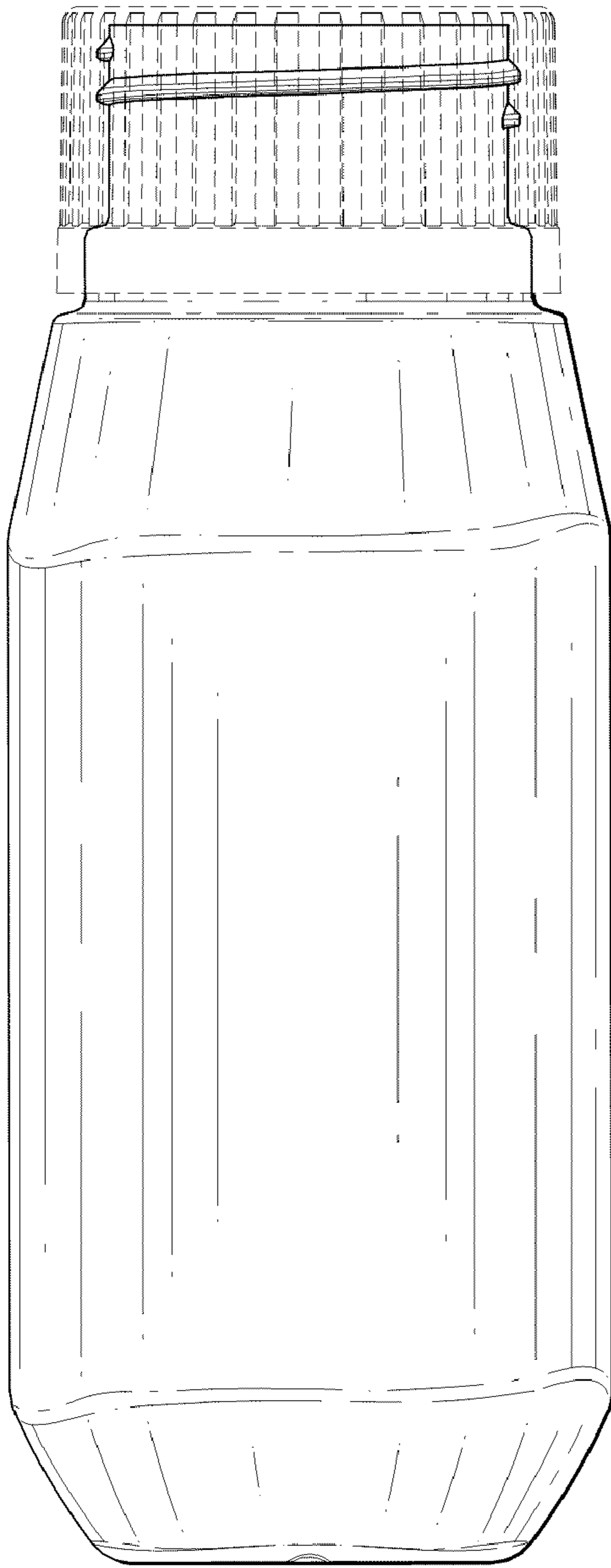

FIG. 9

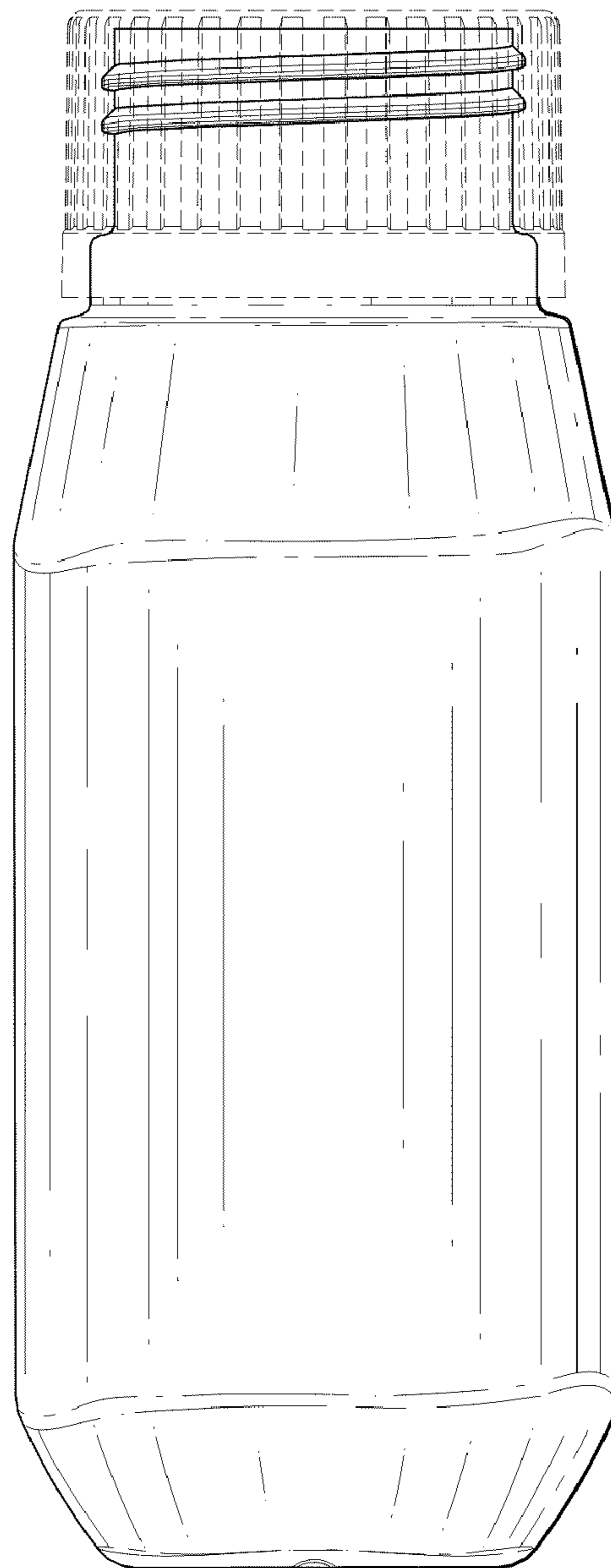

FIG. 10

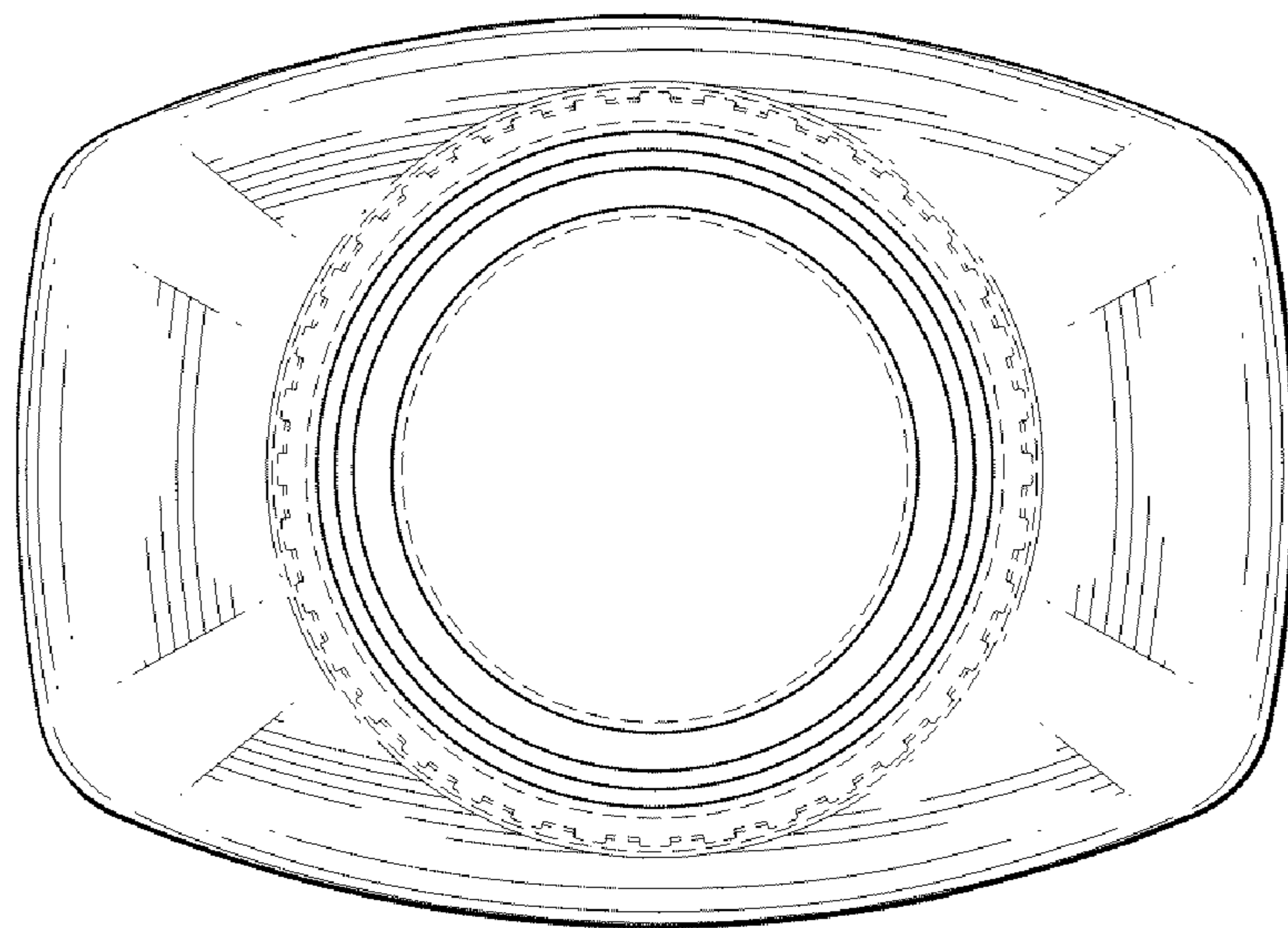

FIG. 11

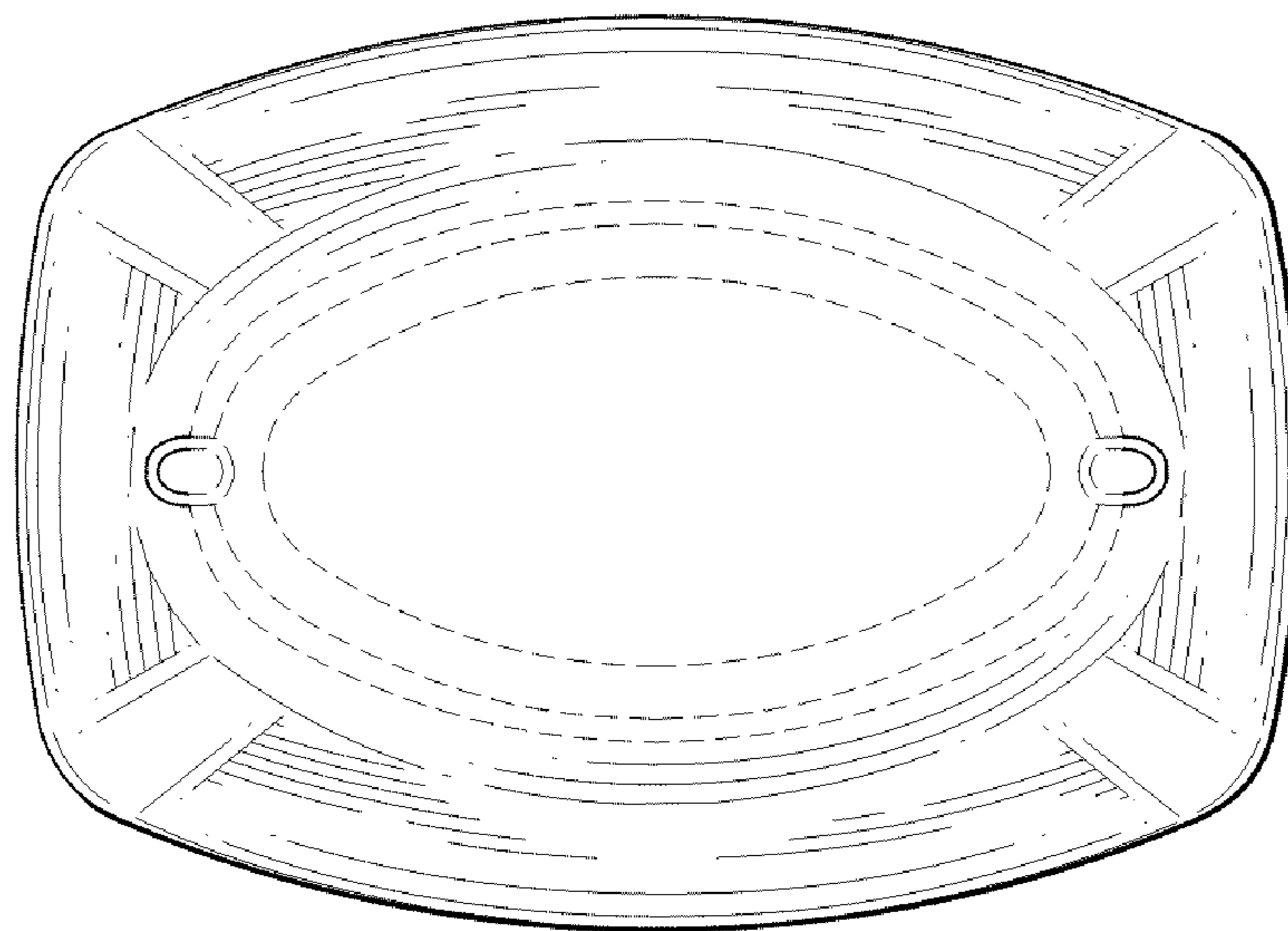

FIG. 12

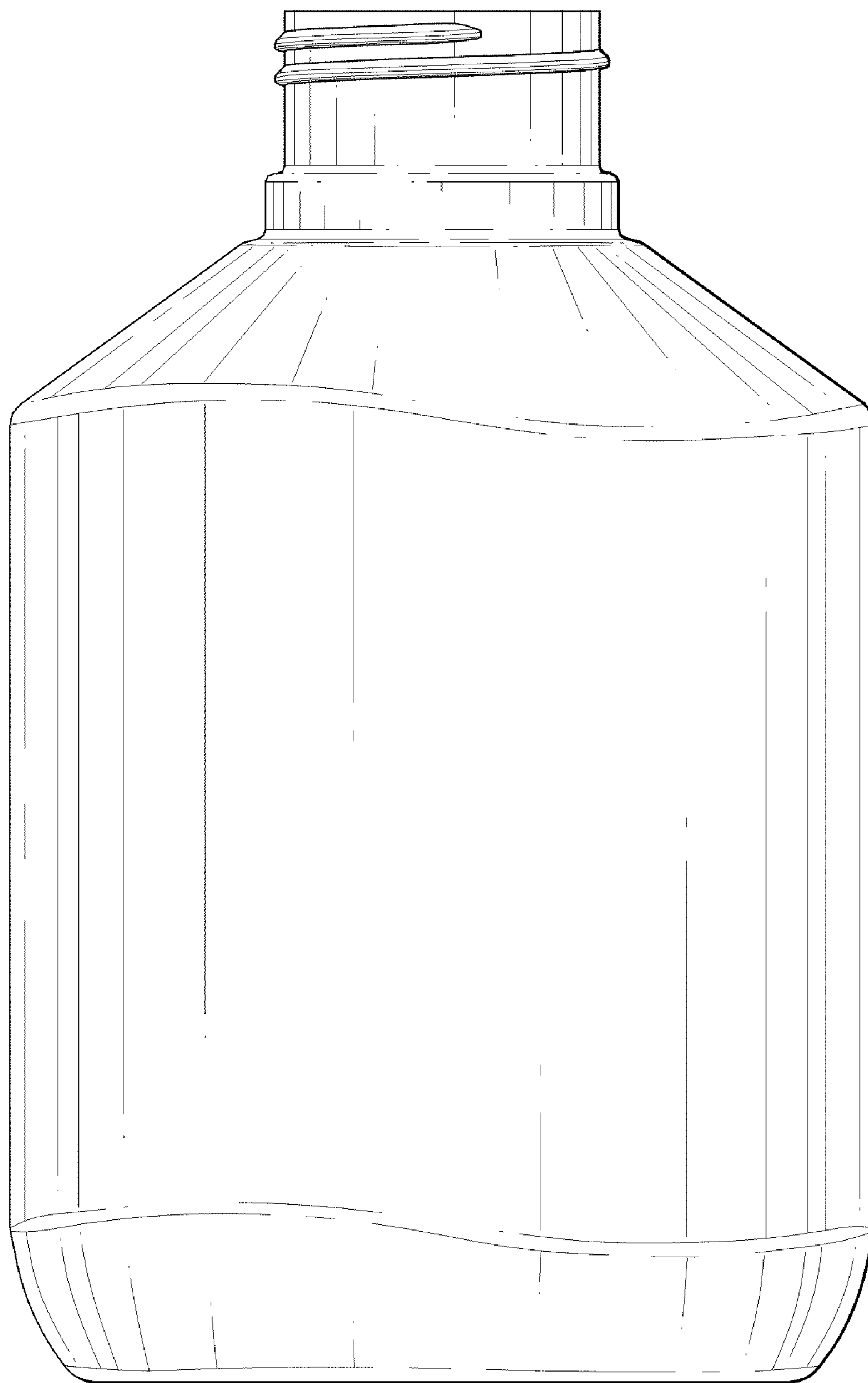

FIG. 13

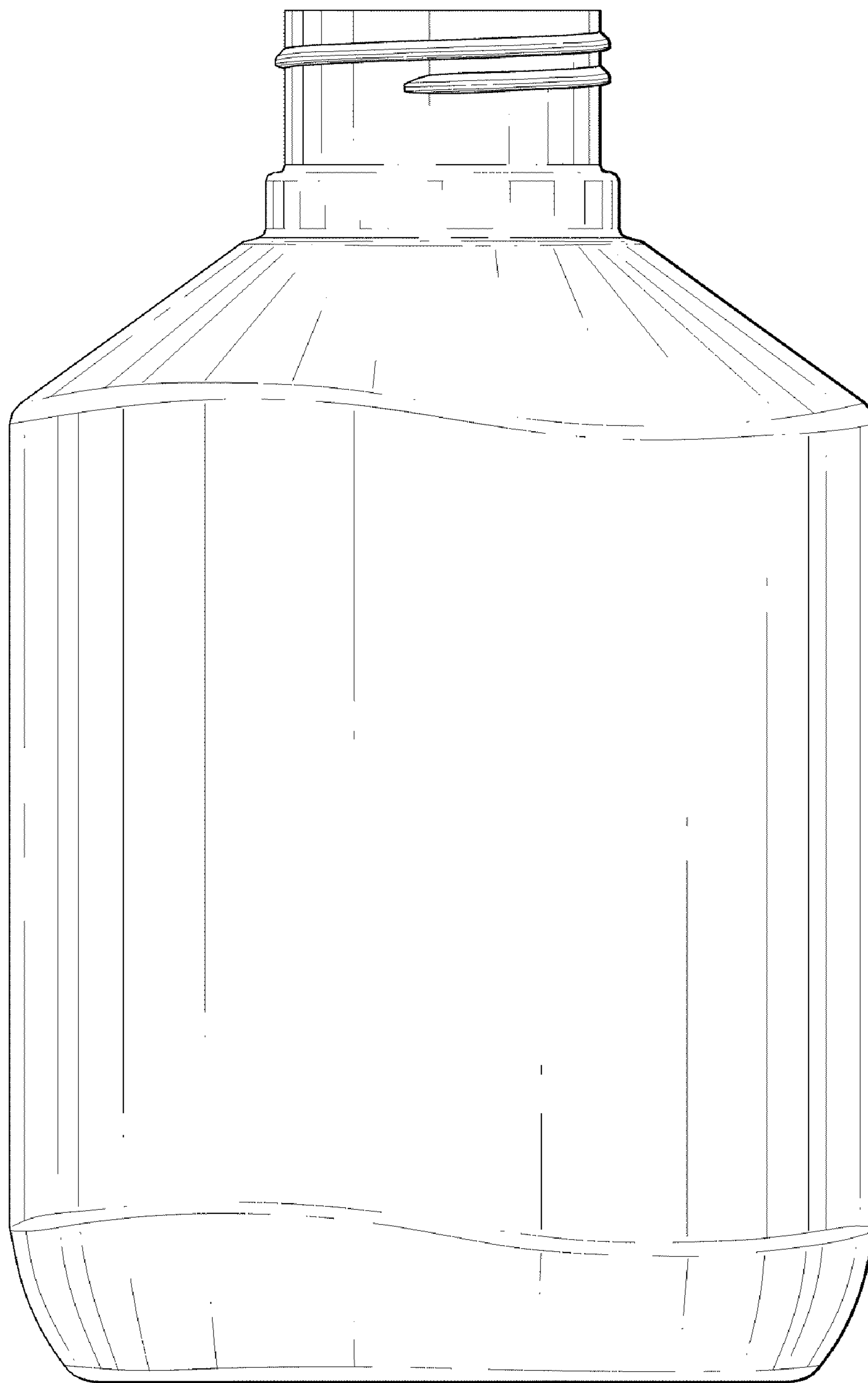

FIG. 14

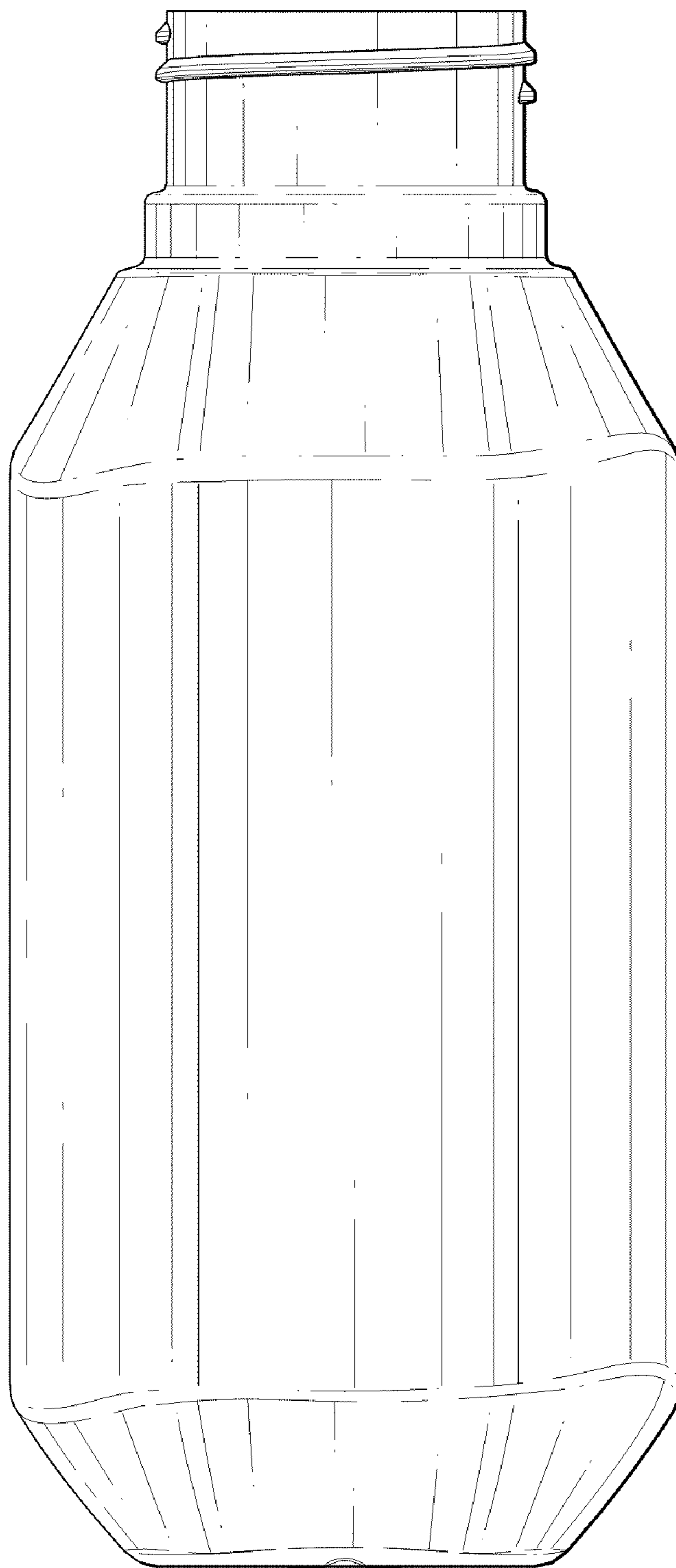

FIG. 15

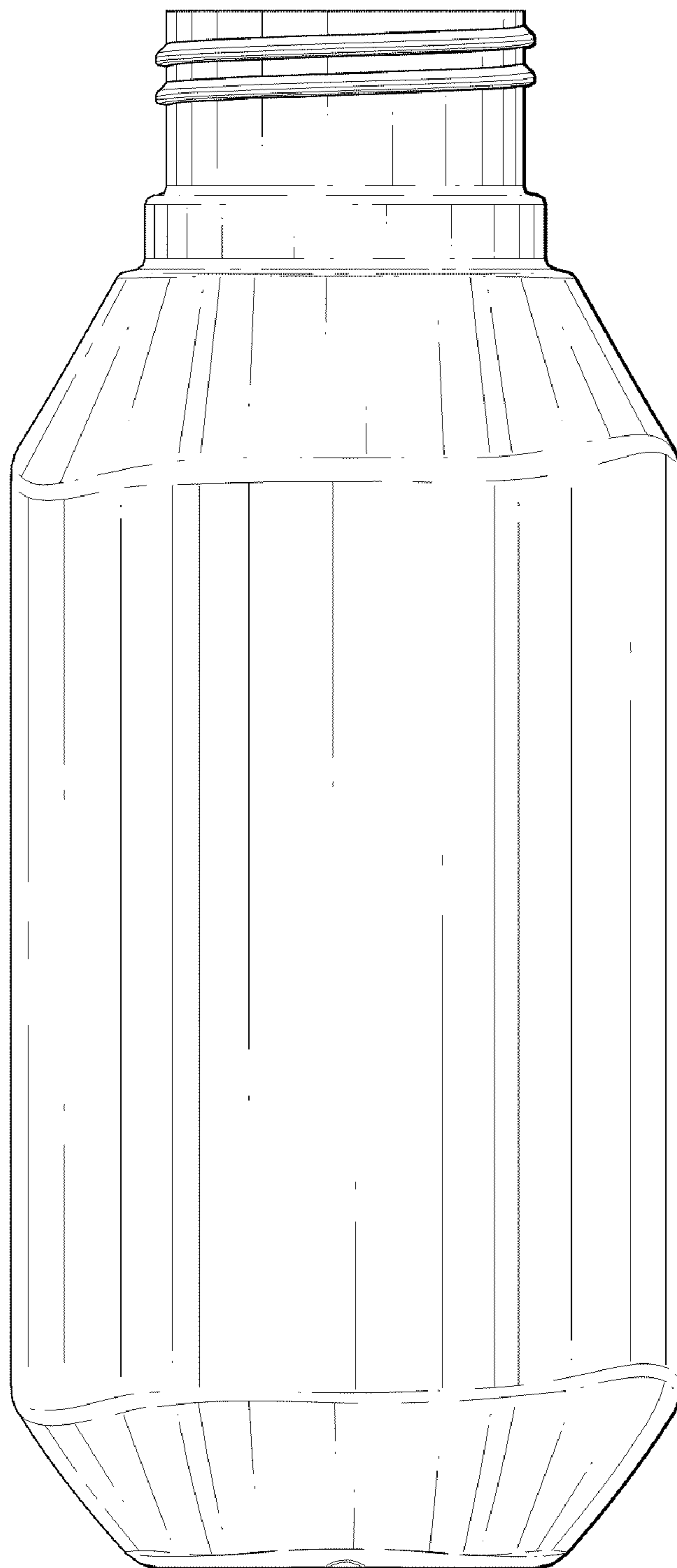

FIG. 16

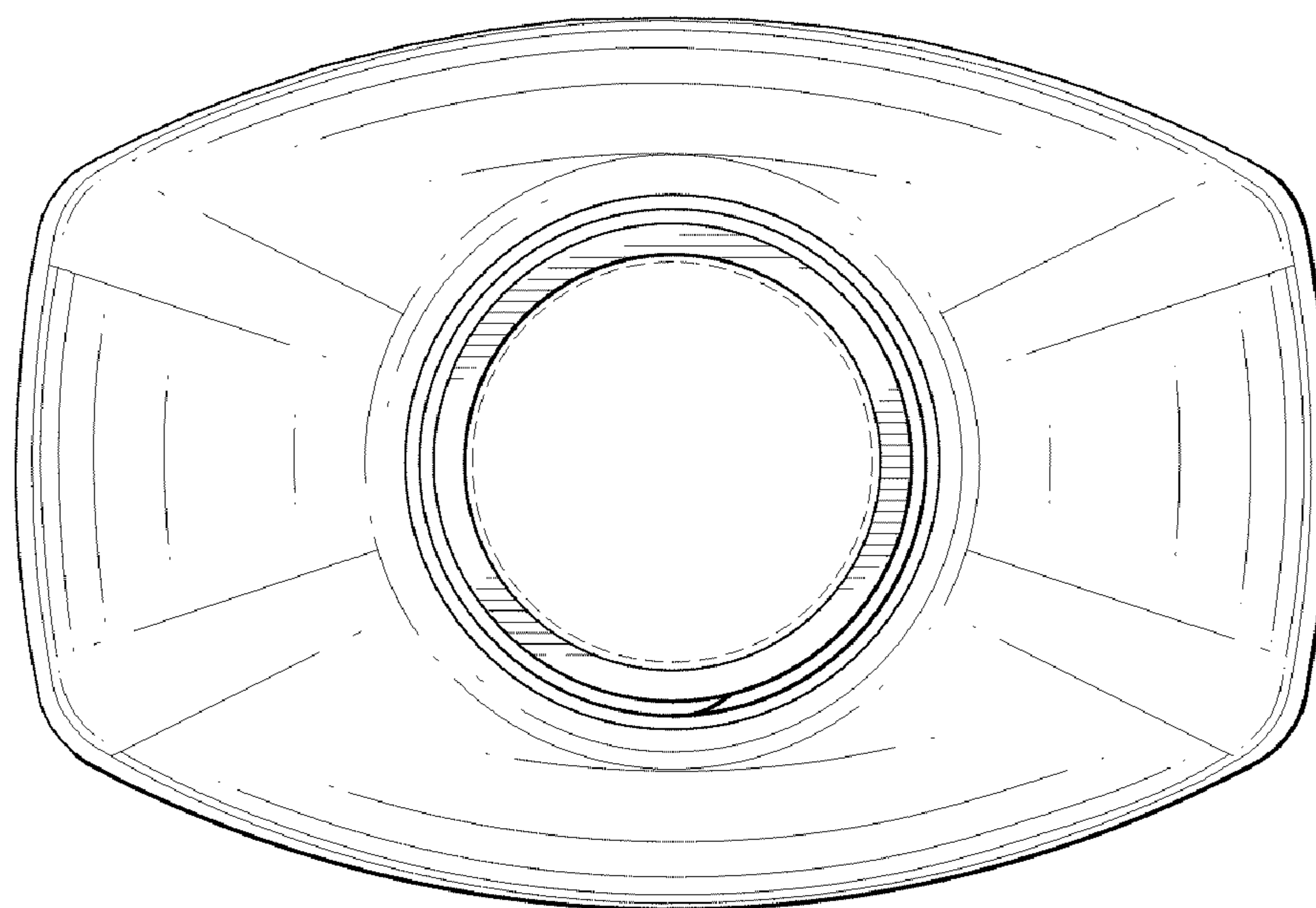

FIG. 17

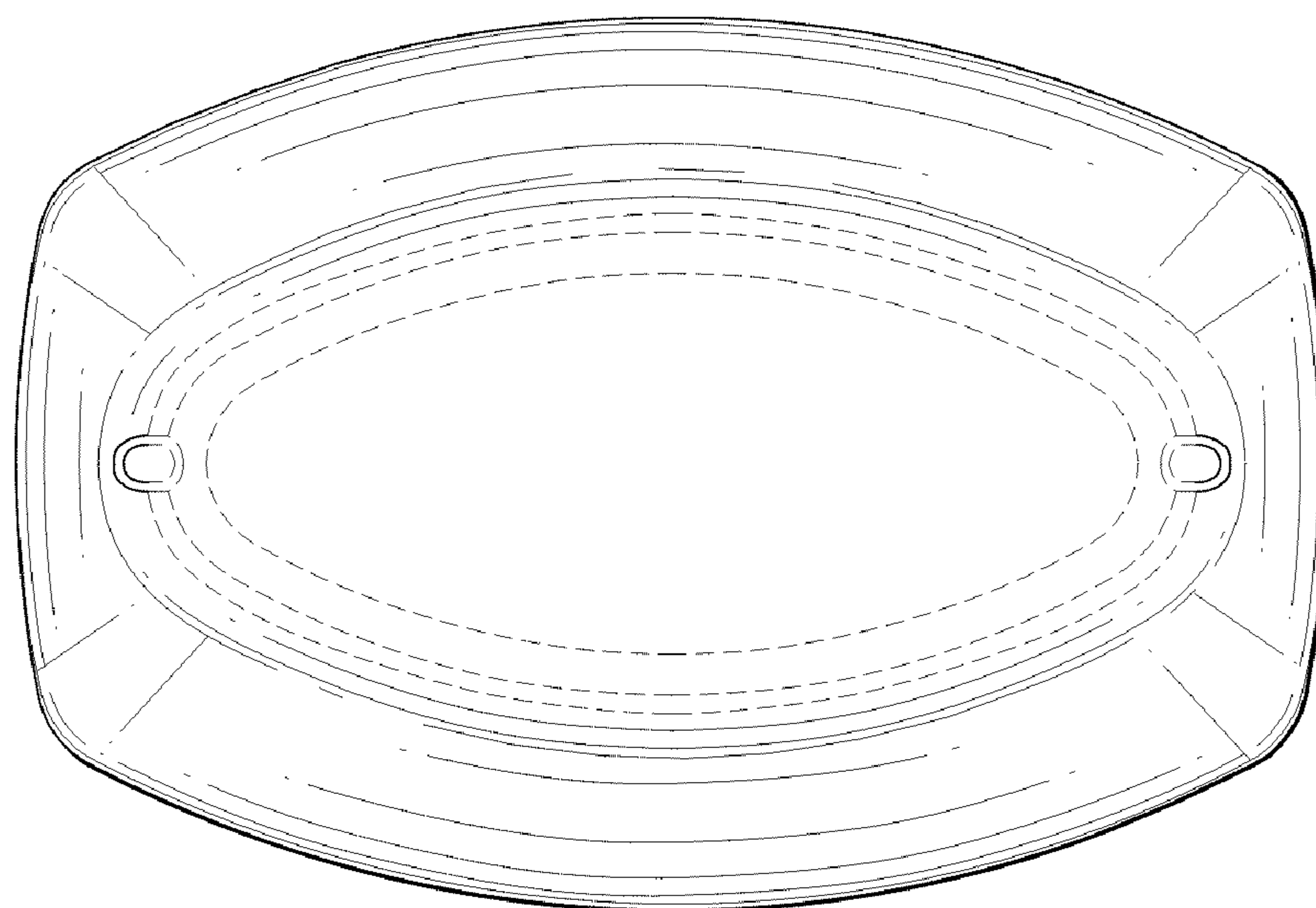

FIG. 18

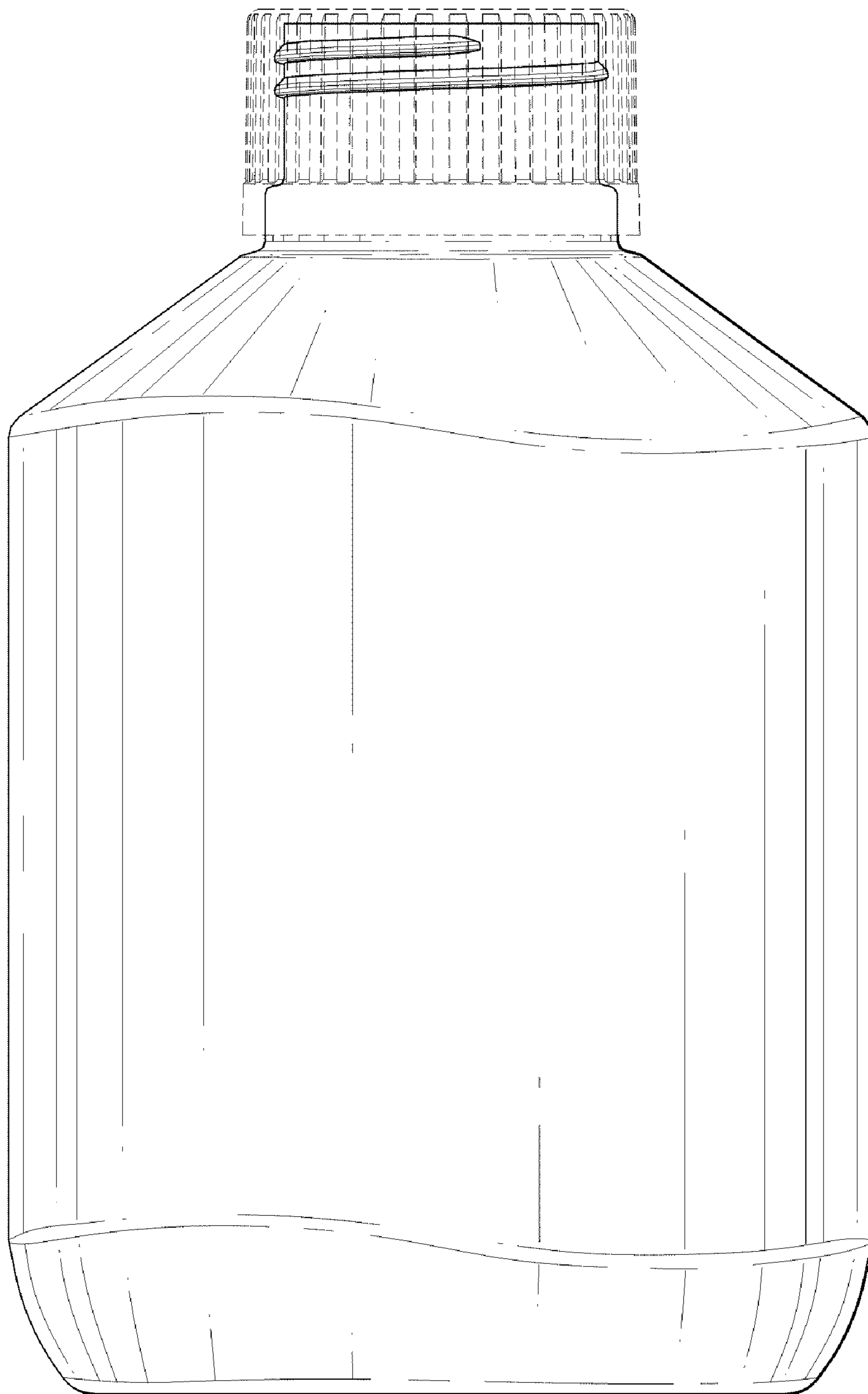

FIG. 19

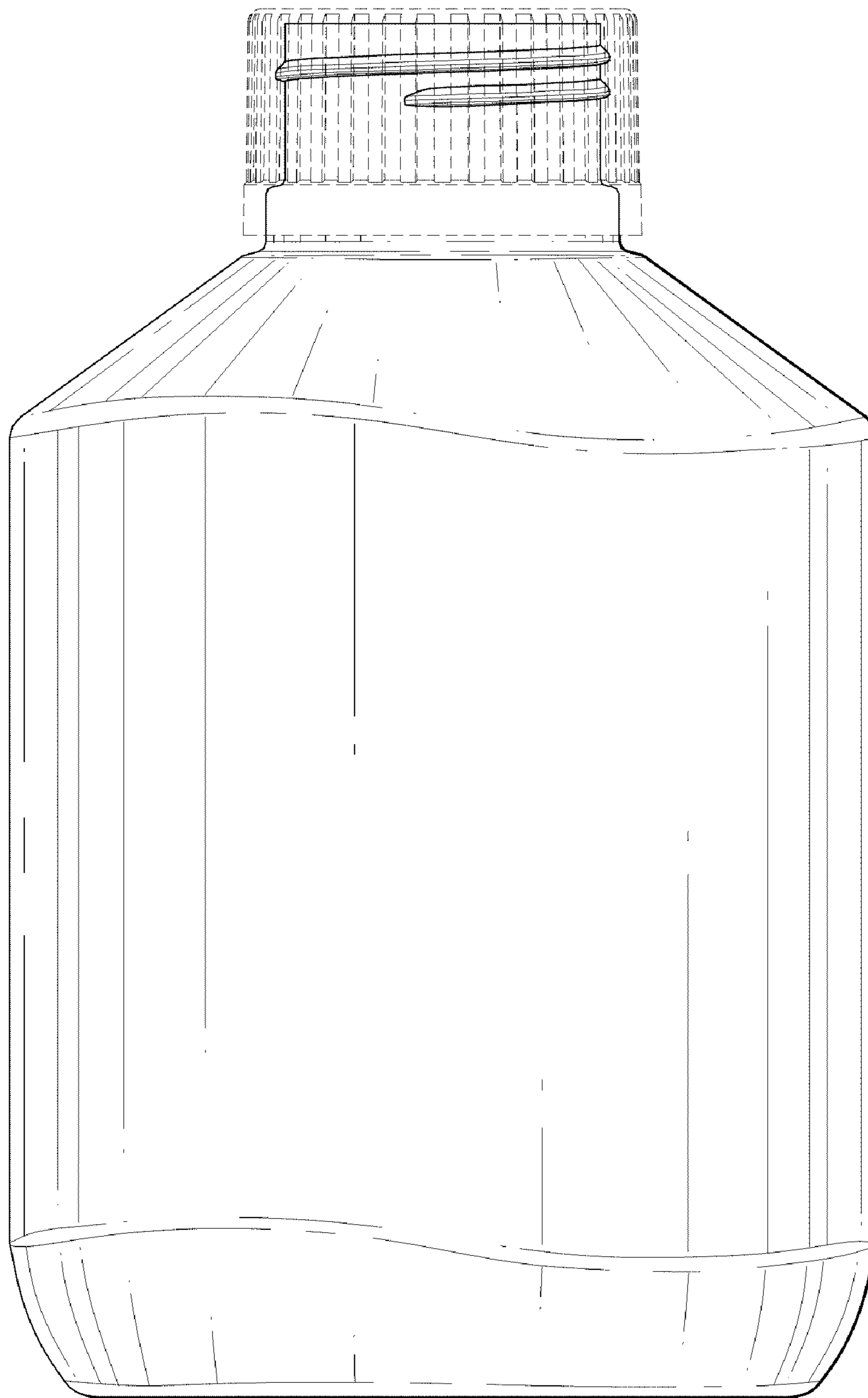

FIG. 20

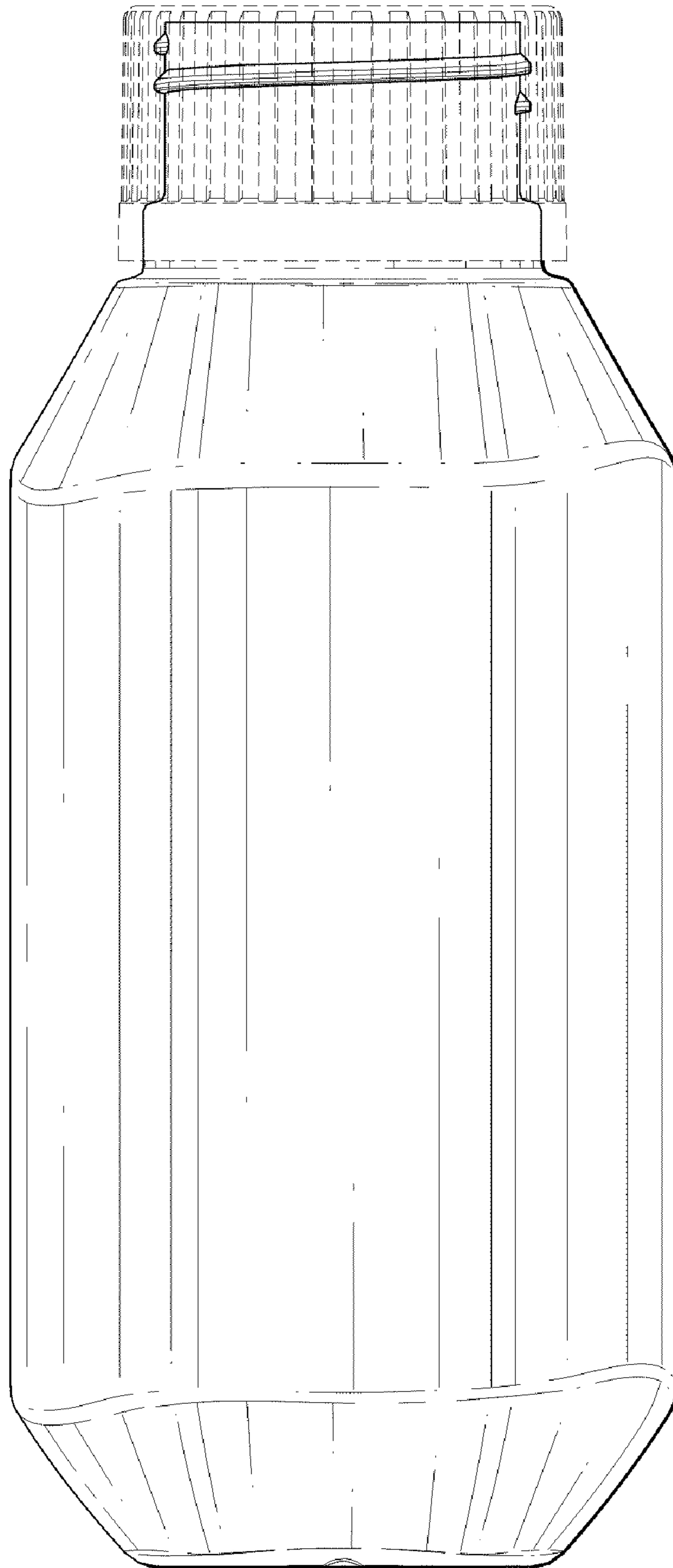

FIG. 21

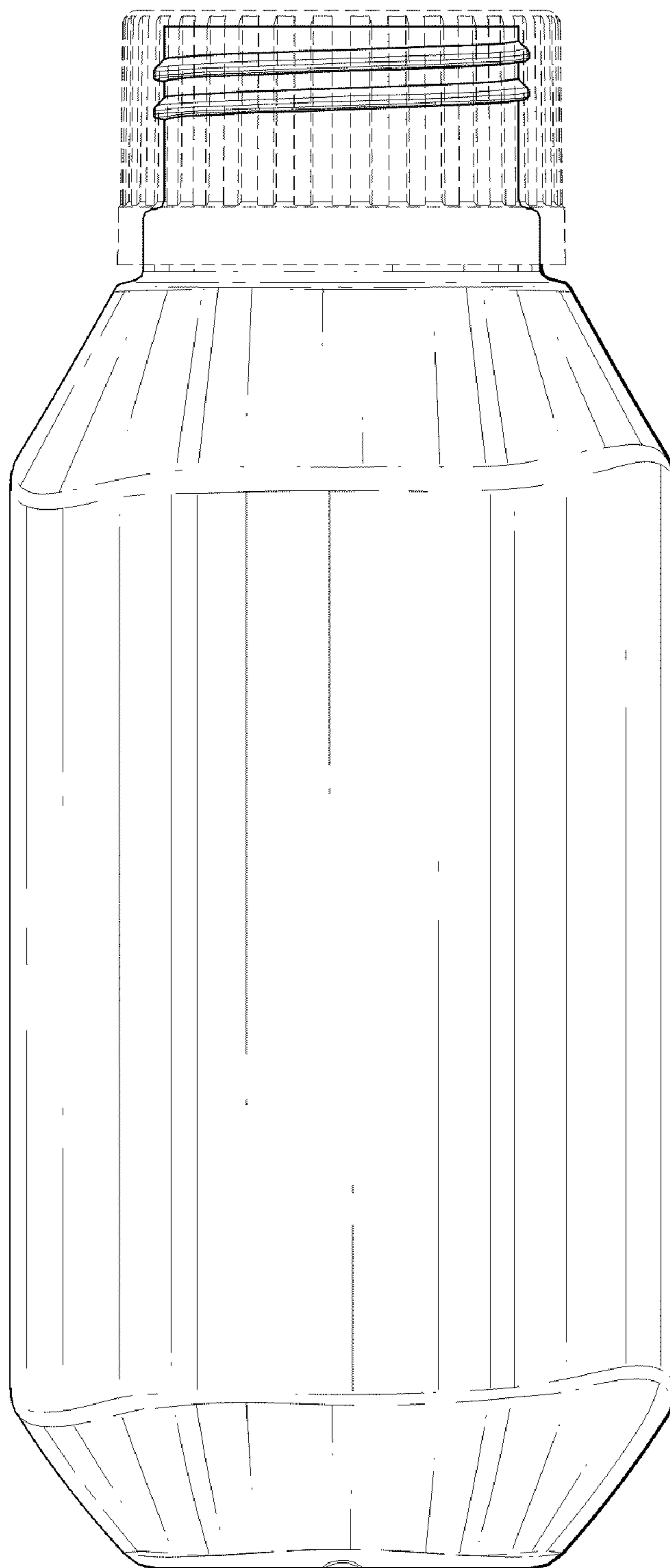

FIG. 22

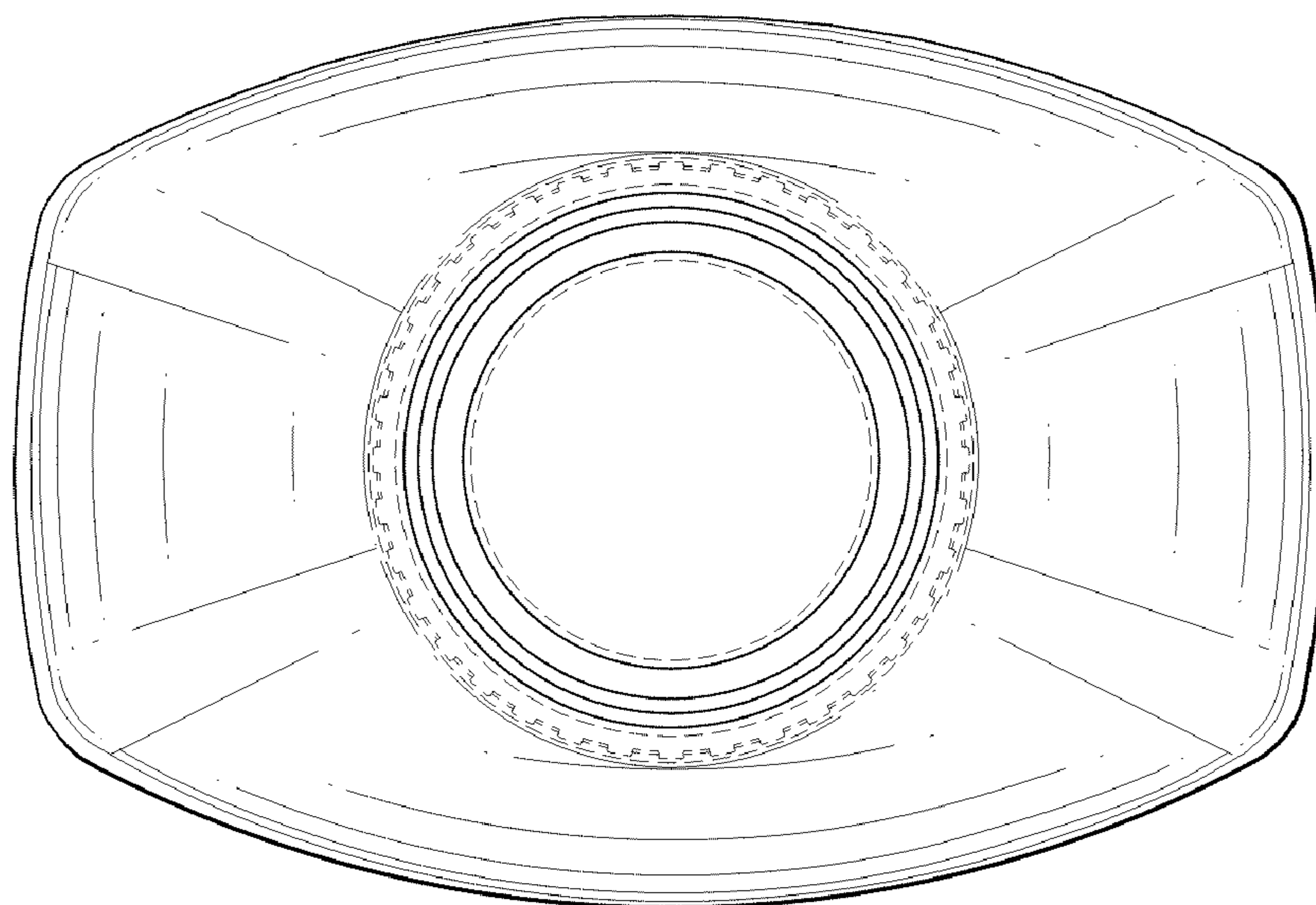

FIG. 23

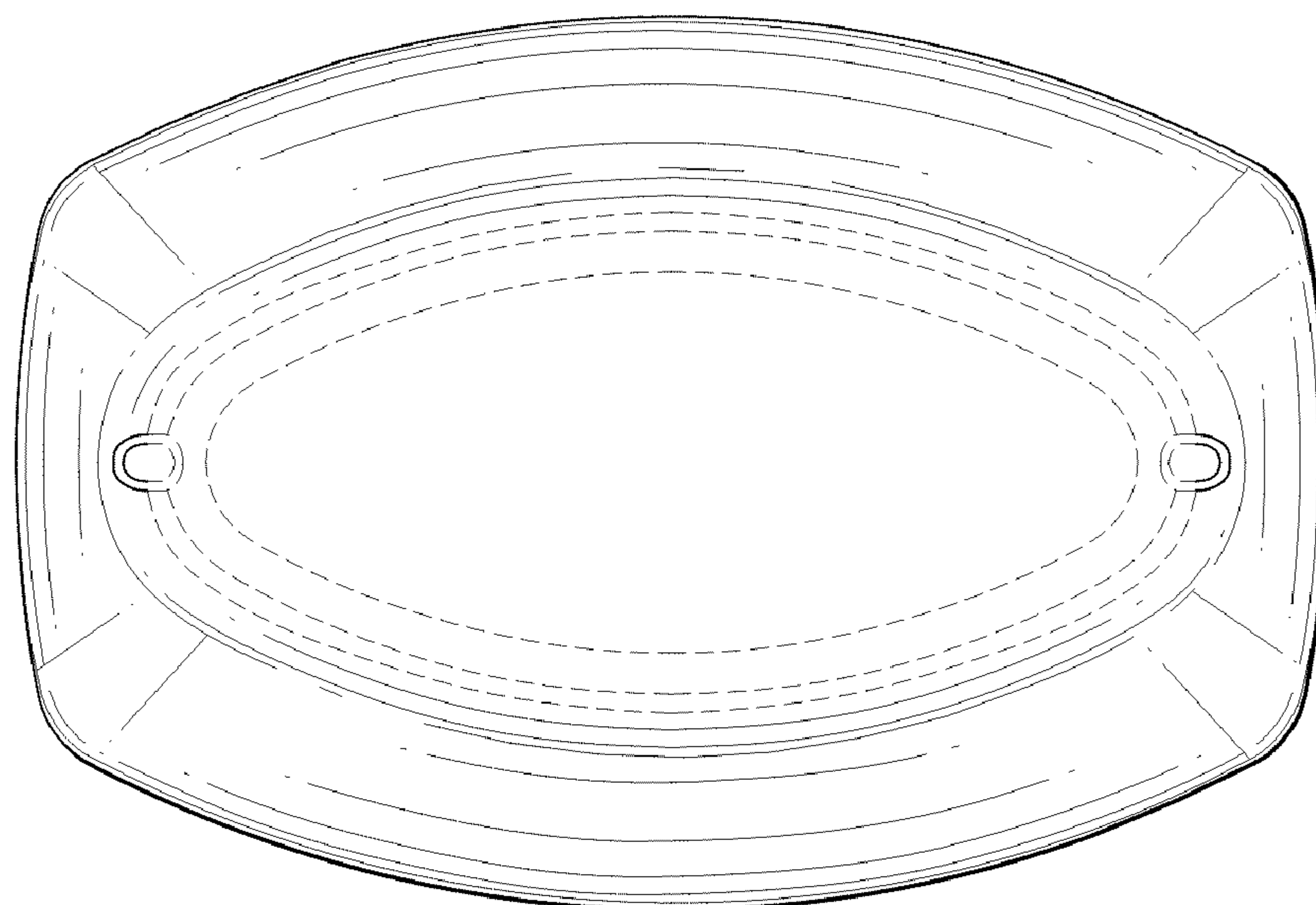

FIG. 24