



US00D643736S

(12) **United States Design Patent**
Lagerqvist

(10) **Patent No.:** **US D643,736 S**

(45) **Date of Patent:** **** Aug. 23, 2011**

(54) **BOTTLE**

(75) Inventor: **John Lagerqvist**, Stockholm (SE)

(73) Assignee: **V & S Vin Sprit Aktiebolag**, Stockholm (SE)

(**) Term: **14 Years**

(21) Appl. No.: **29/376,947**

(22) Filed: **Oct. 14, 2010**

(51) **LOC (9) Cl.** **09-01**

(52) **U.S. Cl.** **D9/550; D9/553; D9/558; D9/574**

(58) **Field of Classification Search** D9/500,
D9/505, 516, 544-546, 549-550, 553-555,
D9/558, 566-568, 572-575; 215/379, 381-383;
220/660, 662, 669-673, 675

See application file for complete search history.

(56) **References Cited**

U.S. PATENT DOCUMENTS

D64,816 S *	6/1924	Sears	D9/550
D67,215 S *	5/1925	Lents	D9/555
D94,574 S *	2/1935	Steelman	D9/545
D94,575 S *	2/1935	Steelman	D9/550
D100,495 S *	7/1936	Goggin	D9/555
D103,164 S *	2/1937	Smith	D9/550
D178,529 S *	8/1956	Lorenzen	D9/555
D201,840 S *	8/1965	Hauser	D9/555
D353,324 S *	12/1994	Rice, III	D9/661

D369,556 S *	5/1996	Lauder et al.	D9/553
D395,826 S *	7/1998	Hygaard, Sr.	D9/520
D411,740 S *	6/1999	Kim	D9/658
D448,677 S *	10/2001	Krich	D9/553
D452,442 S *	12/2001	Bowen	D9/503
D538,169 S *	3/2007	Nosselbock	D9/550
D544,363 S *	6/2007	Hendricks et al.	D9/555
D582,781 S *	12/2008	Miller	D9/538
D587,595 S *	3/2009	Schuemann	D9/631

* cited by examiner

Primary Examiner — Ian Simmons

Assistant Examiner — Dana L Sipos

(74) *Attorney, Agent, or Firm* — McDermott Will & Emery LLP

(57) **CLAIM**

The ornamental design for a bottle, as shown and described.

DESCRIPTION

FIG. 1 is a front perspective view of the bottle, showing the new design;

FIG. 2 is a front view of the bottle;

FIG. 3 is a rear view of the bottle;

FIG. 4 is a side view of the bottle;

FIG. 5 is another side view of the bottle;

FIG. 6 is a top view of the bottle; and,

FIG. 7 is a bottom view of the bottle.

1 Claim, 6 Drawing Sheets

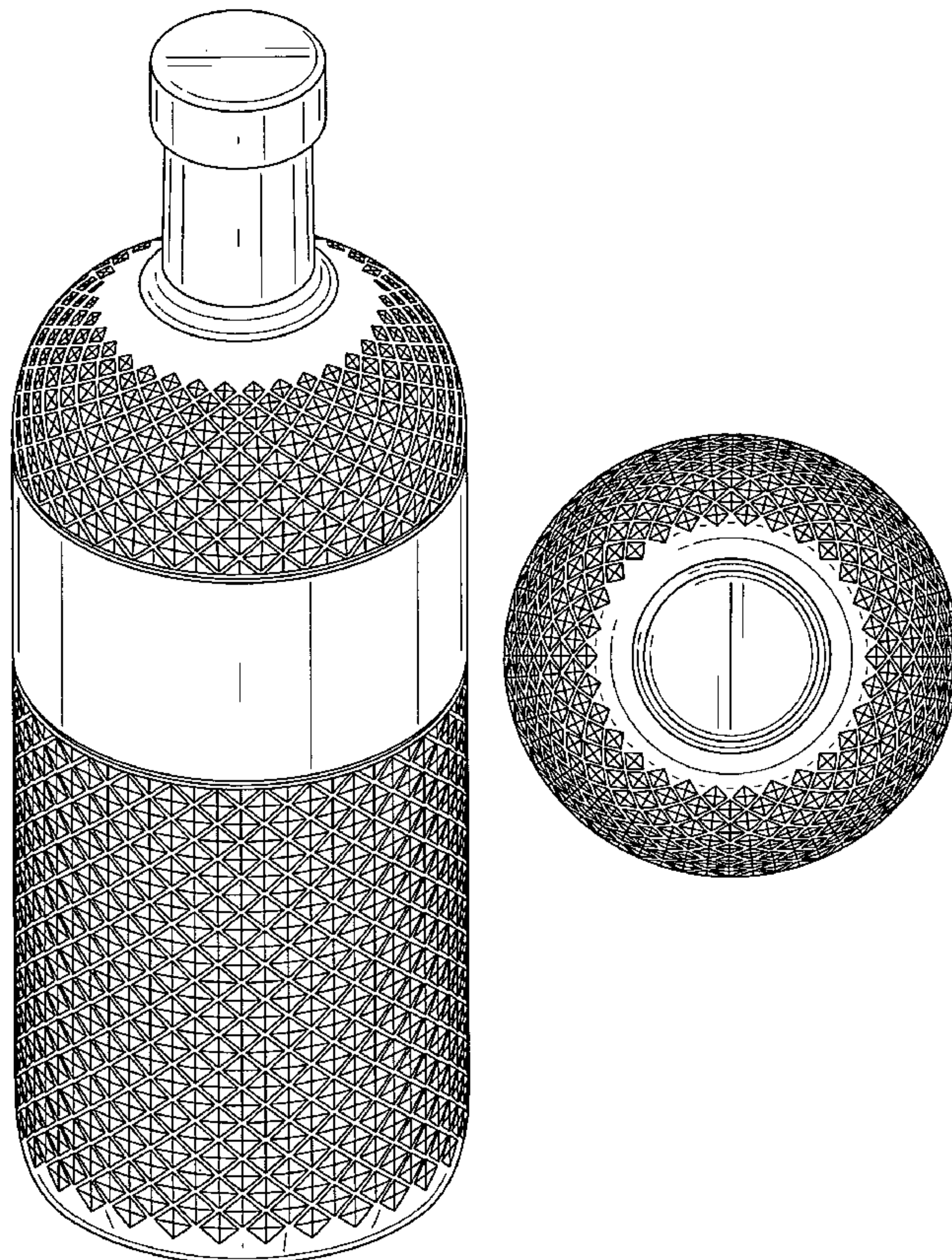

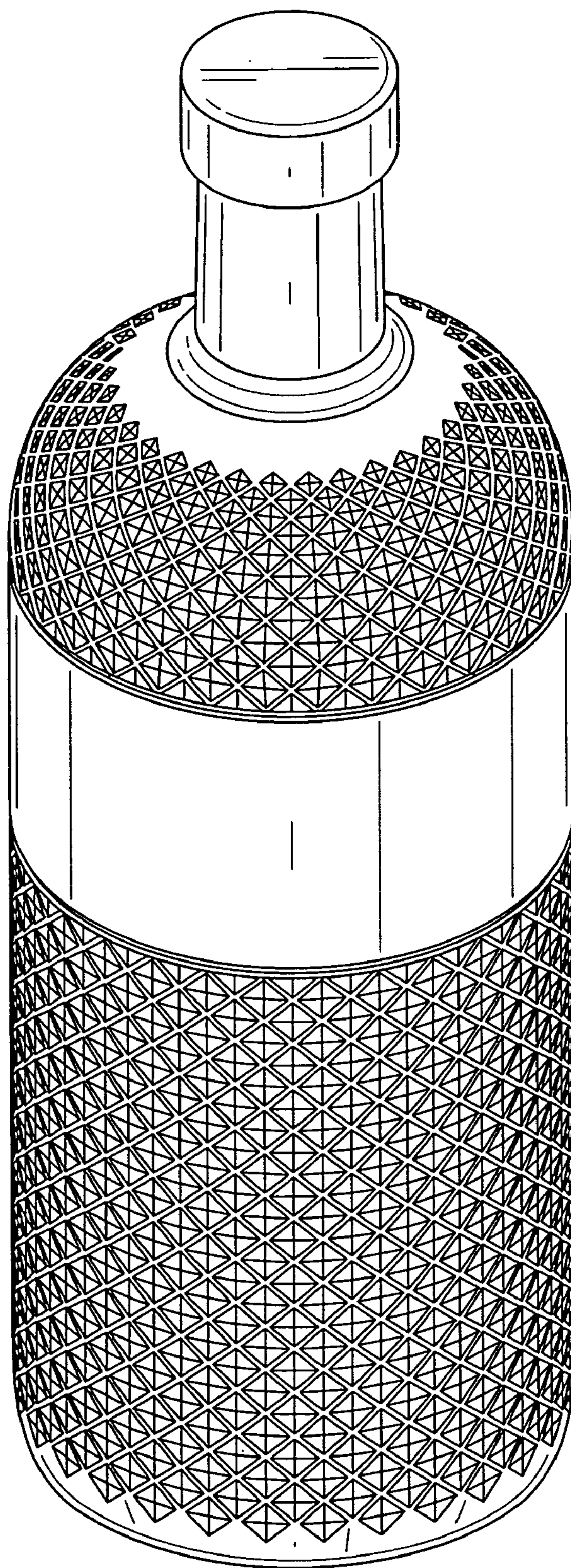

FIG. 1

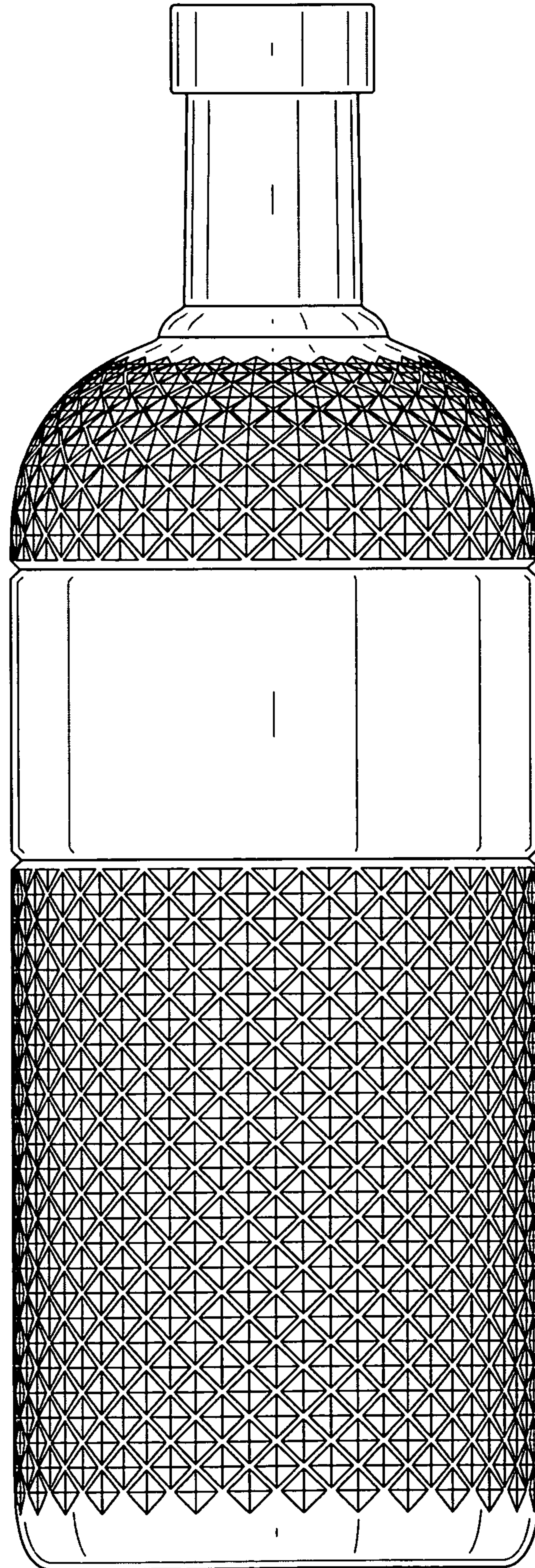

FIG. 2

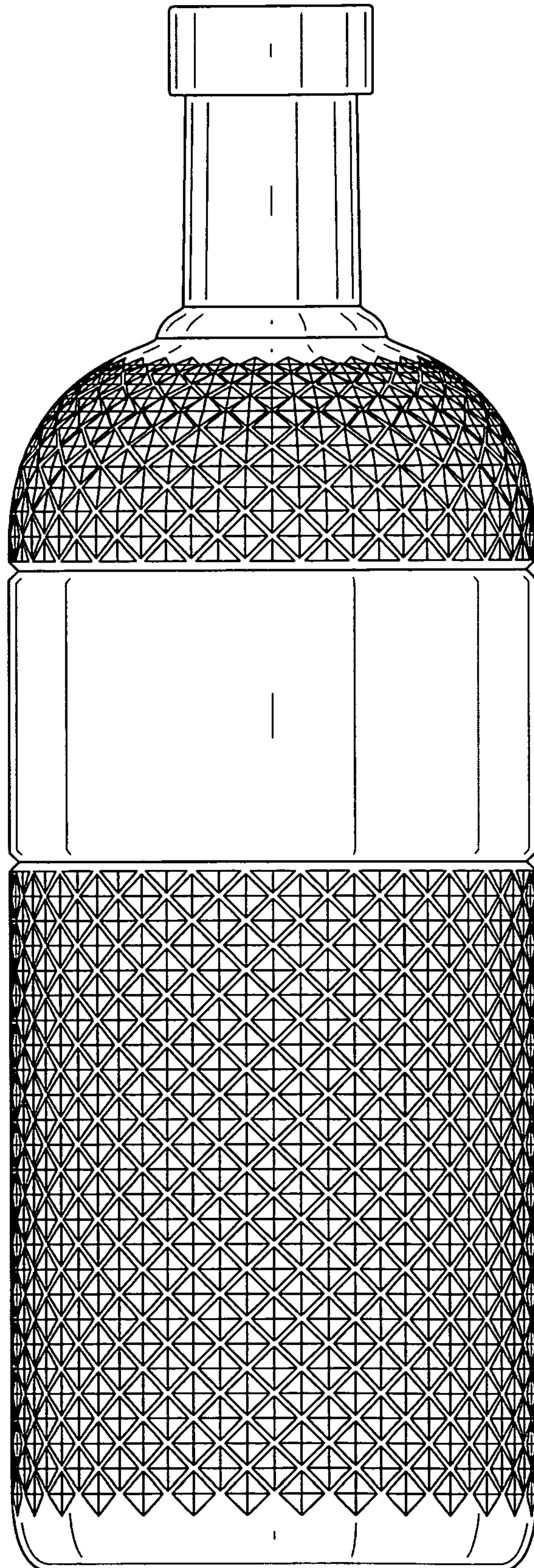

FIG. 3

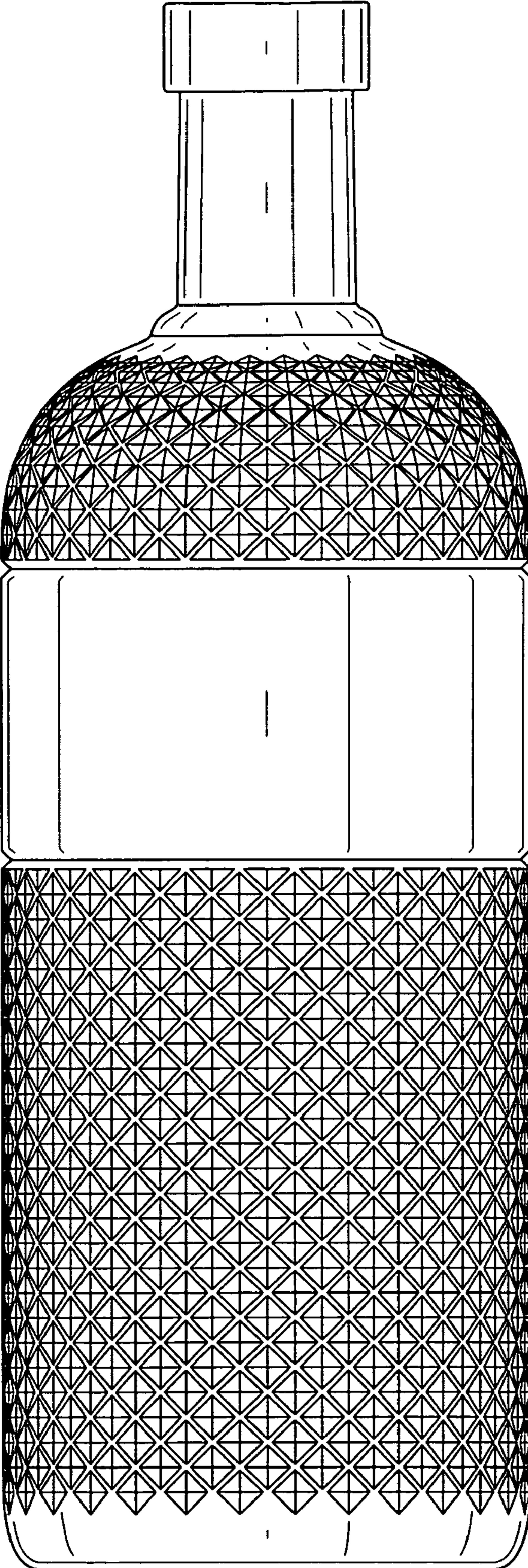

FIG. 4

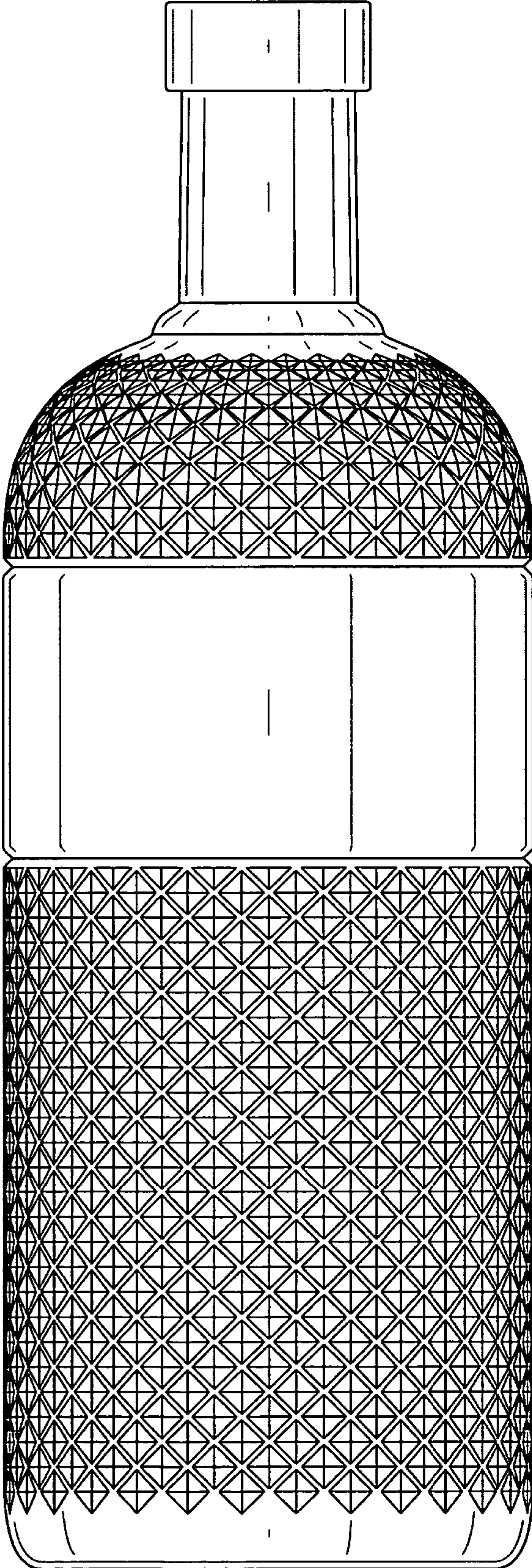

FIG. 5

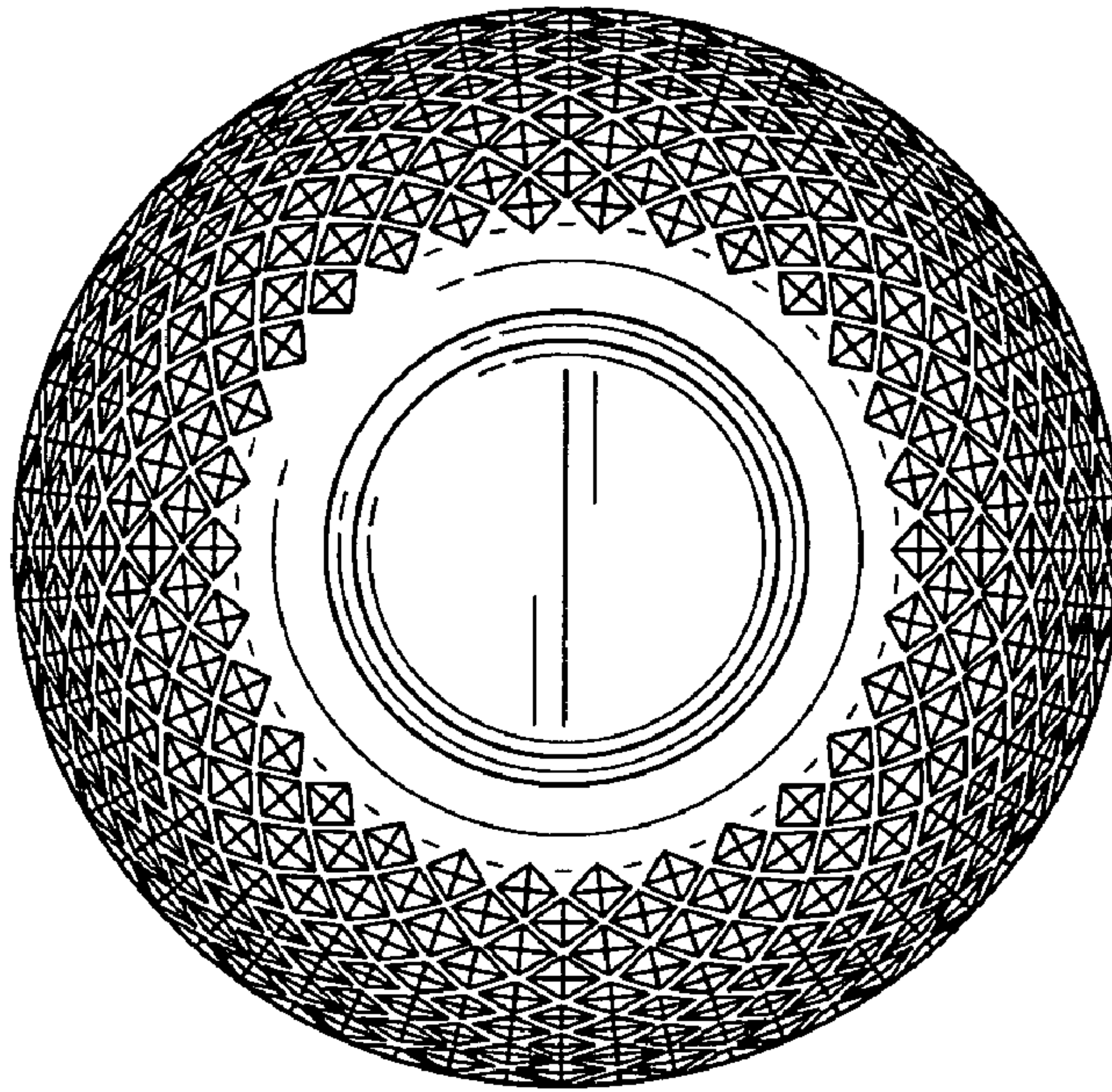

FIG. 6

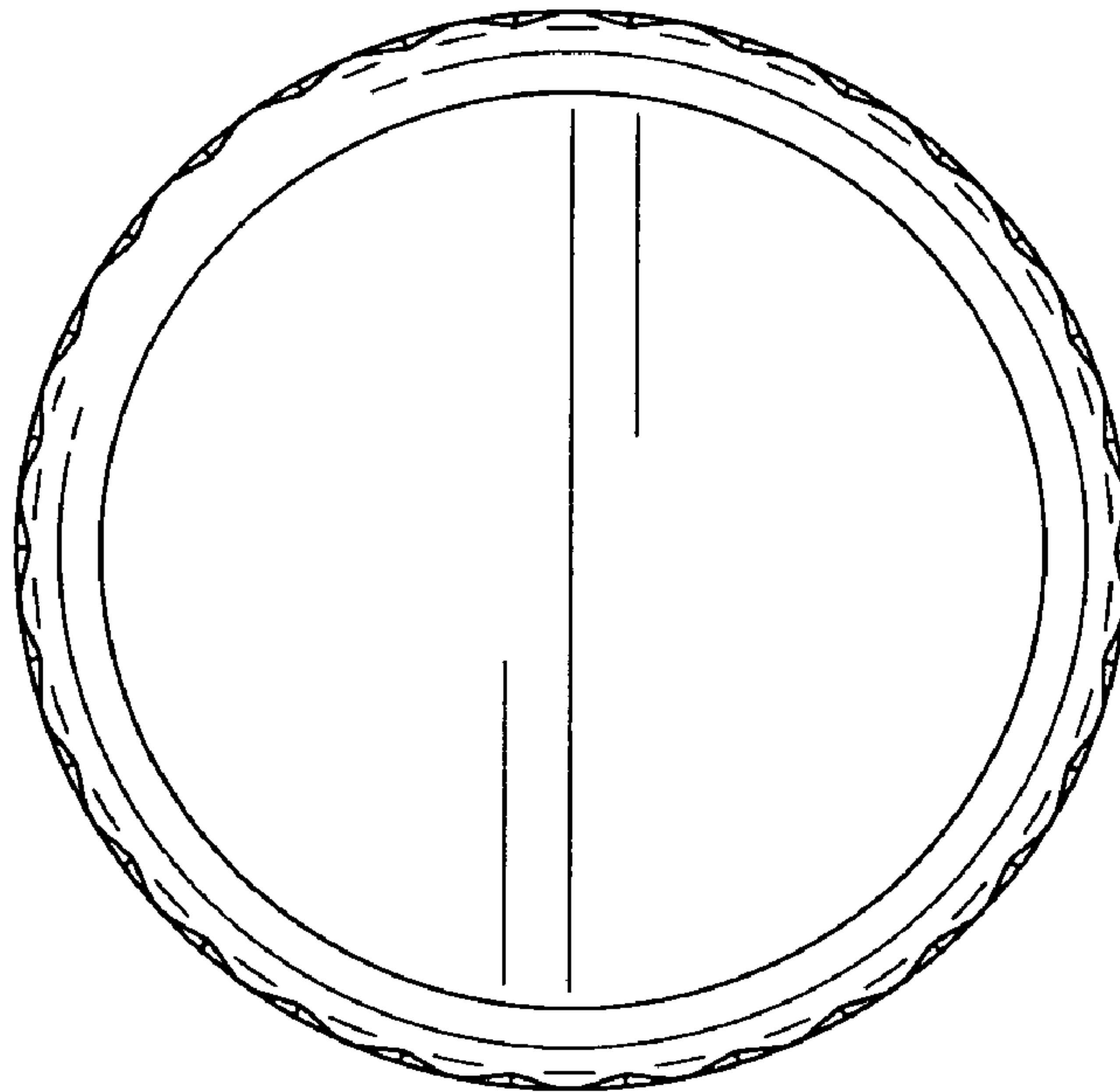

FIG. 7