



US00D643708S

(12) **United States Design Patent**  
**Hecht**

(10) **Patent No.:** **US D643,708 S**

(45) **Date of Patent:** **\*\* Aug. 23, 2011**

(54) **CLIP**

(75) Inventor: **Thomas R. Hecht**, Winters, CA (US)

(73) Assignee: **Automatic Bar Controls, Inc.**,  
Vacaville, CA (US)

(\*\*) Term: **14 Years**

(21) Appl. No.: **29/380,329**

(22) Filed: **Dec. 2, 2010**

(51) **LOC (9) Cl.** ..... **08-08**

(52) **U.S. Cl.** ..... **D8/394; D8/396**

(58) **Field of Classification Search** ..... D8/354,  
D8/356, 371, 394–396; D19/65, 86; D24/128;  
248/74.2, 215, 227.1, 49, 300, 301, 316.7,  
248/51, 489; 24/570, 3.12; D3/203.2, 203.3;  
D21/392

See application file for complete search history.

(56) **References Cited**

U.S. PATENT DOCUMENTS

D227,742	S	*	7/1973	Logsdon	.....	D8/354
4,084,778	A	*	4/1978	Dominguez	.....	248/314
4,278,225	A	*	7/1981	Phelps	.....	248/311.3
D408,273	S	*	4/1999	Senninger	.....	D8/356
D410,968	S	*	6/1999	Swan et al.	.....	D20/22
D417,611	S	*	12/1999	van de Lande	.....	D8/395
D423,774	S	*	5/2000	Peterson	.....	D3/229
6,164,286	A	*	12/2000	Schad	.....	131/248
D444,706	S	*	7/2001	Giancaspro	.....	D9/455
D498,357	S	*	11/2004	Smith	.....	D3/215
D516,402	S	*	3/2006	Gates et al.	.....	D8/71
D543,447	S	*	5/2007	Allsopp	.....	D8/394

H2203	H	*	10/2007	Borchardt et al.	.....	D8/396
D562,675	S	*	2/2008	Cox et al.	.....	D8/395
D601,883	S	*	10/2009	Catoggio	.....	D8/396
D604,154	S	*	11/2009	Allsopp	.....	D8/395
D626,404	S	*	11/2010	Koehn	.....	D8/373
2005/0102885	A1	*	5/2005	Albrant	.....	43/43.12
2009/0113719	A1	*	5/2009	Smith	.....	30/113
2010/0257741	A1	*	10/2010	Lin et al.	.....	30/112

\* cited by examiner

*Primary Examiner* — Celia Murphy

*Assistant Examiner* — John Windmuller

(74) *Attorney, Agent, or Firm* — Kilpatrick Townsend & Stockton LLP

(57) **CLAIM**

The ornamental design for a clip, as shown and described.

**DESCRIPTION**

FIG. 1 is a front perspective view of a clip showing my new design;

FIG. 2 is a rear perspective view thereof;

FIG. 3 is a front elevational view thereof;

FIG. 4 is a rear elevational view thereof;

FIG. 5 is a top plan view thereof;

FIG. 6 is a bottom plan view thereof;

FIG. 7 is right side elevational view thereof;

FIG. 8 is left side elevational view thereof;

FIG. 9 is a front perspective view thereof showing the location of the cross section of FIG. 10; and,

FIG. 10 is a sectional view thereof taken on line 10—10 in FIG. 9.

The broken line showings form no part of the claimed design.

**1 Claim, 6 Drawing Sheets**

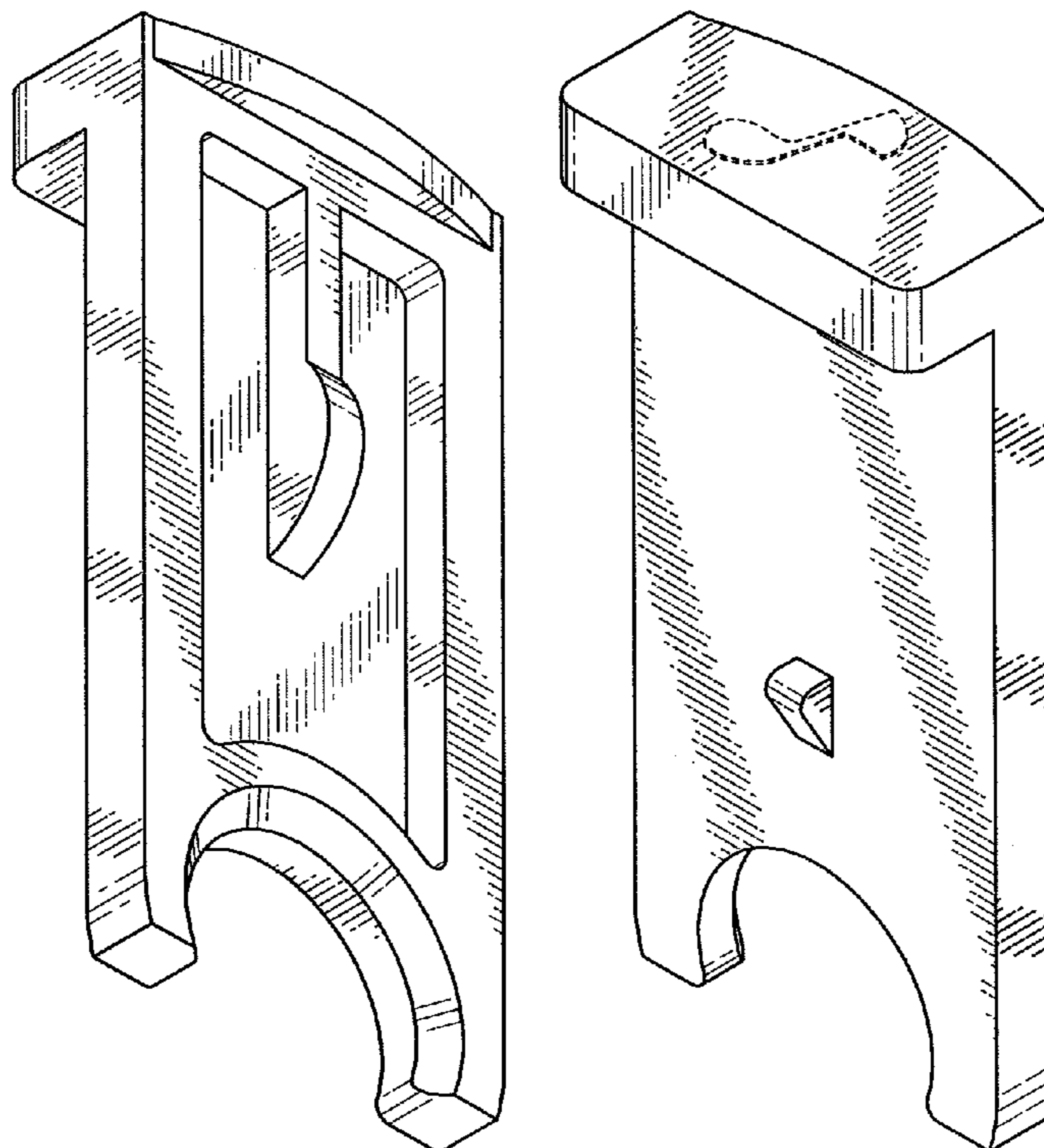

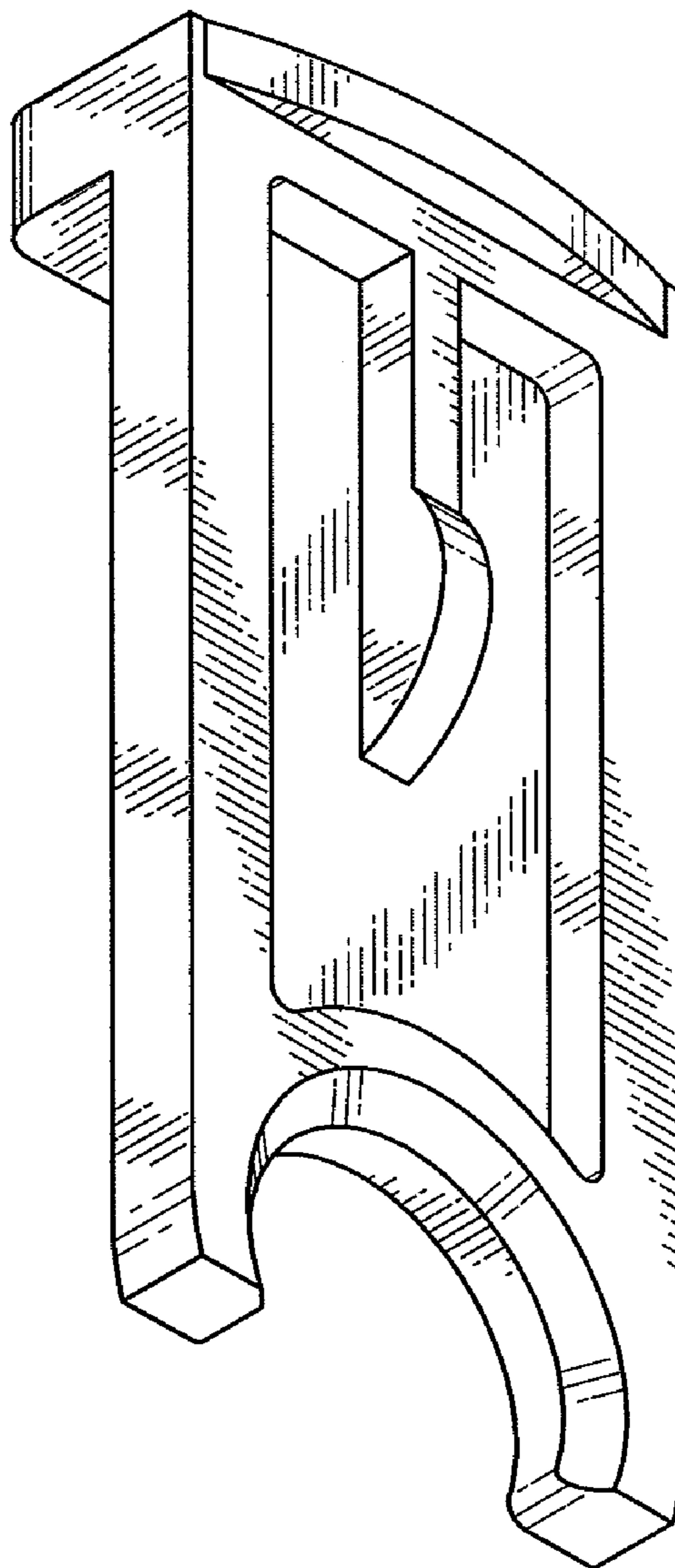

FIG. 1

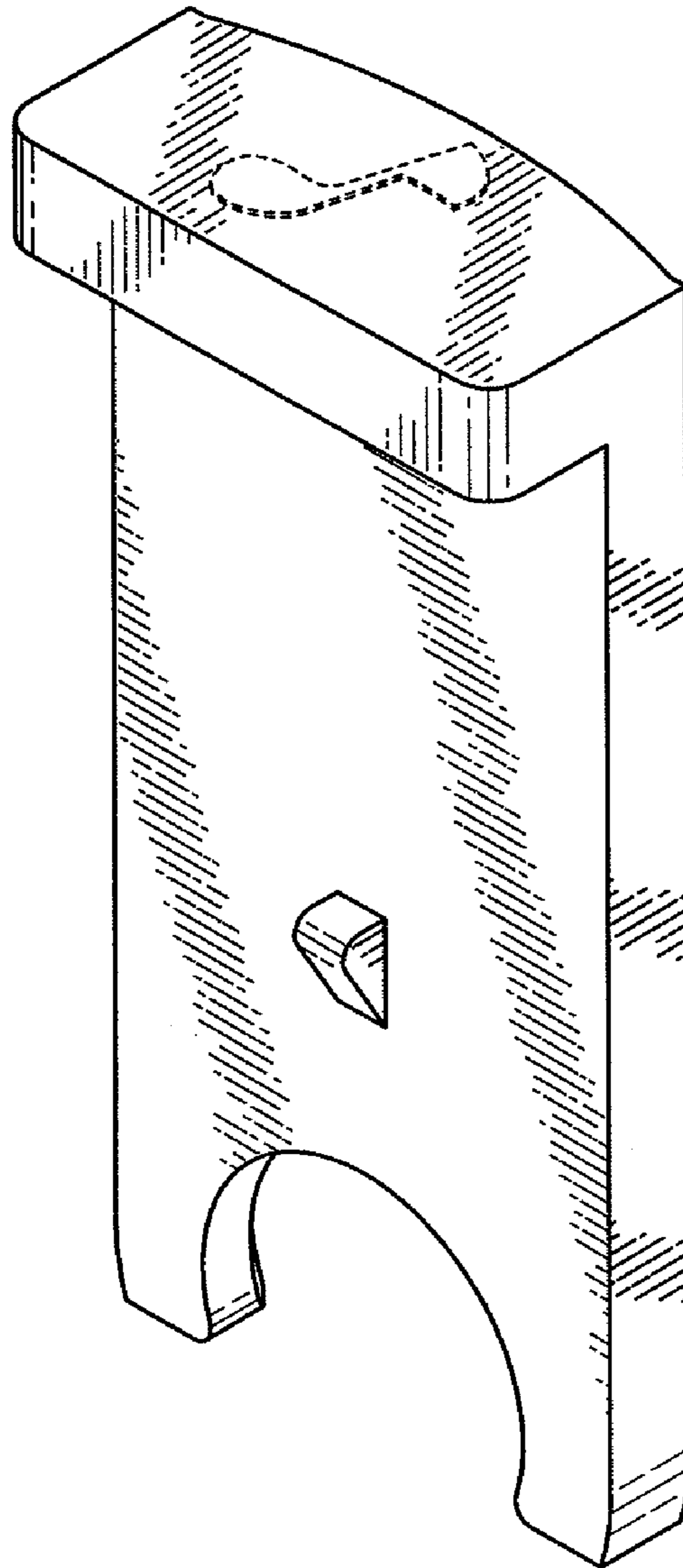

FIG. 2

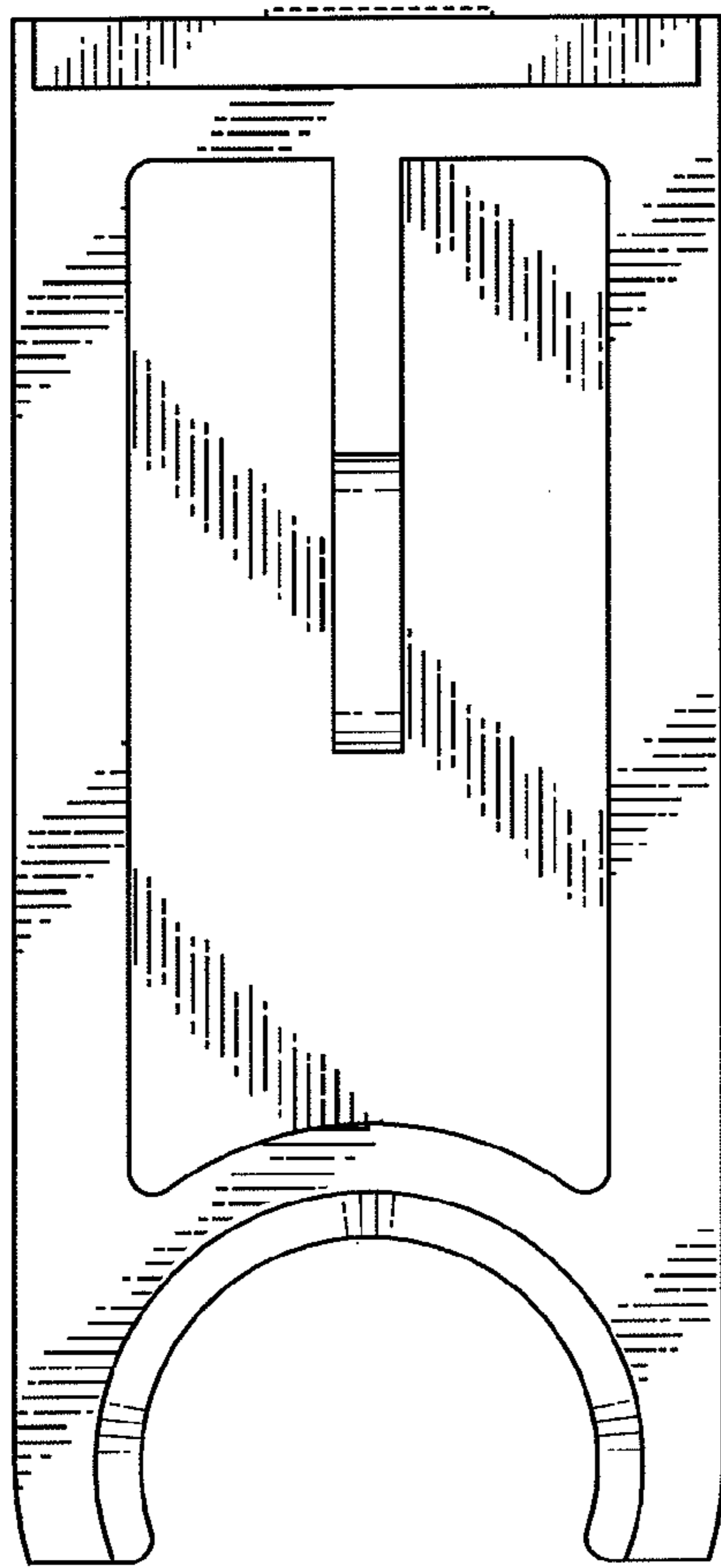

FIG. 3

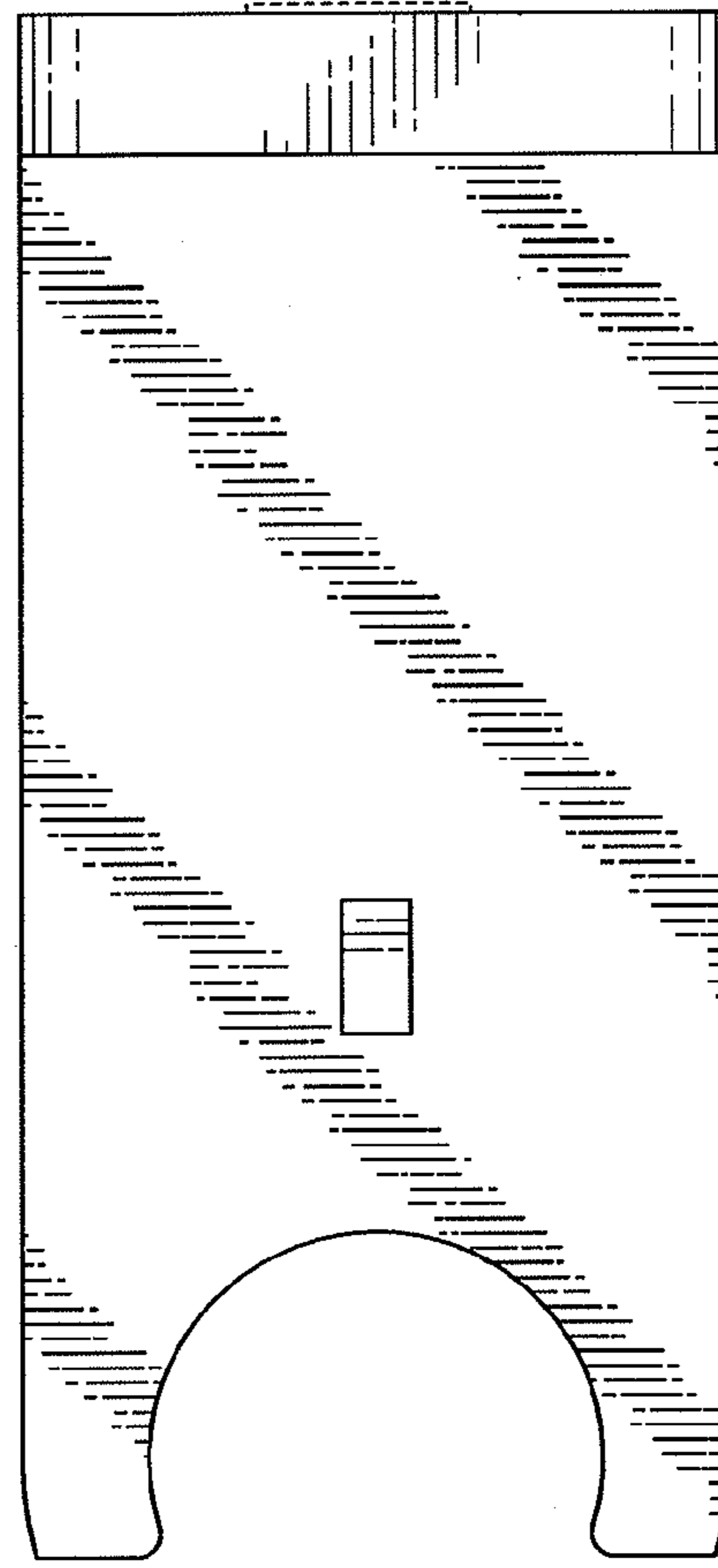

FIG. 4

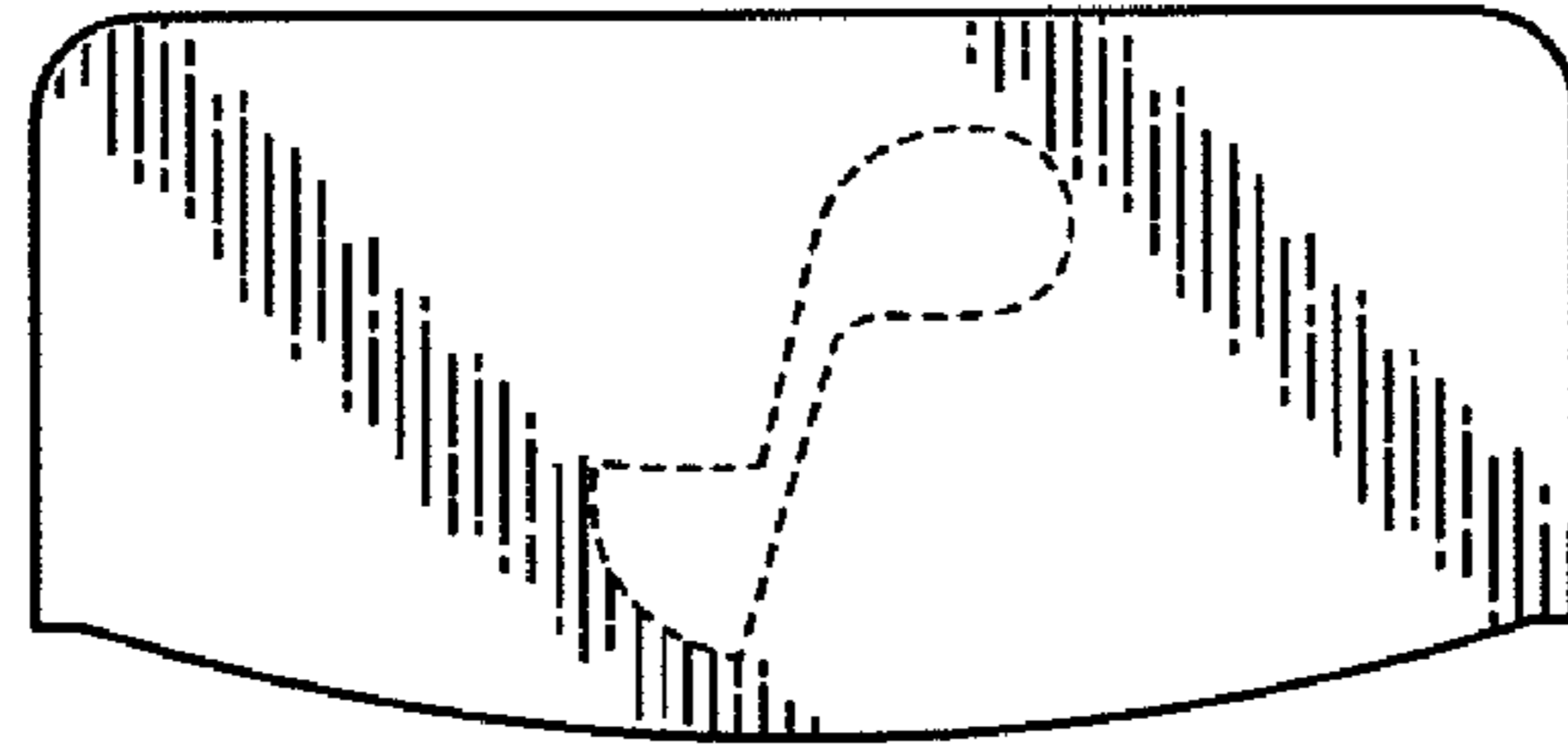

FIG. 5

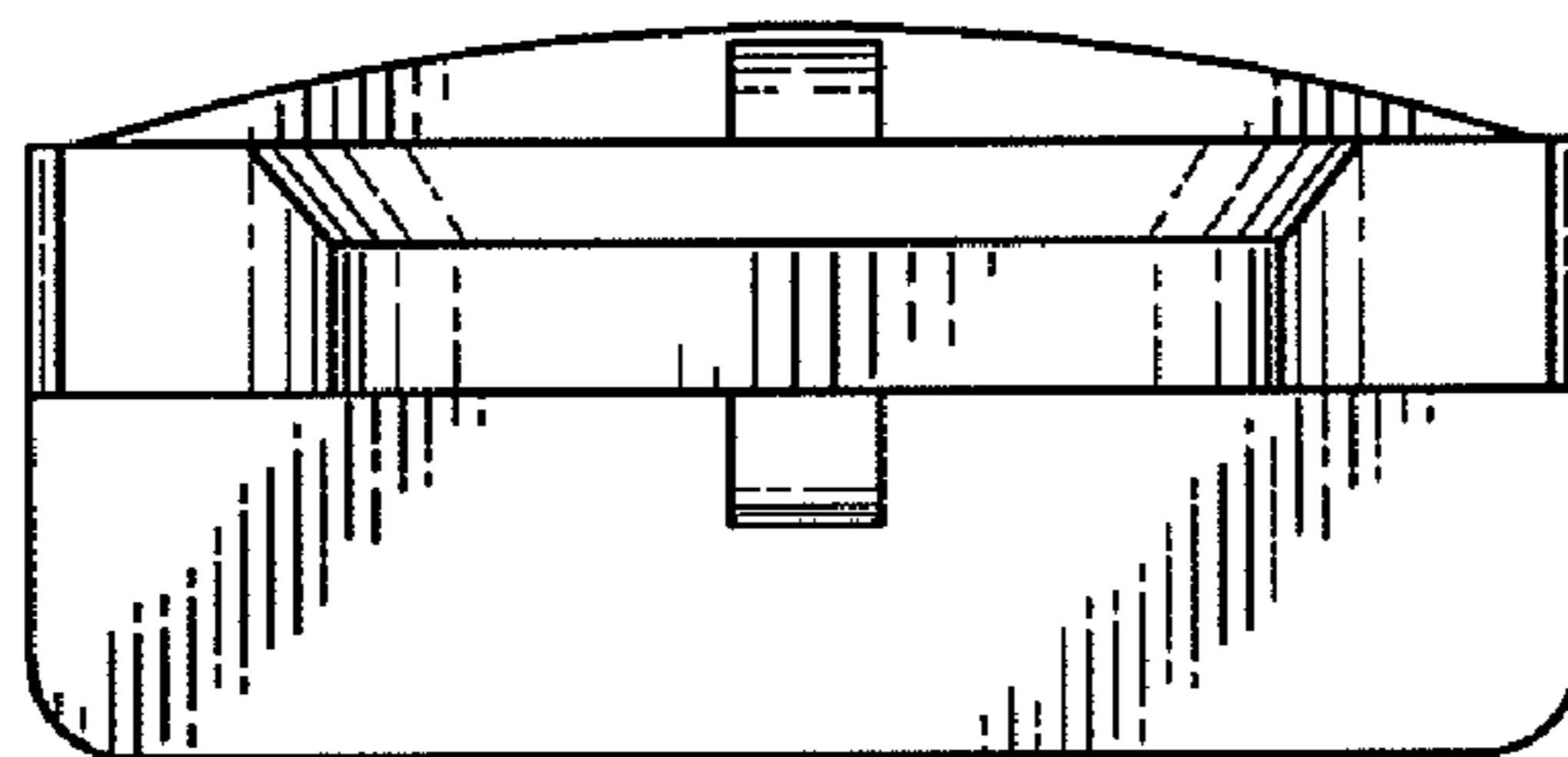

FIG. 6

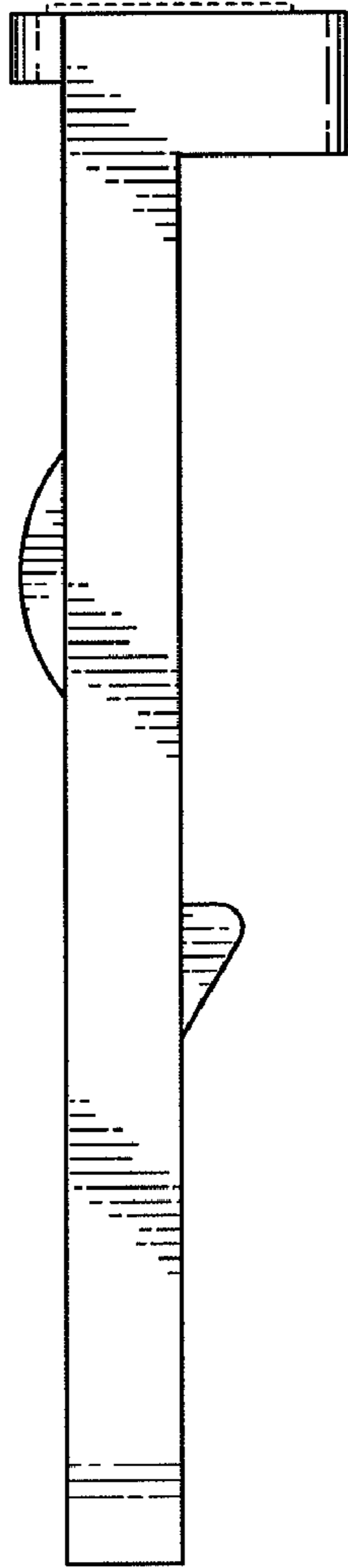

FIG. 7

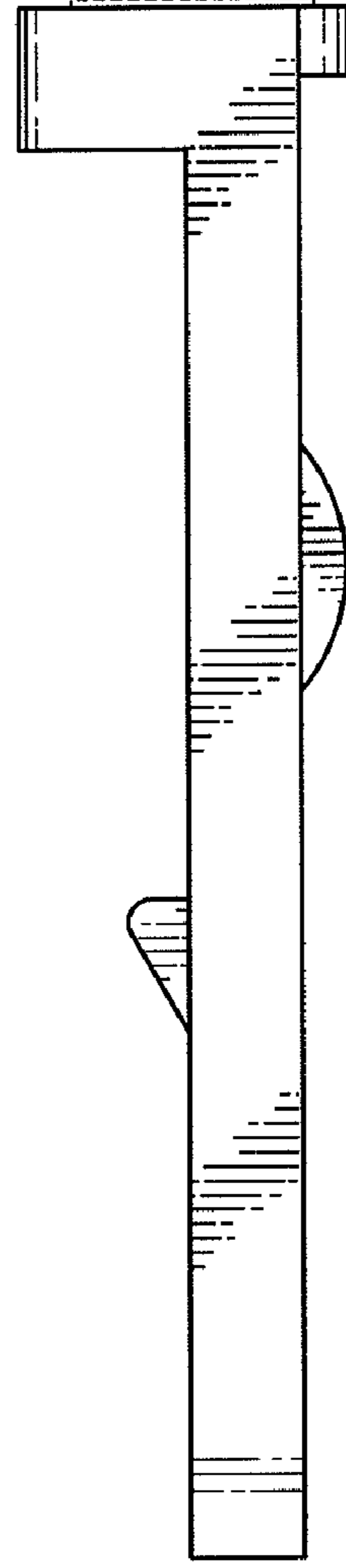

FIG. 8

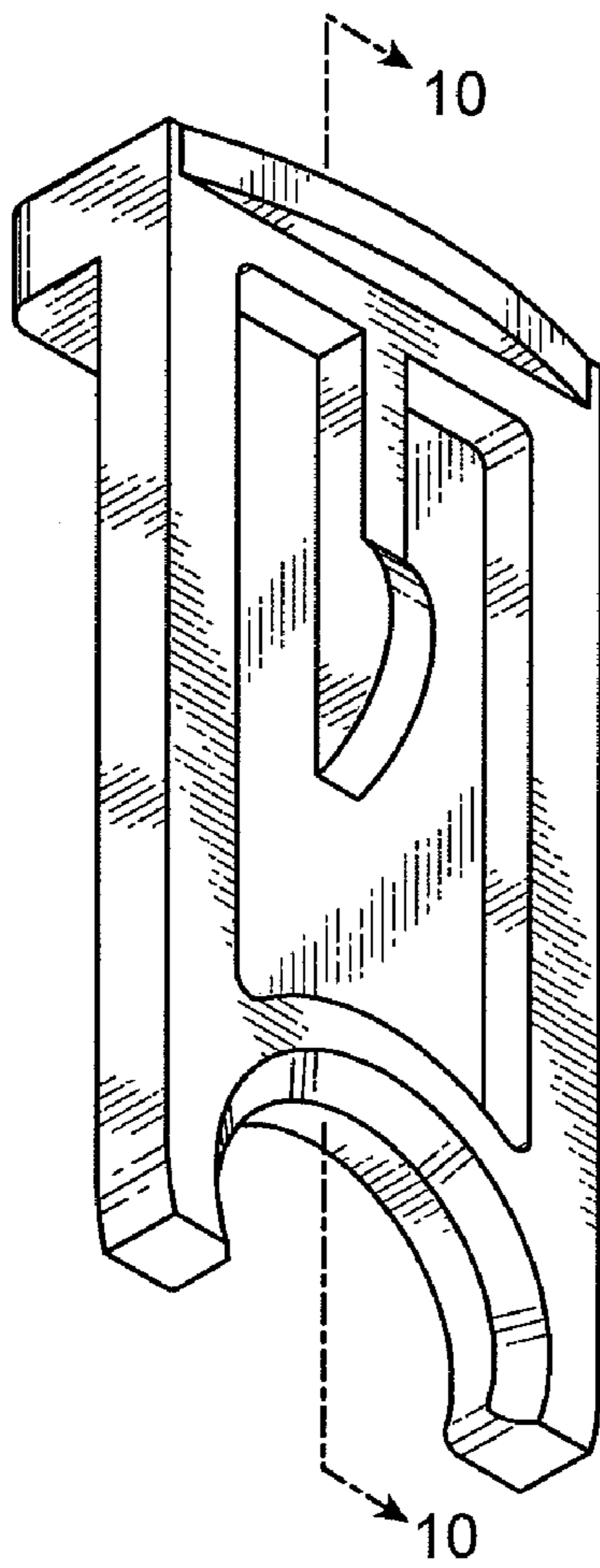

FIG. 9

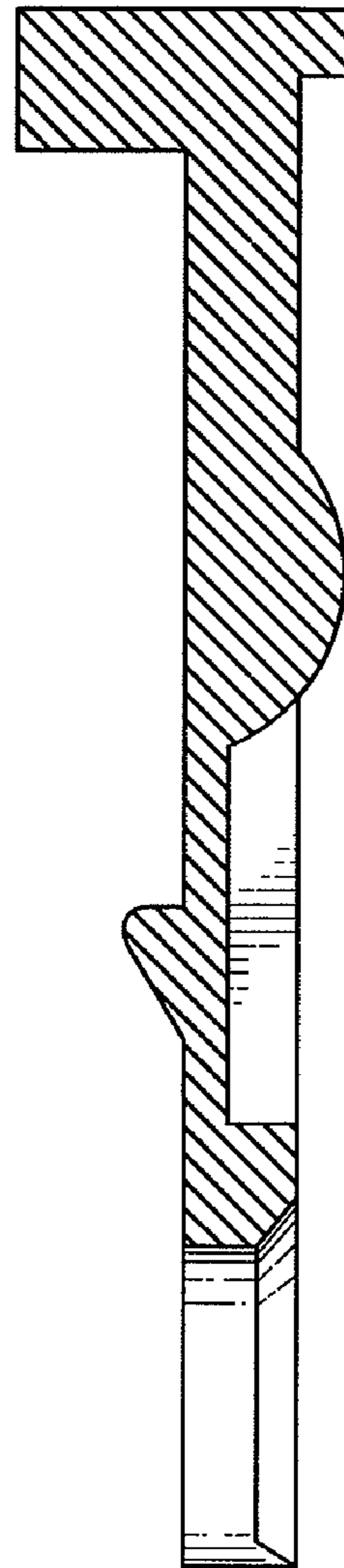

FIG. 10