



US00D643685S

(12) **United States Design Patent**  
**Tiemann**

(10) **Patent No.:** **US D643,685 S**

(45) **Date of Patent:** **\*\* Aug. 23, 2011**

(54) **STACKED BASKETS FOR HOLDING BEVERAGE CARTRIDGES**

(75) **Inventor:** **Frank R. Tiemann**, Madison Lake, MN (US)

(73) **Assignee:** **Nifty Home Products, Inc.**, Madison Lake, MN (US)

(\*\*) **Term:** **14 Years**

(21) **Appl. No.:** **29/382,498**

(22) **Filed:** **Jan. 4, 2011**

(51) **LOC (9) Cl.** ..... **07-06**

(52) **U.S. Cl.** ..... **D7/600.4; D6/465; D6/566**

(58) **Field of Classification Search** ..... D7/600.1-600.4, D7/704, 409, 584-587; D6/407, 449, 462-467, D6/474-476, 511, 525, 537, 540, 566, 567, D6/572, 574; D19/86, 92; D3/304, 306; D32/55, 58; 211/13.1, 191.1, 41.4, 86.01, 211/88.01

See application file for complete search history.

(56) **References Cited**

**U.S. PATENT DOCUMENTS**

D358,507 S \* 5/1995 Goodman et al. .... D6/462  
D371,228 S \* 6/1996 Monin ..... D7/601

D414,306 S \* 9/1999 Hollinger ..... D32/55  
D479,272 S \* 9/2003 Hardy et al. .... D19/92  
D528,877 S \* 9/2006 Goodman et al. .... D7/704  
D548,896 S \* 8/2007 Stewart ..... D30/131  
D601,859 S \* 10/2009 Janvier ..... D7/609  
D613,093 S \* 4/2010 Snider ..... D6/462  
D629,258 S 12/2010 Tiemann

\* cited by examiner

*Primary Examiner* — Terry A Wallace

(74) *Attorney, Agent, or Firm* — Thomas J. Nikolai; Nikolai & Mersereau, P.A.

(57) **CLAIM**

The ornamental design for the “stacked baskets for holding beverage cartridges,” as shown and described.

**DESCRIPTION**

FIG. 1 is a perspective view of the stacked baskets for holding beverage cartridges;  
FIG. 2 is a front view thereof;  
FIG. 3 is a top view thereof;  
FIG. 4 is a side view thereof;  
FIG. 5 is a back view thereof;  
FIG. 6 is a second side view thereof; and,  
FIG. 7 is a bottom view thereof.

**1 Claim, 7 Drawing Sheets**

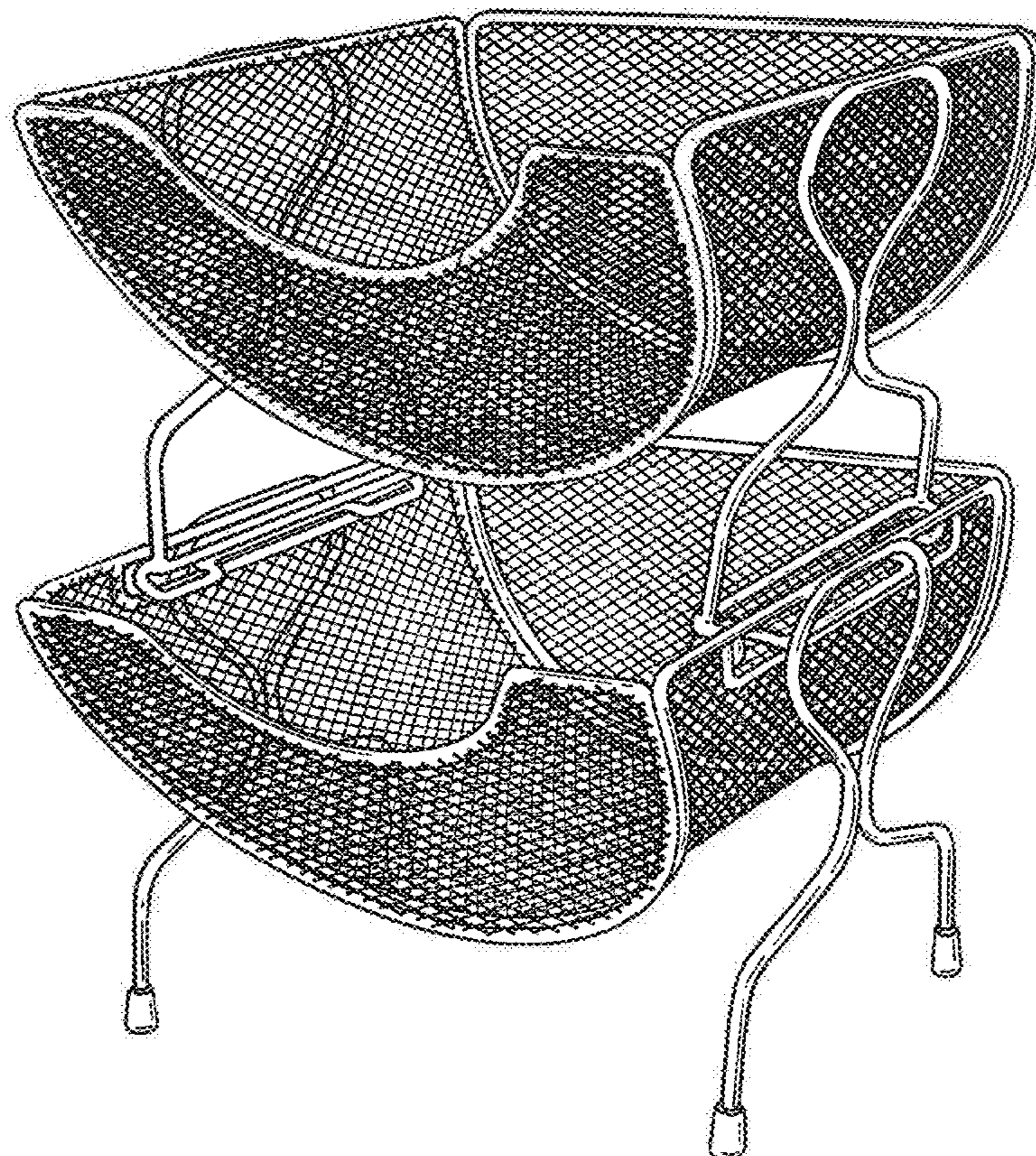

FIG. 1

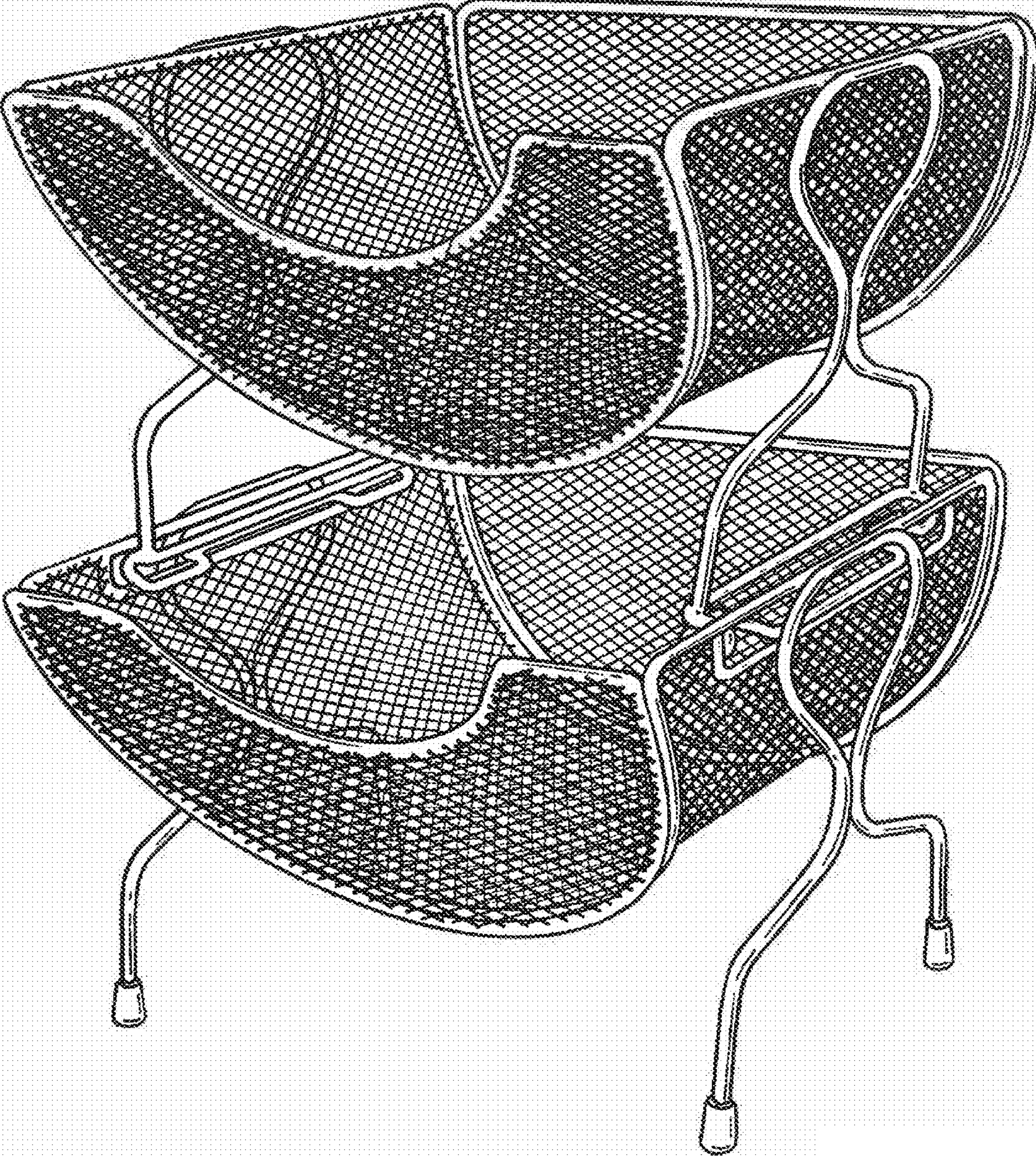
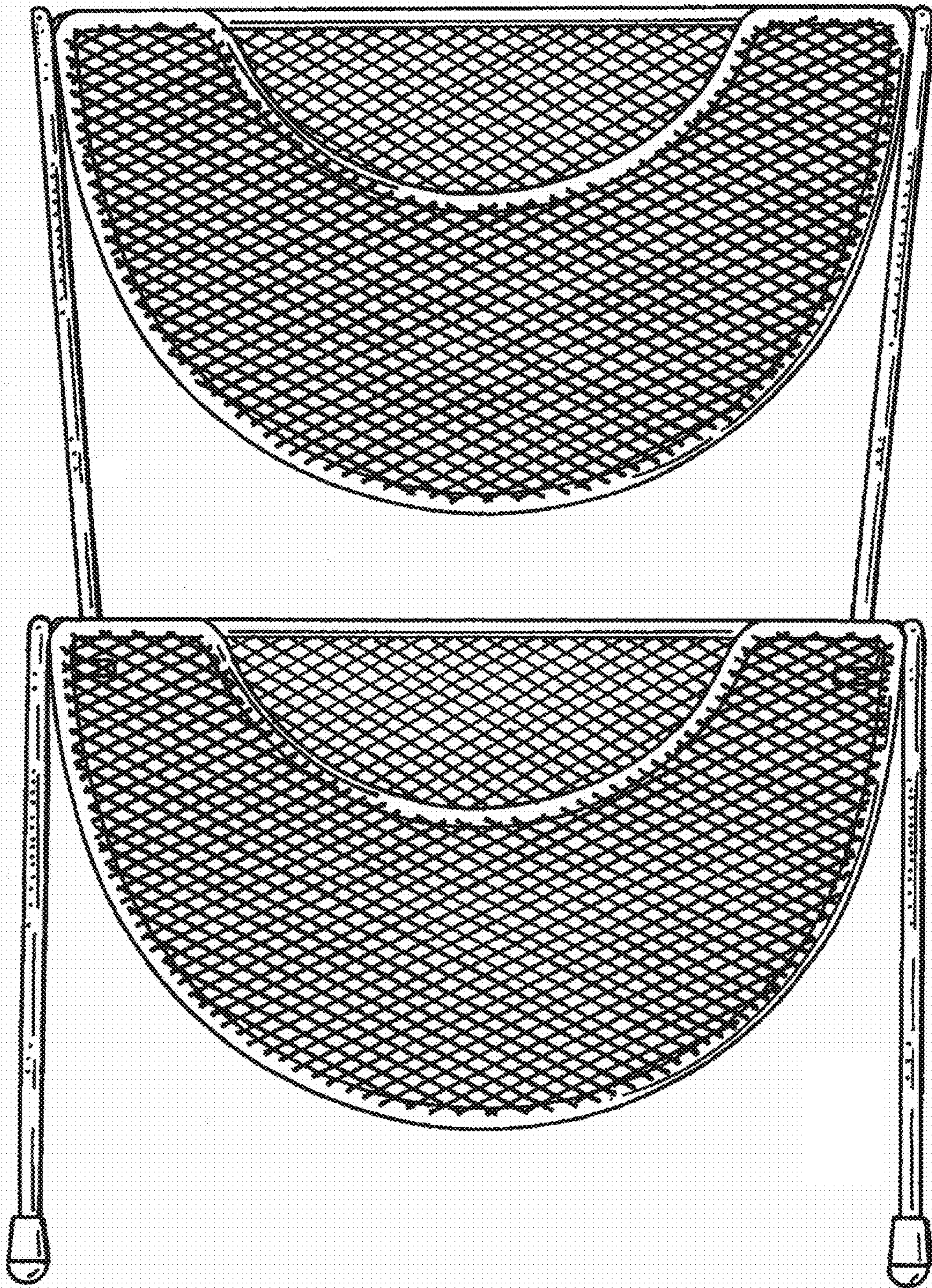

FIG. 2



*FIG. 3*

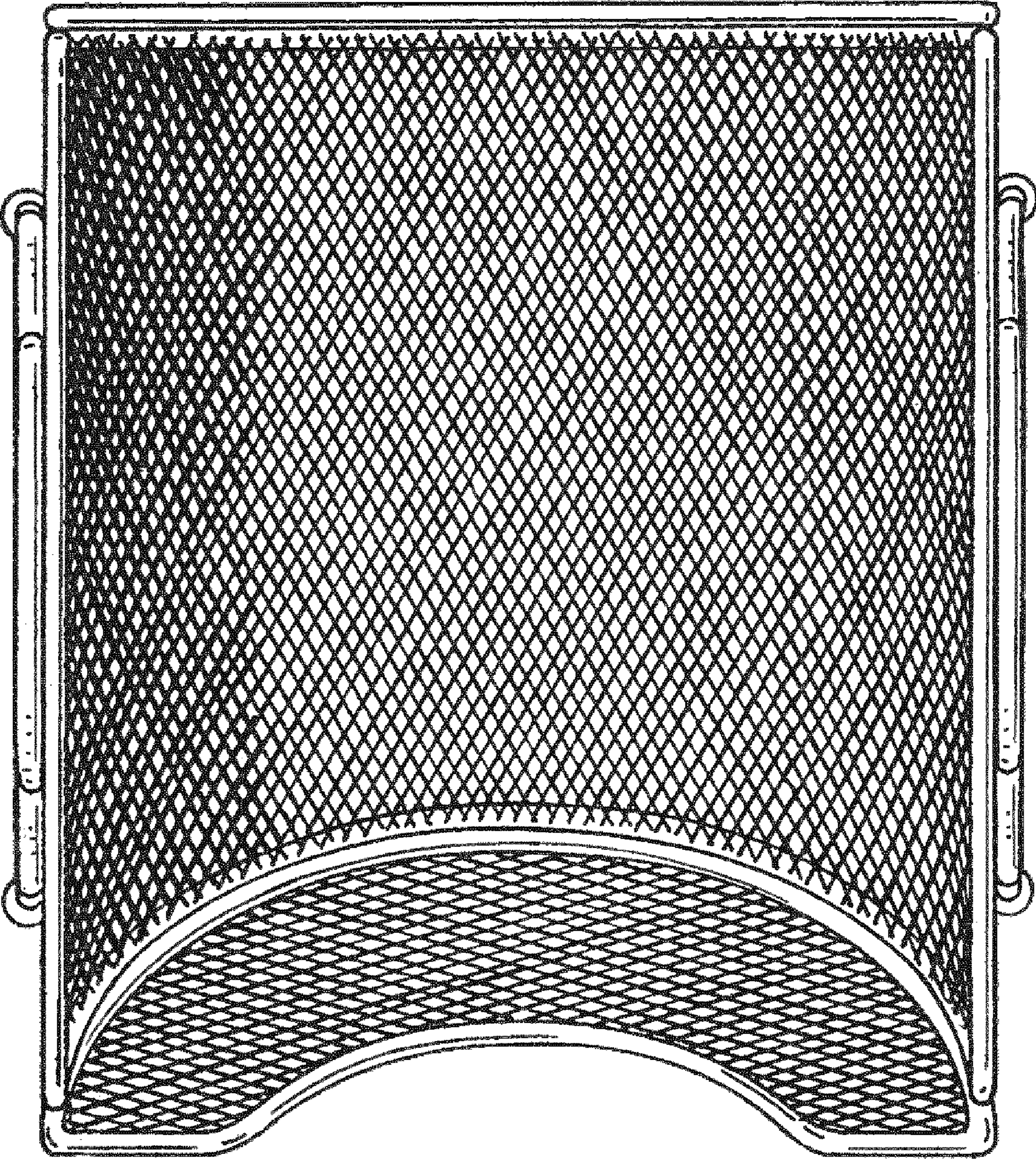

FIG. 4

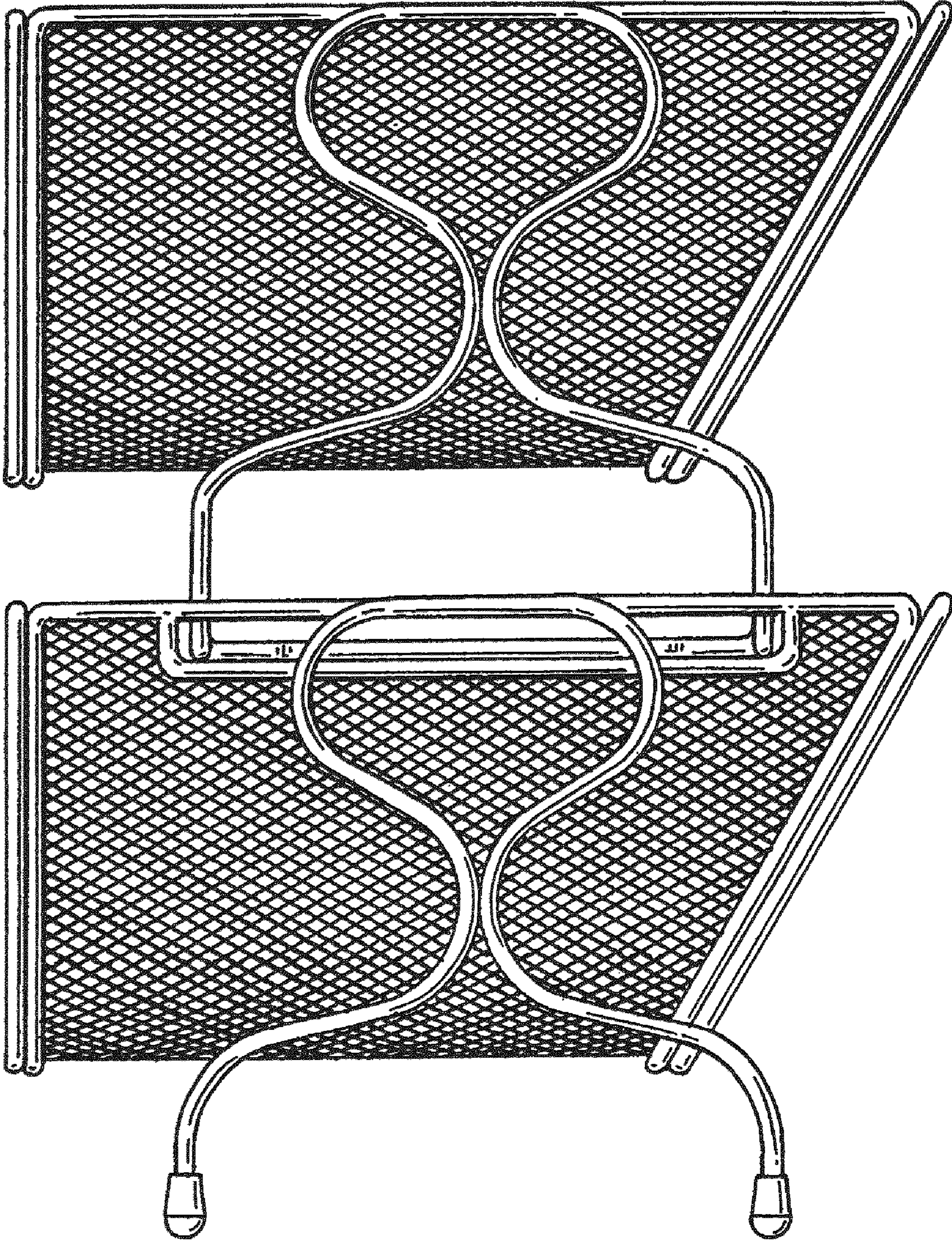

FIG. 5

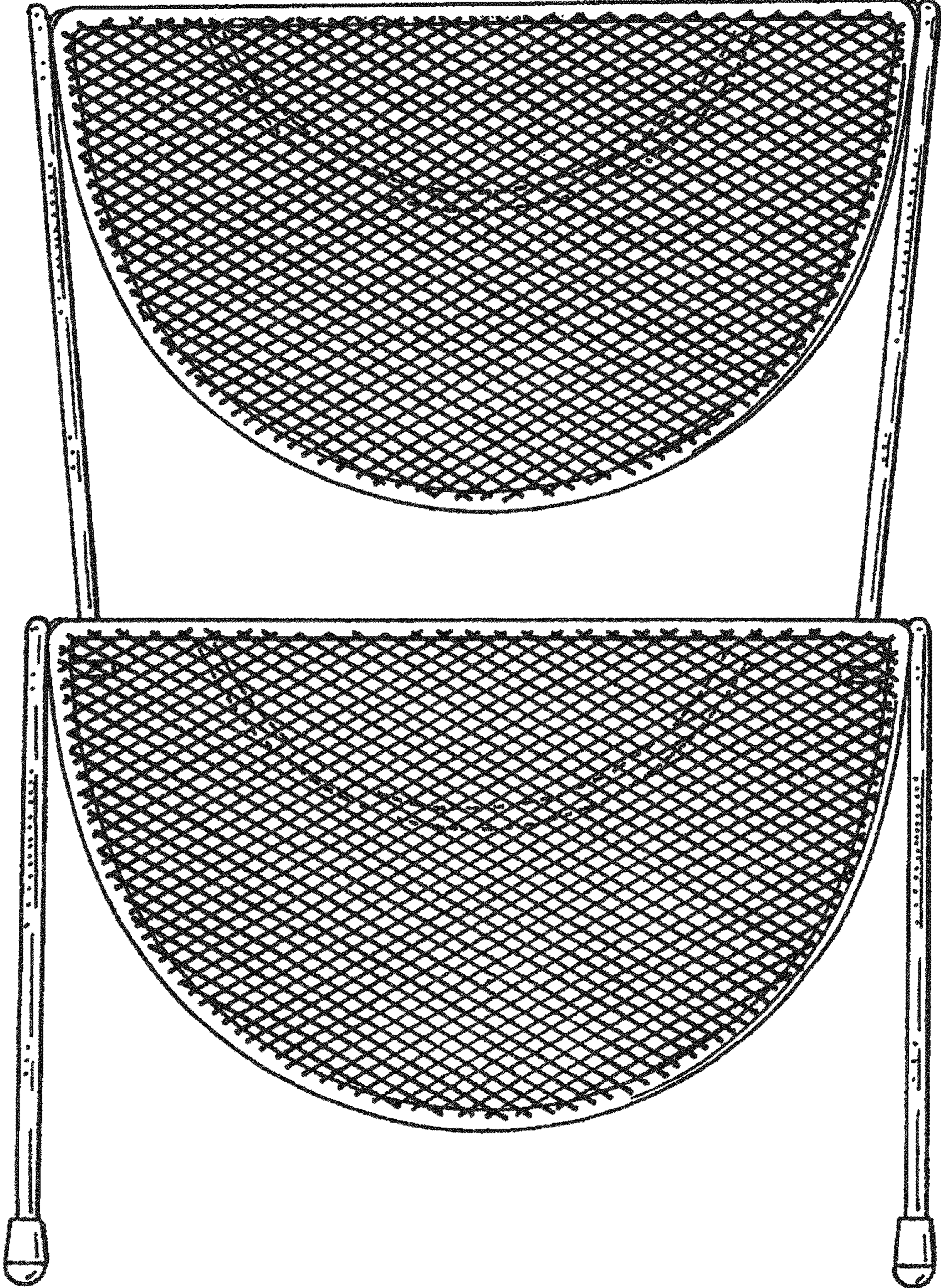

FIG. 6

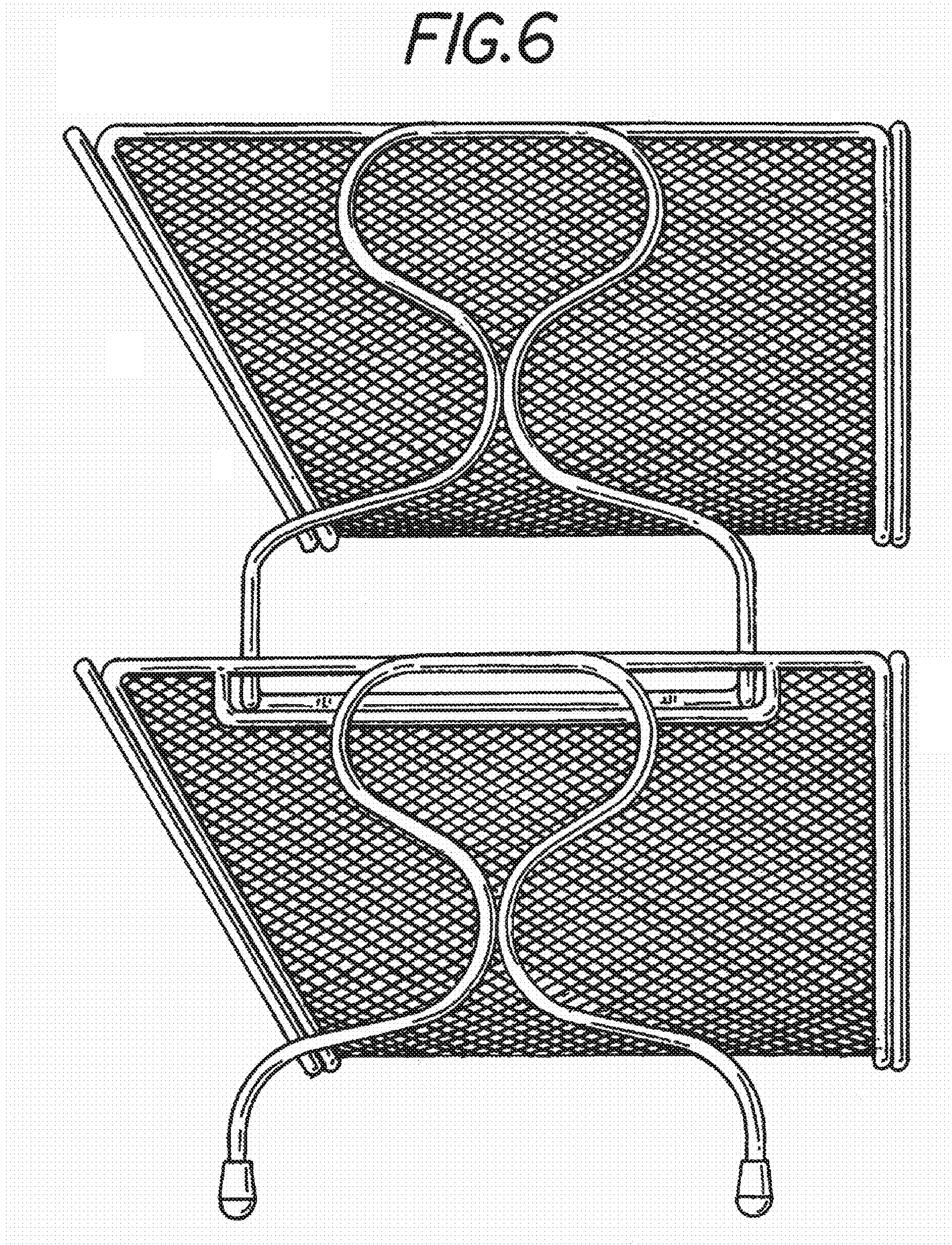

FIG. 7

