



US00D643578S

(12) **United States Design Patent**  
**Jefferson et al.**

(10) **Patent No.:** **US D643,578 S**

(45) **Date of Patent:** **\*\* Aug. 16, 2011**

(54) **PROTECTIVE HEADGEAR DEVICE**

(75) Inventors: **William D. Jefferson**, Greenwood, SC  
(US); **Norman J. Cockrell**, Waterloo,  
SC (US)

(73) Assignee: **Ryano-Guard, LLC**, Waterloo, SC (US)

(\*\*) Term: **14 Years**

(21) Appl. No.: **29/357,226**

(22) Filed: **Mar. 9, 2010**

(51) **LOC (9) Cl.** ..... **29-02**

(52) **U.S. Cl.** ..... **D29/112**

(58) **Field of Classification Search** ..... D29/102-106,  
D29/108, 110, 112, 122; 2/455, DIG. 11,  
2/174, 410, 423-425, 209; D2/869-870,  
D2/874

See application file for complete search history.

(56) **References Cited**

**U.S. PATENT DOCUMENTS**

2,435,100	A *	1/1948	Rasmussen	.....	2/174
D215,138	S *	9/1969	Mackey	.....	D29/112
4,982,451	A *	1/1991	Graham	.....	2/410
D315,812	S *	3/1991	Cionni	.....	D29/112
D375,825	S *	11/1996	Whidden	.....	D2/866
D446,609	S *	8/2001	Hill	.....	D29/112
D478,692	S *	8/2003	Gessner	.....	D29/112
D547,500	S *	7/2007	Karrman	.....	D29/112
2002/0170106	A1 *	11/2002	Ducker Lebherz	.....	2/423
2008/0307562	A1 *	12/2008	Tipp	.....	2/209
2008/0307565	A1 *	12/2008	Le Gette et al.	.....	2/209
2009/0013448	A1 *	1/2009	Drosihn	.....	2/209

\* cited by examiner

*Primary Examiner* — Ruth McInroy

(74) *Attorney, Agent, or Firm* — Dority & Manning, P.A.

(57) **CLAIM**

The ornamental design for a protective headgear device, as shown and described.

**DESCRIPTION**

FIG. 1 is a perspective view of a protective headgear device showing our new design;

FIG. 2 is a rear view thereof;

FIG. 3 is a front view thereof;

FIG. 4 is a bottom view thereof;

FIG. 5 is a top view thereof;

FIG. 6 is a right side view thereof;

FIG. 7 is a left side view thereof;

FIG. 8 is a perspective view thereof showing the device in use with a ball cap, the ball cap forming no part of the claimed design;

FIG. 9 is a perspective view thereof showing the device with inside padding and a strap, the padding and strap forming no part of the claimed design;

FIG. 10 is a rear view of FIG. 9;

FIG. 11 is a front view of FIG. 9;

FIG. 12 is a bottom view of FIG. 9;

FIG. 13 is a top view of FIG. 9;

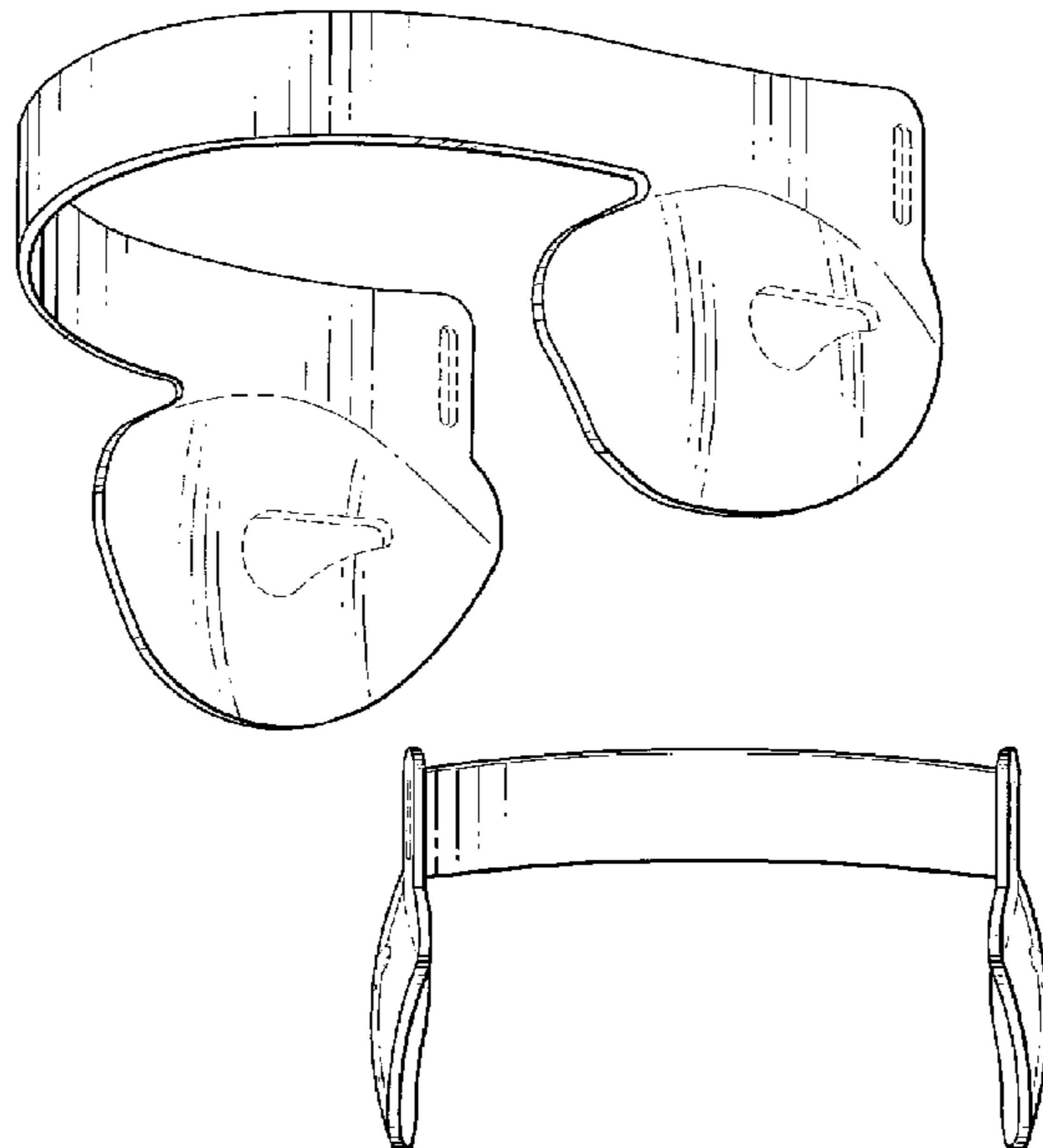
FIG. 14 is a right side view of FIG. 9;

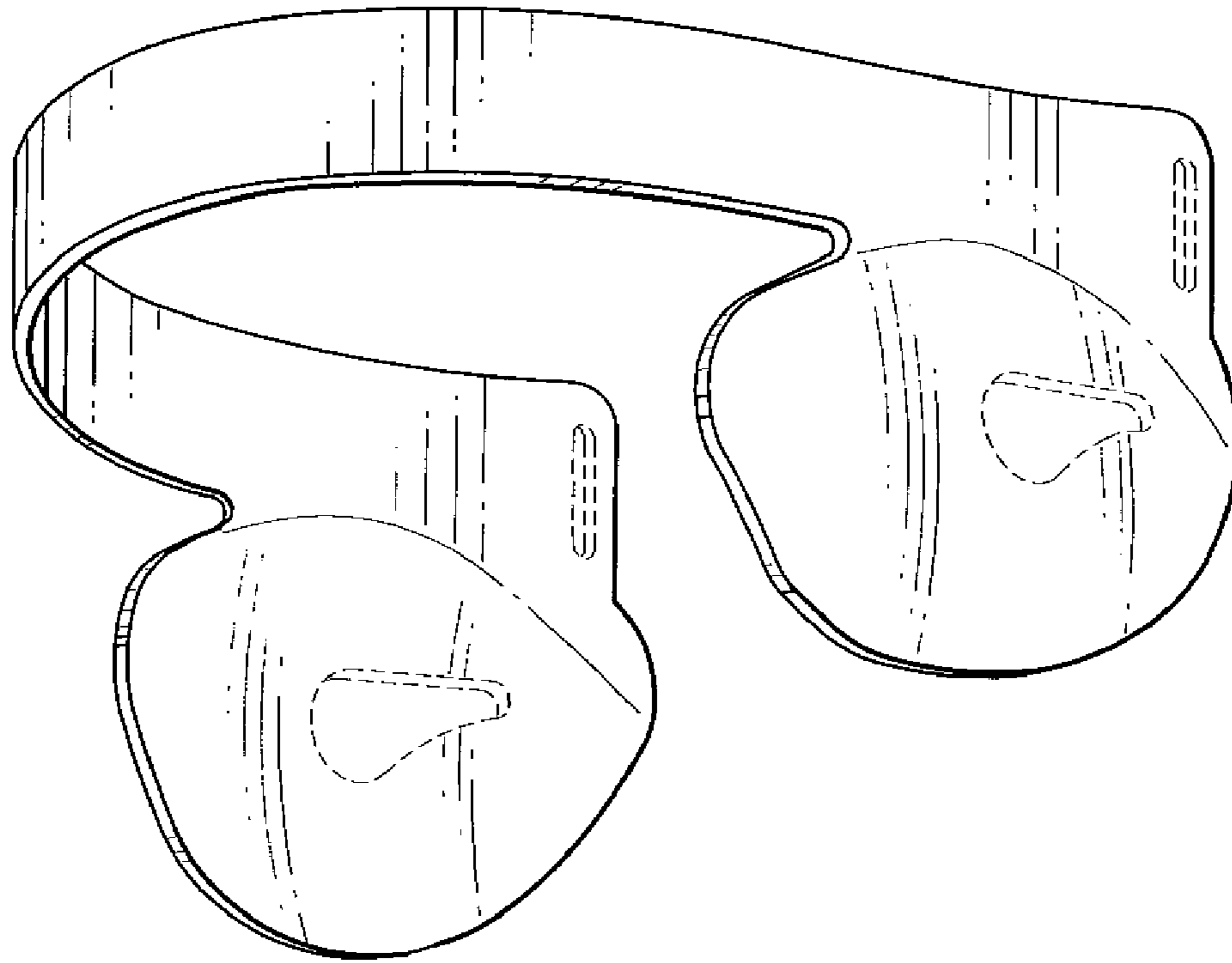
FIG. 15 is a left side view of FIG. 9; and,

FIG. 16 is a perspective view of FIG. 9 with the ball cap, the cap, padding and strap forming no part of the claimed design.

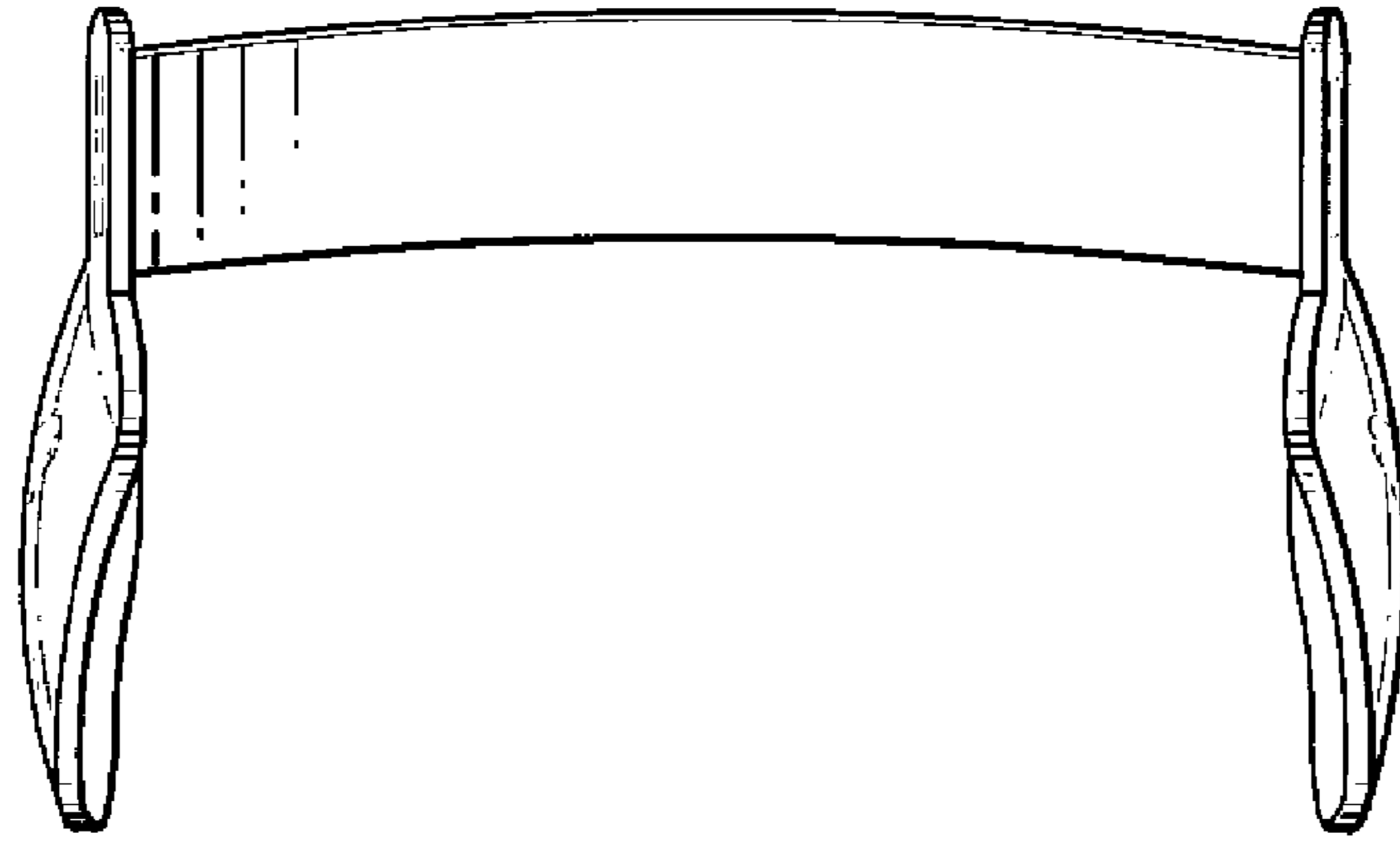
The details shown in broken lines form no part of the claimed design.

**1 Claim, 10 Drawing Sheets**

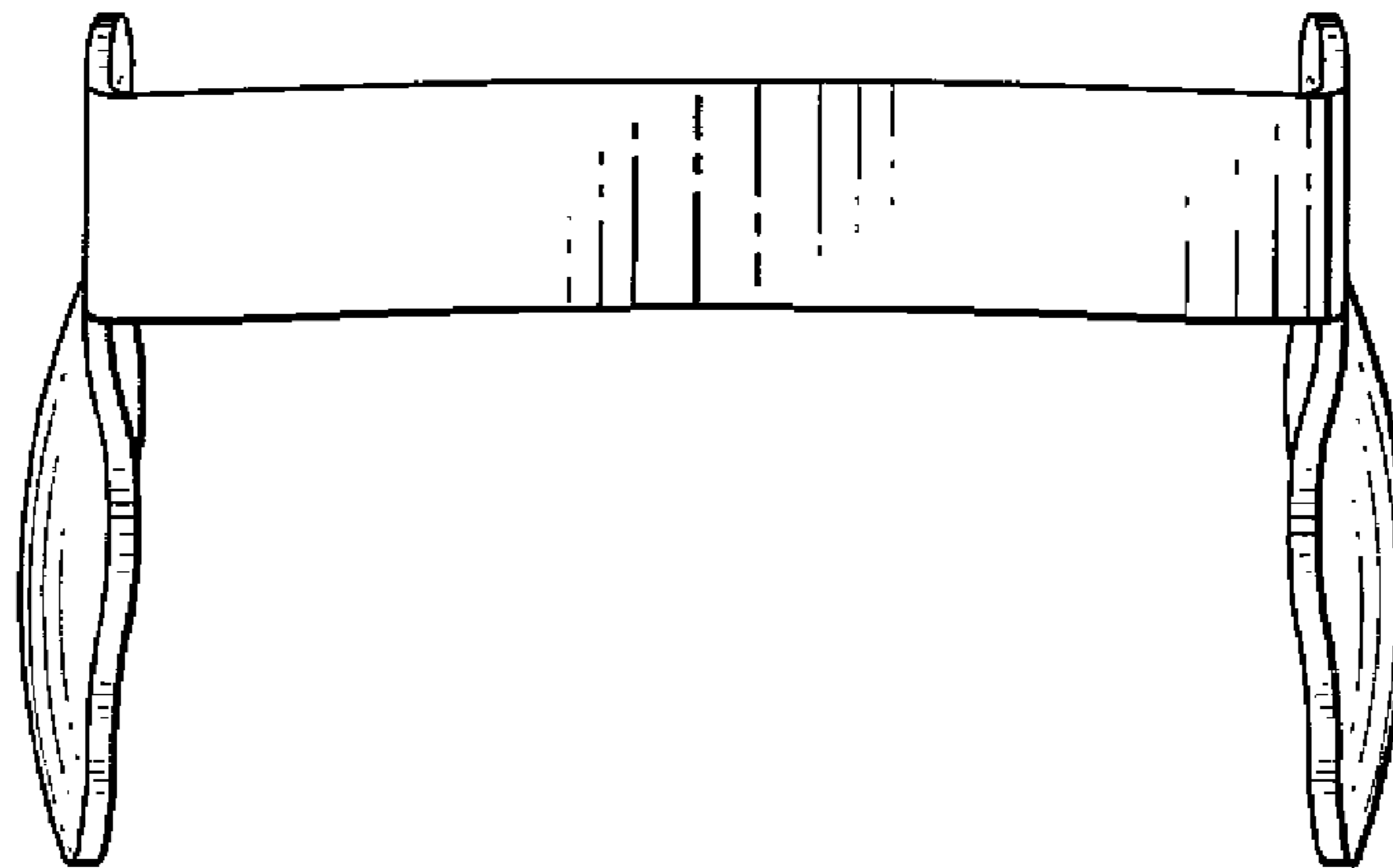




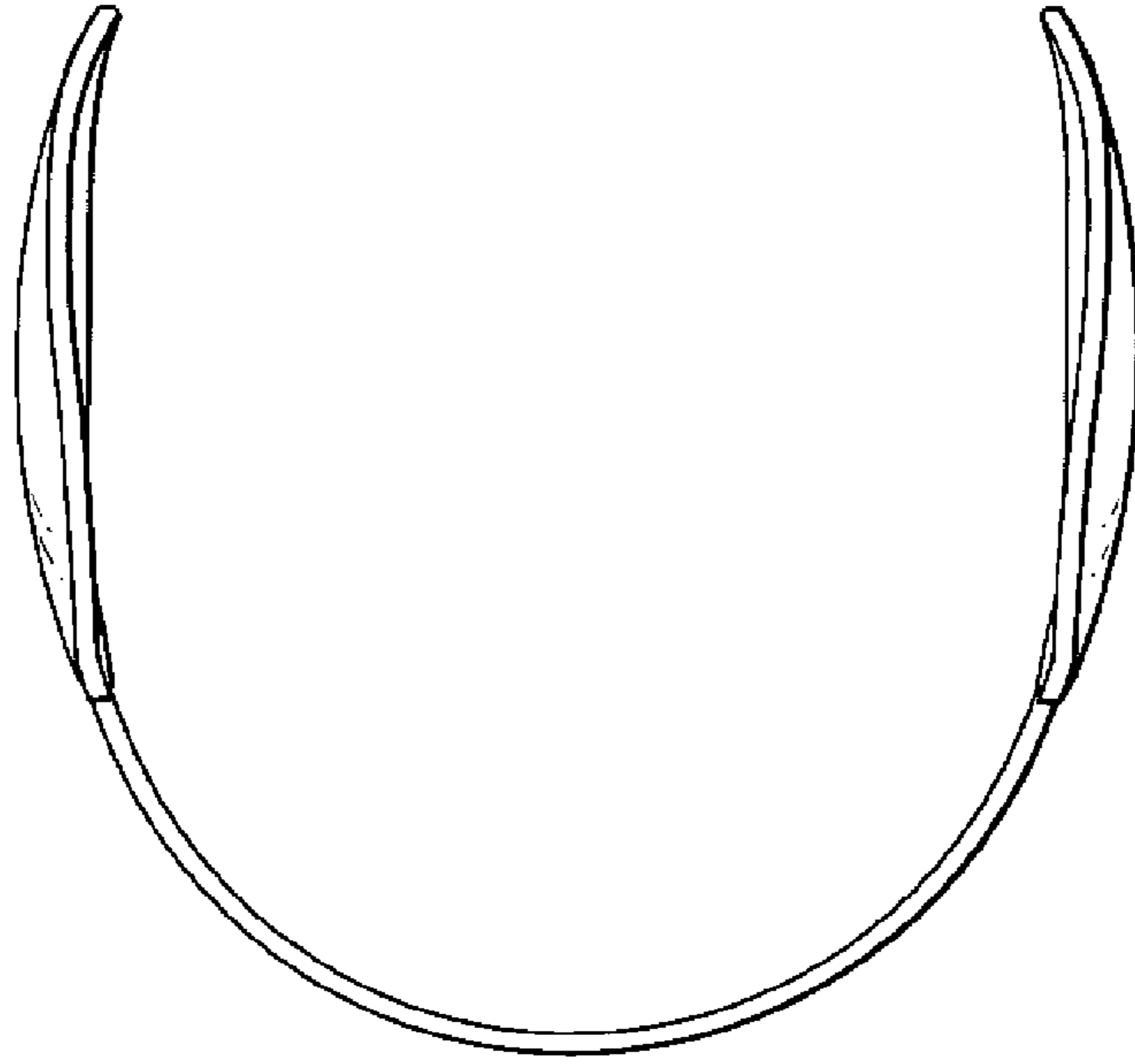
*FIG. -1-*



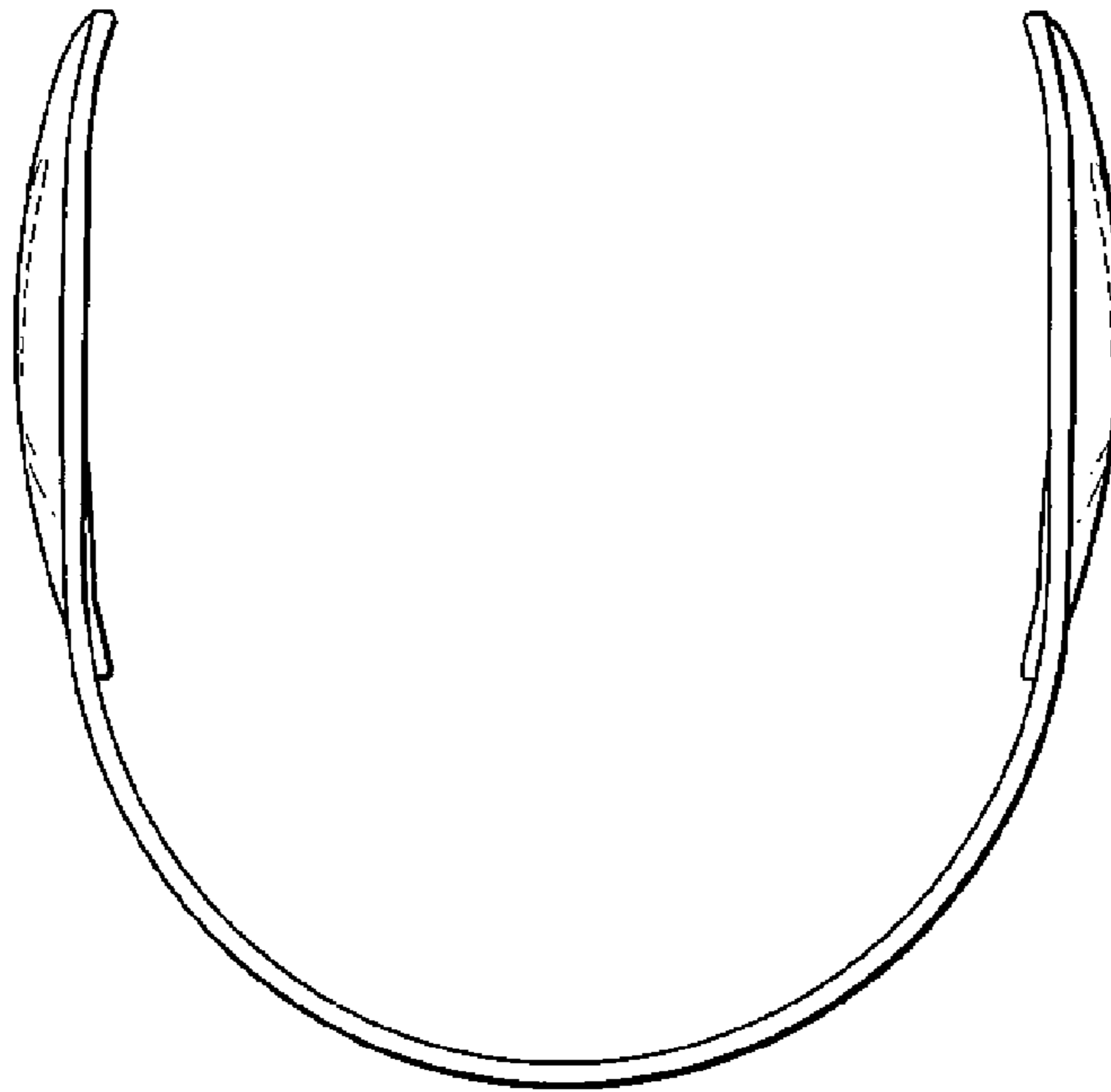
*FIG. -2-*



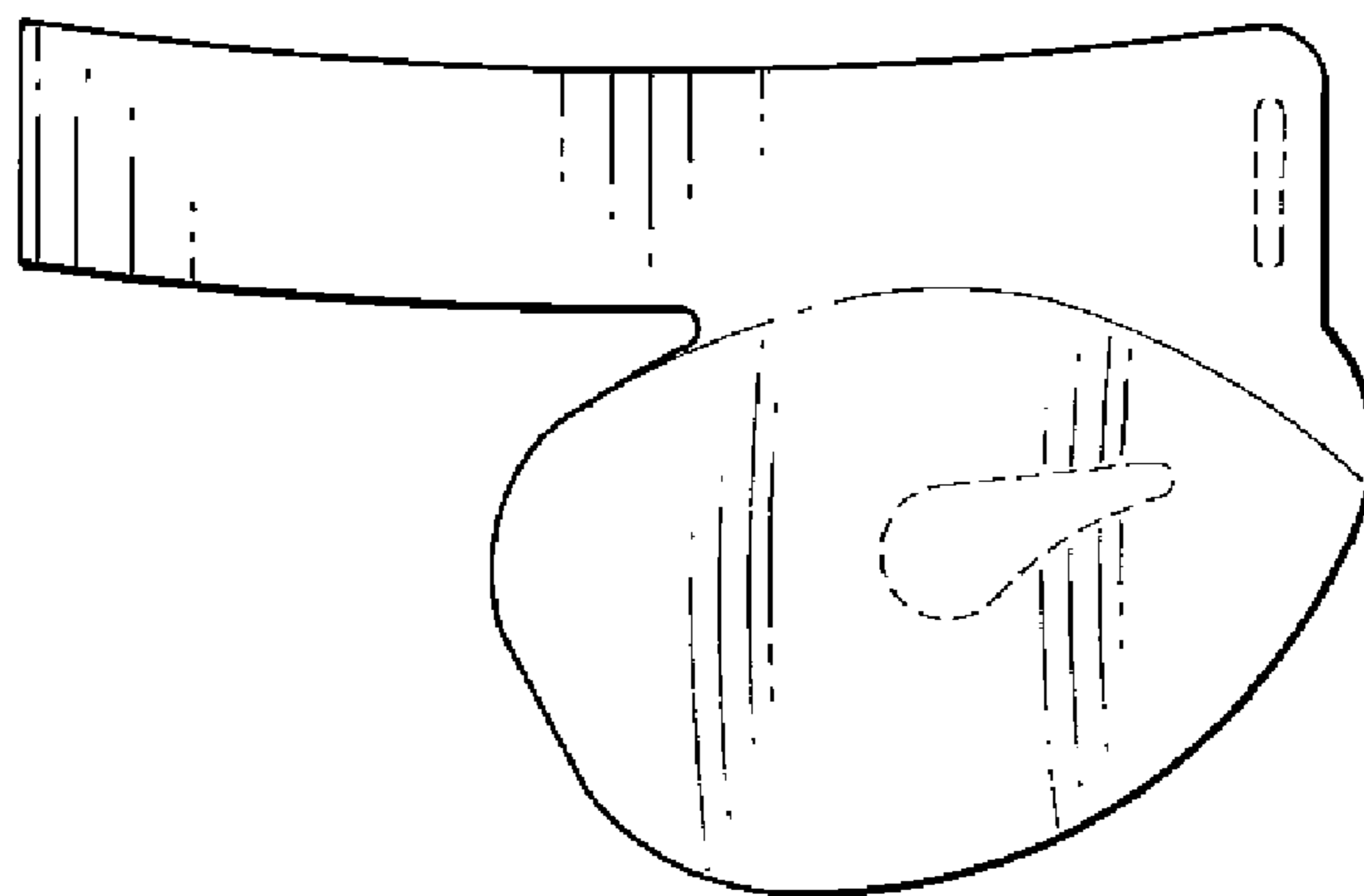
*FIG. -3-*



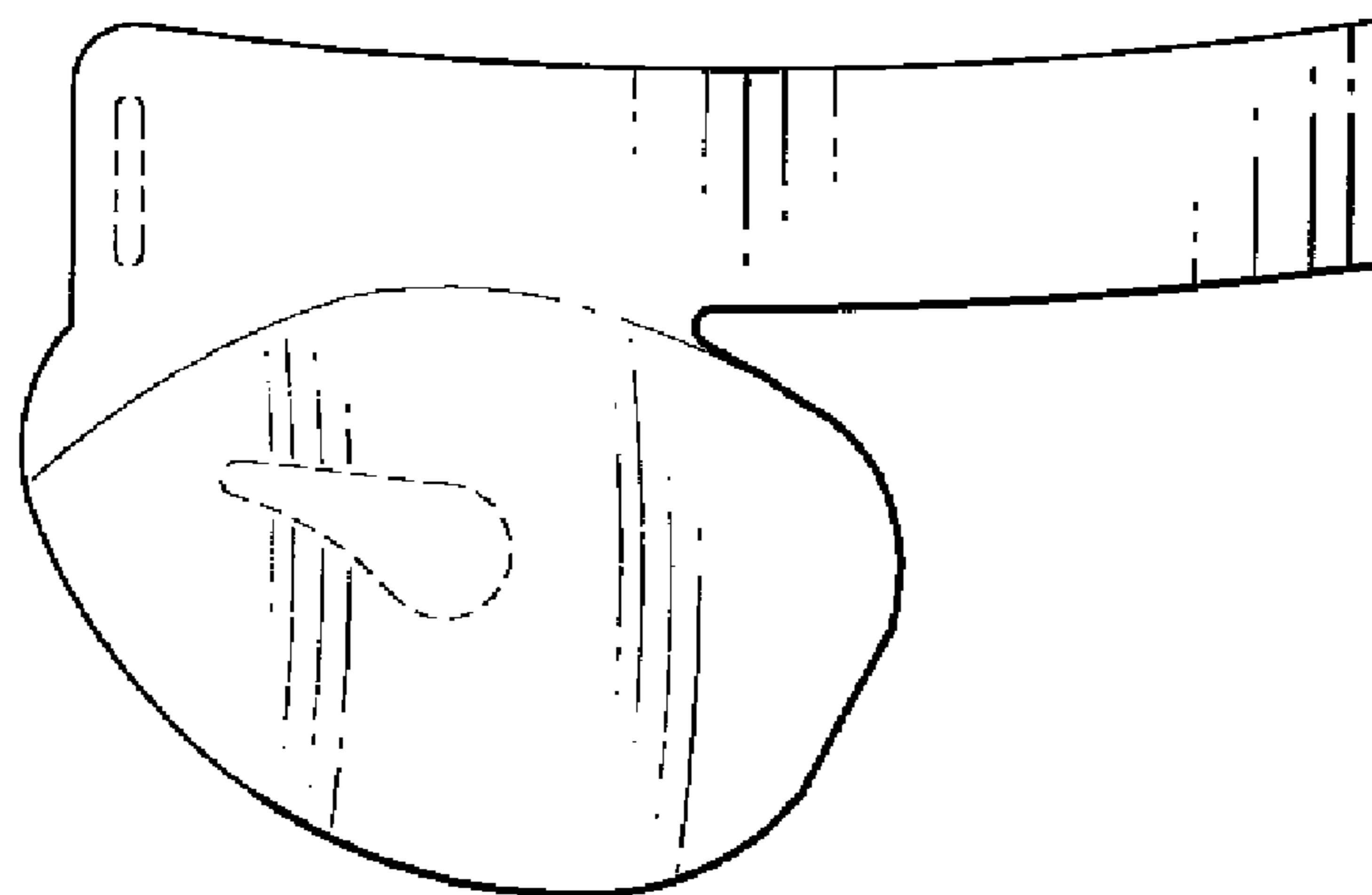
*FIG. -4-*



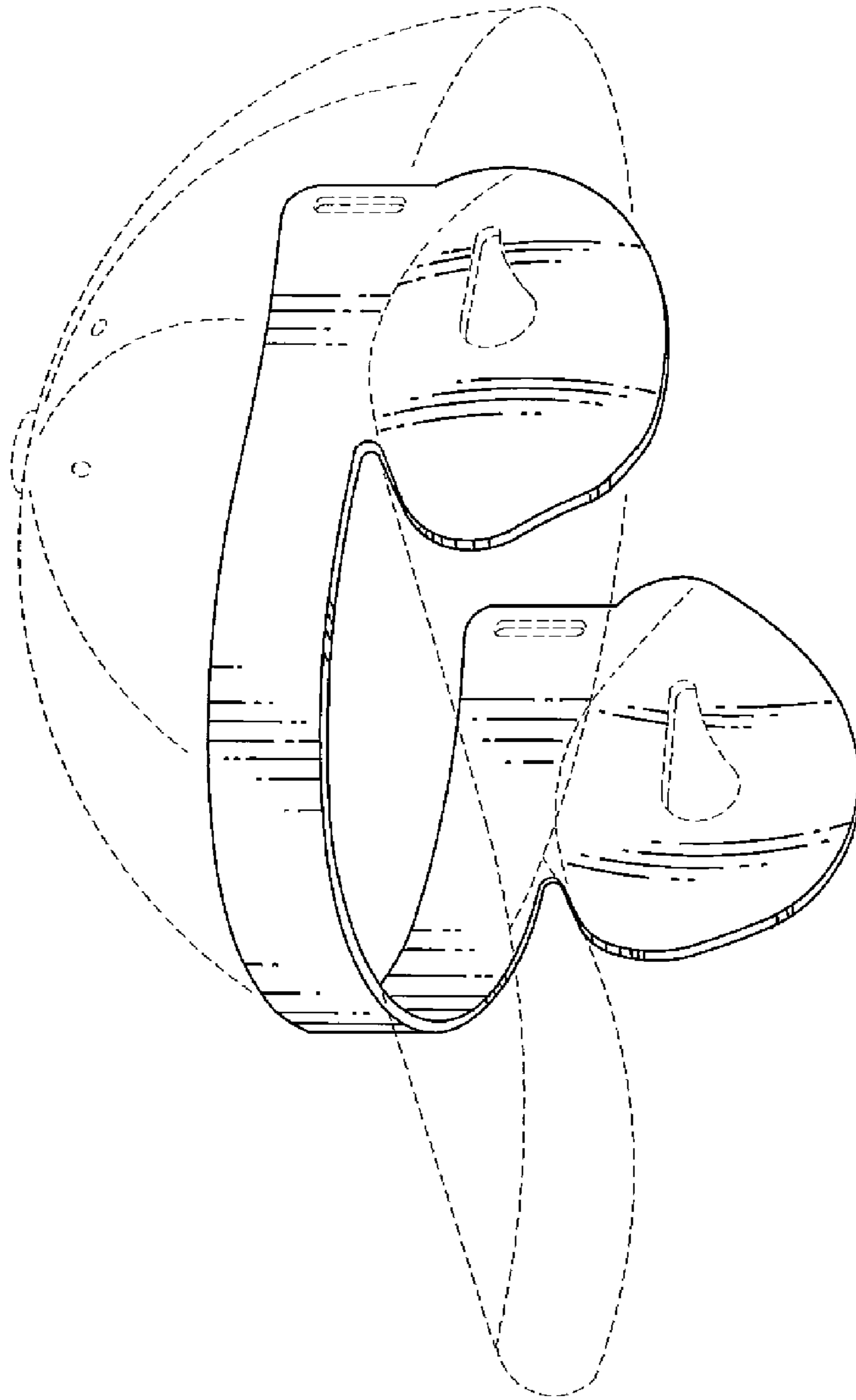
*FIG. -5-*



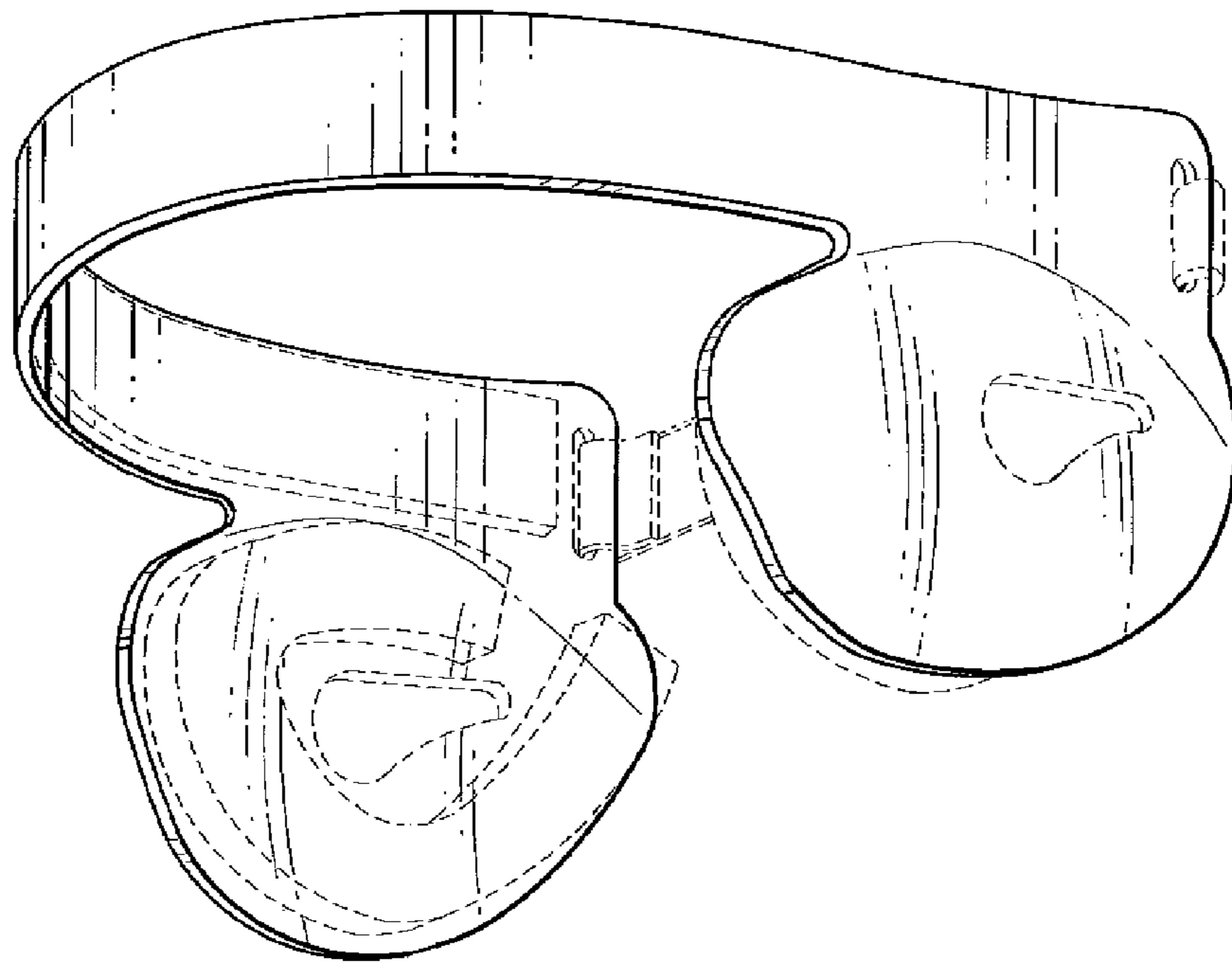
*FIG. -6-*



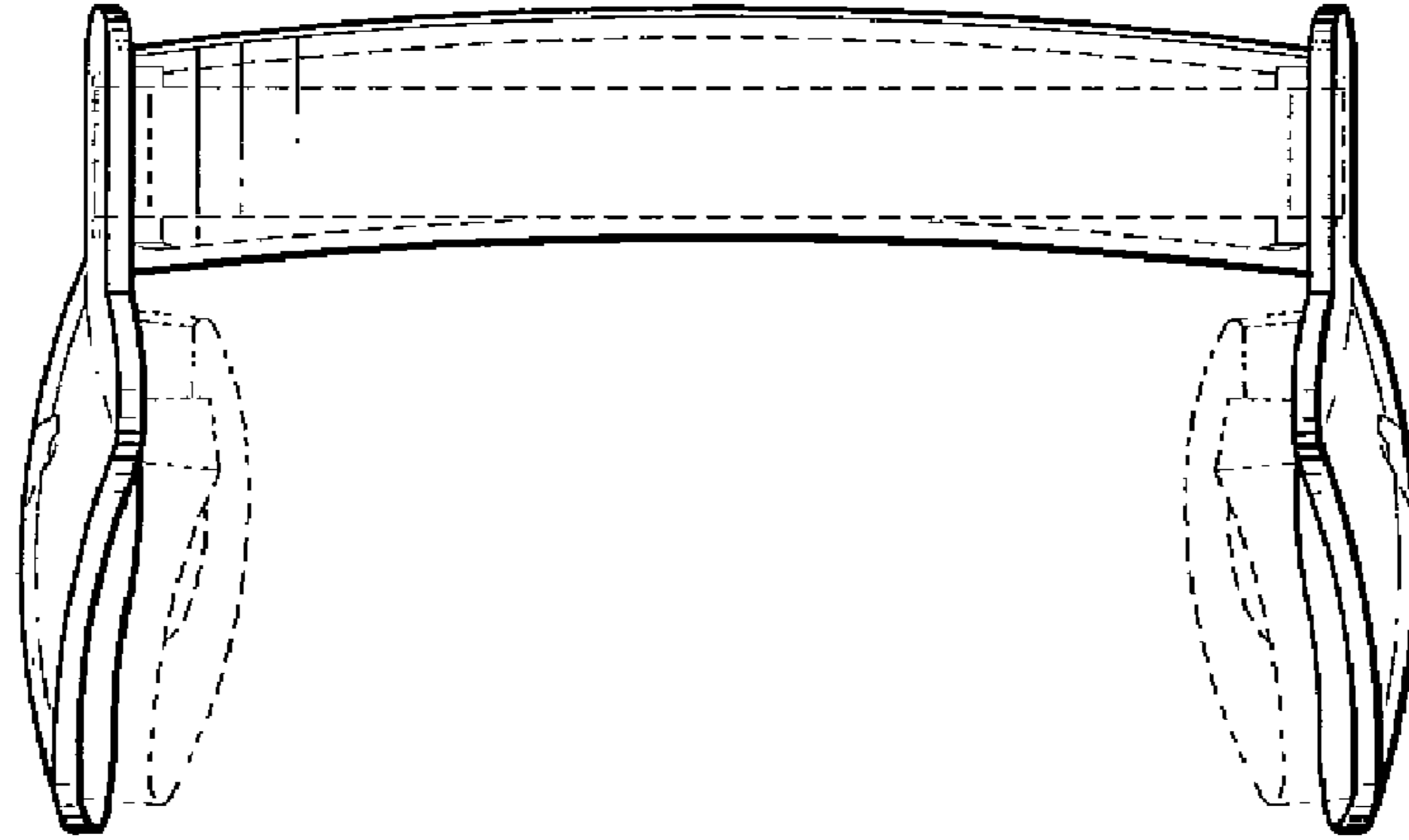
*FIG. -7-*



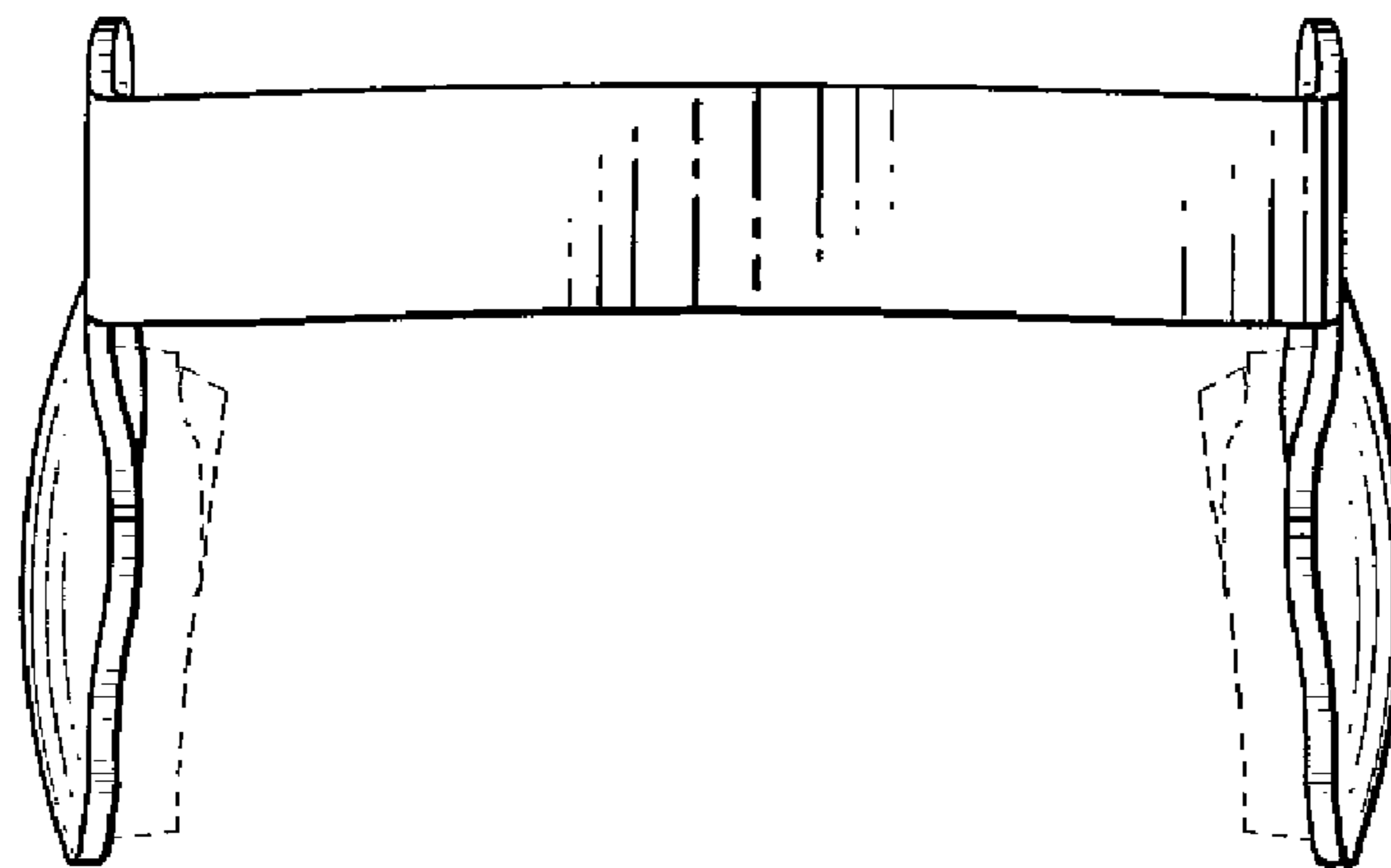
*FIG. -8-*



*FIG. -9-*

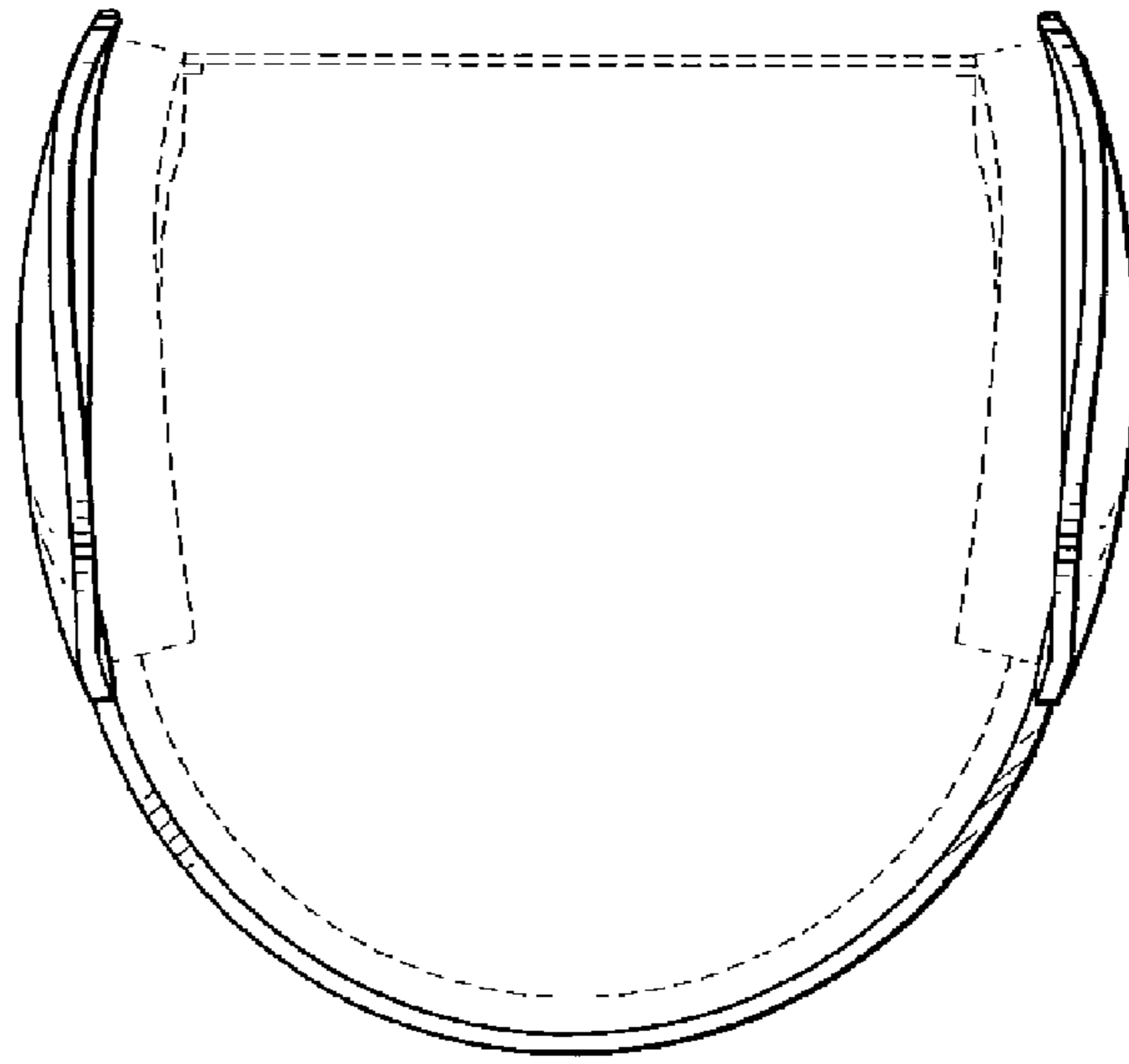


*FIG. -10-*

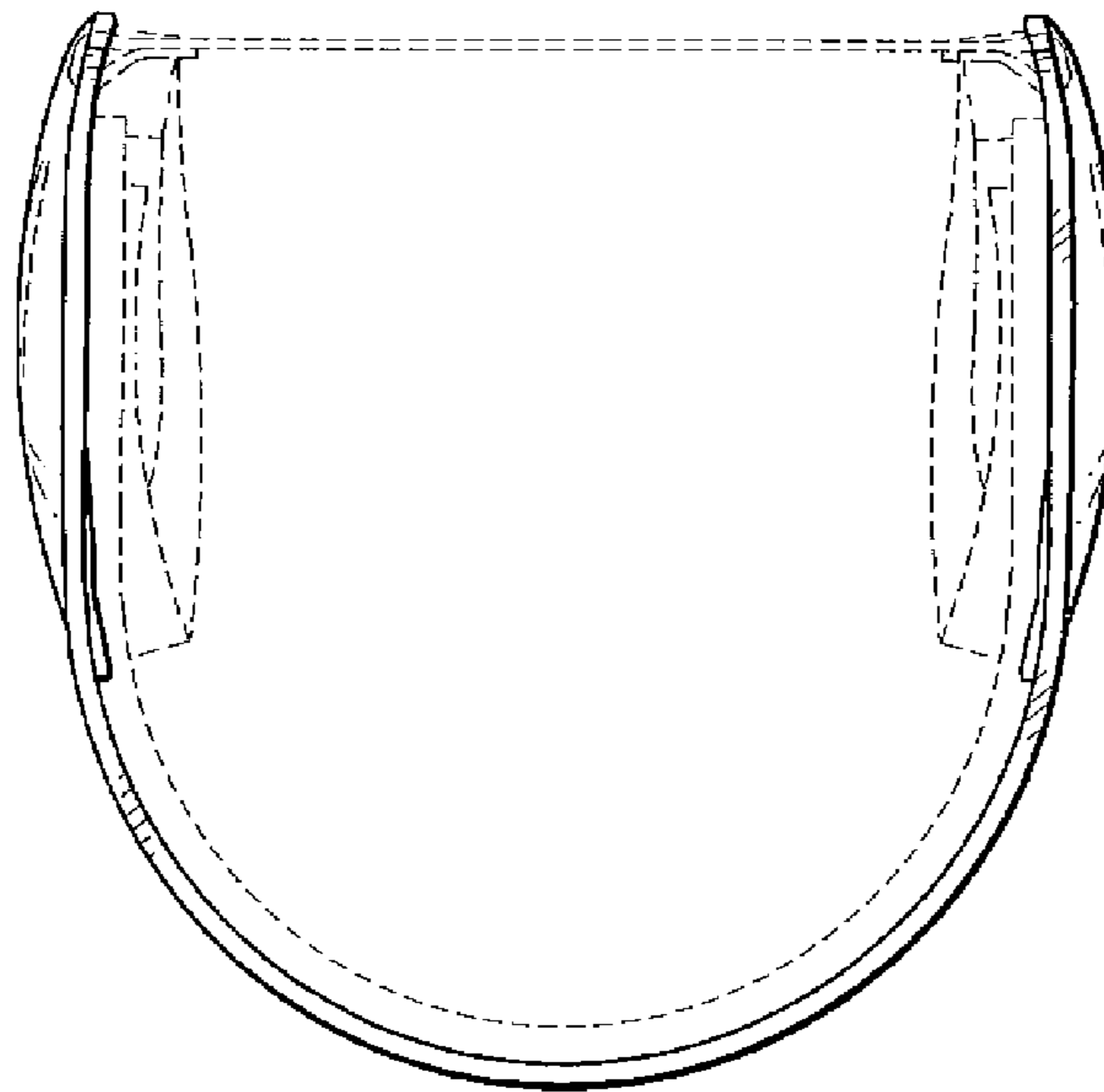


*FIG. -11-*

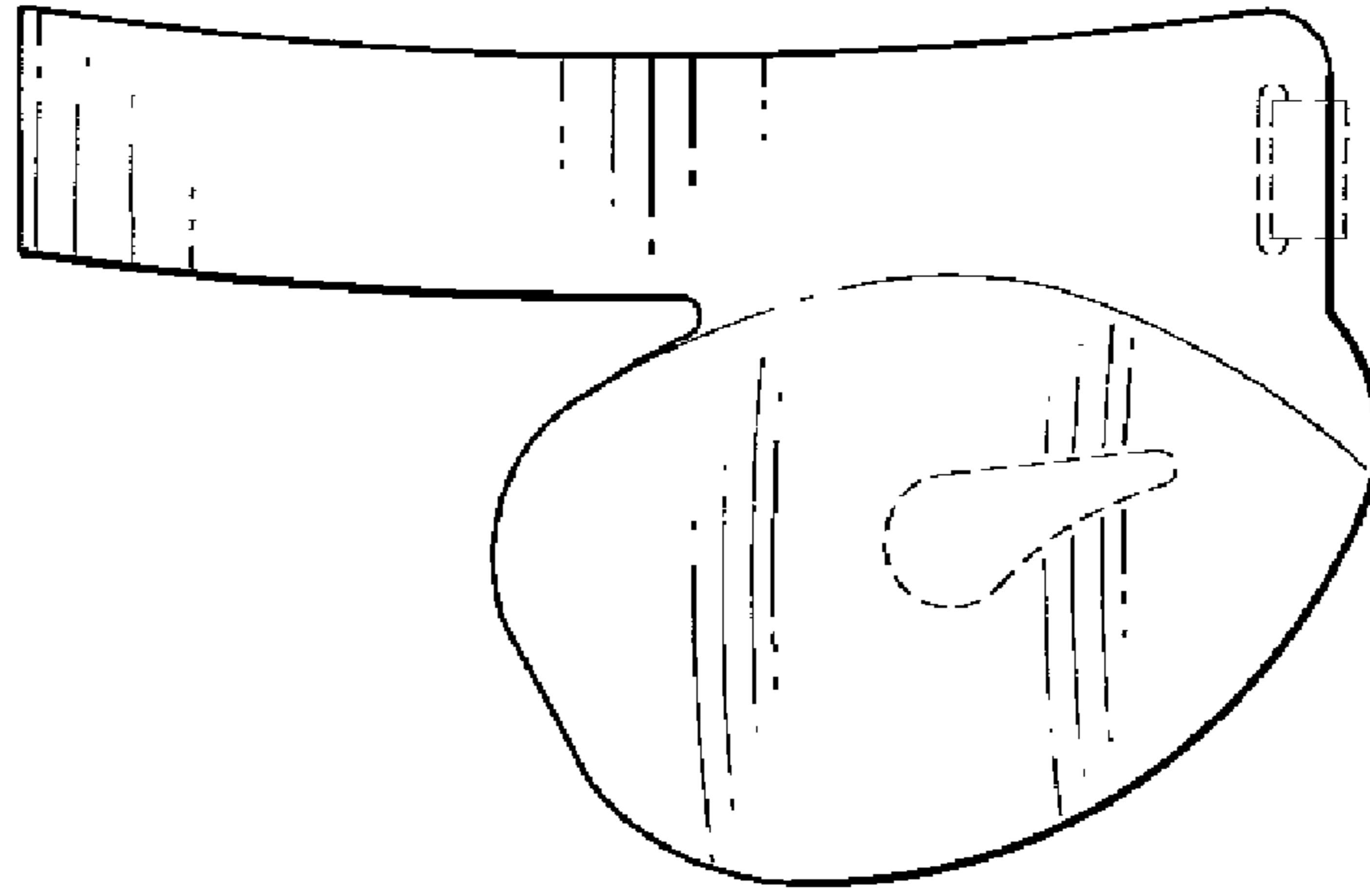




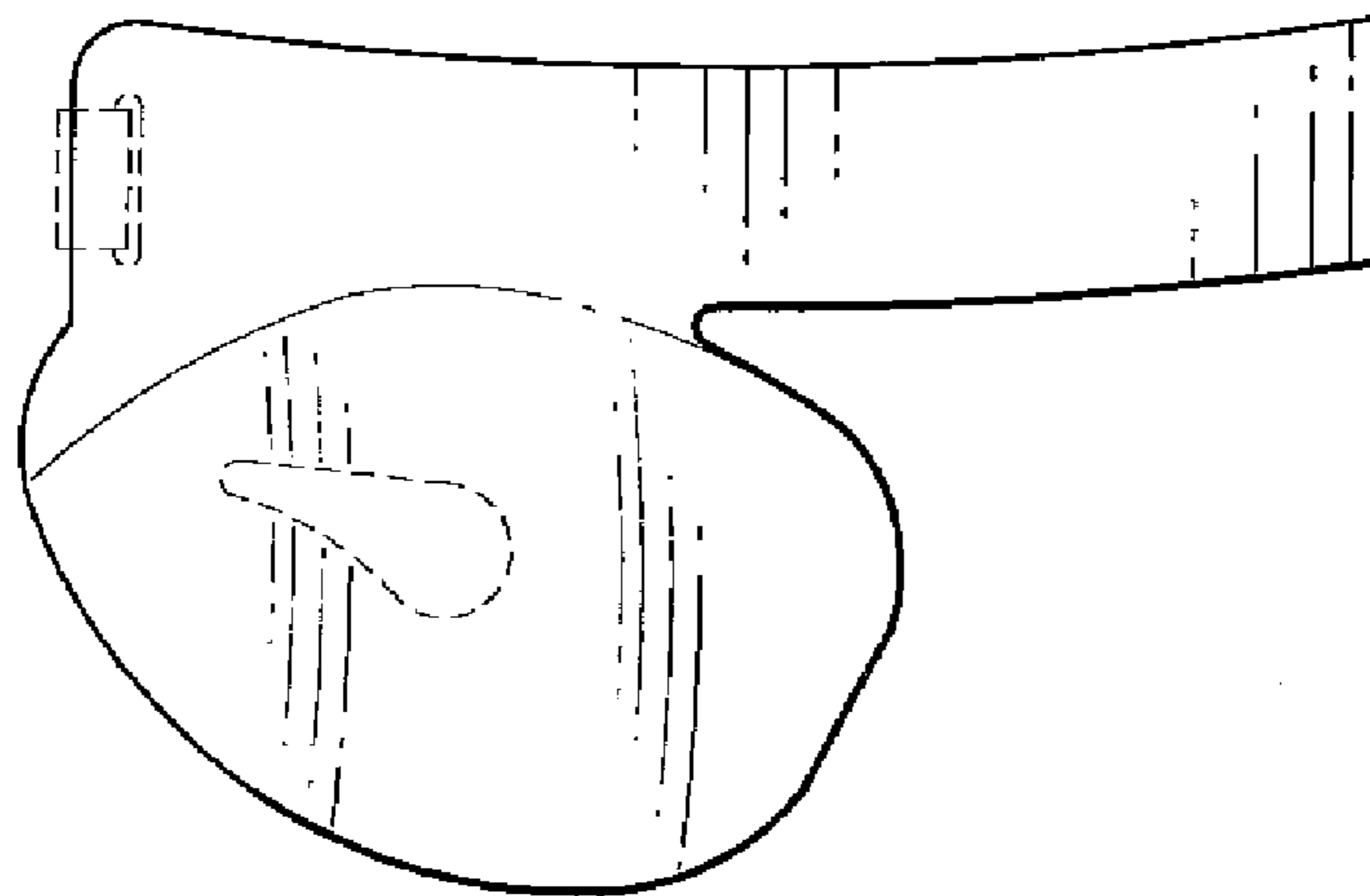
*FIG. -12-*



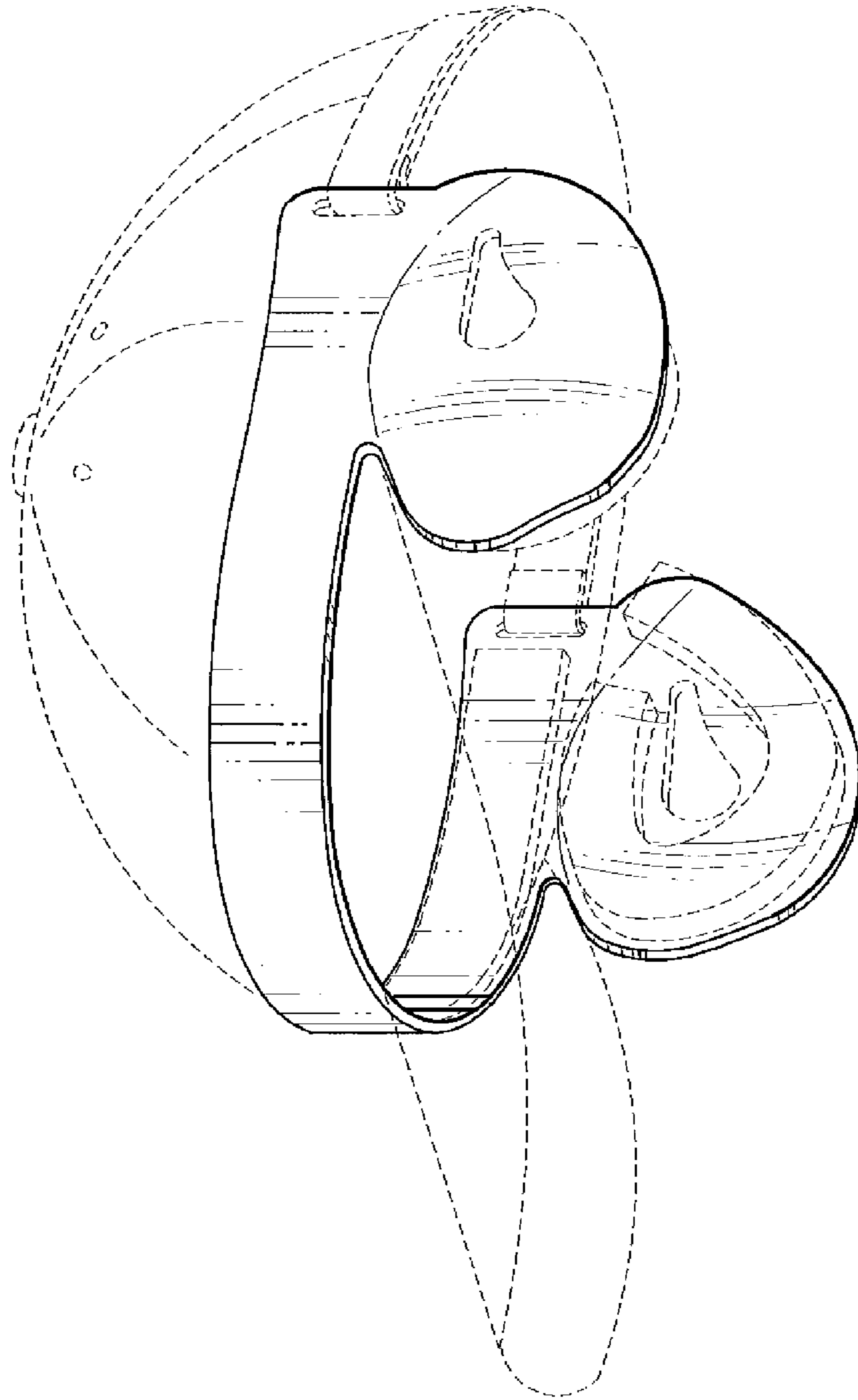
*FIG. -13-*



*FIG. -14-*



*FIG. -15-*



*FIG. -16-*