



US00D643494S

(12) **United States Design Patent**
Book

(10) **Patent No.:** **US D643,494 S**

(45) **Date of Patent:** **** Aug. 16, 2011**

(54) **GOLF TOOL ACCESSORY DEVICE**

(76) Inventor: **Jack Book**, Joliet, IL (US)

(**) Term: **14 Years**

(21) Appl. No.: **29/348,102**

(22) Filed: **Nov. 30, 2009**

(51) **LOC (9) Cl.** **21-02**

(52) **U.S. Cl.** **D21/793**

(58) **Field of Classification Search** D21/789,
D21/793-796; 473/406, 408, 285-286; 206/315.1;
224/679, 245, 249, 666, 670, 683, 918, 932;
D3/215, 254, 221

See application file for complete search history.

(56) **References Cited**

U.S. PATENT DOCUMENTS

D270,747	S *	9/1983	Eisinger et al.	D21/793
4,736,877	A *	4/1988	Clark	206/315.1
5,419,551	A *	5/1995	Hoyt et al.	473/406
D394,692	S *	5/1998	Edwards	D21/793
5,782,708	A *	7/1998	Kimball, Jr.	473/408
5,799,853	A *	9/1998	Brewster	224/679
6,220,973	B1 *	4/2001	Hsu	473/408
6,491,594	B1 *	12/2002	Dacosta	473/408

* cited by examiner

Primary Examiner — Mitchell I Siegel

(74) *Attorney, Agent, or Firm* — Basil E. Demeur; Alan B. Samlan; David J. Hurley

(57) **CLAIM**

I claim the ornamental design for a golf tool accessory device, as shown and described.

DESCRIPTION

FIG. 1 is a front perspective view of the golf tool accessory device;

FIG. 2 is a rear perspective view of the golf tool accessory device;

FIG. 3 is a top view of the golf tool accessory device;

FIG. 4 is a side elevational view of the golf tool accessory device;

FIG. 5 is a front elevational view of the golf tool accessory device;

FIG. 6 is a side elevational view of the opposed side of the golf tool accessory device;

FIG. 7 is a bottom view of the golf tool accessory device;

FIG. 8 is a rear elevational view of the golf tool accessory device;

FIG. 9 is a front perspective view of the golf tool accessory device with the divot tool removed, and the ball spot slug removed in an exploded view; and,

FIG. 10 is a rear exploded perspective view of the golf tool accessory device.

The broken line showing on the device and the backside of the golf tool is included for the purpose of illustrating and forms no part of the claimed design.

1 Claim, 2 Drawing Sheets

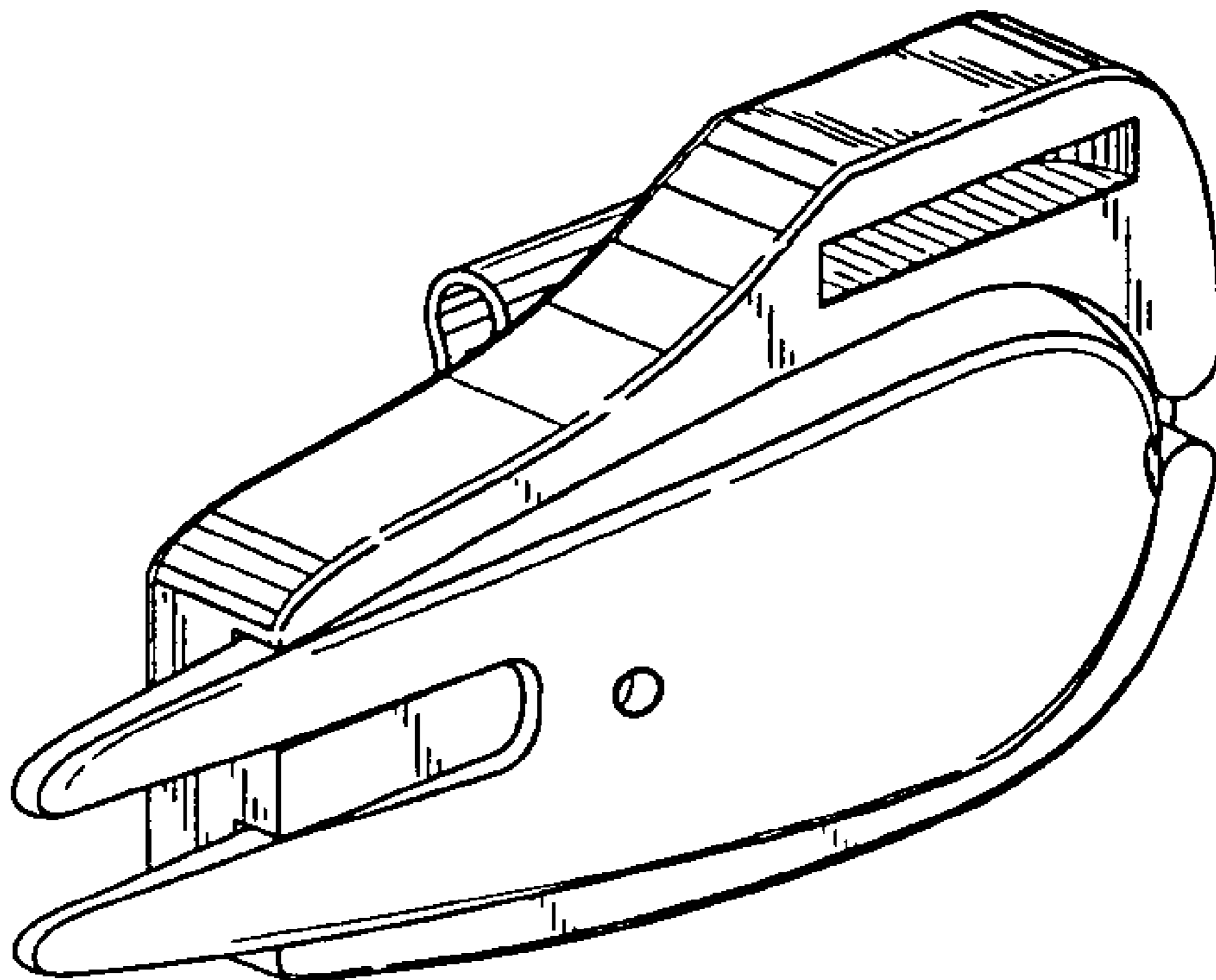

Fig. 1

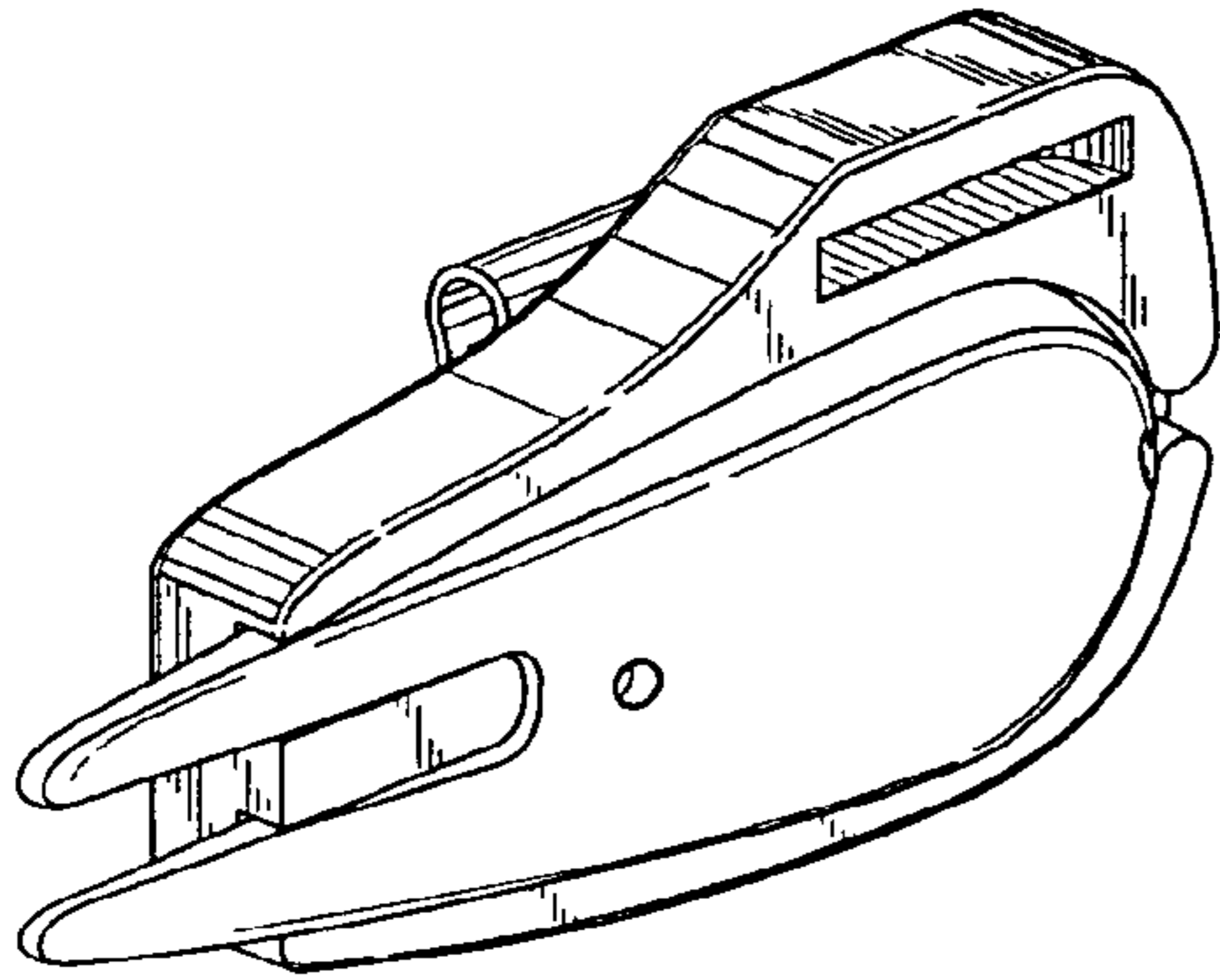

Fig. 2

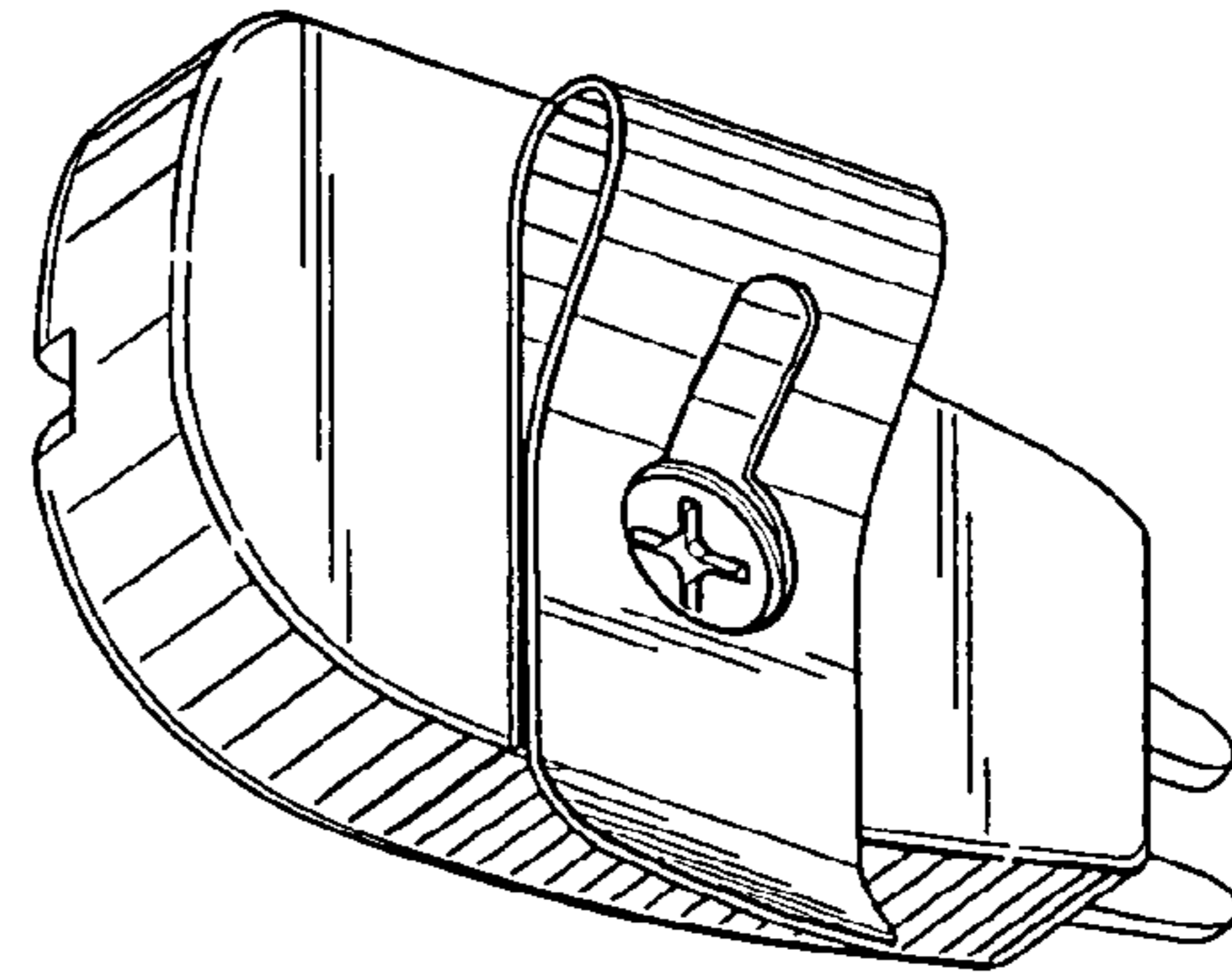

Fig. 3

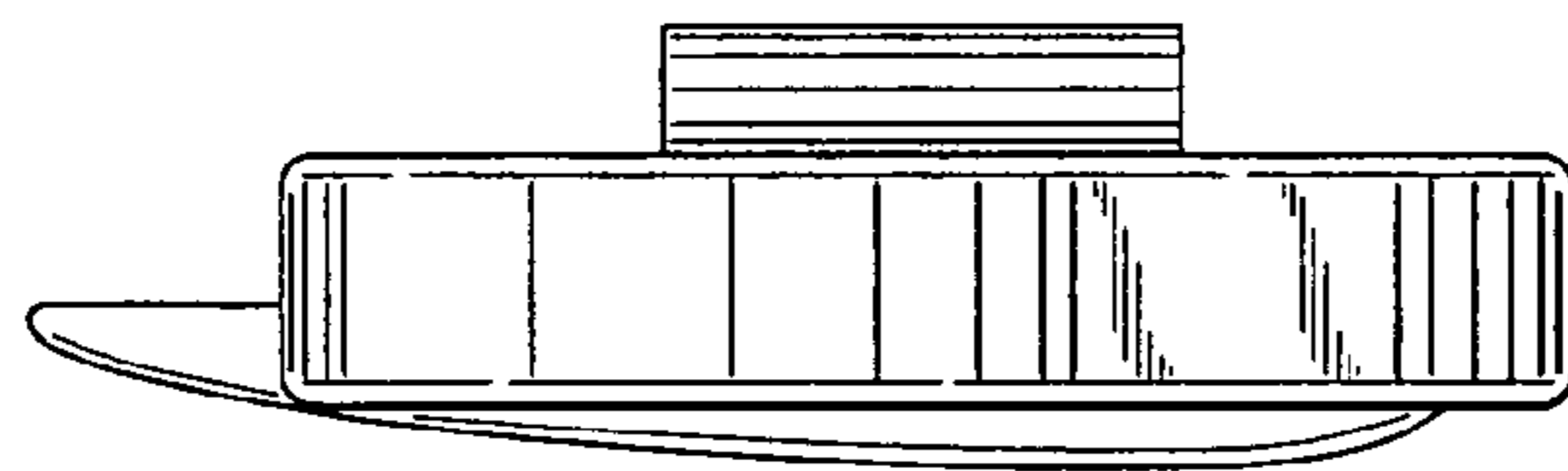

Fig. 4

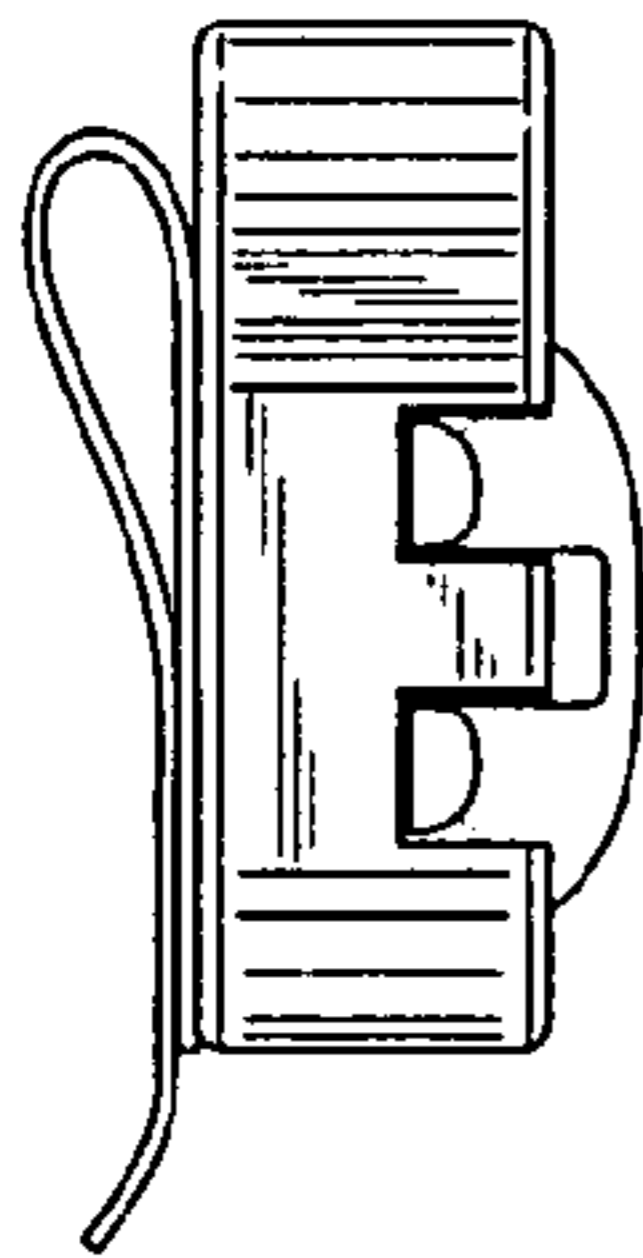

Fig. 5

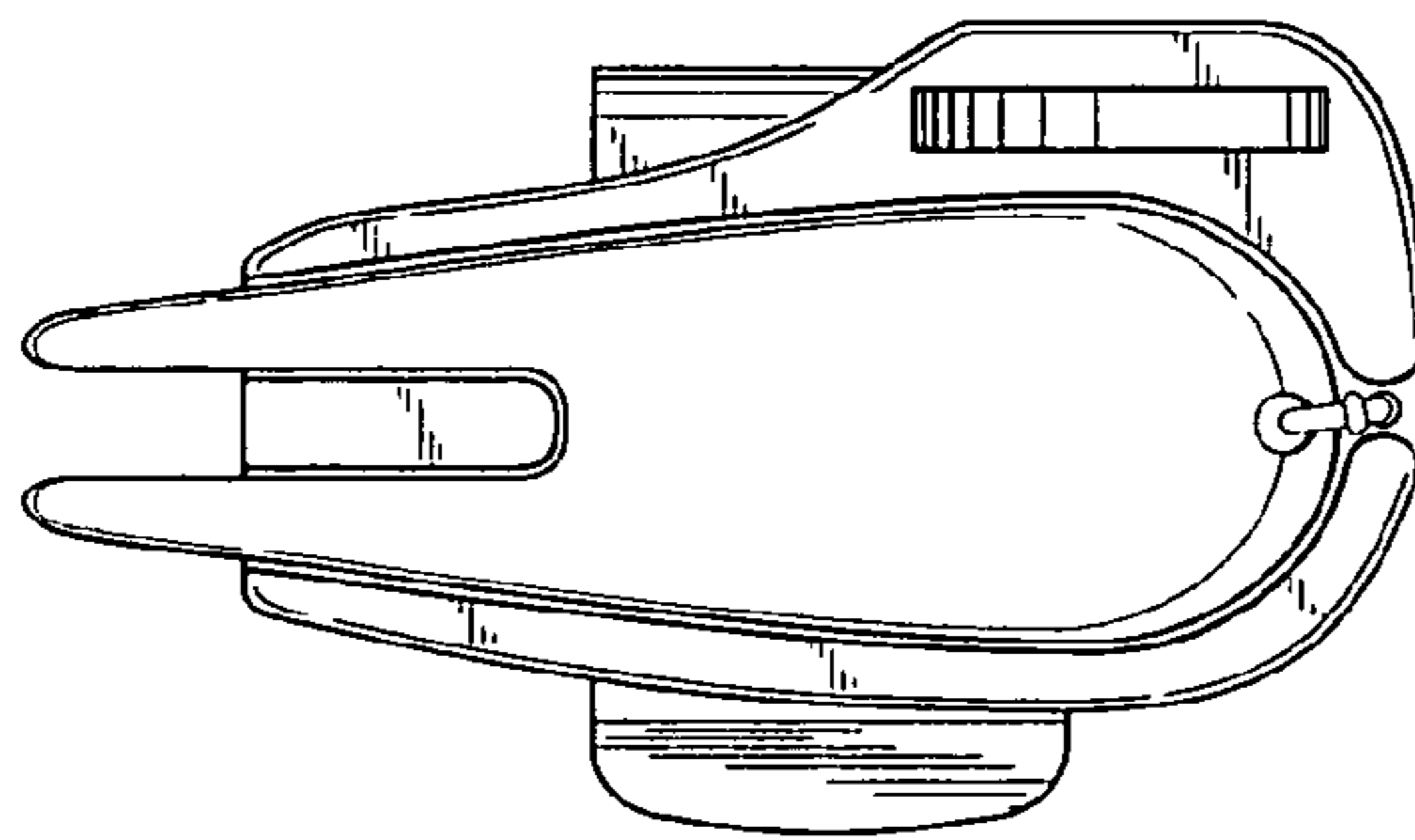

Fig. 6

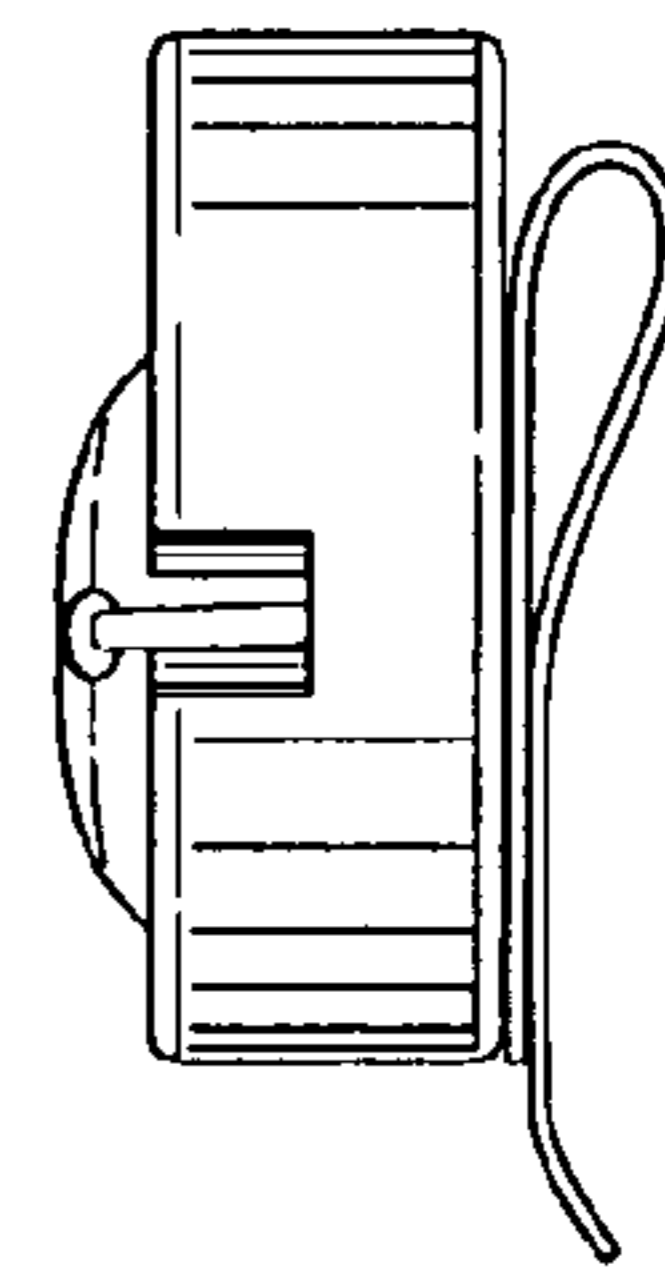

Fig. 7

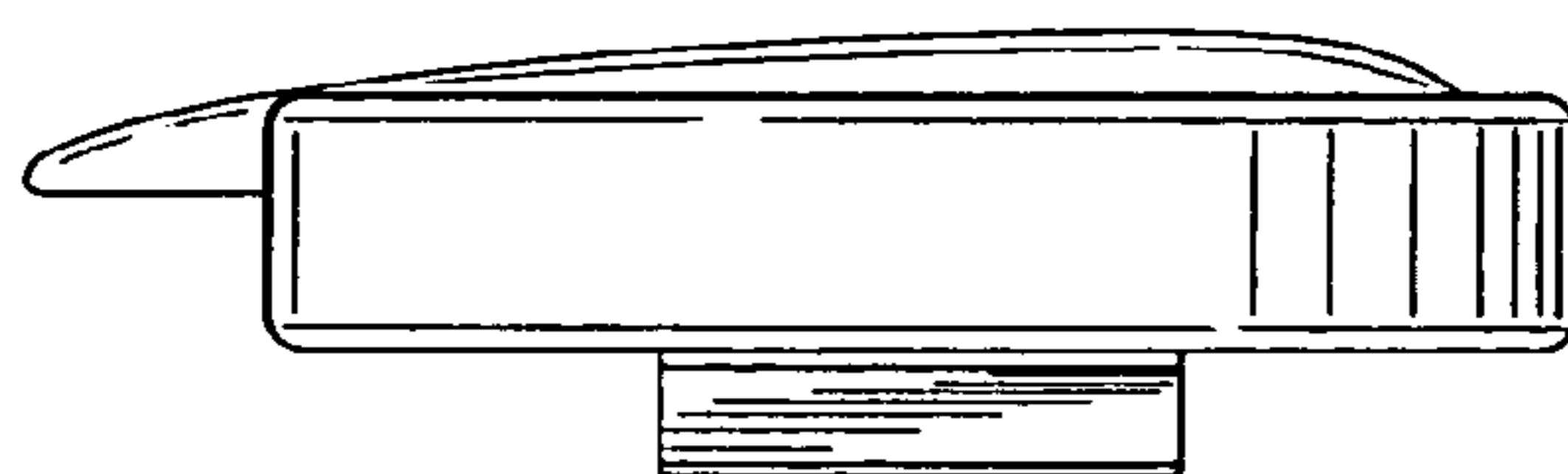

Fig. 8

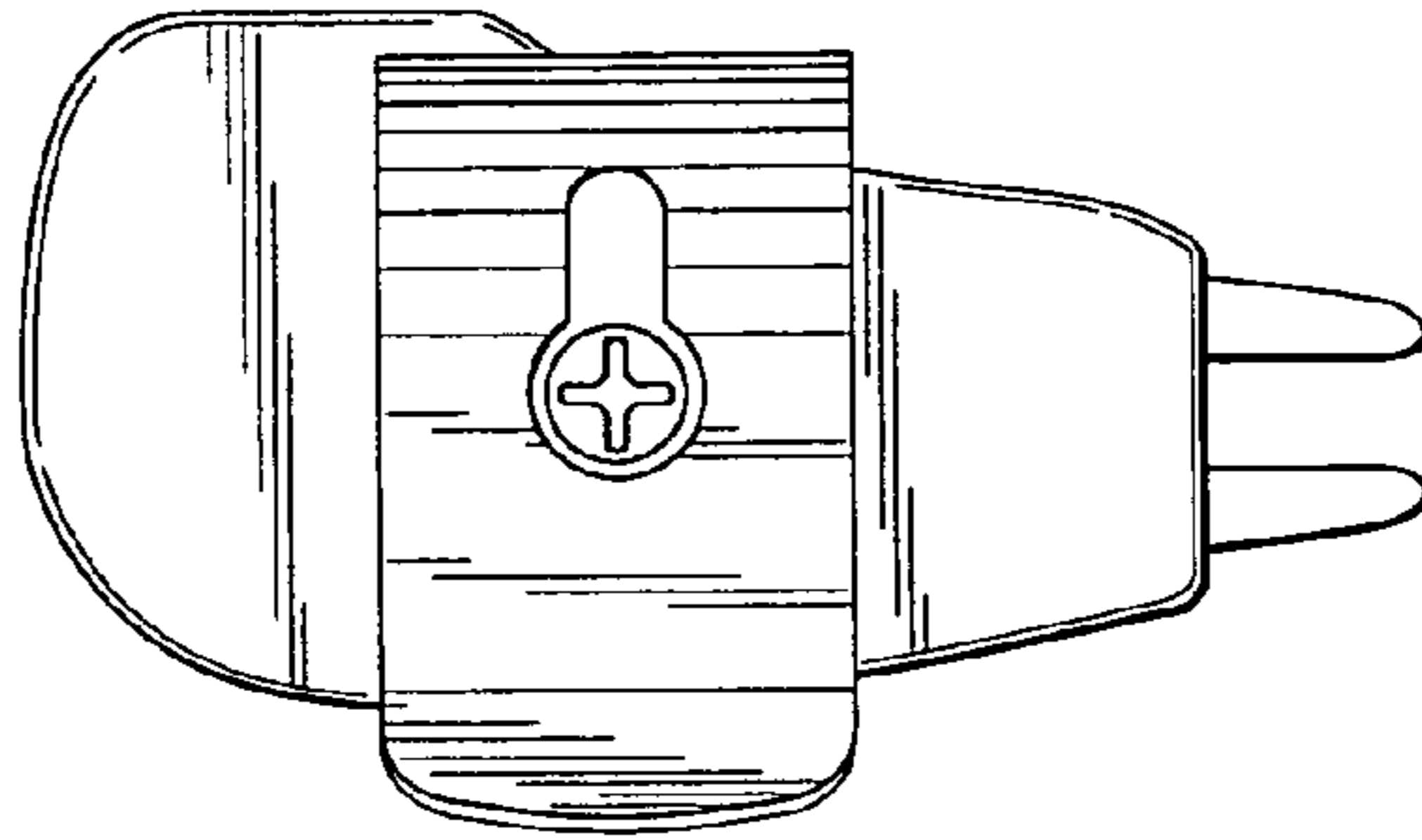

Fig. 9

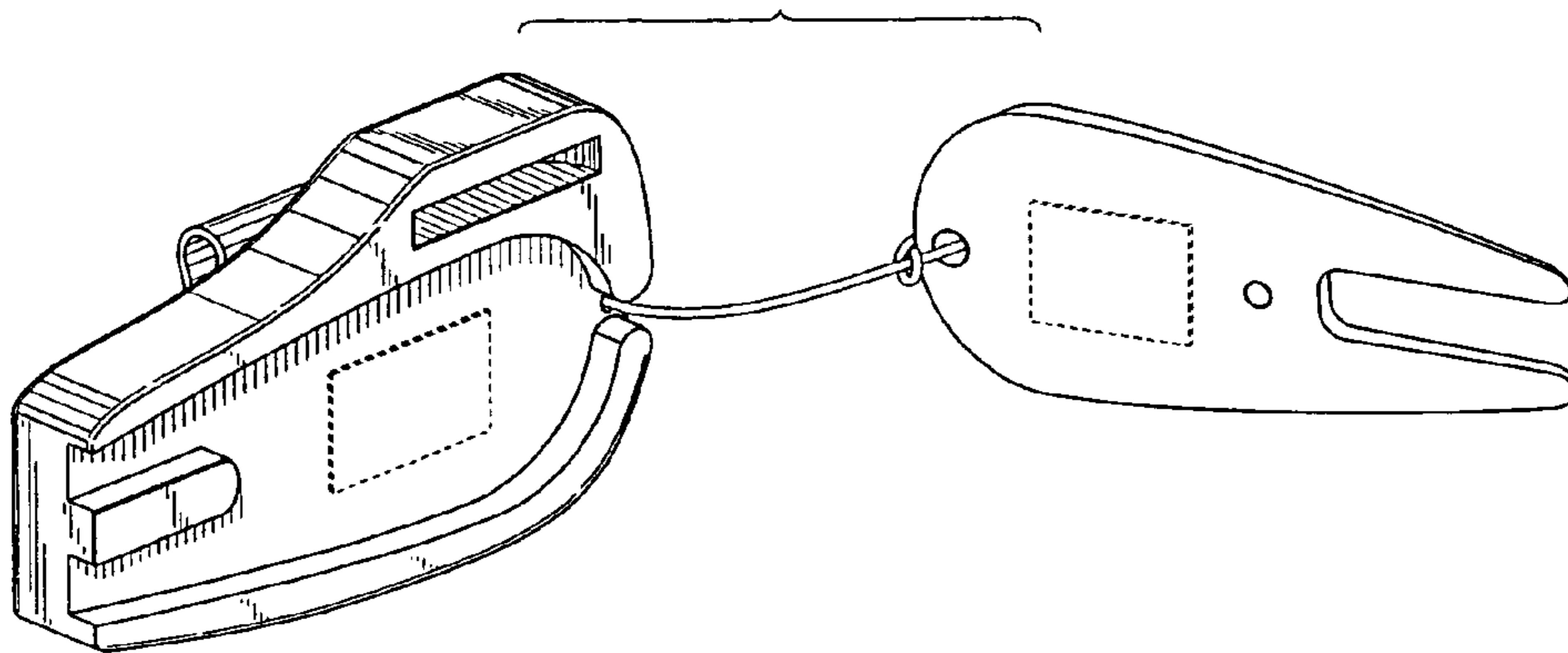

Fig. 10

