



US00D643473S

(12) **United States Design Patent**
Collins

(10) **Patent No.:** **US D643,473 S**

(45) **Date of Patent:** **** Aug. 16, 2011**

(54) **GLOW IN THE DARK HORSESHOE GAME**

(76) Inventor: **Patrick Collins**, McPherson, KS (US)

(**) Term: **14 Years**

(21) Appl. No.: **29/368,547**

(22) Filed: **Aug. 25, 2010**

(51) **LOC (9) Cl.** **21-01**

(52) **U.S. Cl.** **D21/304**

(58) **Field of Classification Search** D21/300,
D21/304, 302, 324, 333; 273/317, 331, 336,
273/338, 348, 398, 402, 407, 127 R, 148 R,
273/459; 473/415, 516, 569, 588, 590, 591
See application file for complete search history.

D330,393 S	10/1992	Grant et al.	
D341,382 S *	11/1993	Deming et al.	D21/304
5,317,489 A	5/1994	Delli Gatti et al.	
5,358,256 A *	10/1994	Kraemer	273/401
5,971,396 A *	10/1999	Wieland	273/317.1
D478,357 S *	8/2003	Penna	D21/304
7,789,394 B2 *	9/2010	Lendvay	273/331
7,802,795 B2 *	9/2010	Bos	273/336

* cited by examiner

Primary Examiner — Prabhakar Deshmukh

(74) *Attorney, Agent, or Firm* — Dale J. Ream

(57) **CLAIM**

The ornamental design for a glow in the dark horseshoe game, as shown and described.

DESCRIPTION

FIG. 1 is a front view of a glow in the dark horseshoe game showing my new design;

FIG. 2 is a back view thereof;

FIG. 3 is a right side view thereof;

FIG. 4 is a left side view thereof;

FIG. 5 is a top view thereof; and,

FIG. 6 is a bottom view thereof.

(56) **References Cited**

U.S. PATENT DOCUMENTS

3,467,384 A *	9/1969	Brandon et al.	273/337
3,773,330 A *	11/1973	Glass et al.	273/337
3,825,261 A *	7/1974	Zapos	473/477
4,880,242 A *	11/1989	White	273/336
D306,706 S *	3/1990	Hansel	D10/114
4,927,159 A *	5/1990	Morrissey et al.	273/338
4,936,590 A	6/1990	Palmer	
D328,765 S *	8/1992	Strom, Jr.	D21/304

1 Claim, 4 Drawing Sheets

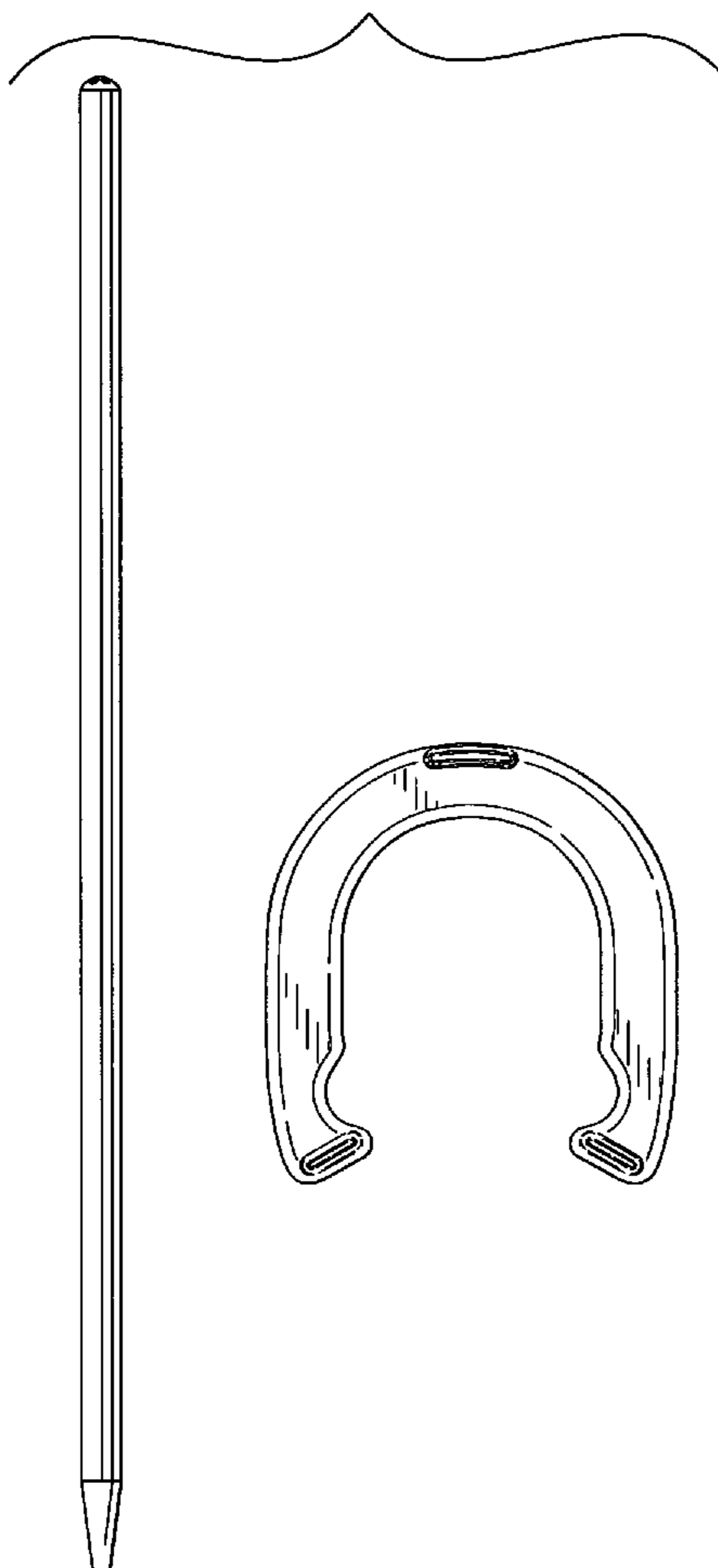

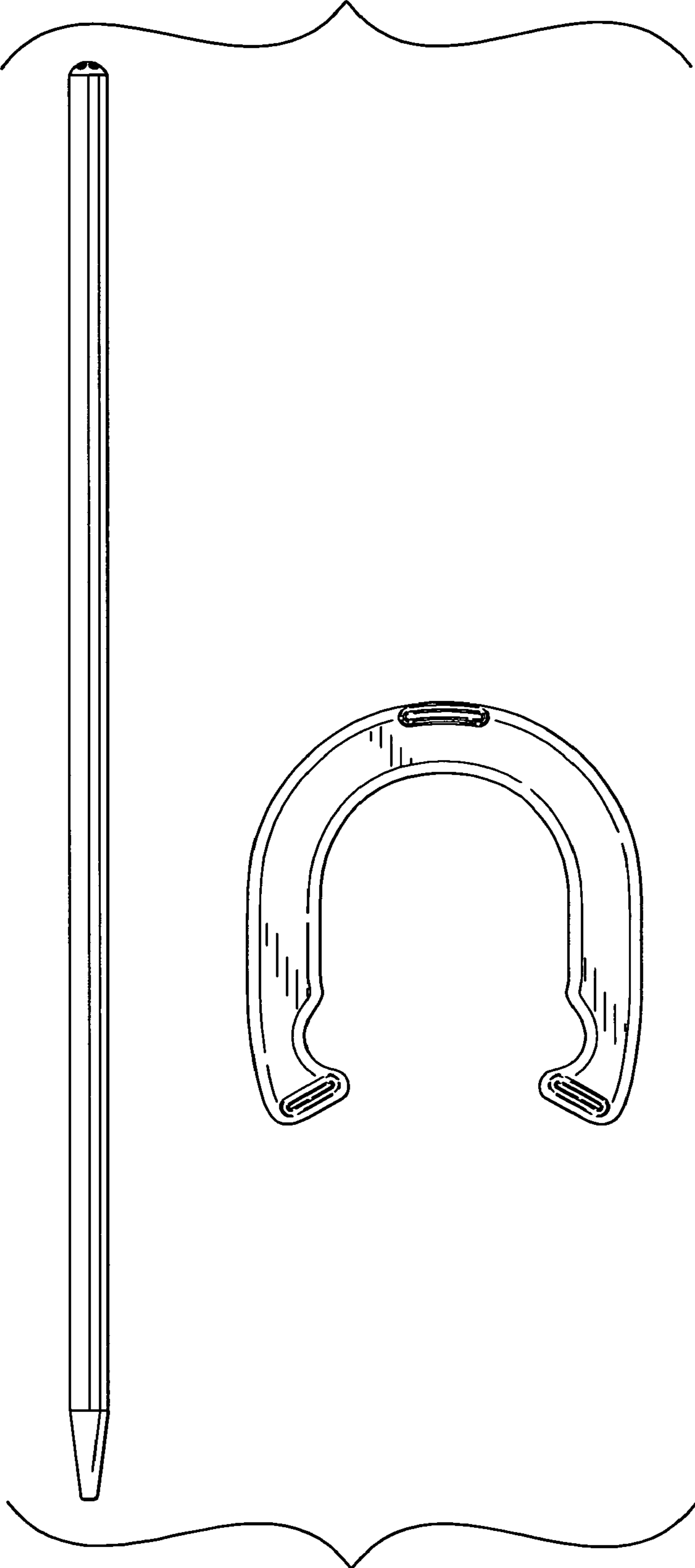

Fig. 1

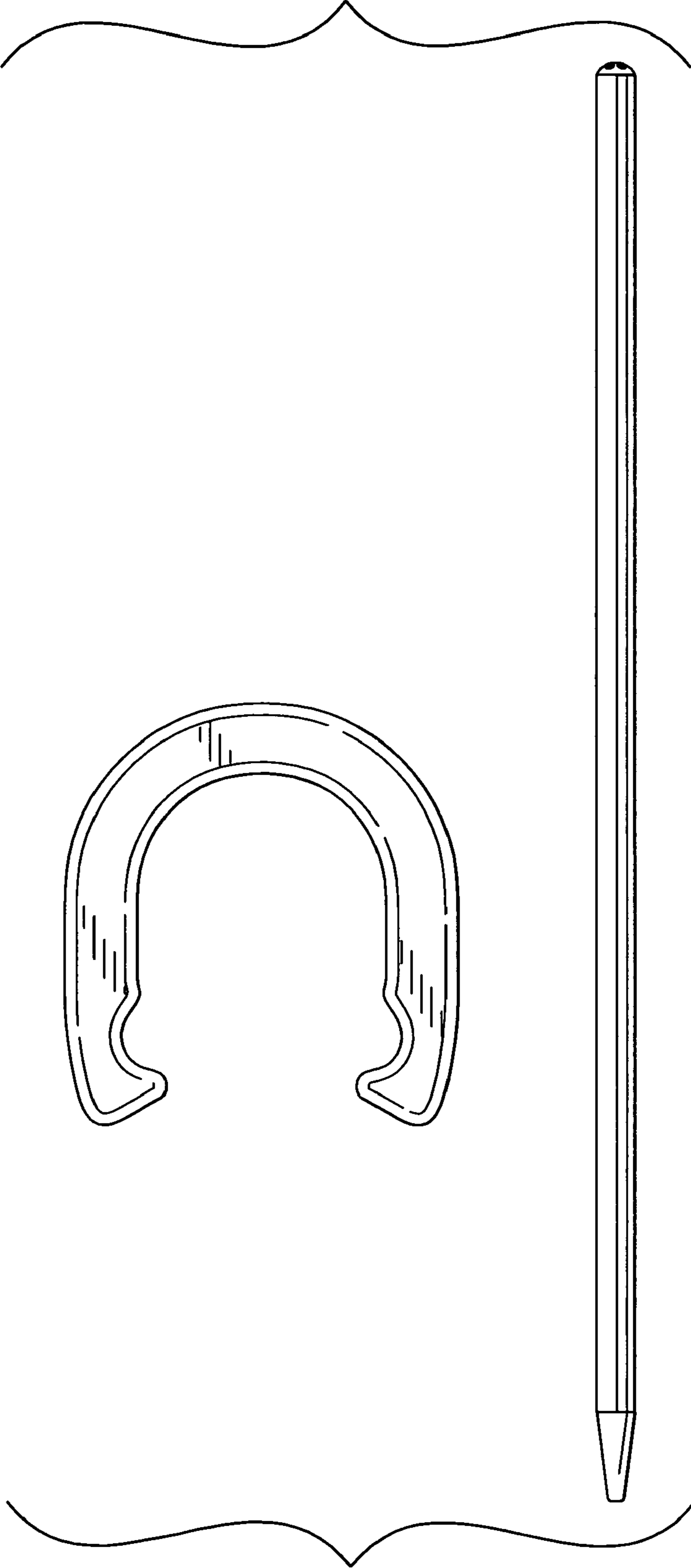

Fig. 2

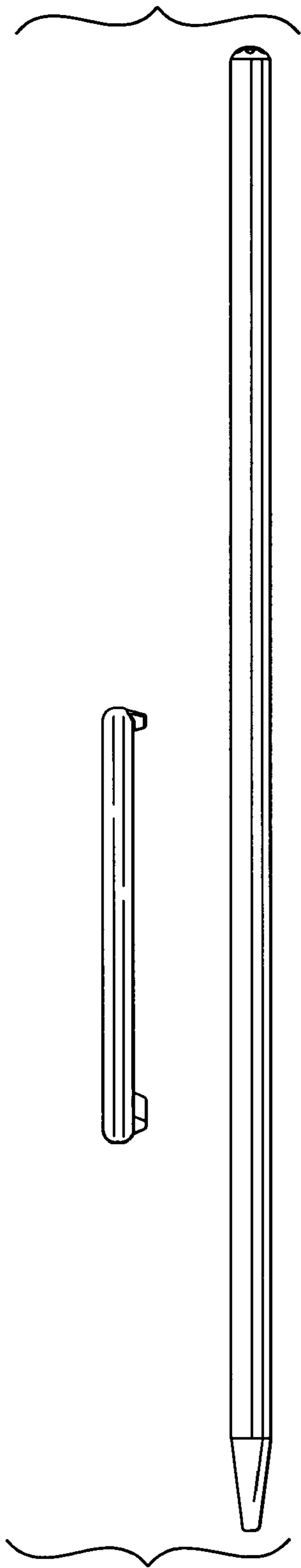

Fig. 3

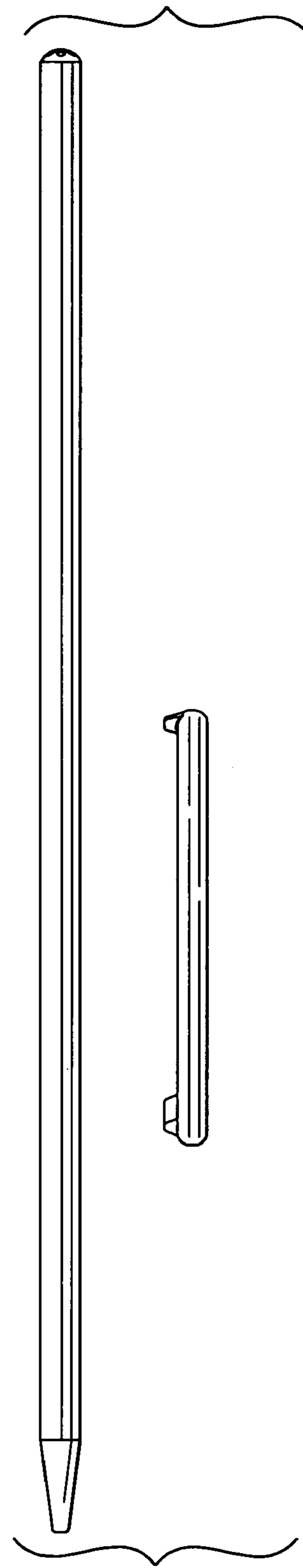

Fig. 4

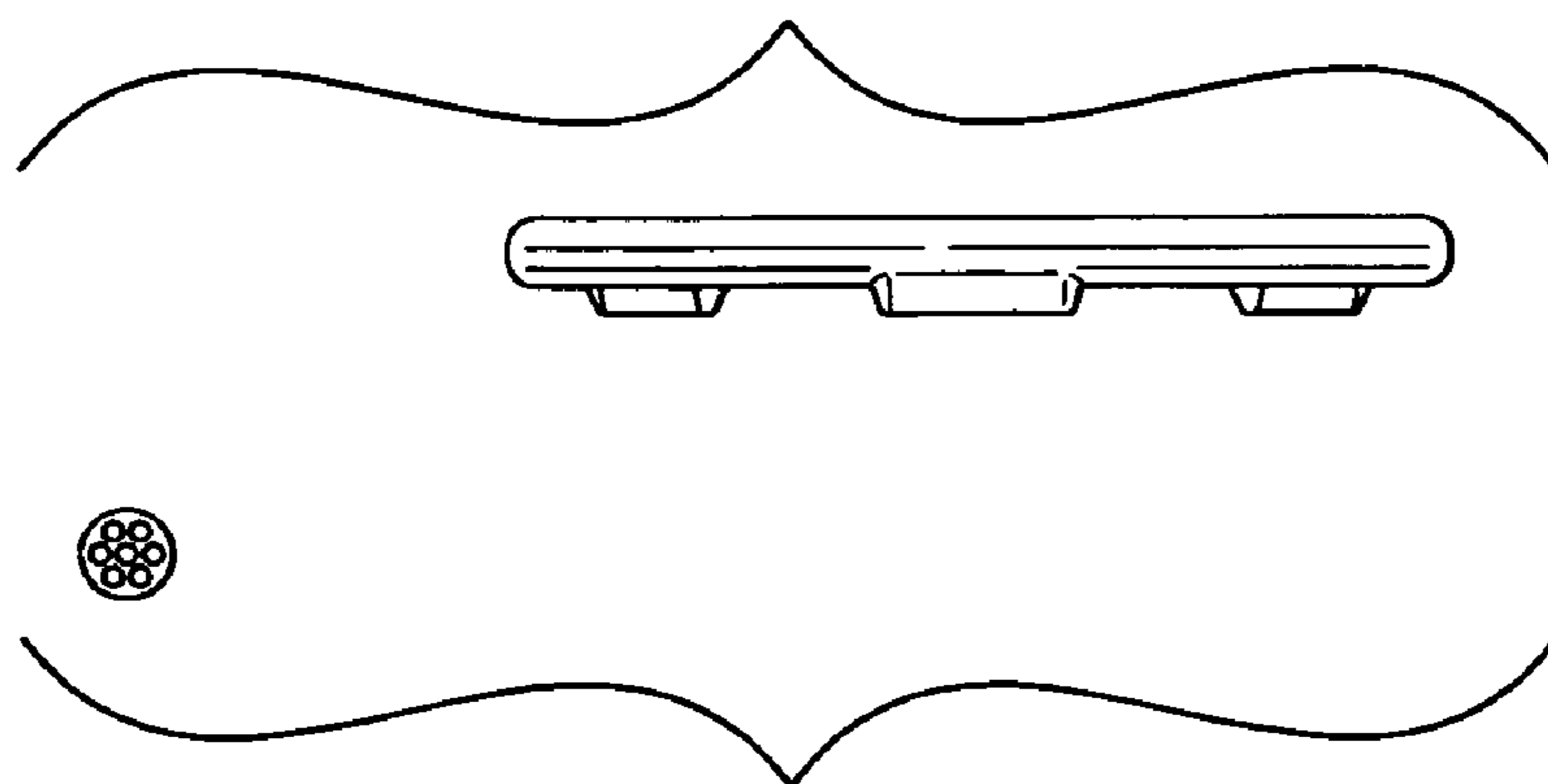

Fig. 5

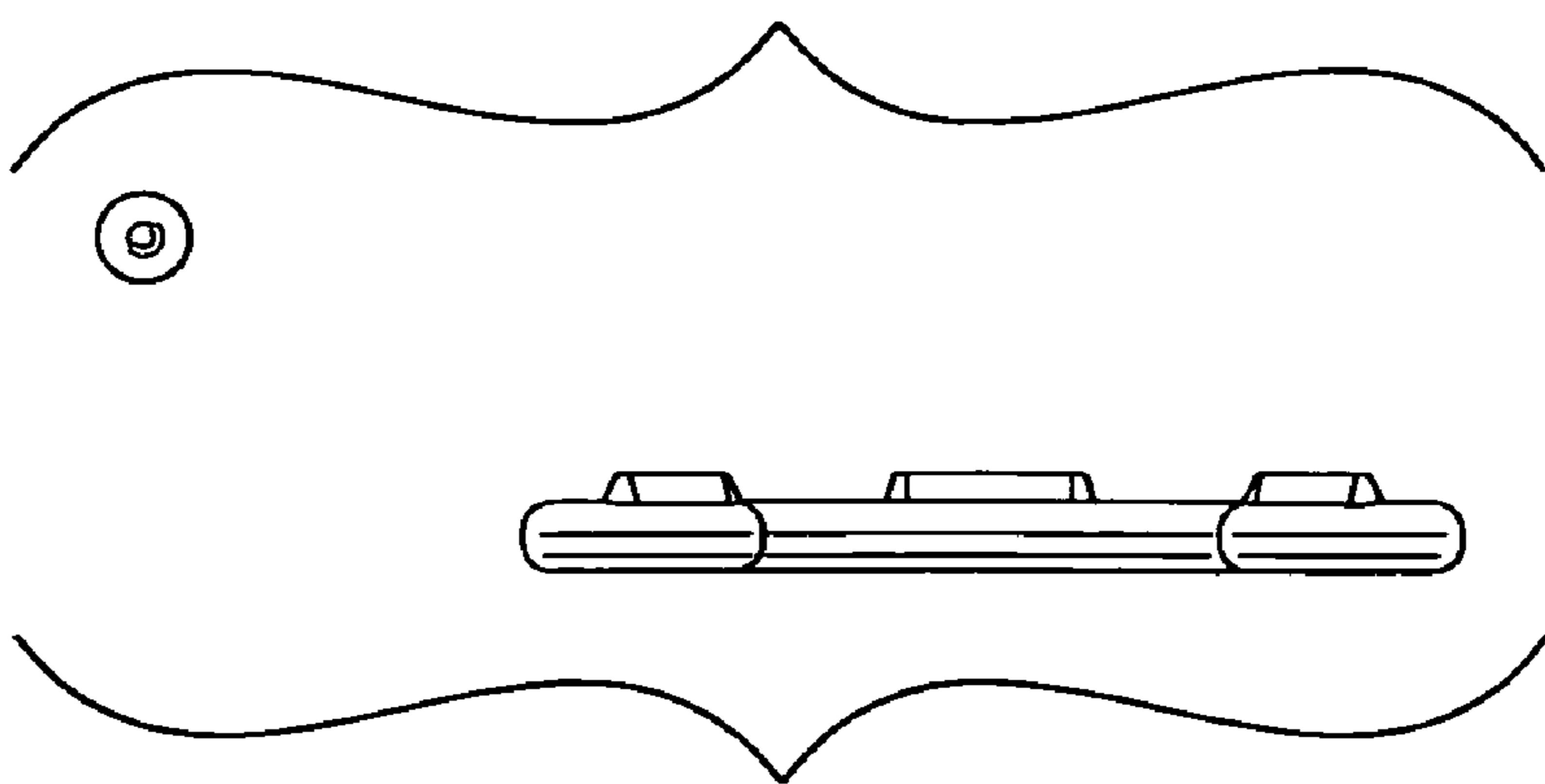

Fig. 6