



US00D643431S

(12) **United States Design Patent**
Nakamura

(10) **Patent No.:** **US D643,431 S**

(45) **Date of Patent:** **** Aug. 16, 2011**

(54) **MEMORY CARD**

(75) **Inventor:** **Yutaka Nakamura, Kyoto (JP)**

(73) **Assignee:** **Panasonic Corporation, Osaka (JP)**

(**) **Term:** **14 Years**

(21) **Appl. No.:** **29/379,105**

(22) **Filed:** **Nov. 15, 2010**

(30) **Foreign Application Priority Data**

May 17, 2010 (JP) 2010-012039
May 17, 2010 (JP) 2010-012040

(51) **LOC (9) Cl.** **14-02**

(52) **U.S. Cl.** **D14/436**

(58) **Field of Classification Search** D14/435-438,
D14/478-480; 235/441, 443, 487, 492, 493,
235/495; 361/737, 679, 752, 736, 728, 796,
361/797, 729, 730, 725-727; 257/678, 679,
257/693, E23.064; 439/946, 948, 159; 174/250,
174/260, 52.1, 52.2; 710/300-303; 438/121
See application file for complete search history.

(56) **References Cited**

U.S. PATENT DOCUMENTS

6,097,605	A *	8/2000	Klatt et al.	361/737
D444,473	S *	7/2001	Okamoto et al.	D14/436
D445,111	S *	7/2001	Okamoto et al.	D14/436
D446,525	S *	8/2001	Okamoto et al.	D14/436
D452,243	S *	12/2001	Wallace	D14/436
6,381,143	B1 *	4/2002	Nakamura	361/737
D457,887	S *	5/2002	Kadonaga	D14/436
D458,935	S *	6/2002	Hiroki	D14/436
6,490,667	B1 *	12/2002	Ikeda	711/163
D488,477	S *	4/2004	Yu et al.	D14/436
6,729,892	B2 *	5/2004	Takada et al.	439/159
D491,951	S *	6/2004	Yu et al.	D14/436
D492,686	S *	7/2004	Yu et al.	D14/436
D492,687	S *	7/2004	Yu et al.	D14/436

D494,180	S *	8/2004	Taniguchi	D14/436
6,808,424	B2 *	10/2004	Kaneshiro et al.	439/638
6,816,386	B2 *	11/2004	Oguchi et al.	361/769
6,834,810	B2 *	12/2004	Maruyama	235/492
6,851,959	B2 *	2/2005	Ooya et al.	439/159
D504,433	S *	4/2005	Nishizawa et al.	D14/436
6,910,635	B1 *	6/2005	Miks et al.	235/487
6,932,654	B2 *	8/2005	Washino	439/630
D510,935	S *	10/2005	Yamada et al.	D14/436
6,979,227	B2 *	12/2005	Ikeda	439/630
D515,586	S *	2/2006	Cuellar et al.	D14/436
D515,587	S *	2/2006	Cuellar et al.	D14/436
D518,059	S *	3/2006	Cuellar et al.	D14/436
D518,483	S *	4/2006	Yu et al.	D14/436
7,032,827	B2 *	4/2006	Wang et al.	235/492
7,059,871	B1 *	6/2006	Hsiao	439/76.1

(Continued)

FOREIGN PATENT DOCUMENTS

JP S-923537 4/1995

(Continued)

Primary Examiner — Susan Moon Lee

(74) *Attorney, Agent, or Firm* — Brinks Hofer Gilson & Lione

(57) **CLAIM**

I claim the ornamental design for a memory card, as shown and described.

DESCRIPTION

FIG. 1 is a front perspective view of a first embodiment of a memory card of the present invention; FIG. 2 is a rear perspective view thereof; FIG. 3 is a front view thereof; FIG. 4 is a rear view thereof; FIG. 5 is a first side view thereof; FIG. 6 is a second side view thereof; FIG. 7 is a top view thereof; and, FIG. 8 is a bottom view thereof.

1 Claim, 6 Drawing Sheets

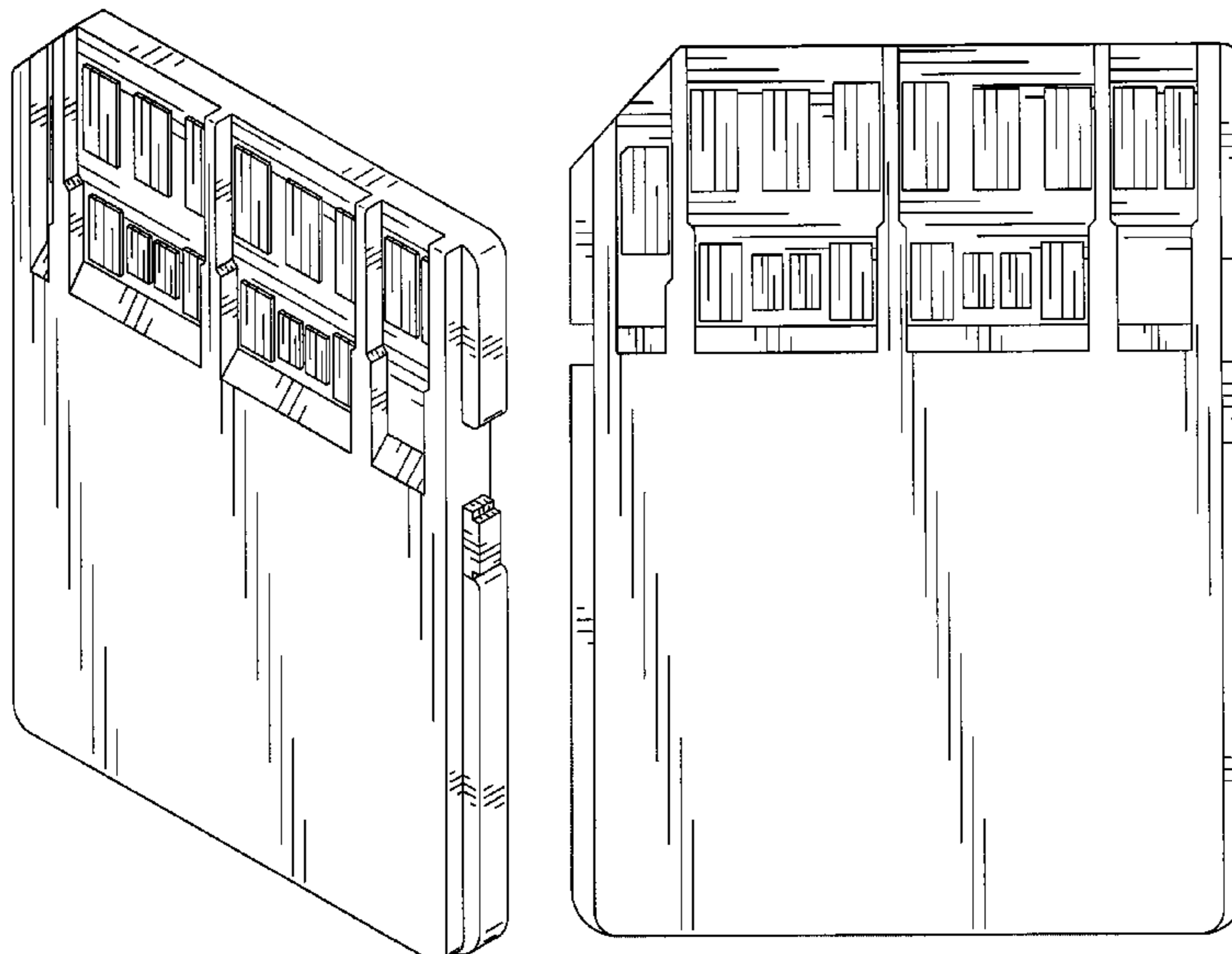

FIG. 1

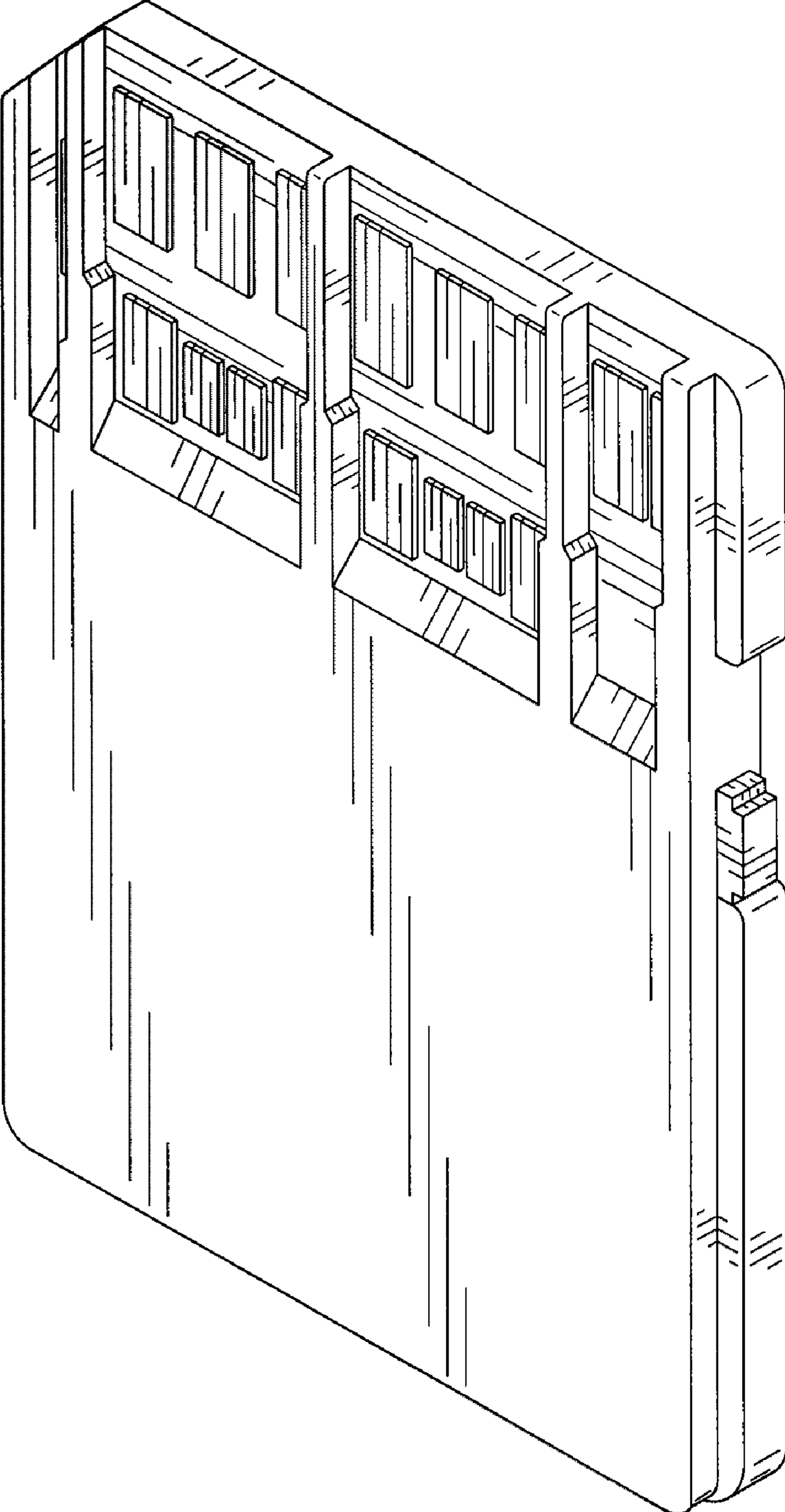

FIG. 2

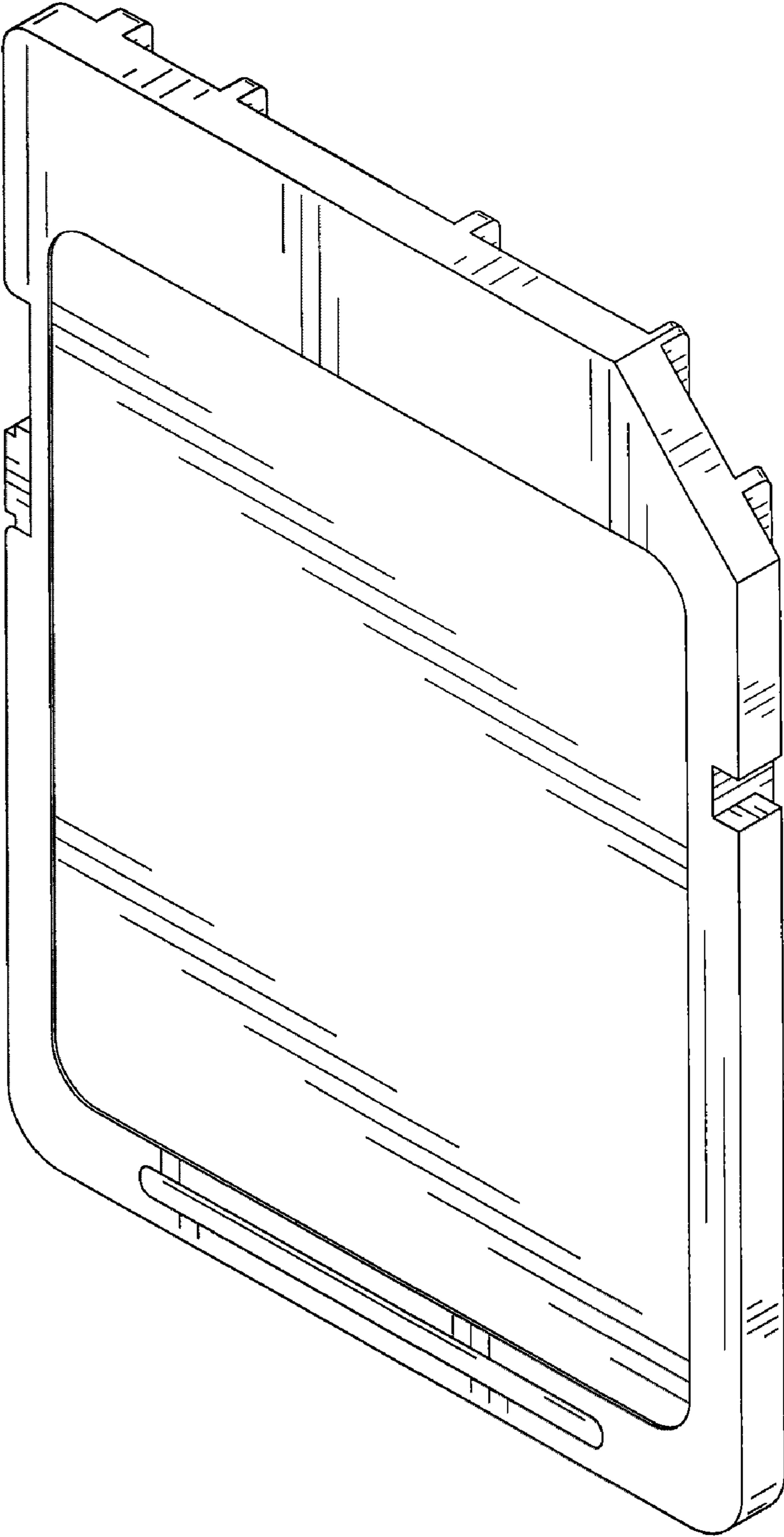

FIG. 3

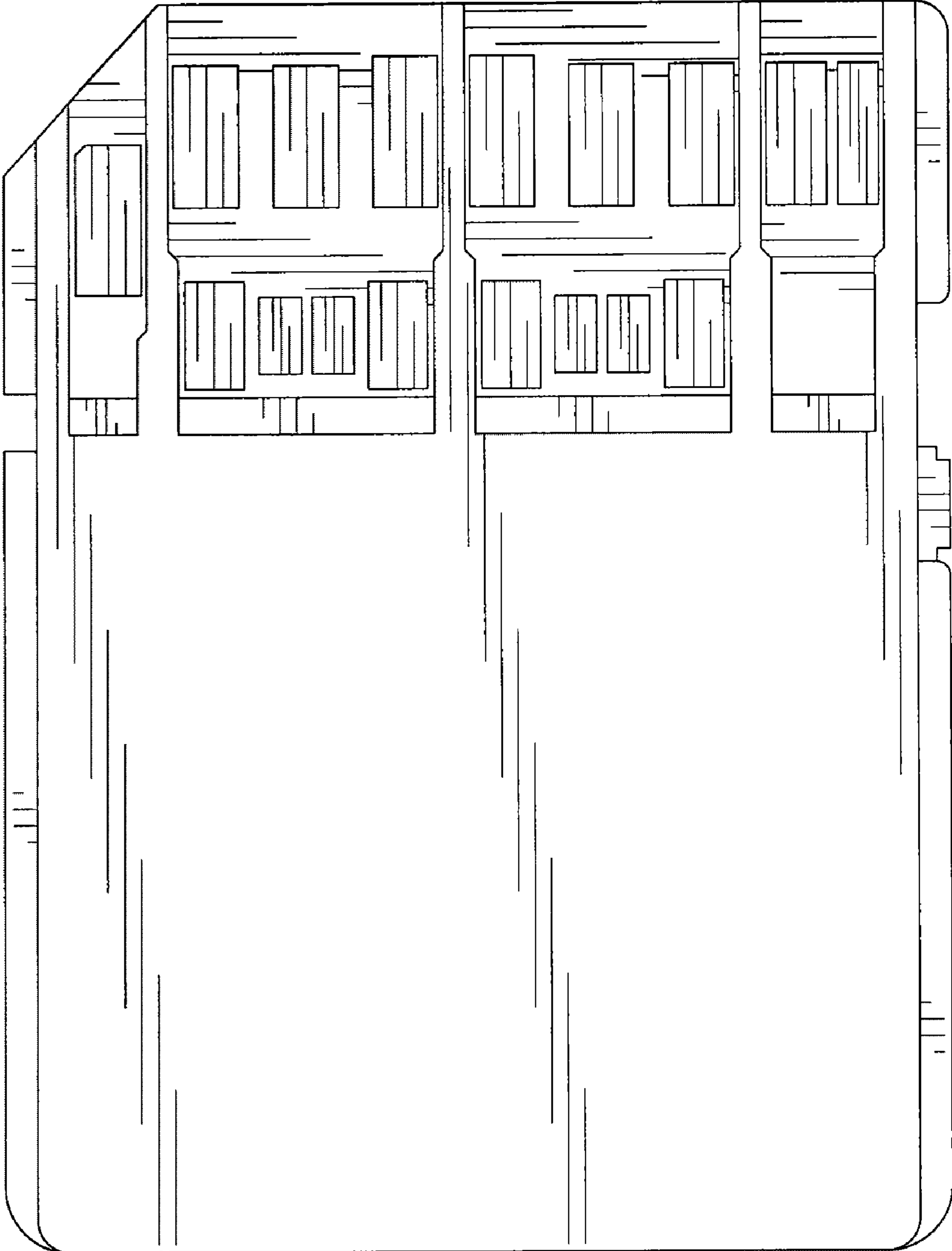

FIG. 4

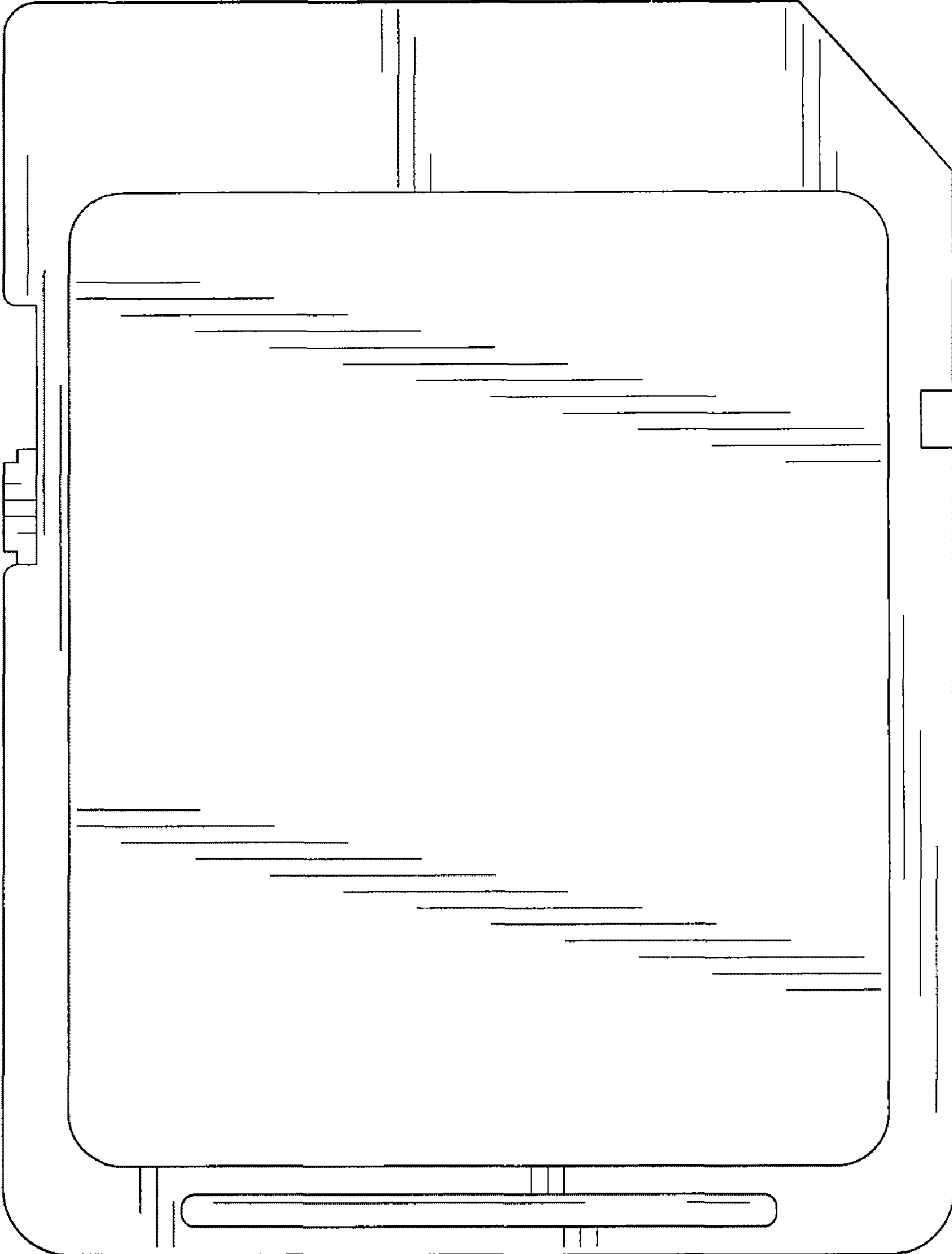

FIG. 5

FIG. 6

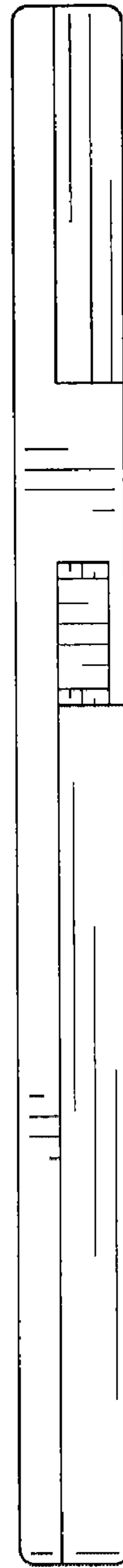
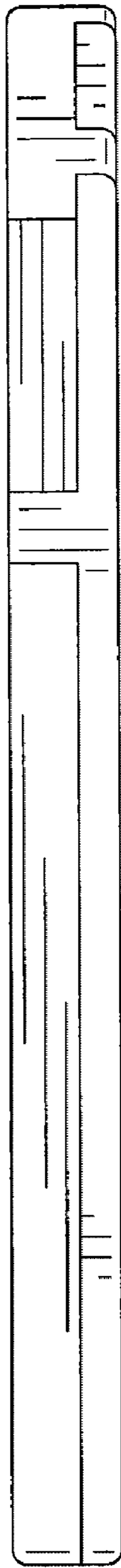

FIG. 7

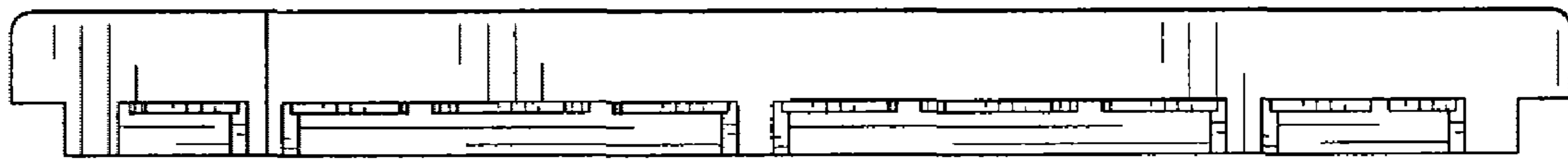

FIG. 8

