



US00D643426S

(12) **United States Design Patent**  
**A. B.**

(10) **Patent No.:** **US D643,426 S**  
(45) **Date of Patent:** **\*\* Aug. 16, 2011**

(54) **LAPTOP COMPUTER**

(75) Inventor: **Arun A. B.**, Kerala (IN)

(73) Assignee: **MerchSource, LLC**, Foothill Ranch, CA (US)

(\*\*) Term: **14 Years**

(21) Appl. No.: **29/368,393**

(22) Filed: **Aug. 23, 2010**

(51) **LOC (9) Cl.** ..... **14-02**

(52) **U.S. Cl.** ..... **D14/316**

(58) **Field of Classification Search** ..... D14/315-331;  
D18/1, 2, 7, 11; D19/59, 60; 200/5 A, 5 R,  
200/6 A, 6 R; 345/102, 168, 173; 235/145 A,  
235/145 R; 400/484-489; 361/679.06, 679.09,  
361/679.26, 679.27

See application file for complete search history.

(56) **References Cited**

**U.S. PATENT DOCUMENTS**

D487,891	S *	3/2004	Yang et al.	.....	D14/316
D499,725	S *	12/2004	Lee	.....	D14/316
6,847,520	B2 *	1/2005	Hashimoto	.....	361/679.01
6,870,740	B2 *	3/2005	Hsu et al.	.....	361/732
D521,992	S *	5/2006	Morooka et al.	.....	D14/316
D551,223	S *	9/2007	Luminosu et al.	.....	D14/320
D584,301	S *	1/2009	Soetejo et al.	.....	D14/327
D606,535	S *	12/2009	Morooka et al.	.....	D14/316
2004/0083577	A1 *	5/2004	Lu et al.	.....	16/367

\* cited by examiner

*Primary Examiner* — Freda S Nunn

(74) *Attorney, Agent, or Firm* — The Eclipse Group LLP

(57) **CLAIM**

I claim the ornamental design for a laptop computer, as shown and described.

**DESCRIPTION**

FIG. 1 is a left, front perspective view of a laptop computer. FIG. 2 is a right, rear perspective view of the laptop computer illustrated in FIG. 1.

FIG. 3 is a top plan view of the laptop computer illustrated in FIG. 1.

FIG. 4 is a front elevation of the laptop computer illustrated in FIG. 1.

FIG. 5 is a rear elevation view of the laptop computer illustrated in FIG. 1.

FIG. 6 is a bottom plan view of the laptop computer illustrated in FIG. 1.

FIG. 7 is a right elevation view of the laptop computer illustrated in FIG. 1.

FIG. 8 is a left elevation view of the laptop computer illustrated in FIG. 1.

FIG. 9 is a right, front perspective view of the laptop computer illustrated in FIG. 1 showing the laptop computer cover in the open position.

FIG. 10 is a right, rear perspective view of the laptop computer illustrated in FIG. 1 showing the laptop computer cover in the open position.

FIG. 11 is a top plan view of the laptop computer illustrated in FIG. 1 showing the laptop computer cover in the open position.

FIG. 12 is a bottom plan view of the laptop computer illustrated in FIG. 1 showing the laptop computer cover in the open position.

FIG. 13 is a front elevation view of the laptop computer illustrated in FIG. 1 showing the laptop computer cover in the open position.

FIG. 14 is a rear elevation view of the laptop computer illustrated in FIG. 1 showing the laptop computer cover in the open position.

FIG. 15 is a right elevation view of the laptop computer illustrated in FIG. 1 showing the laptop computer cover in the open position.

FIG. 16 is a left elevation view of the laptop computer illustrated in FIG. 1 showing the laptop computer cover in the open position.

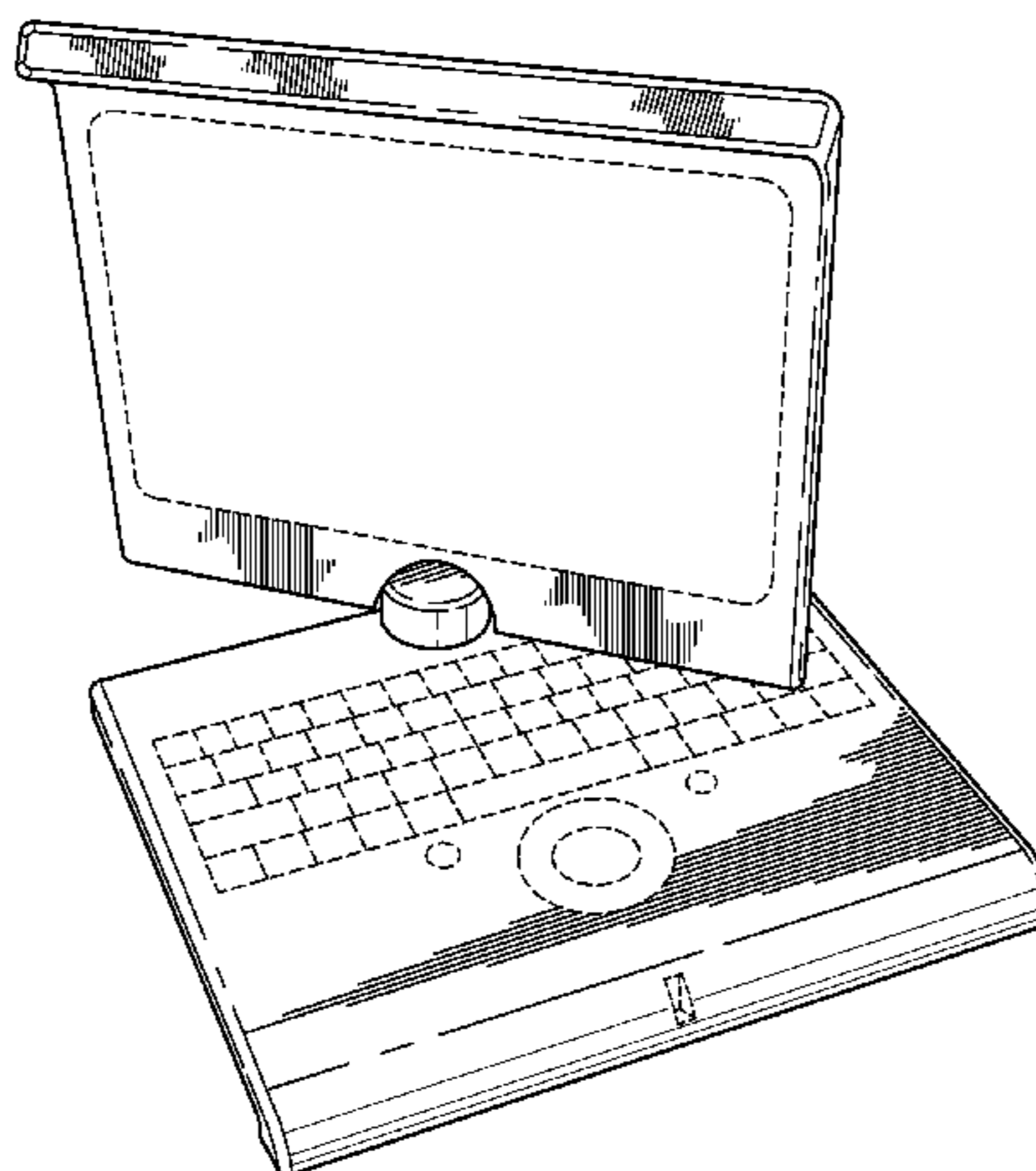
FIG. 17 is a top, left perspective view of the laptop computer illustrated in FIG. 1 showing the laptop computer cover in the open and pivoted position.

FIG. 18 is a top plan view of the laptop computer illustrated in FIG. 17; and,

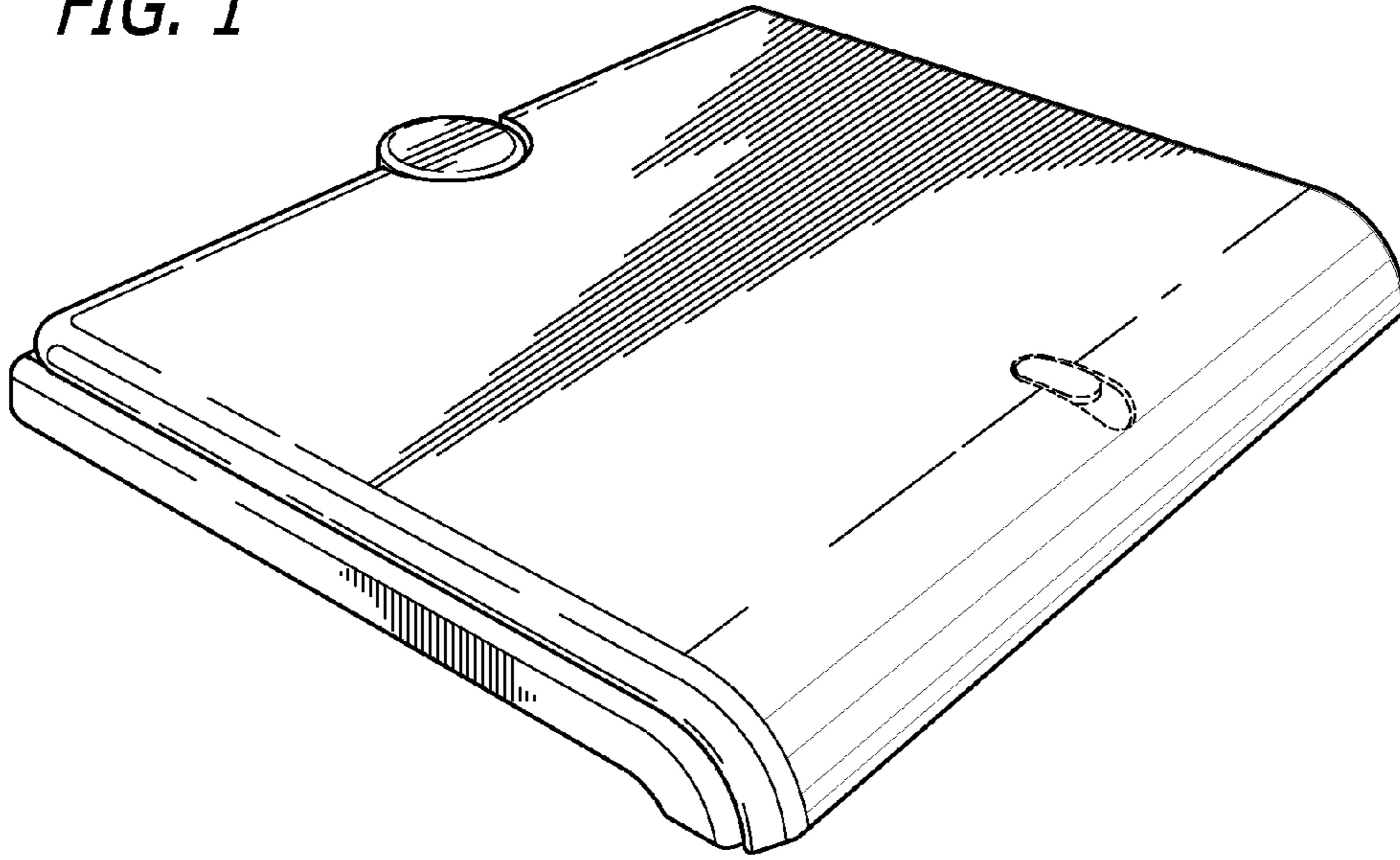
FIG. 19 is a left elevation view of the laptop computer illustrated in FIG. 17.

The portions of the laptop computer shown in broken lines are shown for environmental purposes only and form no part of the claimed design.

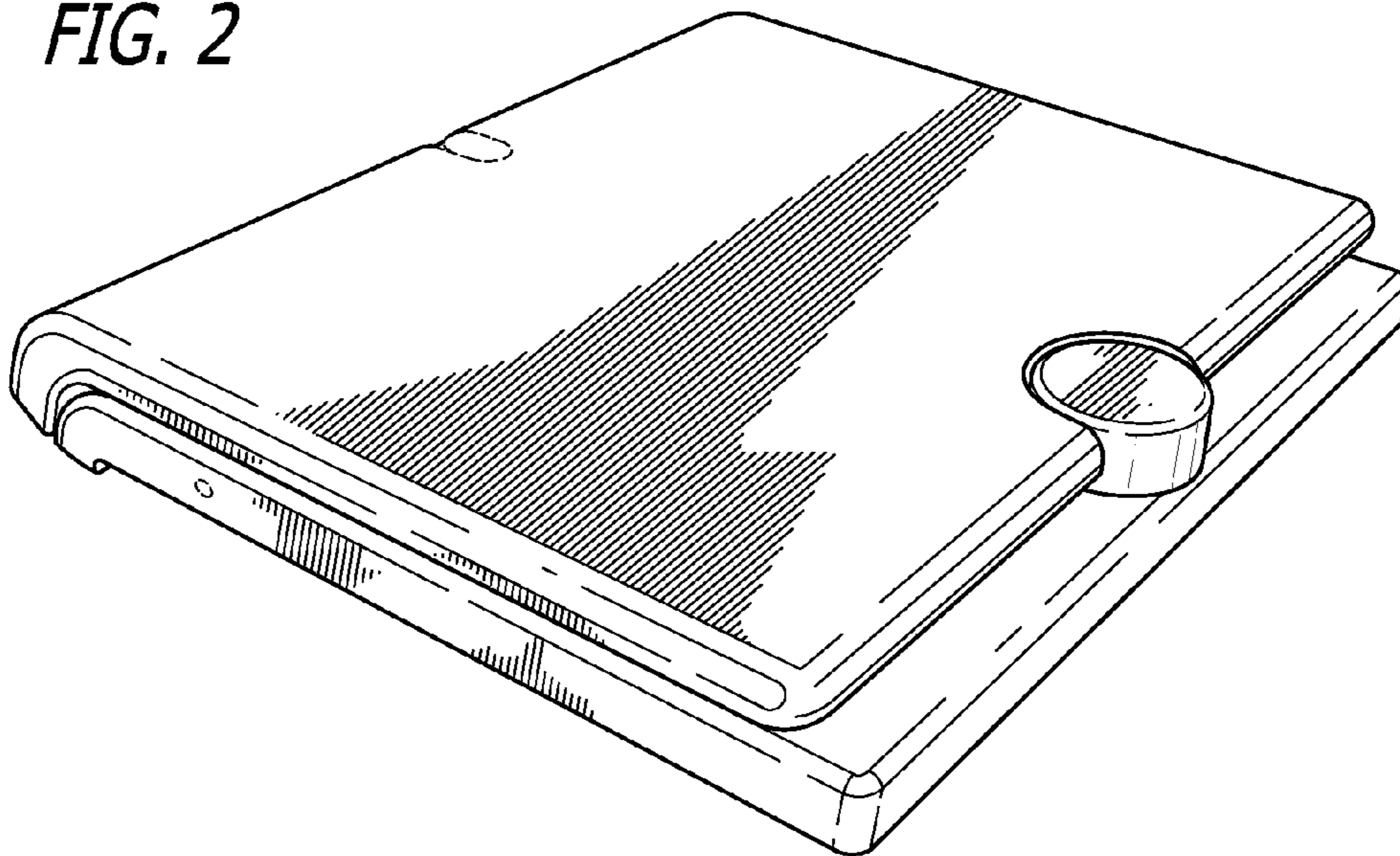
**1 Claim, 15 Drawing Sheets**



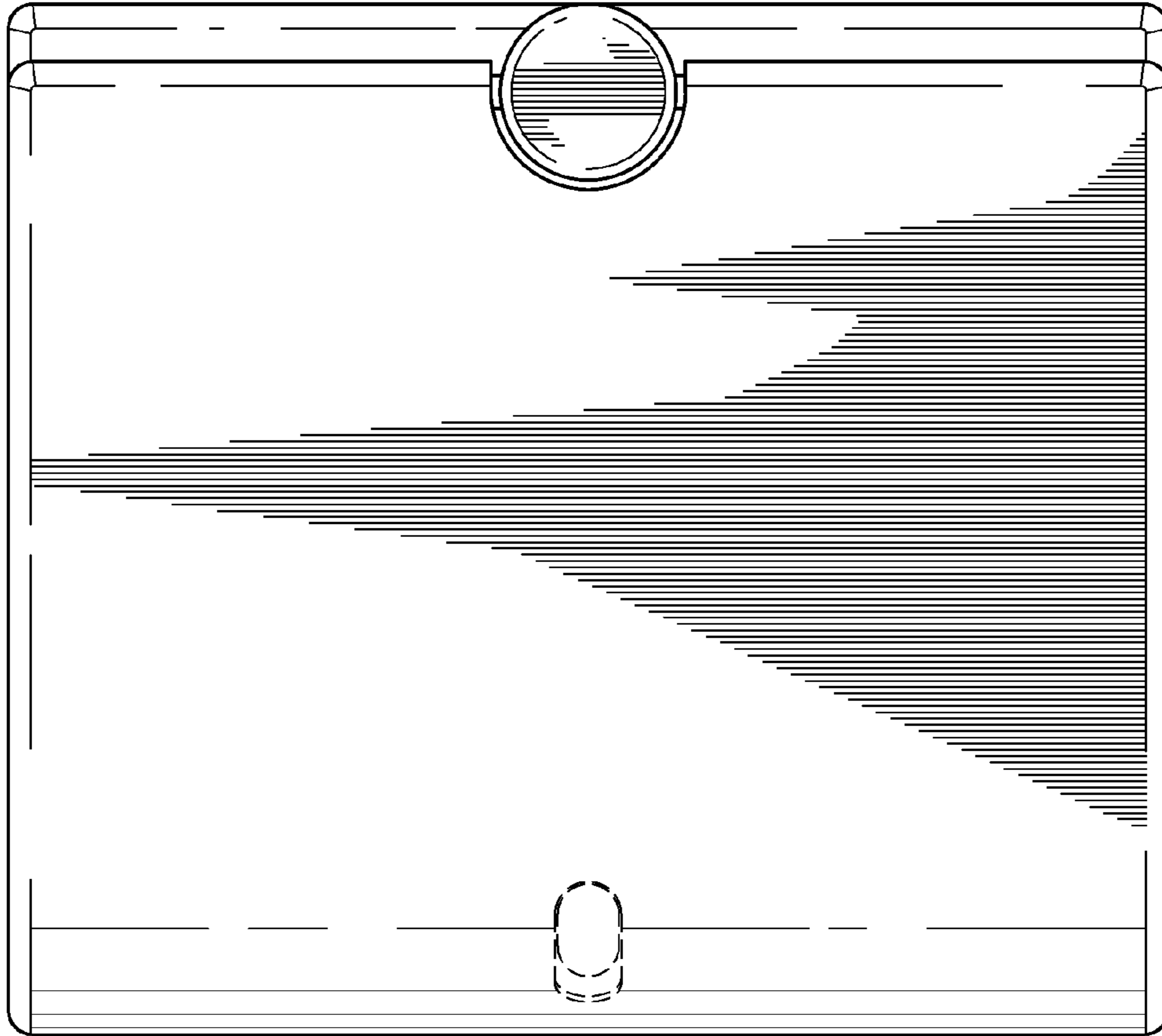
*FIG. 1*



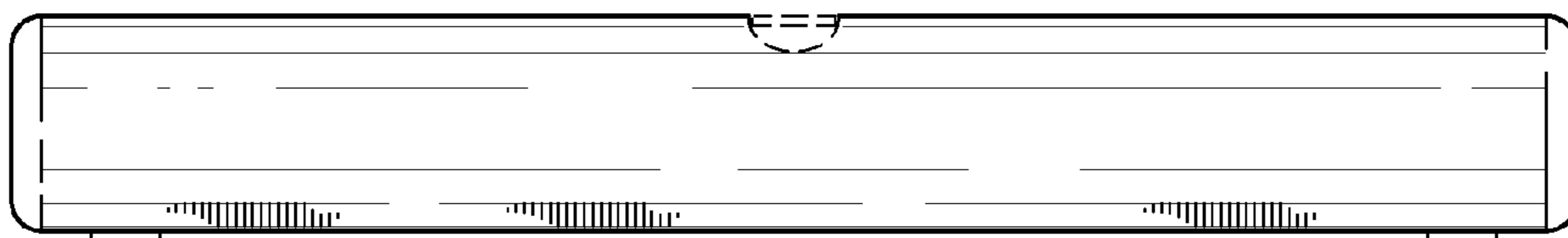
*FIG. 2*



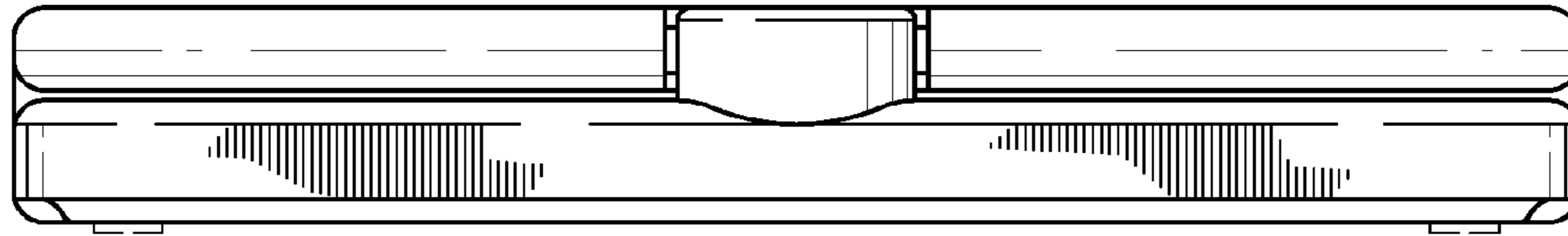
*FIG. 3*



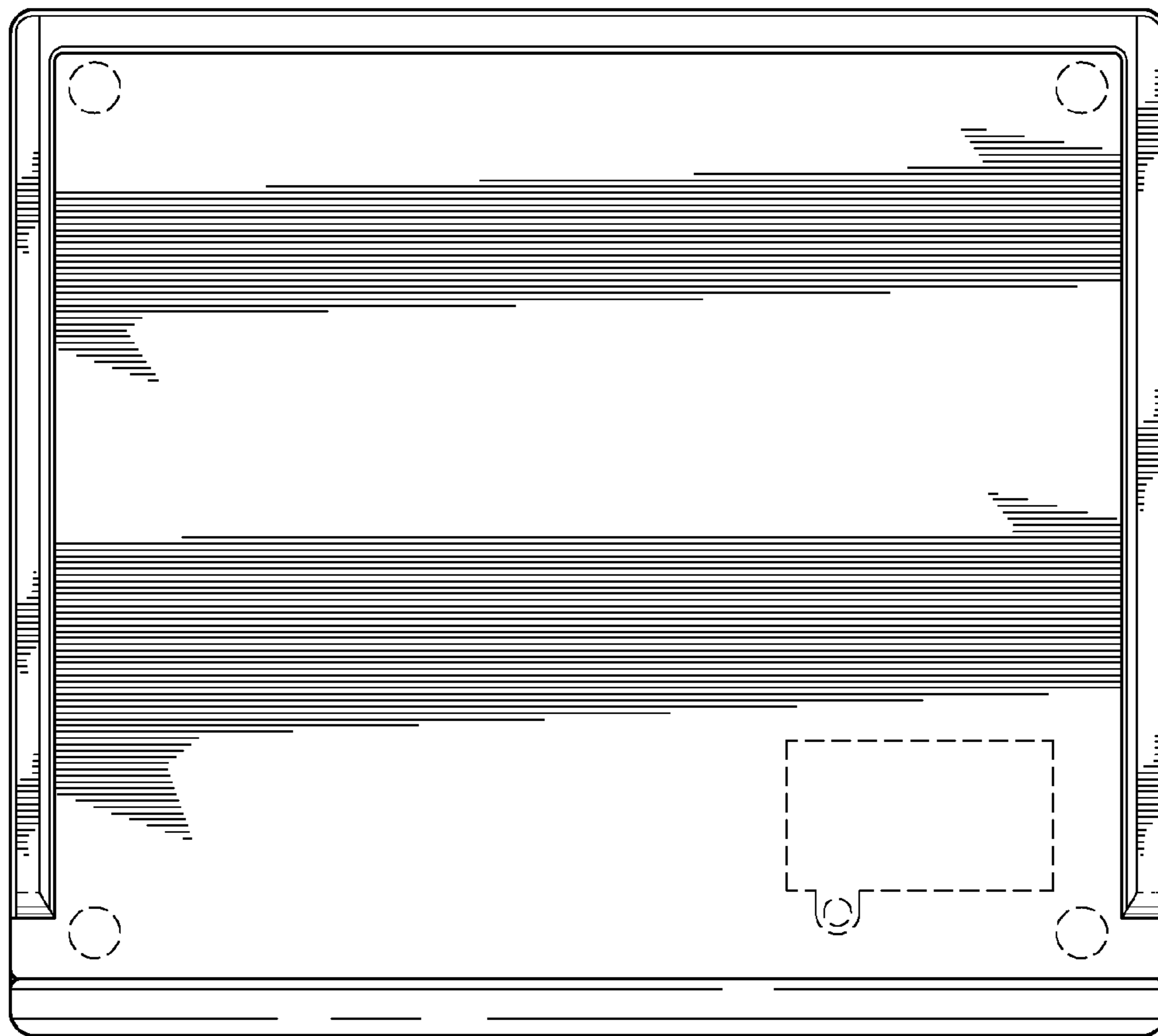
*FIG. 4*



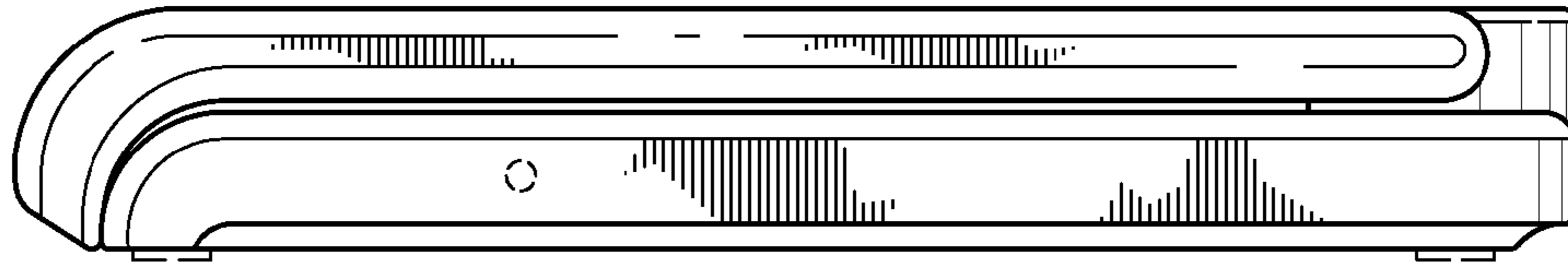
*FIG. 5*



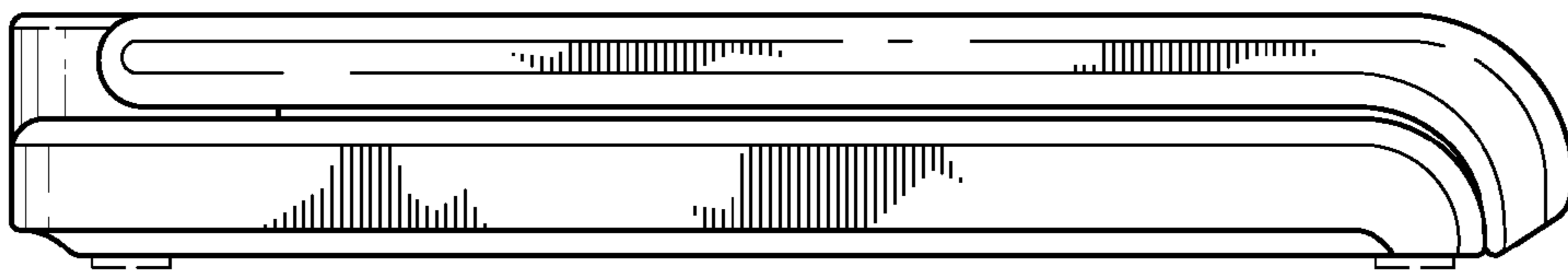
*FIG. 6*



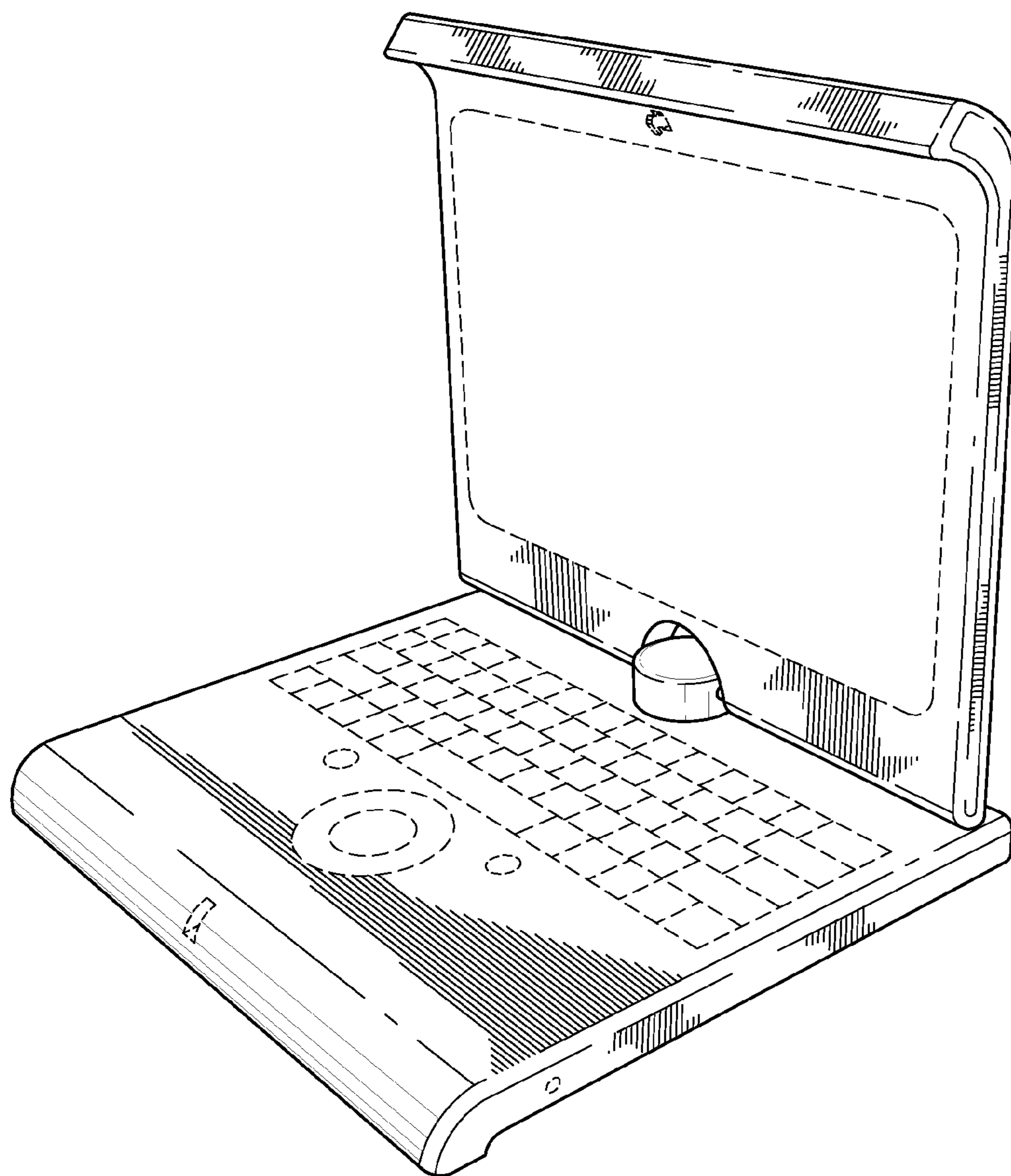
*FIG. 7*



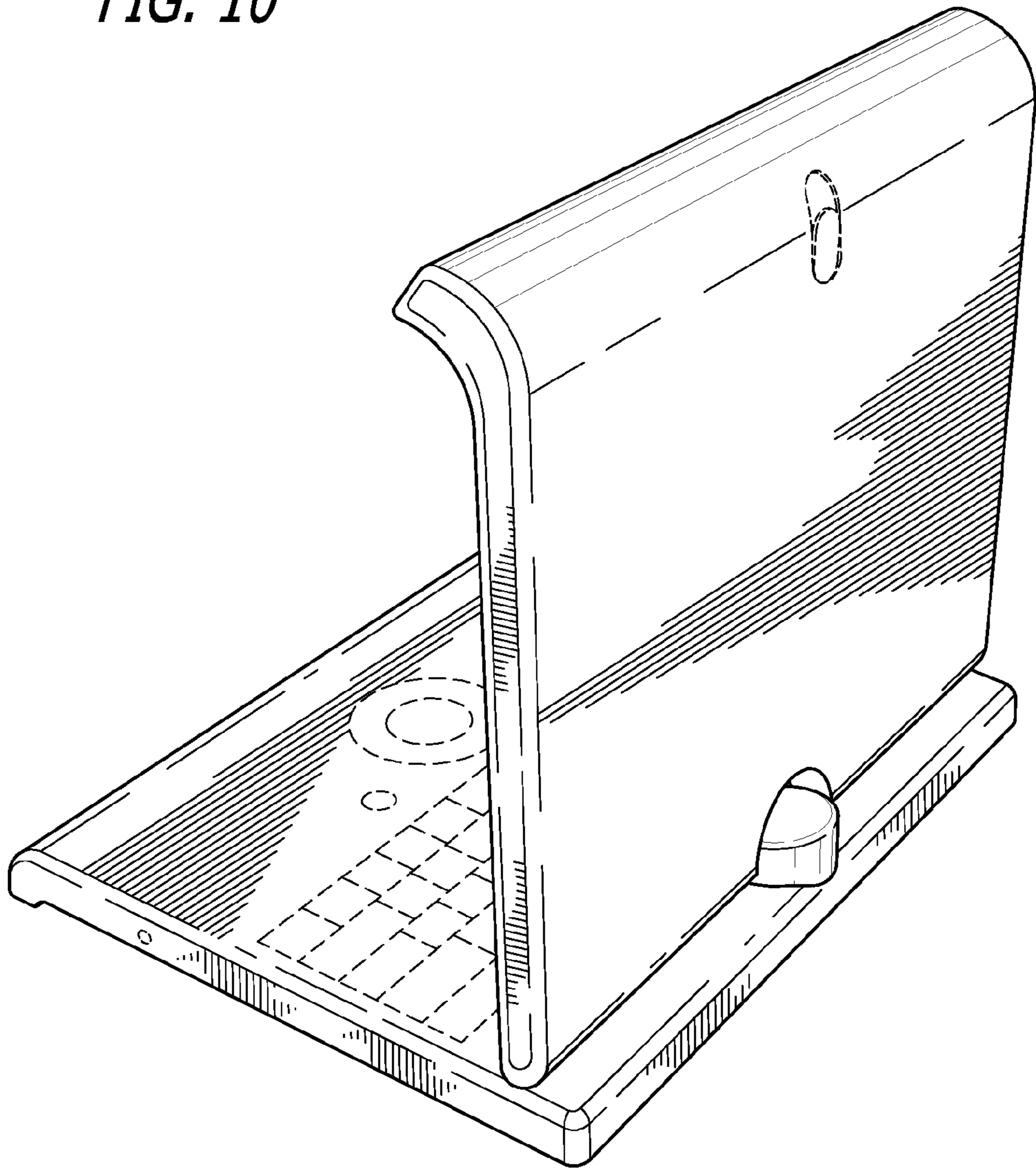
*FIG. 8*



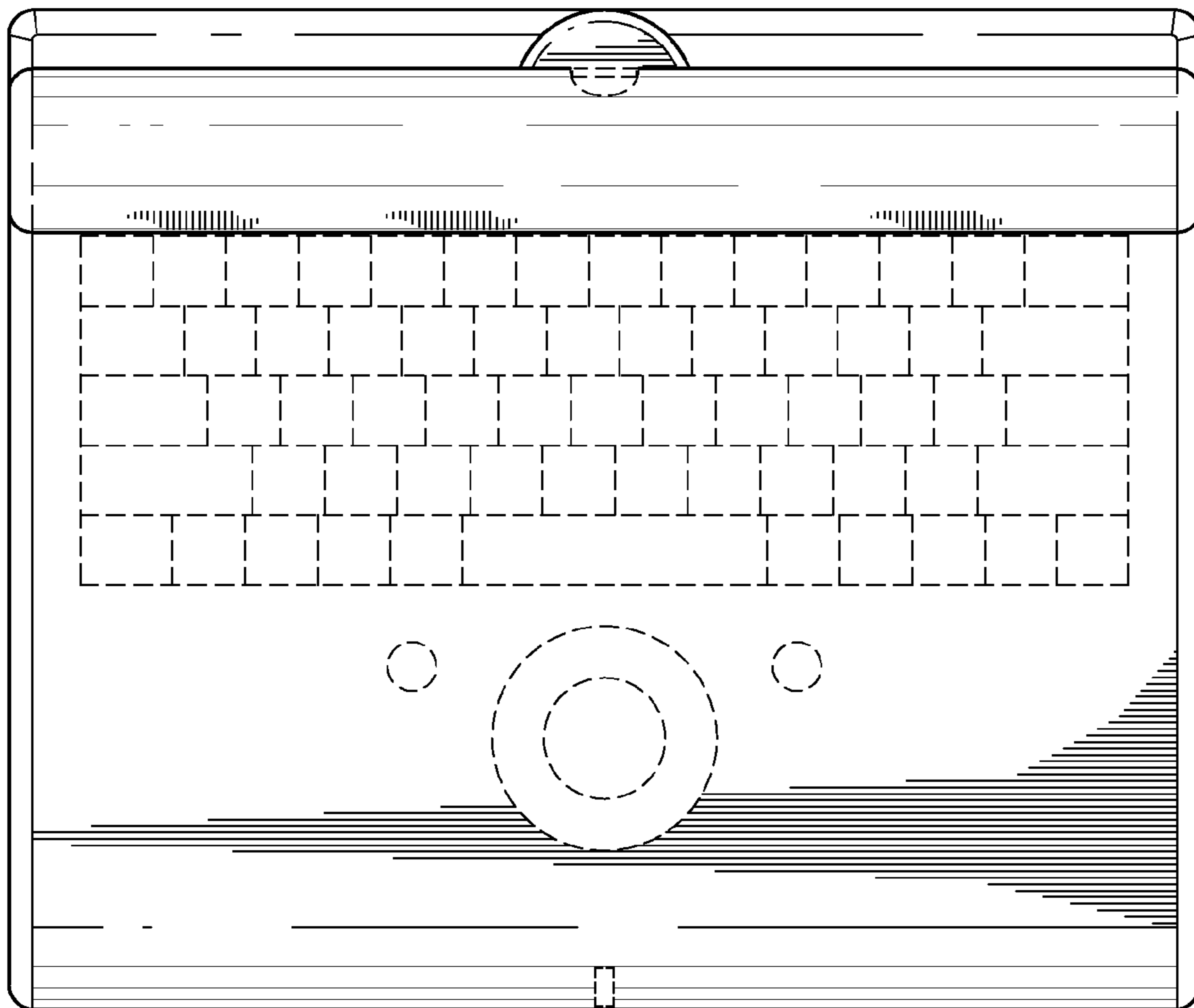
*FIG. 9*



*FIG. 10*

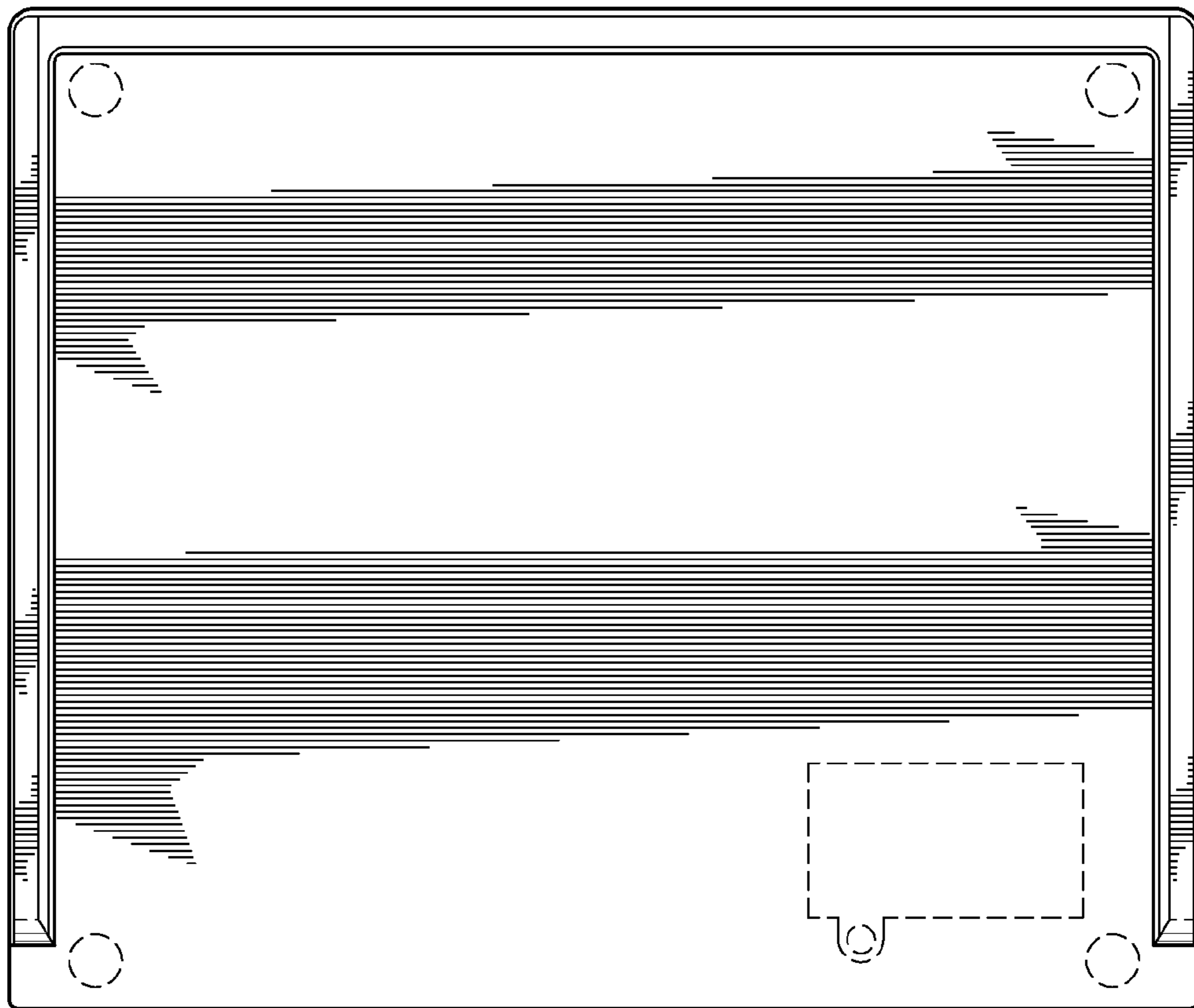


*FIG. 11*

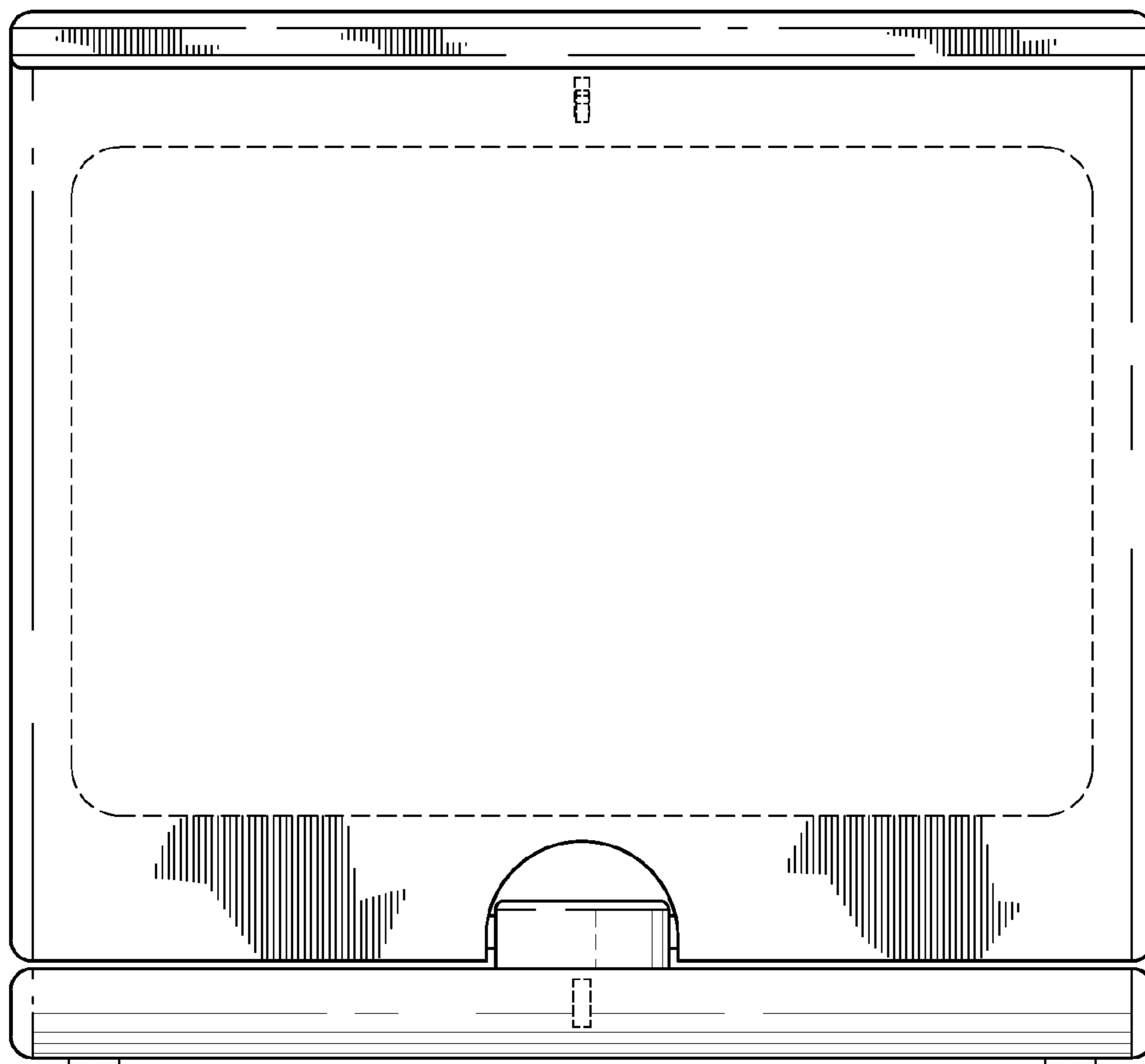




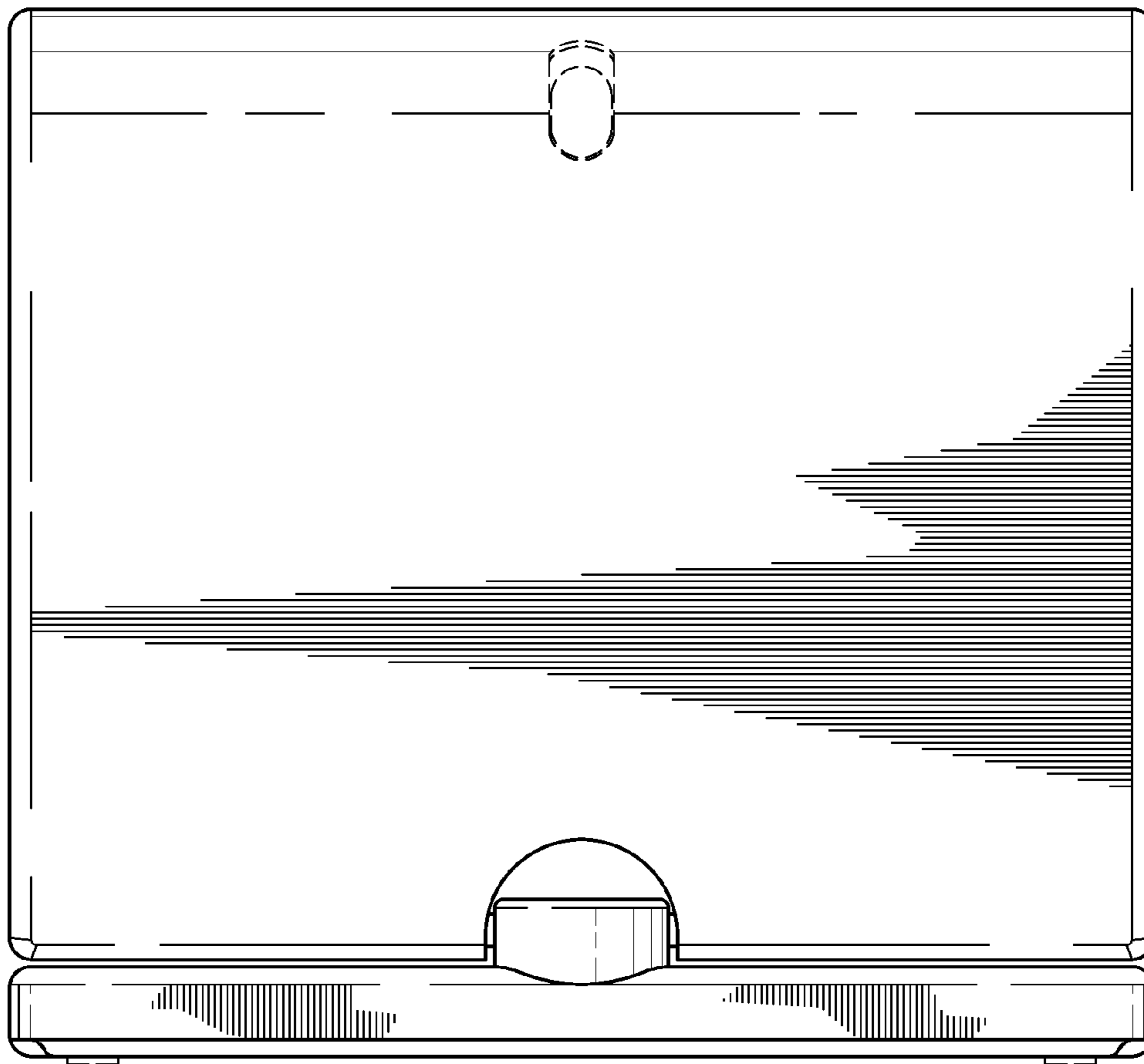
*FIG. 12*



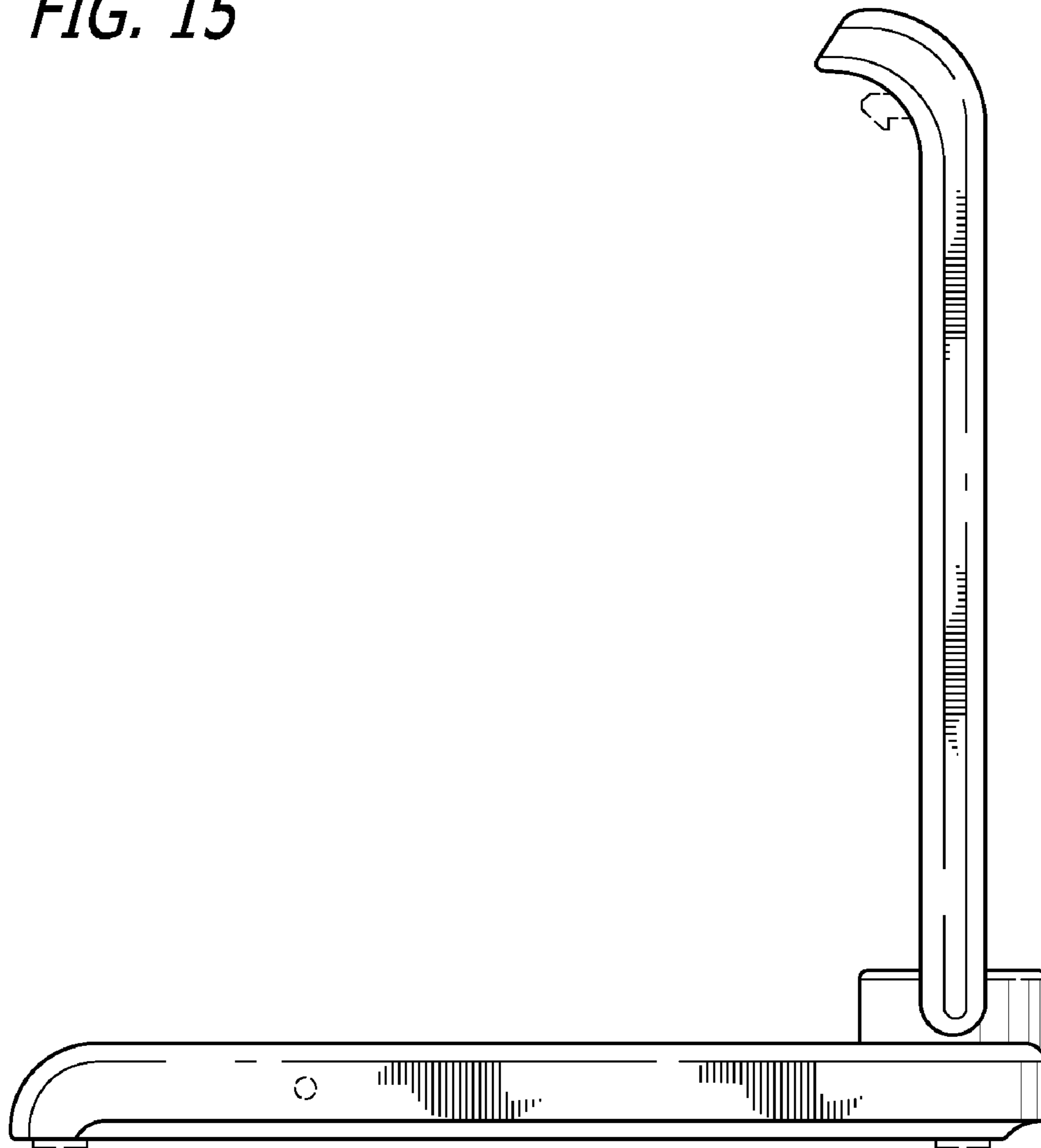
*FIG. 13*



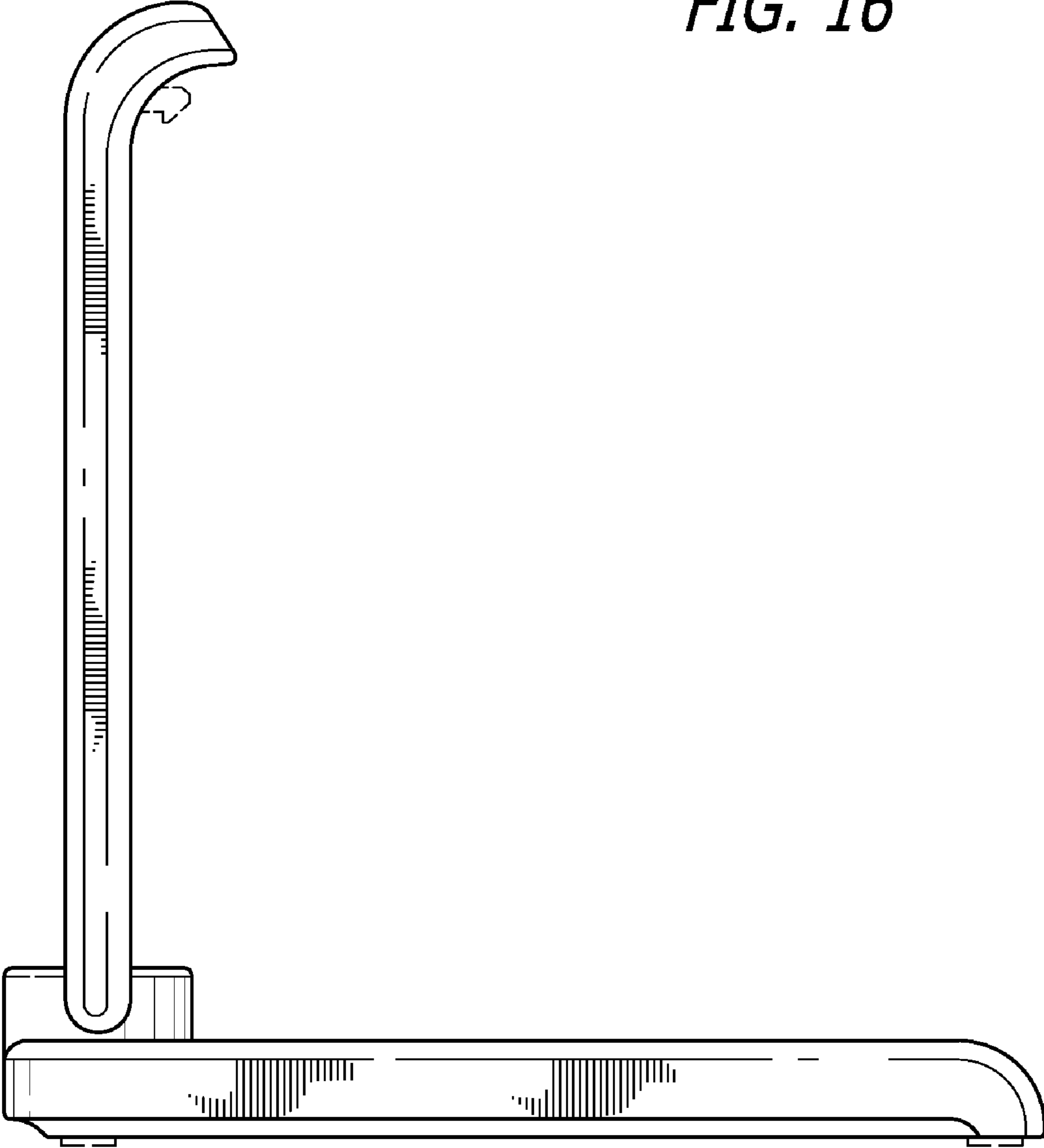
*FIG. 14*



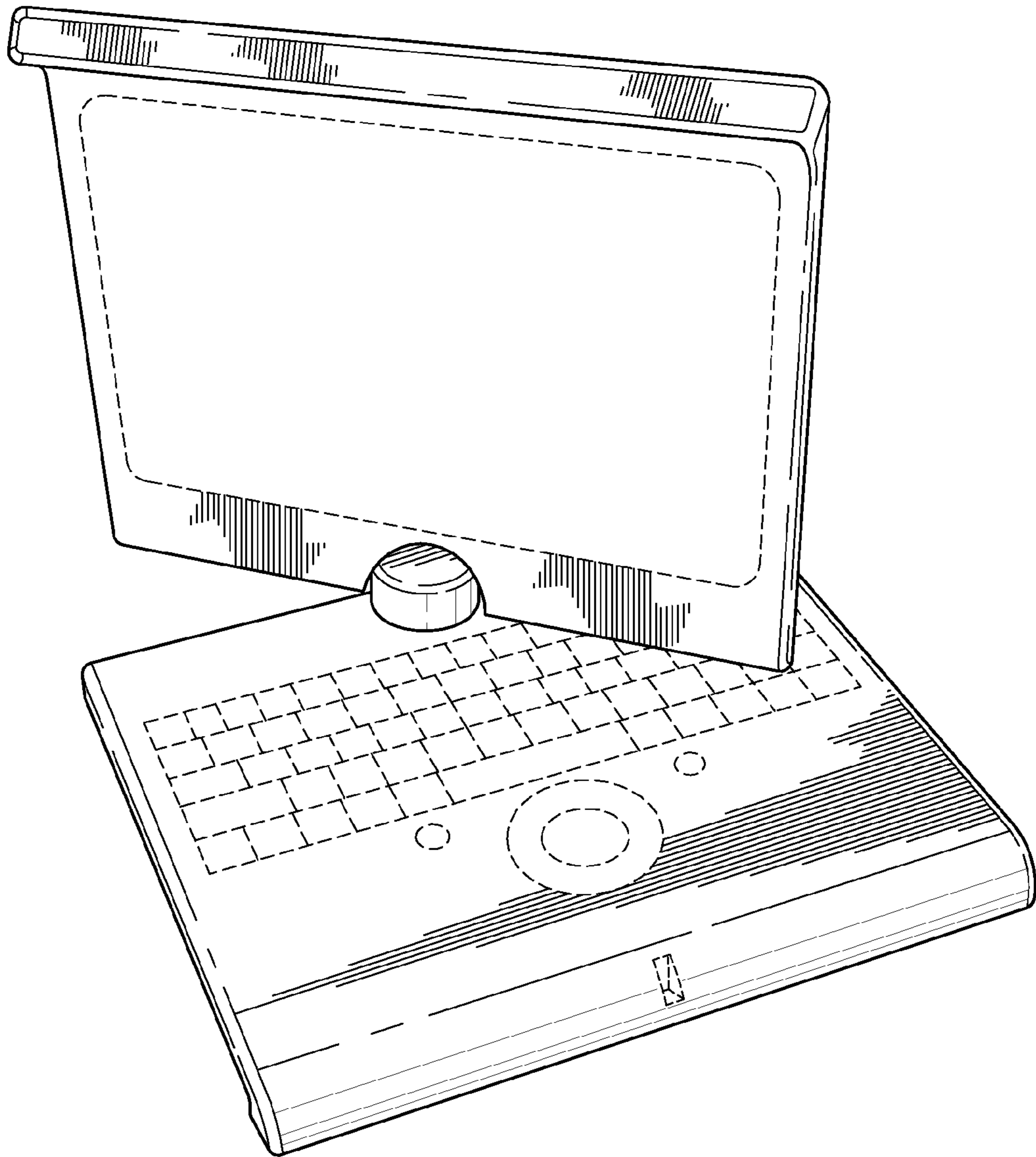
*FIG. 15*



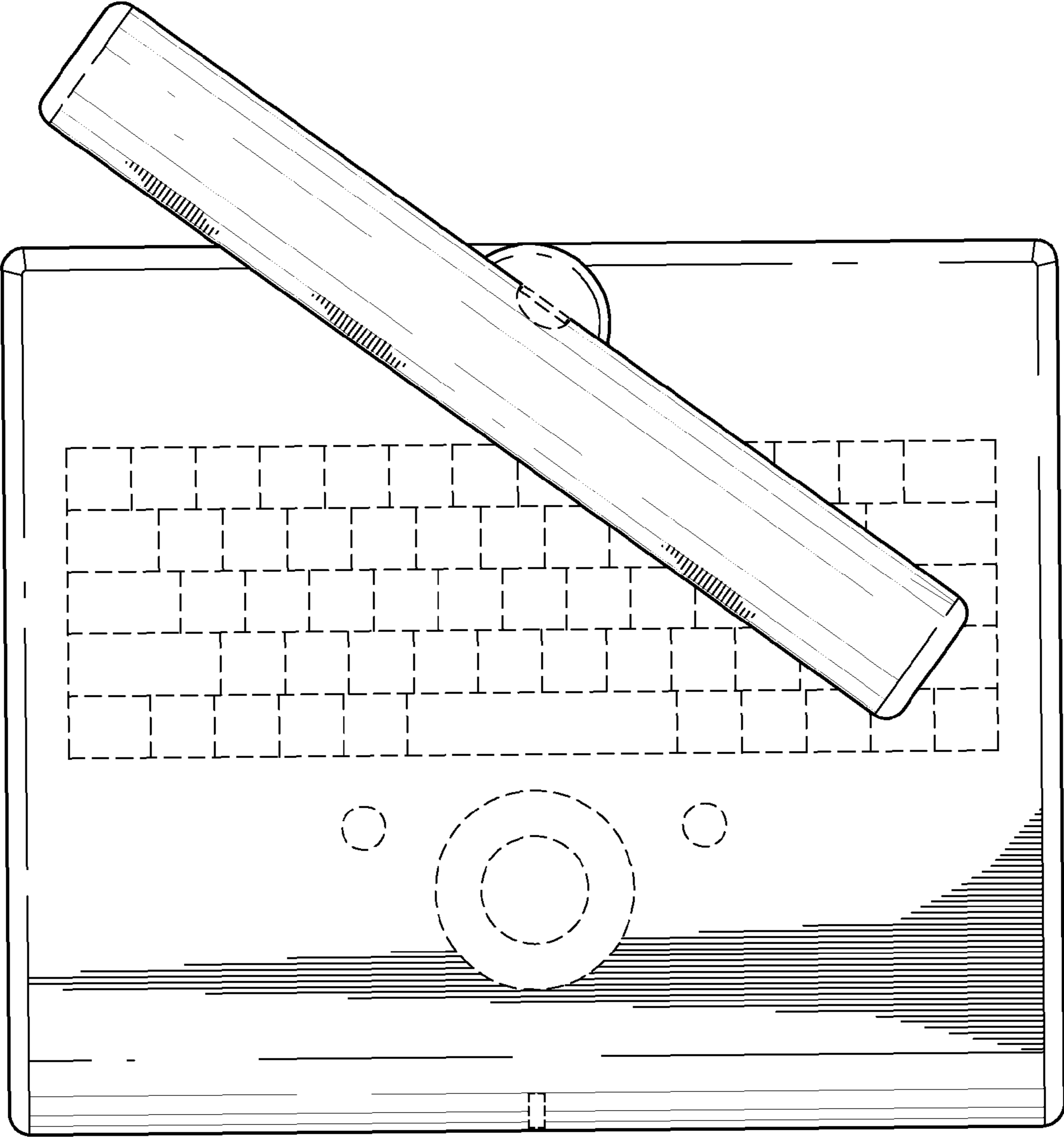
*FIG. 16*



*FIG. 17*



*FIG. 18*



*FIG. 19*

