



US00D643403S

(12) **United States Design Patent**
Andre et al.

(10) **Patent No.:** **US D643,403 S**

(45) **Date of Patent:** **** Aug. 16, 2011**

(54) **MEDIA PLAYER**

(75) Inventors: **Bartley K. Andre**, Menlo Park, CA (US); **Daniel J. Coster**, San Francisco, CA (US); **Daniele De Iuliis**, San Francisco, CA (US); **Richard P. Howarth**, San Francisco, CA (US); **Jonathan P. Ive**, San Francisco, CA (US); **Steve Jobs**, Palo Alto, CA (US); **Duncan Robert Kerr**, San Francisco, CA (US); **Matthew Dean Rohrbach**, San Francisco, CA (US); **Douglas B. Satzger**, Menlo Park, CA (US); **Calvin Q. Seid**, Palo Alto, CA (US); **Vincent Keane Seid**, legal representative, Los Gatos, CA (US); **Christopher J. Stringer**, Woodside, CA (US); **Eugene Antony Whang**, San Francisco, CA (US)

(73) Assignee: **Apple Inc.**, Cupertino, CA (US)

(**) Term: **14 Years**

(21) Appl. No.: **29/384,863**

(22) Filed: **Feb. 4, 2011**

Related U.S. Application Data

(63) Continuation of application No. 29/368,362, filed on Aug. 23, 2010, now Pat. No. Des. 633,470, which is a continuation of application No. 29/353,204, filed on Jan. 5, 2010, now Pat. No. Des. 622,261, which is a continuation of application No. 29/333,540, filed on Mar. 11, 2009, now Pat. No. Des. 610,126, which is a continuation of application No. 11/882,003, filed on Jul. 30, 2007, which is a continuation of application No. 11/806,957, filed on Jun. 5, 2007, now Pat. No. 7,333,092, which is a continuation of application No. 11/386,238, filed on Mar. 21, 2006, now Pat. No. 7,348,967, which is a continuation of application No. 10/188,182, filed on Jul. 1, 2002, now Pat. No. 7,046,230.

(51) **LOC (9) Cl.** **14-03**

(52) **U.S. Cl.** **D14/203.7; D14/203.3; D14/496**

(58) **Field of Classification Search** D14/496, D14/401, 435, 474, 483, 217, 137, 138, 160, D14/168, 356; 345/156, 169, 173-179, 905; 715/727-729, 864; 710/1, 5, 8; 713/1, 600; 455/1.1, 1, 7, 73, 344-347, 93, 95, 3.01-3.06, 455/550.1, 573.1; 370/342-344; 369/1, 369/2, 6, 12; 463/43-47; 273/148 B
See application file for complete search history.

(56) **References Cited**

U.S. PATENT DOCUMENTS

5,661,632 A 8/1997 Register
(Continued)

Primary Examiner — Prabhakar Deshmukh

(74) *Attorney, Agent, or Firm* — Sterne, Kessler, Goldstein & Fox PLLC

(57) **CLAIM**

The ornamental design for a media player, as shown and described.

DESCRIPTION

This application is also related to U.S. Design patent application Ser. No. 29/153,169, filed on Oct. 22, 2001, now U.S. Design Pat. No. D469,109, the disclosures of which are incorporated in their entirety herein by reference thereto.

FIG. 1 is a front perspective view of a media player showing our new design;

FIG. 2 is a front view thereof;

FIG. 3 is a left side view thereof;

FIG. 4 is a right side view thereof;

FIG. 5 is a bottom view thereof;

FIG. 6 is a top view thereof; and,

FIG. 7 is a rear view thereof.

The broken lines in the Figures show portions of the media device which form no part of the claimed design.

The shade lines in the Figures show contour and not surface ornamentation.

1 Claim, 5 Drawing Sheets

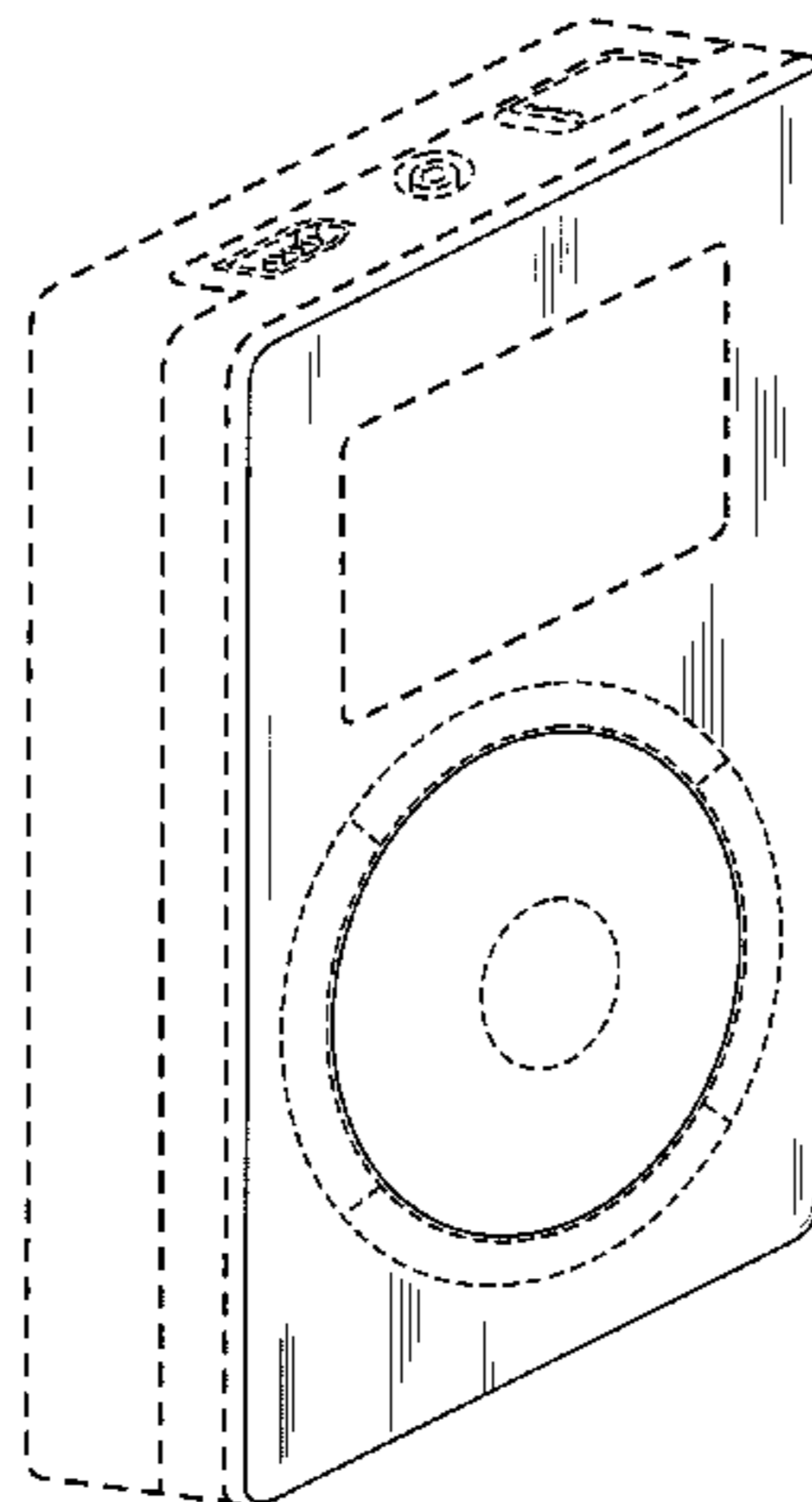

US D643,403 S

Page 2

U.S. PATENT DOCUMENTS

D412,940 S	8/1999	Kato et al.	6,593,914 B1 *	7/2003	Nuovo et al.	345/169
D425,885 S	5/2000	Amron	D516,576 S *	3/2006	Ive et al.	D14/203.7
6,227,966 B1	5/2001	Yokoi	7,046,230 B2	5/2006	Zadesky et al.	
6,254,477 B1	7/2001	Sasaki et al.	D527,015 S *	8/2006	Yang	D14/203.7
D448,810 S	10/2001	Goto	D532,425 S *	11/2006	Kim	D14/203.7
6,314,483 B1	11/2001	Goto et al.	D538,822 S *	3/2007	Andre et al.	D14/203.7
D452,250 S	12/2001	Chan				

* cited by examiner

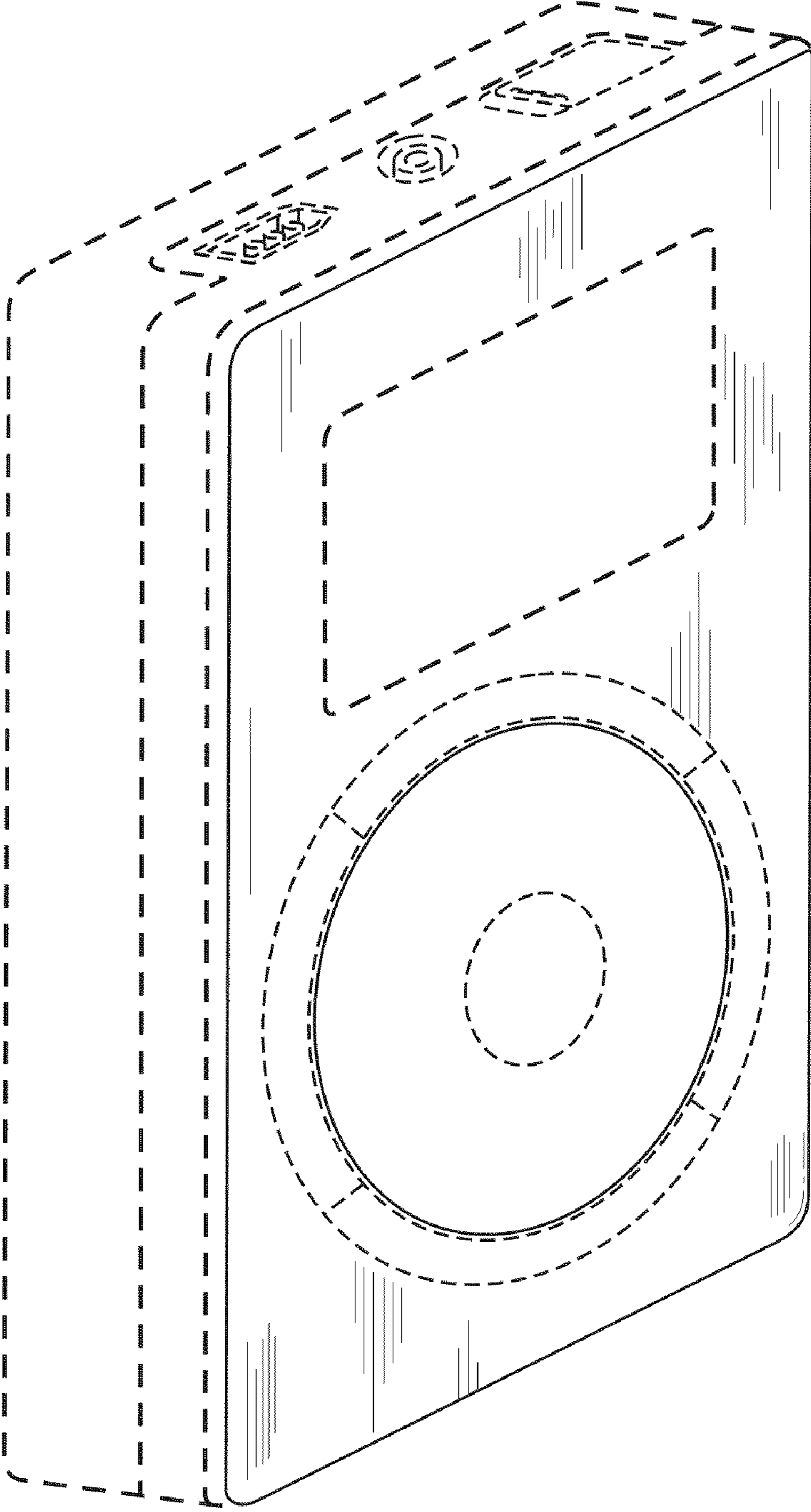

FIG. 1

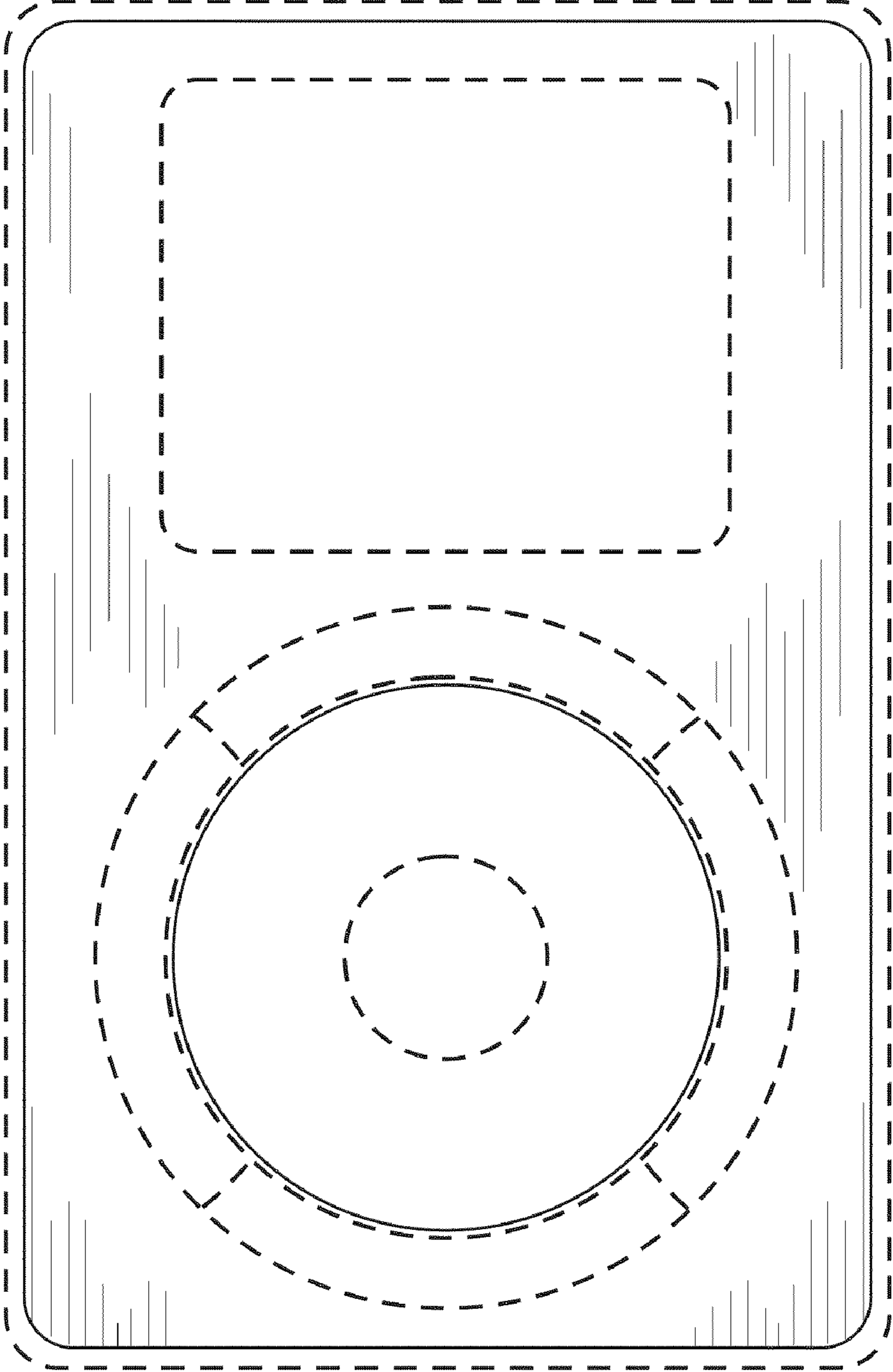

FIG. 2

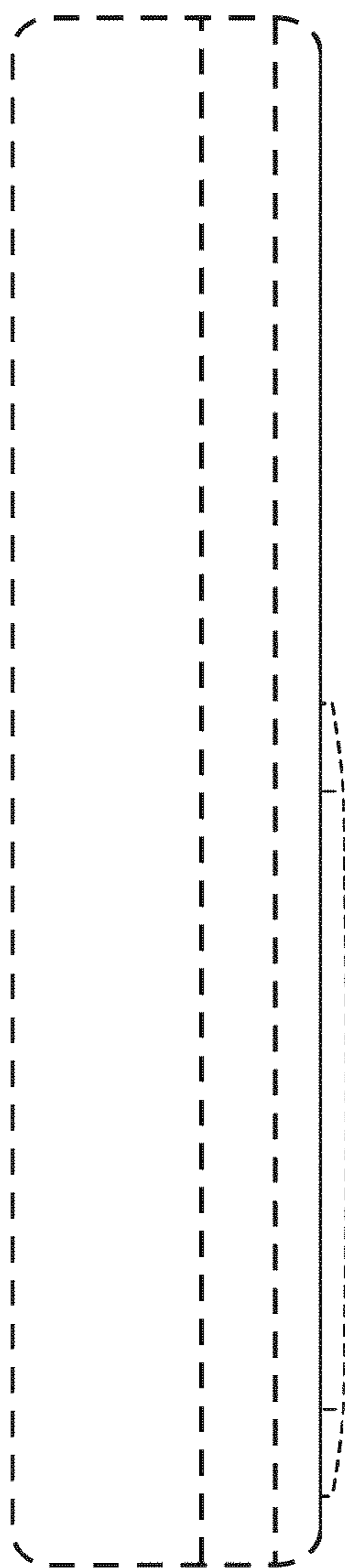

FIG. 3

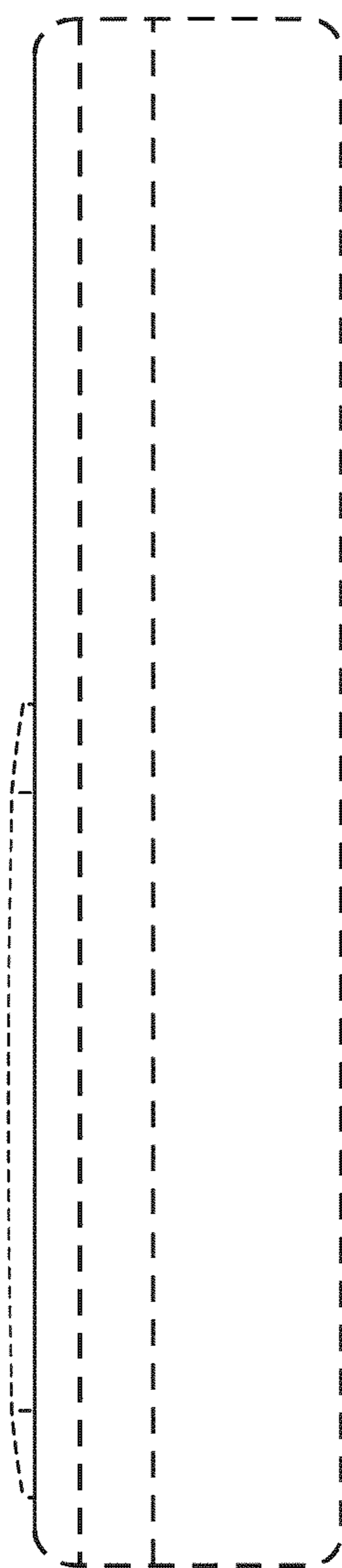

FIG. 4

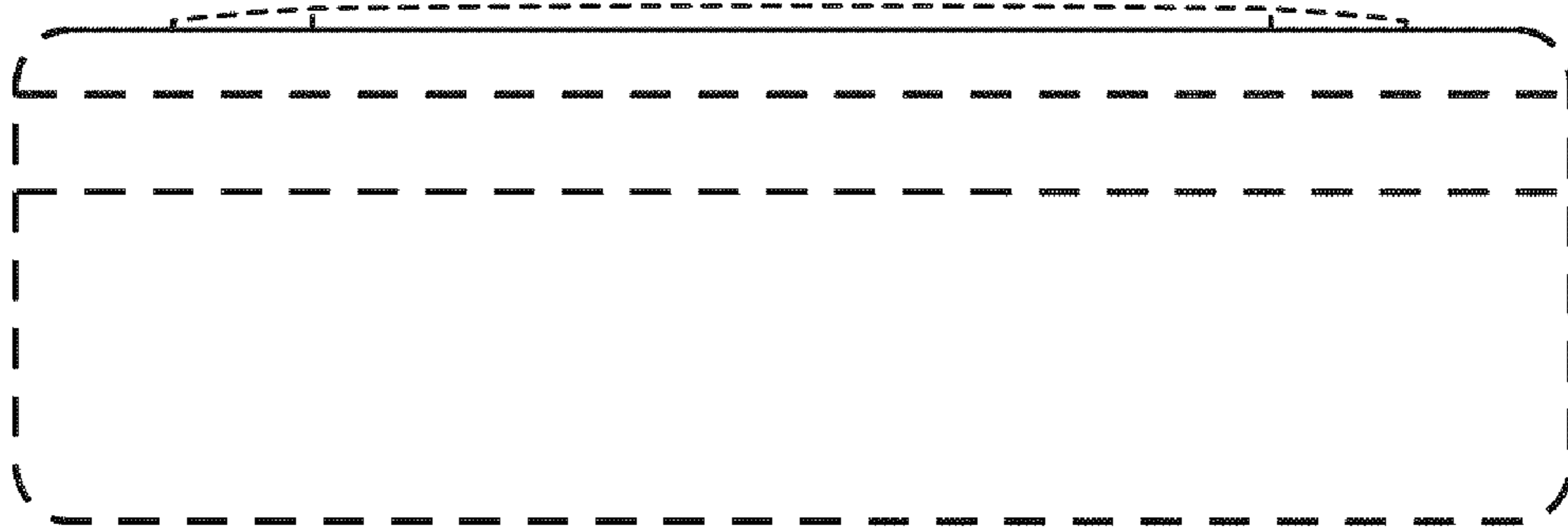

FIG. 5

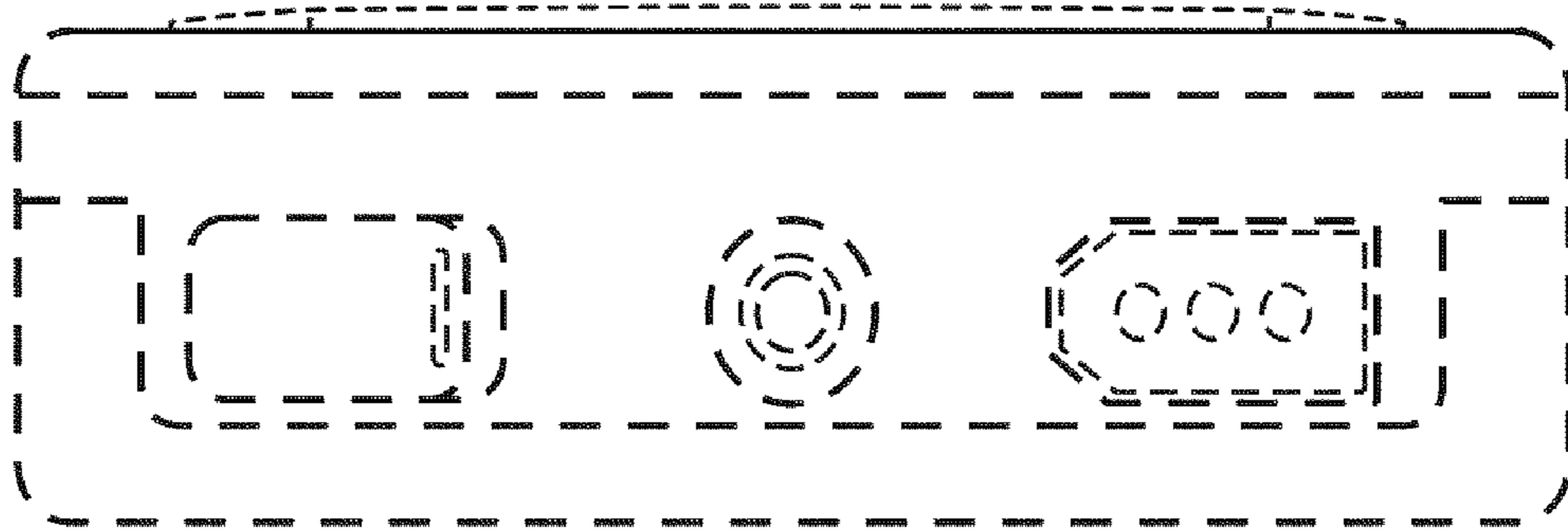

FIG. 6

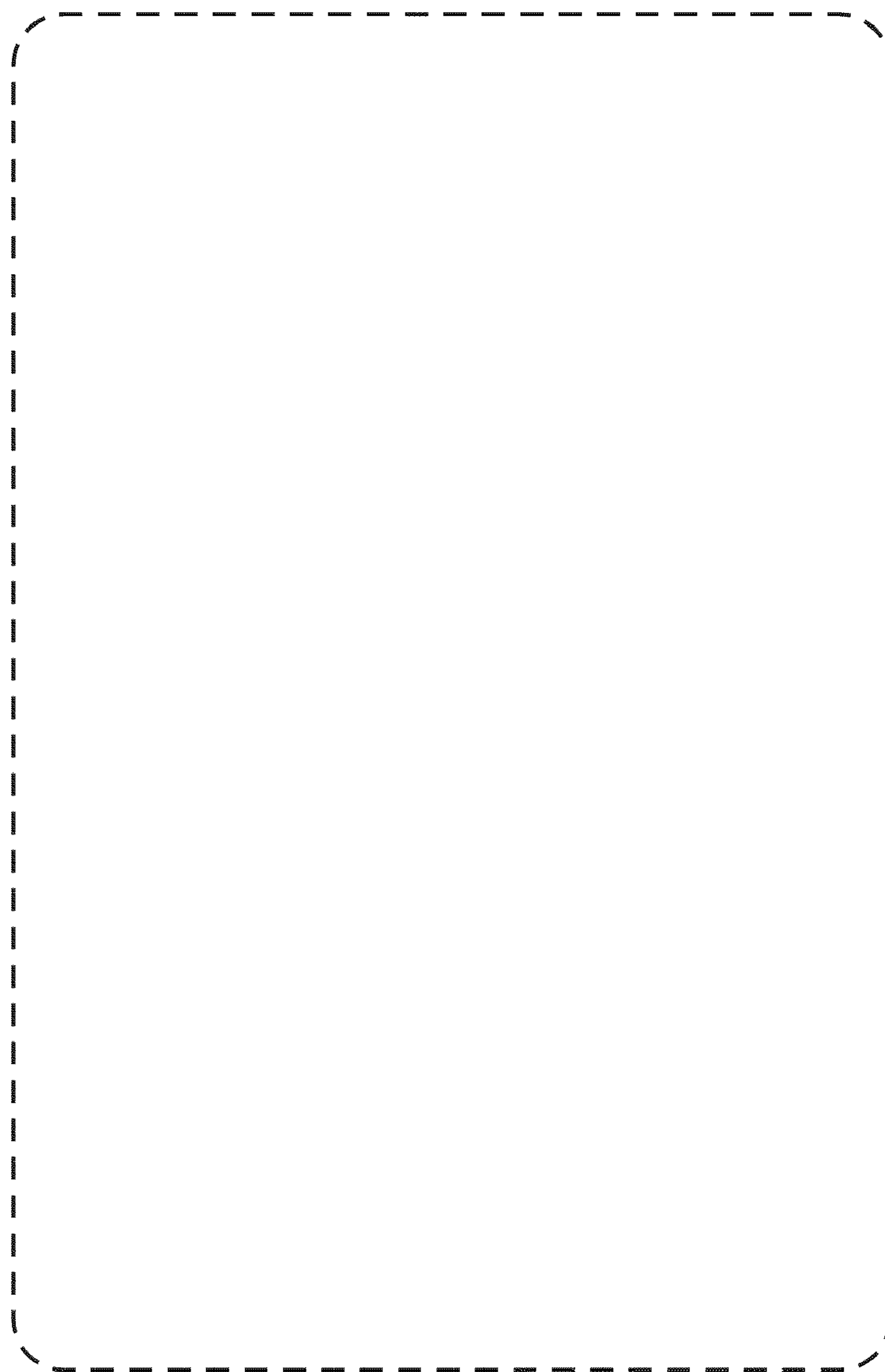

FIG. 7