



US00D643315S

(12) **United States Design Patent**
De Witt

(10) **Patent No.:** **US D643,315 S**

(45) **Date of Patent:** **** Aug. 16, 2011**

(54) **WATCH**

(75) **Inventor:** **Jérôme De Witt**, Vandoeuvres (CH)

(73) **Assignee:** **Montres Dewitt SA**, Meyrin (CH)

(**) **Term:** **14 Years**

(21) **Appl. No.:** **29/373,276**

(22) **Filed:** **Mar. 24, 2011**

(30) **Foreign Application Priority Data**

Sep. 27, 2010 (WO) DM/074 503

(51) **LOC (9) Cl.** **10-02**

(52) **U.S. Cl.** **D10/39**

(58) **Field of Classification Search** D10/30-39;
368/276, 281, 282, 285, 294, 295, 238

See application file for complete search history.

(56) **References Cited**

U.S. PATENT DOCUMENTS

D262,692 S *	1/1982	Kurowsky	D10/39
D287,472 S *	12/1986	Hotz	D10/39
D297,817 S *	9/1988	Guan	D10/30
D318,626 S *	7/1991	Wunderman	D10/32
D326,232 S *	5/1992	Kurebayashi	D10/39
D328,866 S *	8/1992	Deleskiewicz	D10/39

D371,745 S *	7/1996	Wunderman	D10/32
D378,355 S *	3/1997	Charriol	D10/30
D379,769 S *	6/1997	Schoepfer	D10/39
D380,698 S *	7/1997	Paredes	D10/128
D384,295 S *	9/1997	Riley	D10/30
D390,128 S *	2/1998	Toribio	D10/32
D390,129 S *	2/1998	Brzezinski	D10/32
D390,132 S *	2/1998	Rosenthal	D10/39
D390,148 S *	2/1998	Brzezinski	D10/30
D484,815 S *	1/2004	Baumann	D10/32
D558,614 S *	1/2008	Strasser	D10/38
D609,587 S *	2/2010	Lalo	D10/38

* cited by examiner

Primary Examiner — Lucy Lieberman

(74) *Attorney, Agent, or Firm* — Clifford W. Browning;
Krieg DeVault LLP

(57) **CLAIM**

The ornamental design for a watch, as shown and described.

DESCRIPTION

FIG. 1 is a perspective view of the watch of the present invention.

FIG. 2 is a bottom view of the watch of FIG. 1.

FIG. 3 is a top view of the watch of FIG. 1.

FIG. 4 is a right side view of the watch of FIG. 1.

FIG. 5 is a left side view of the watch of FIG. 1.

FIG. 6 is a rear view of the watch of FIG. 1; and,

FIG. 7 is a front view of the watch of FIG. 1.

1 Claim, 1 Drawing Sheet

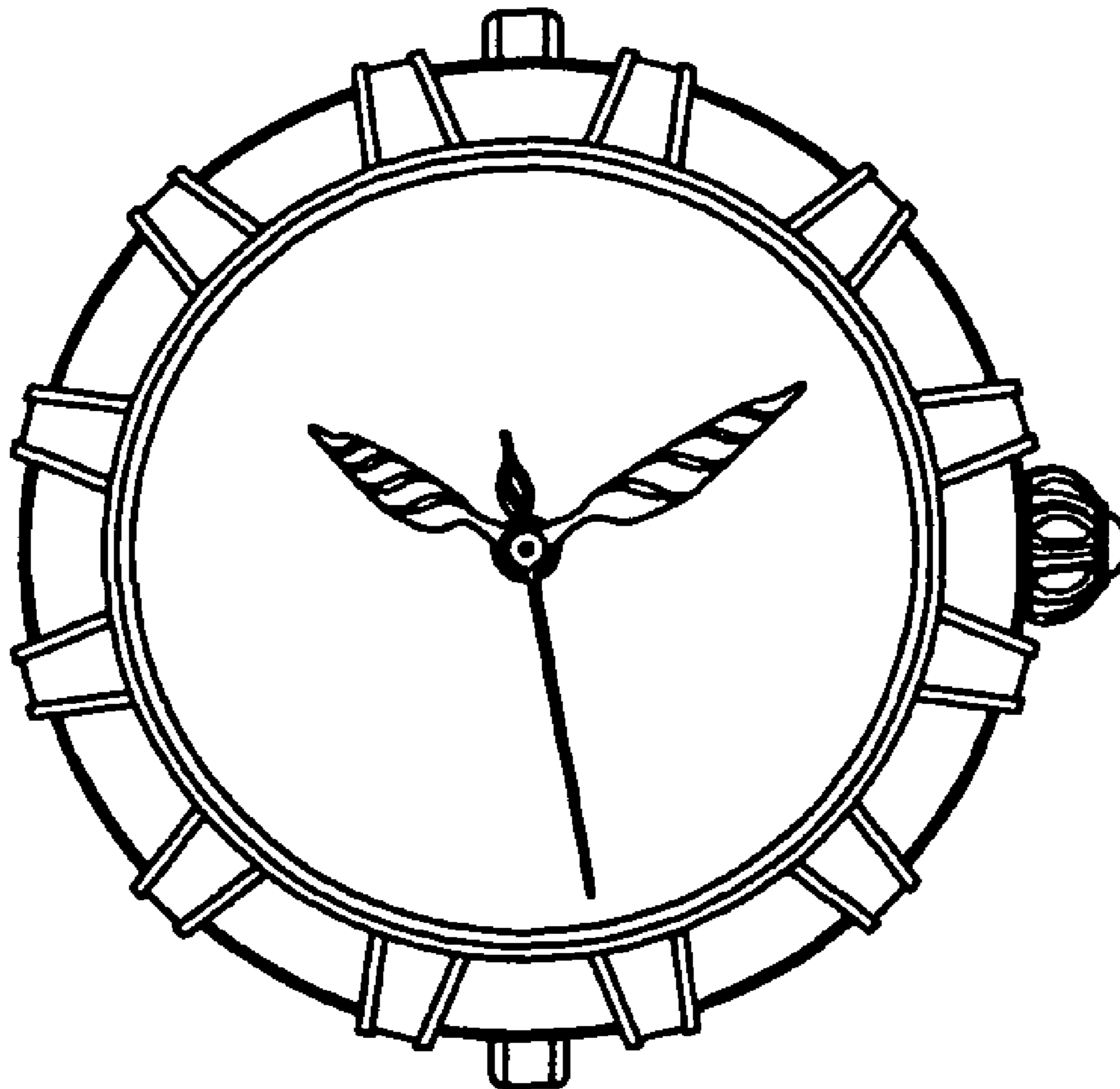

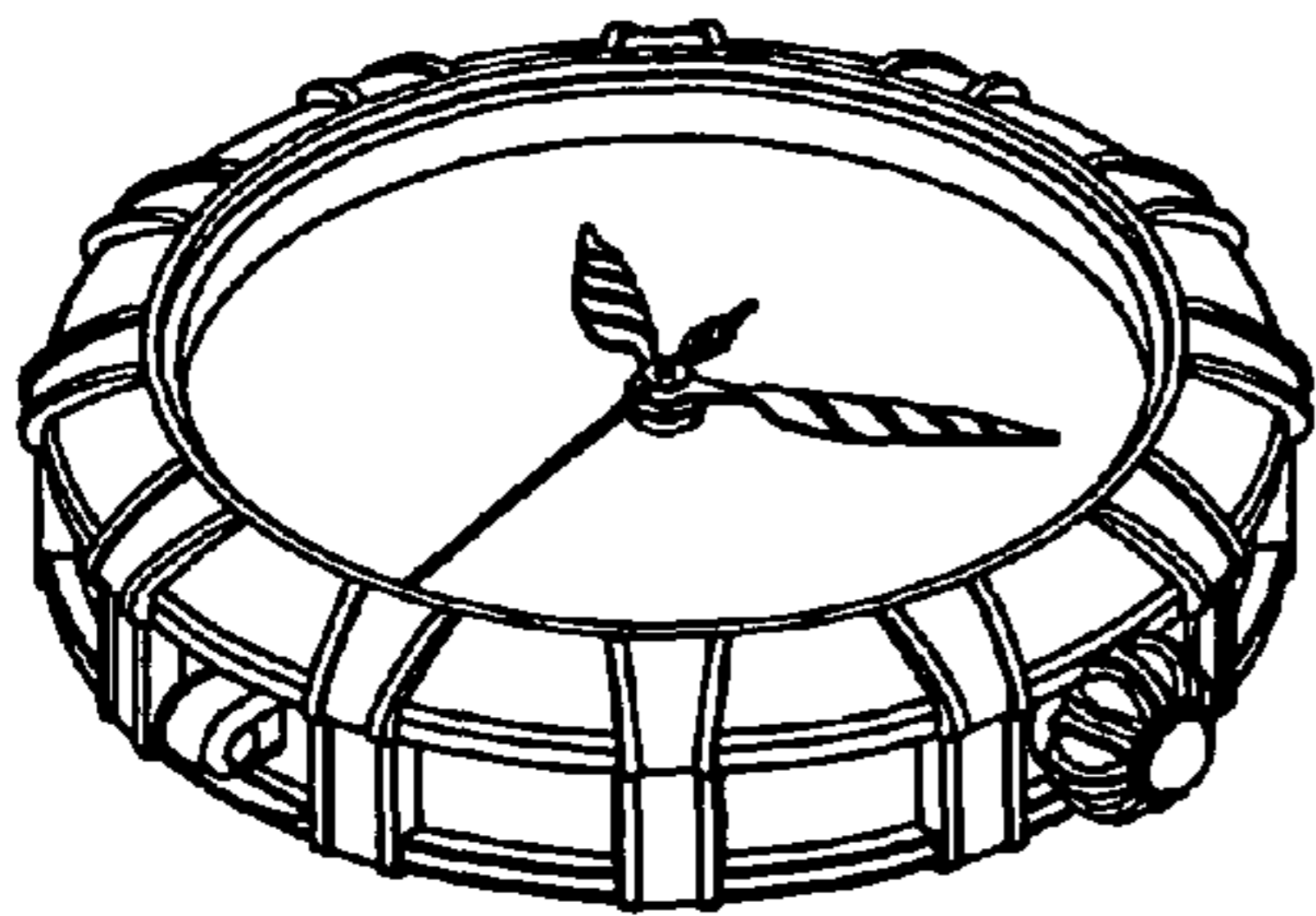

FIG. 1

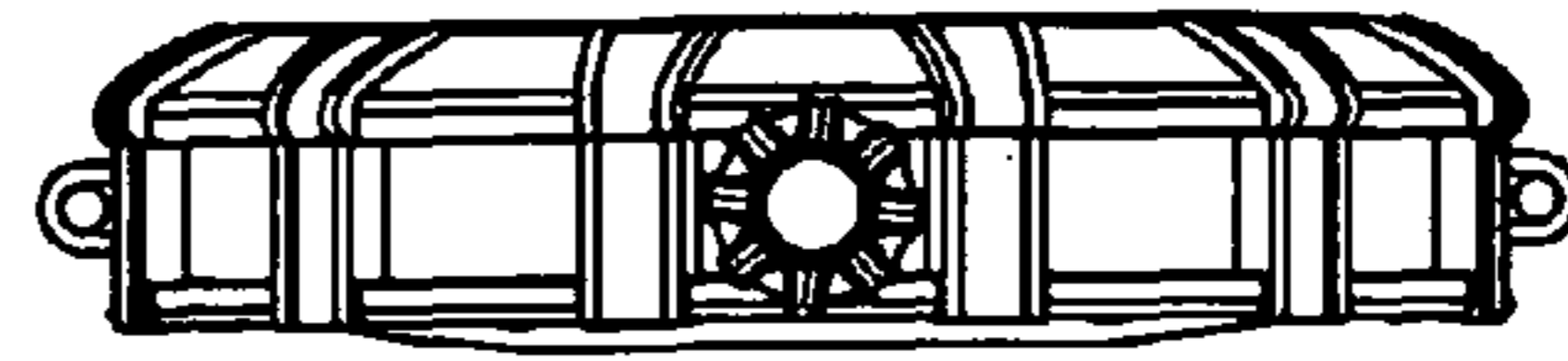

FIG. 4

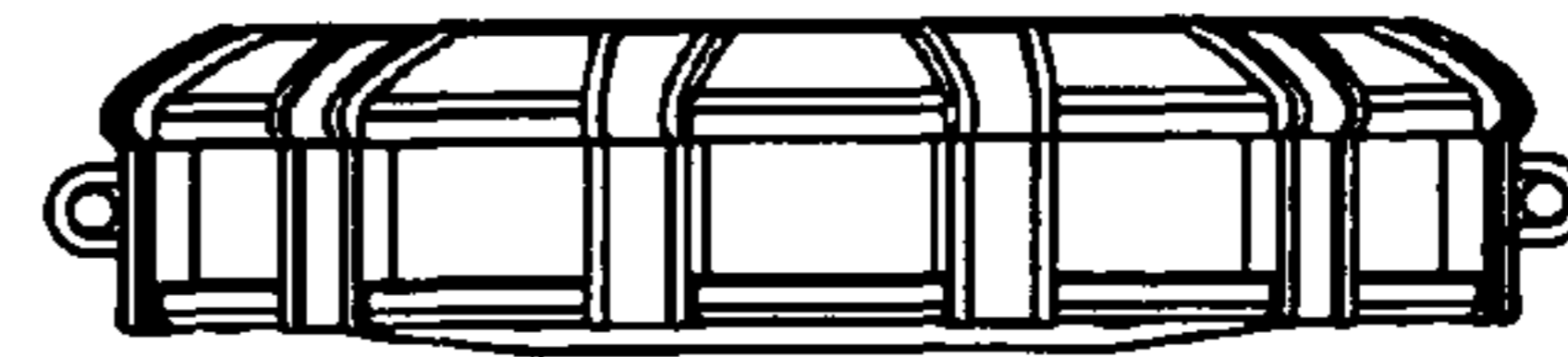

FIG. 5

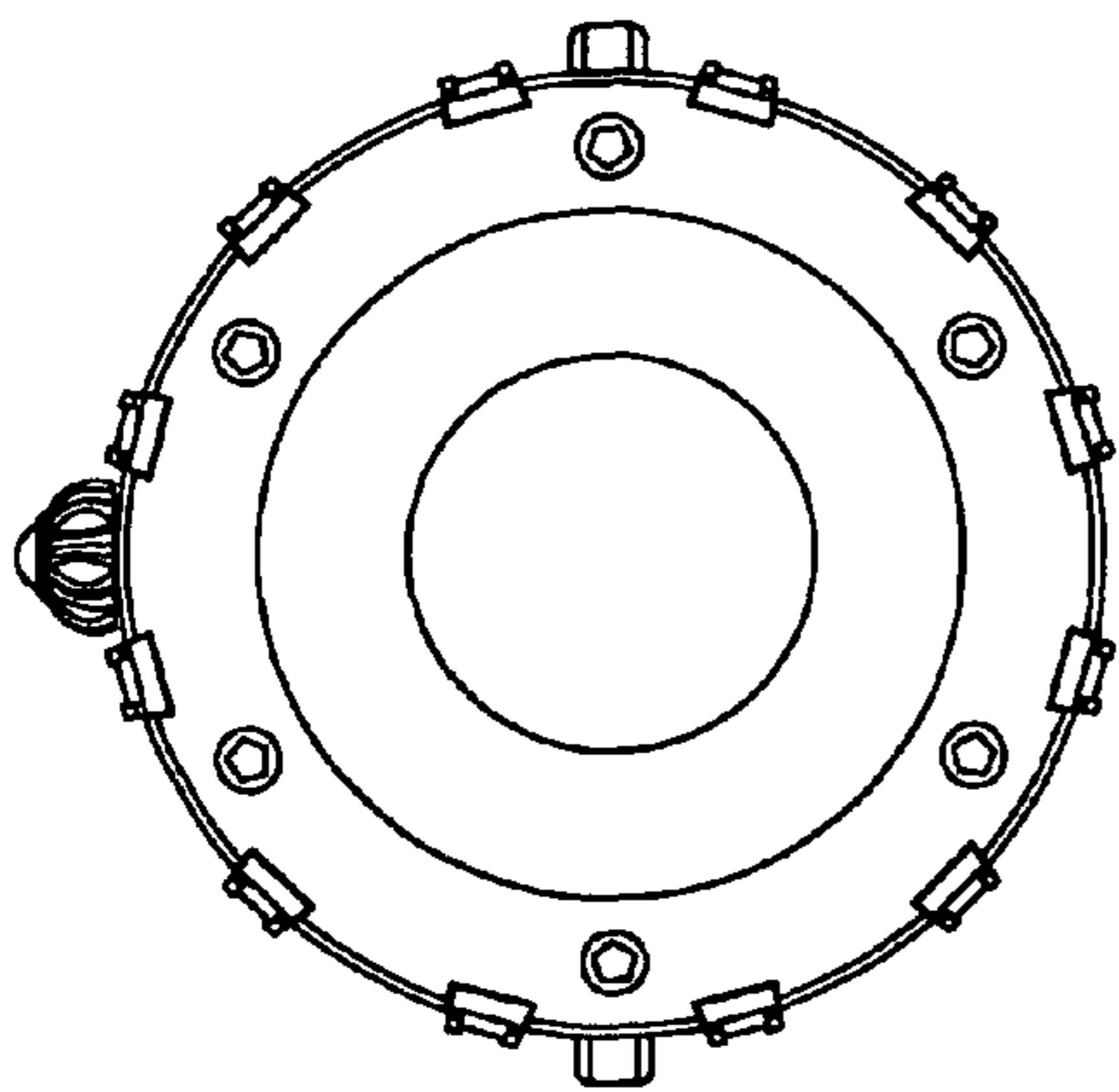

FIG. 2

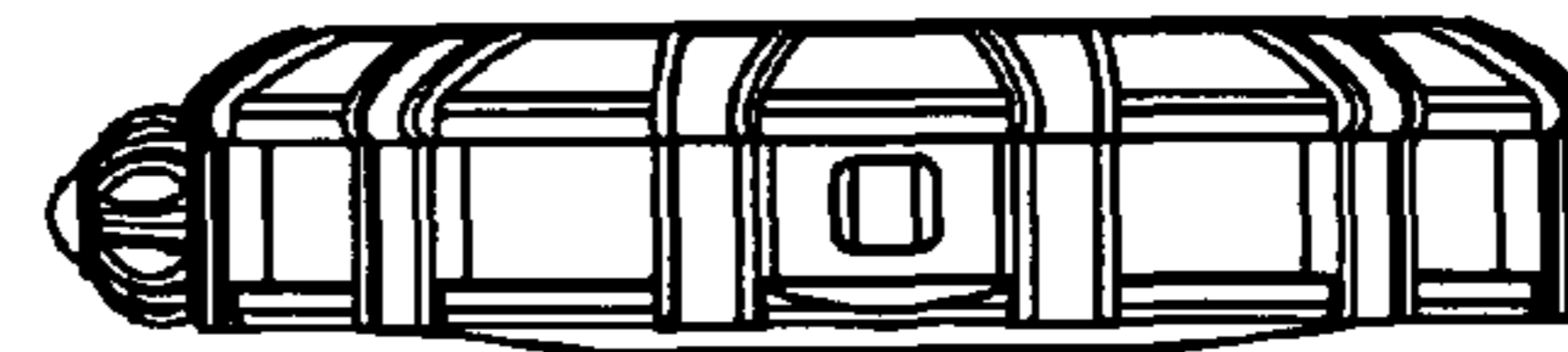

FIG. 6

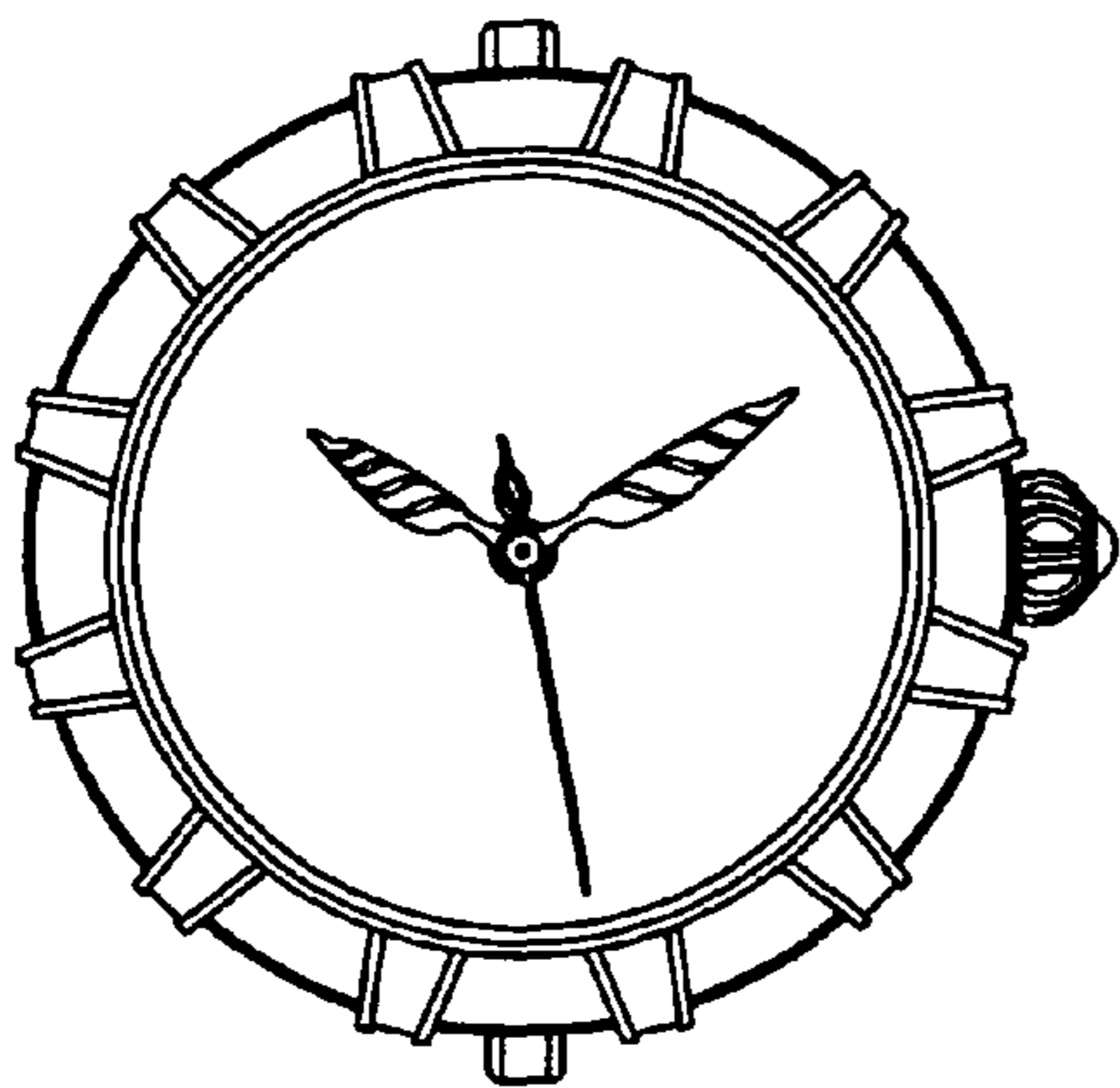

FIG. 3

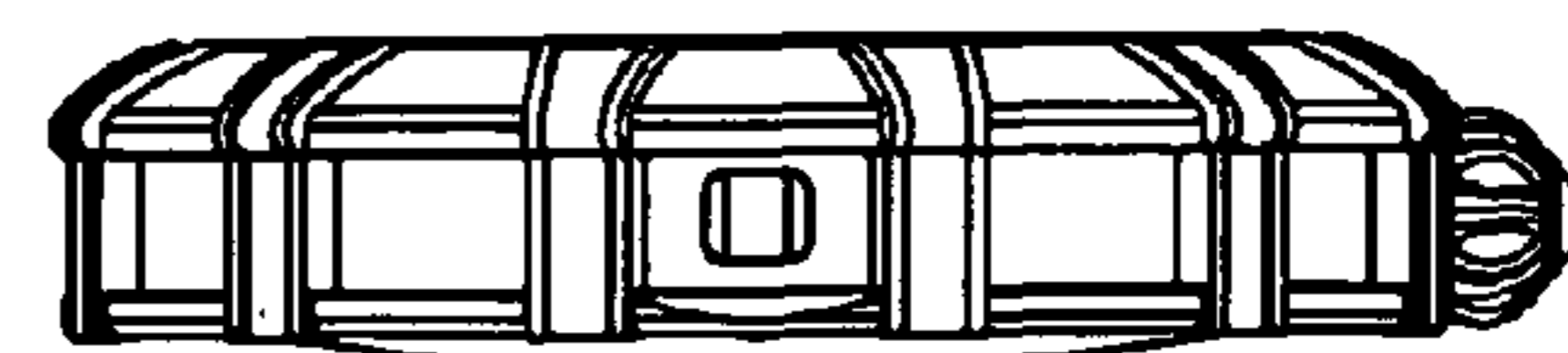

FIG. 7