



US00D643302S

(12) **United States Design Patent**
Stone

(10) **Patent No.:** **US D643,302 S**

(45) **Date of Patent:** **** Aug. 16, 2011**

(54) **BOX WITH LOGO CUTOUT WRAPAROUND CLOSING FLAP**

(75) Inventor: **Carla Lyn Stone**, Ewa Beach, HI (US)

(73) Assignee: **K & S Hawaiian Creations, Incorporated**, Honolulu, HI (US)

(**) Term: **14 Years**

(21) Appl. No.: **29/372,505**

(22) Filed: **Nov. 29, 2010**

(51) **LOC (9) Cl.** **09-01**

(52) **U.S. Cl.** **D9/645; D9/434**

(58) **Field of Classification Search** D3/270-271.1;
D9/600, 643-647, 652, 667, 414, 430-434;
206/457, 458, 527; 220/890; 426/87; D7/628-629
See application file for complete search history.

(56) **References Cited**

U.S. PATENT DOCUMENTS

D180,233 S *	5/1957	Incera	D9/645
D424,882 S *	5/2000	Santiago et al.	D9/645
D427,903 S *	7/2000	Forrest	D9/430
D509,111 S *	9/2005	Vovan	D7/628
D526,572 S *	8/2006	Lemaire	D9/431
D560,507 S *	1/2008	Lepoitevin	D9/645
D593,418 S *	6/2009	Lo et al.	D9/645

* cited by examiner

Primary Examiner — Sandra Morris

(74) *Attorney, Agent, or Firm* — Martin E. Hsia

(57) **CLAIM**

The ornamental design for a box with logo cutout wraparound closing flap, as shown and described.

DESCRIPTION

FIG. 1 is a perspective view from the front, left, top of a first embodiment of the box with logo cutout wraparound closing flap of my new design in the closed position;

FIG. 2 is a front view thereof;

FIG. 3 is a rear view thereof;

FIG. 4 is a side view thereof from the right;

FIG. 5 is a side view thereof from the left;

FIG. 6 is a top end view thereof;

FIG. 7 is a bottom end view thereof;

FIG. 8 is a perspective view from the front, left, top thereof in the partially opened position;

FIG. 9 is a front view thereof;

FIG. 10 is a rear view thereof;

FIG. 11 is a side view thereof from the right;

FIG. 12 is a side view thereof from the left;

FIG. 13 is a top end view thereof;

FIG. 14 is a bottom end view thereof;

FIG. 15 is a perspective view from the front, left top of a second embodiment of the box with logo cutout wraparound closing flap of my new design in the closed position;

FIG. 16 is a front view thereof;

FIG. 17 a rear view thereof;

FIG. 18 is a side view thereof from the right;

FIG. 19 is a side view thereof from the left;

FIG. 20 is a top end view thereof; and,

FIG. 21 is a bottom end view thereof.

The broken lines in the figures show environmental structure and form no part of the claimed design thereof.

1 Claim, 18 Drawing Sheets

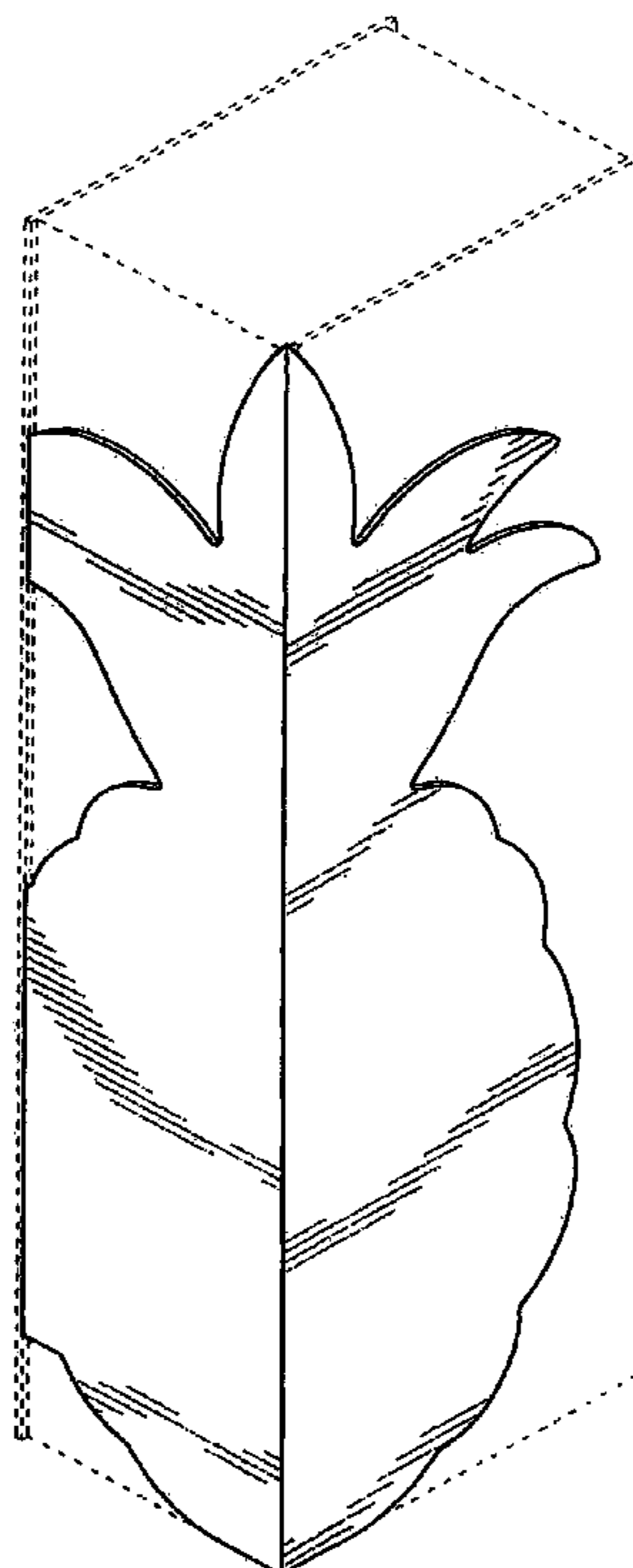

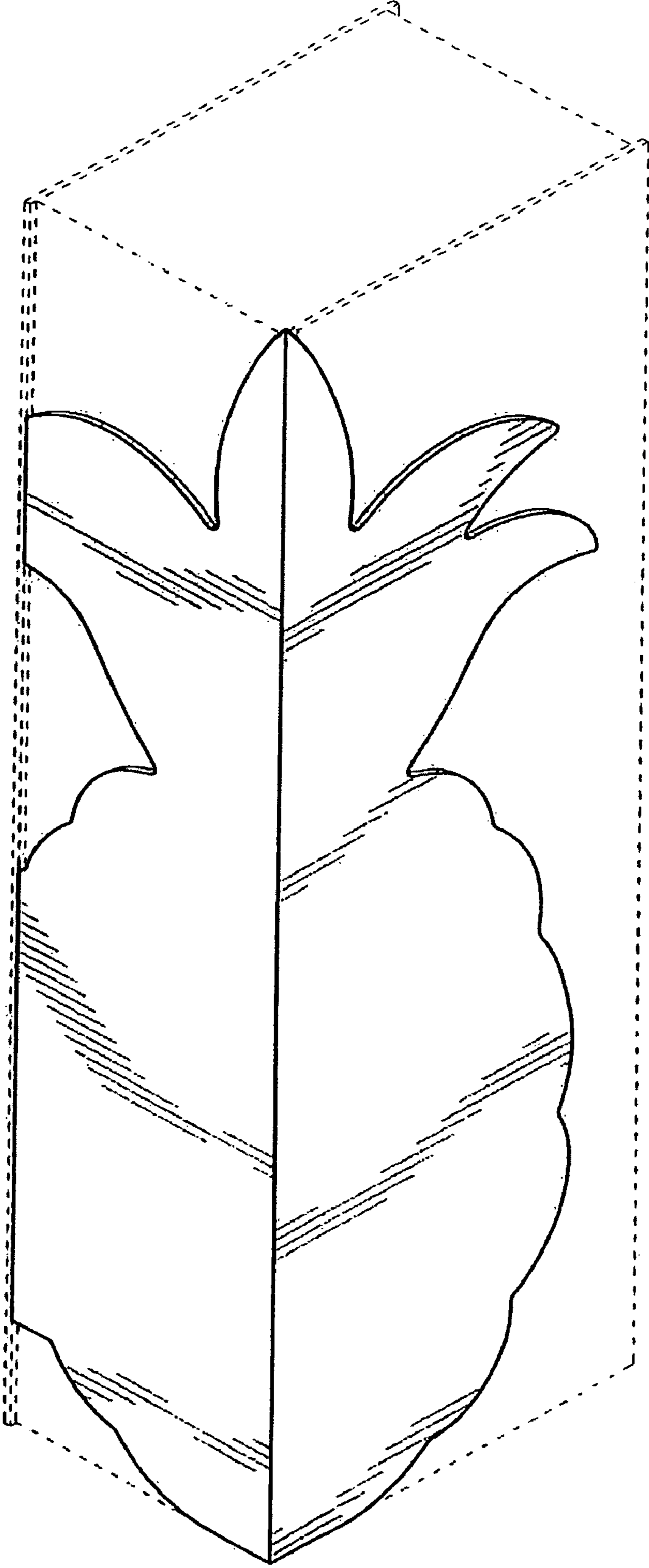

FIG. 1

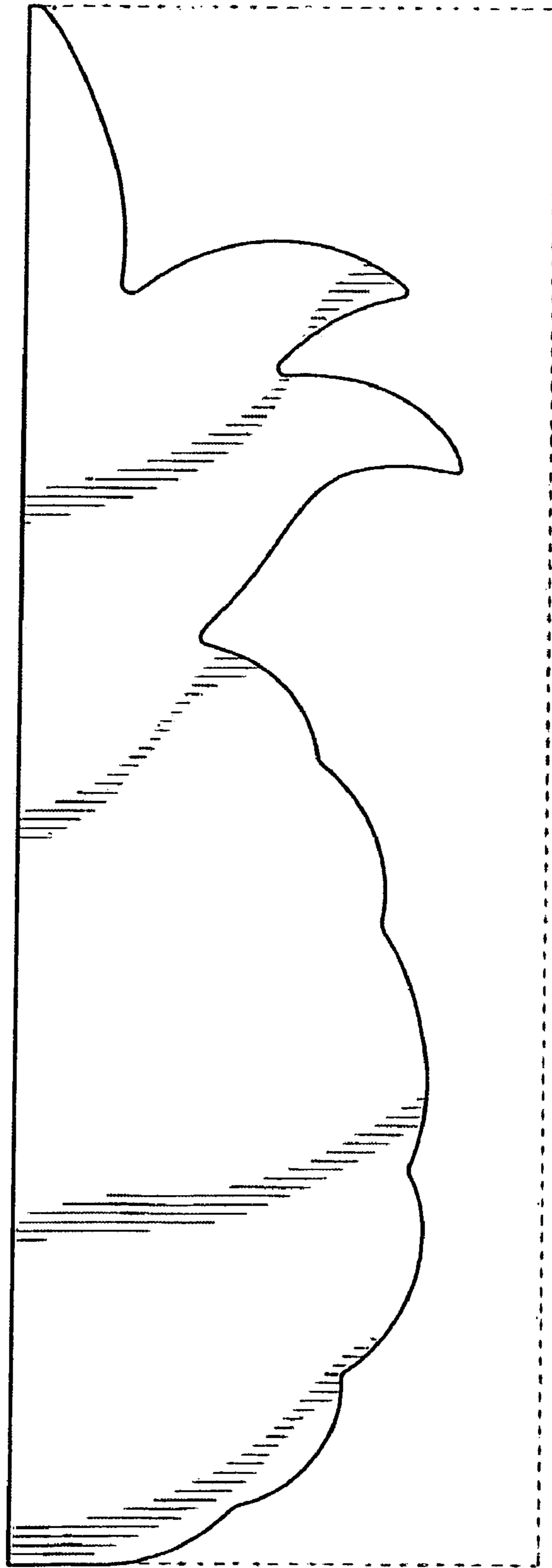

FIG. 2

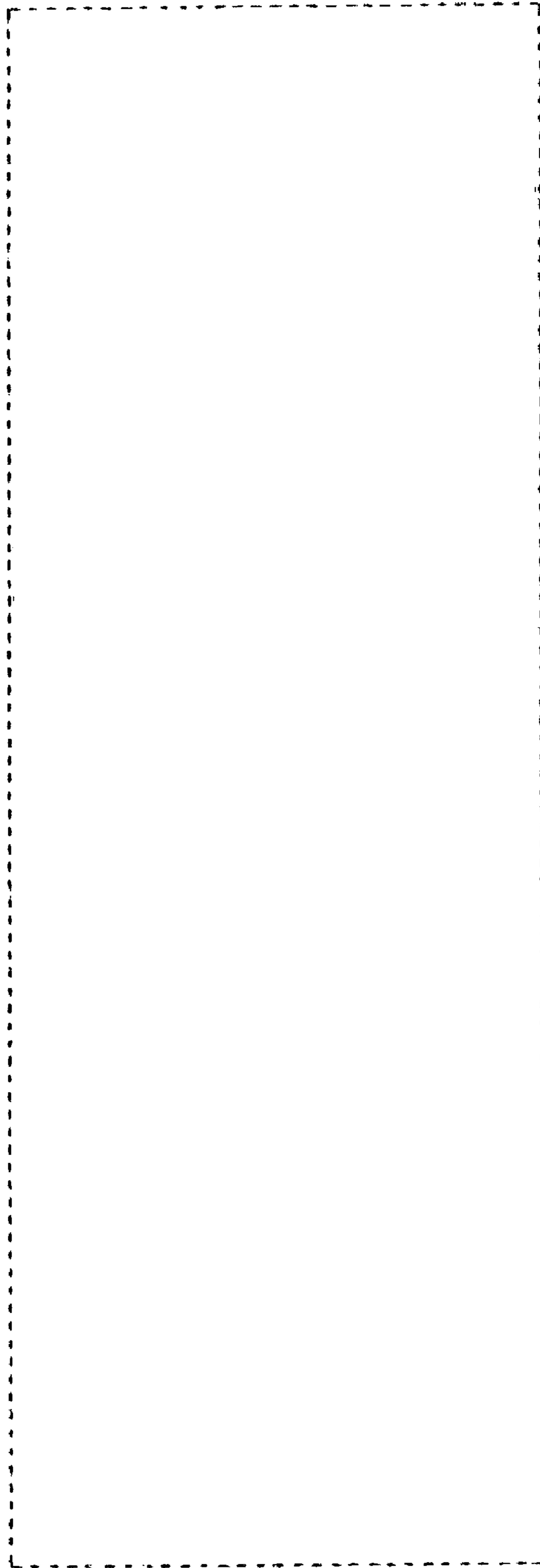

FIG. 3

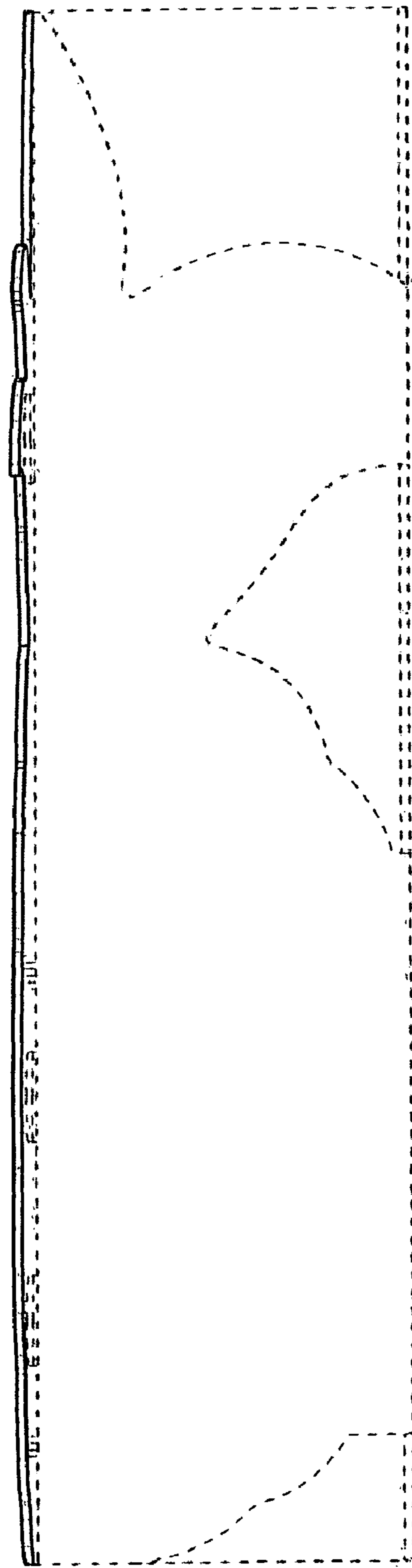

FIG. 4

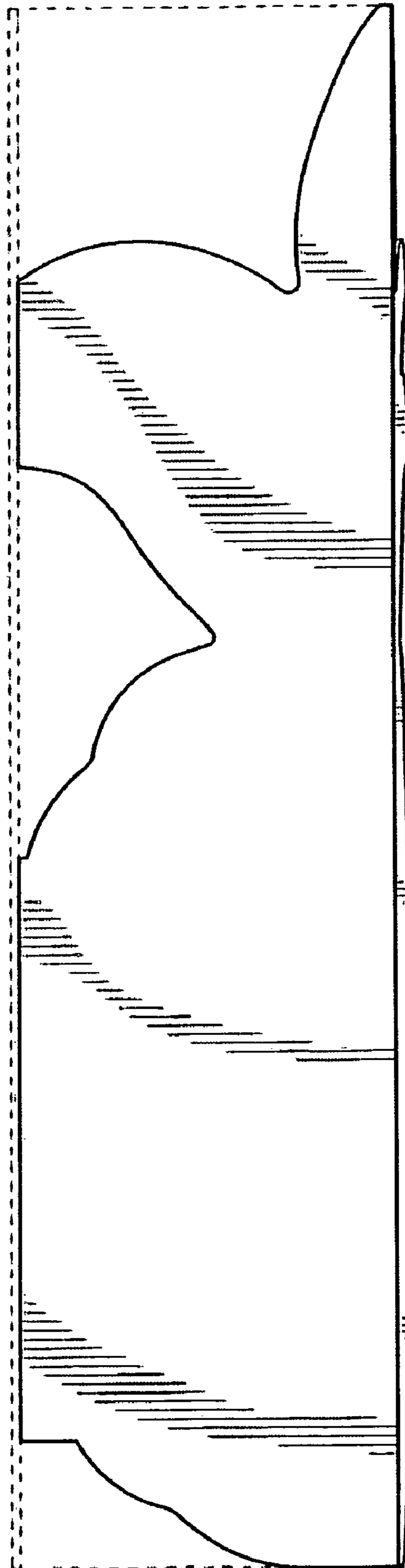

FIG. 5

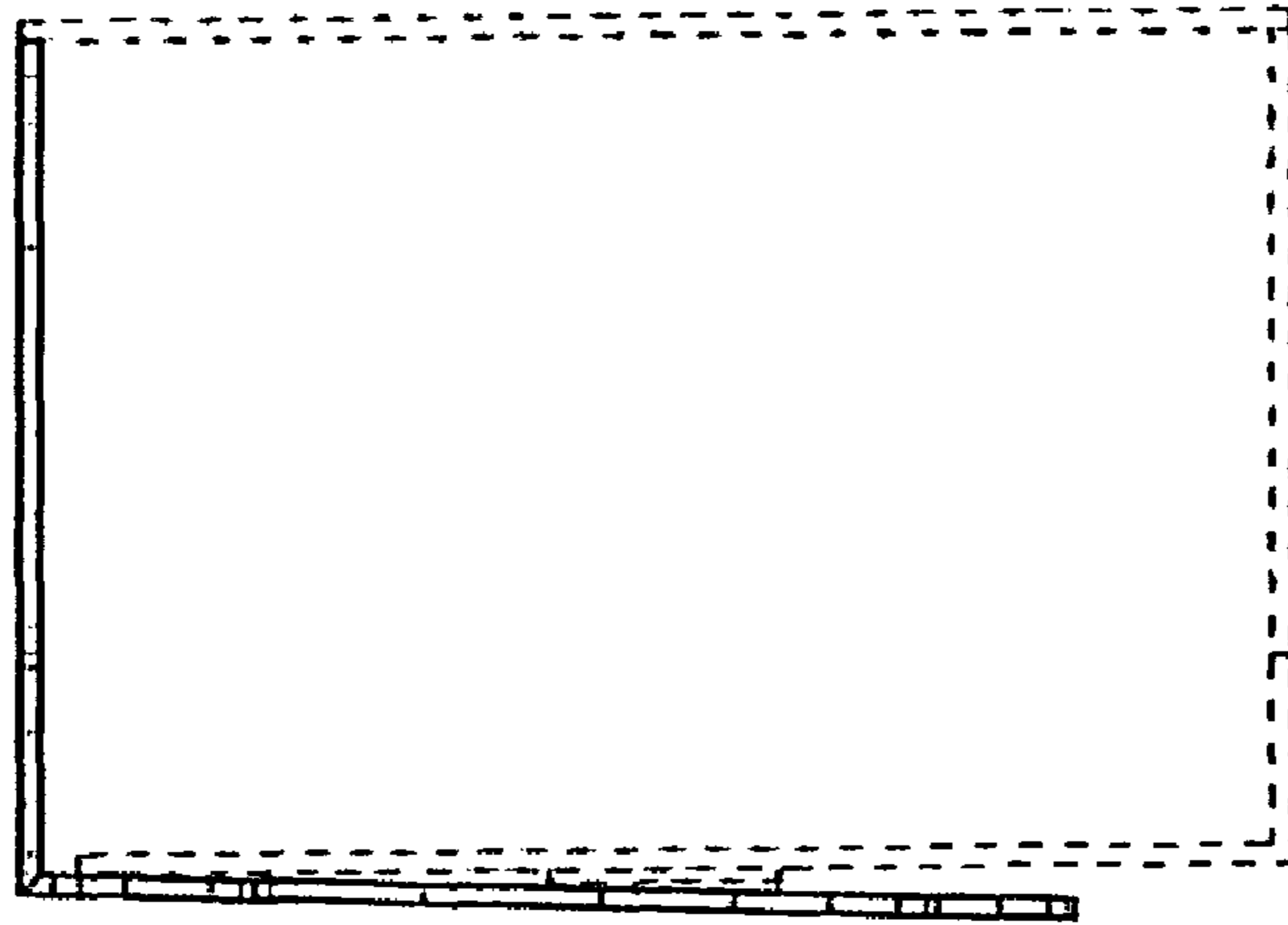

FIG. 6

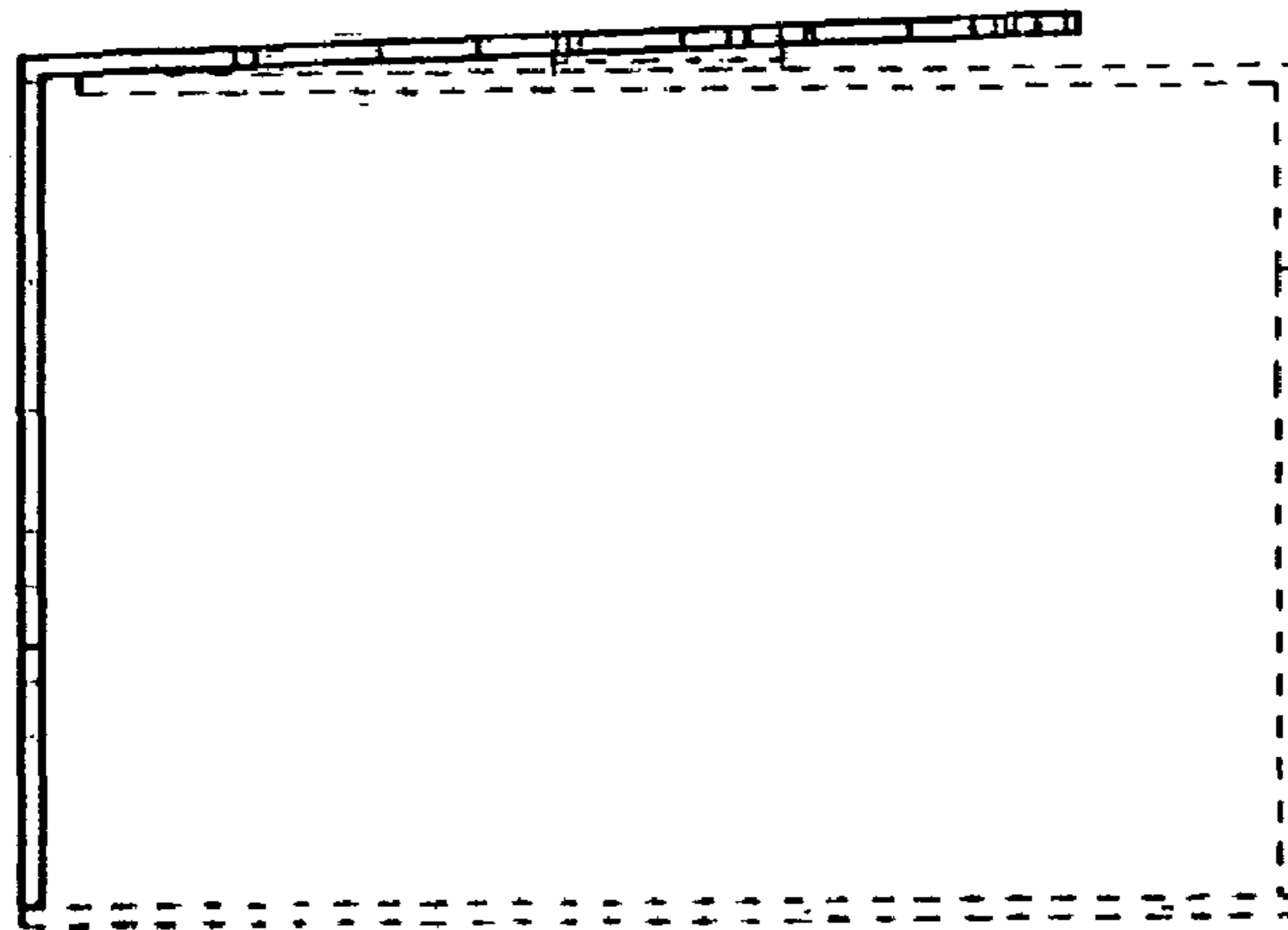

FIG. 7

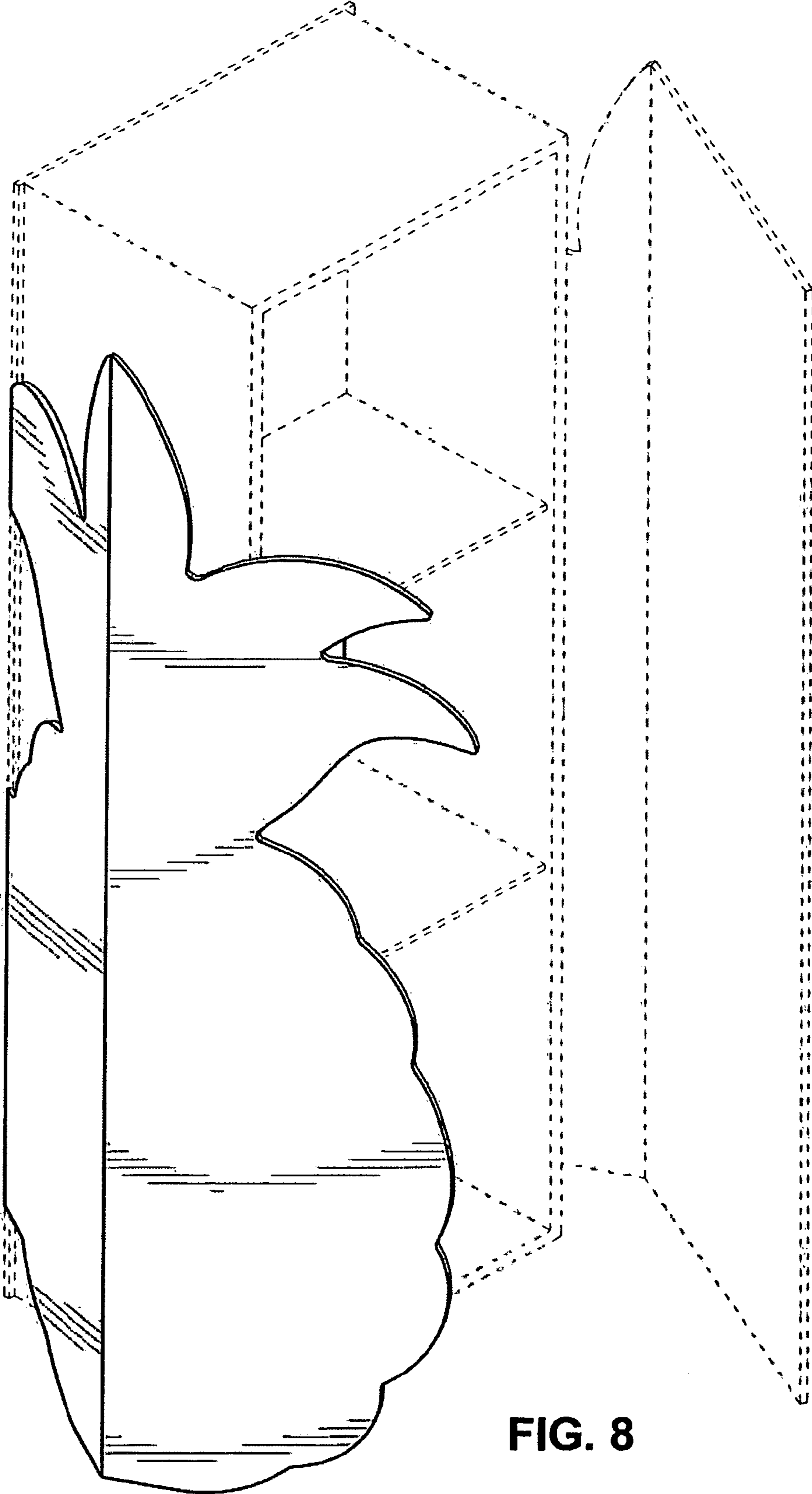

FIG. 8

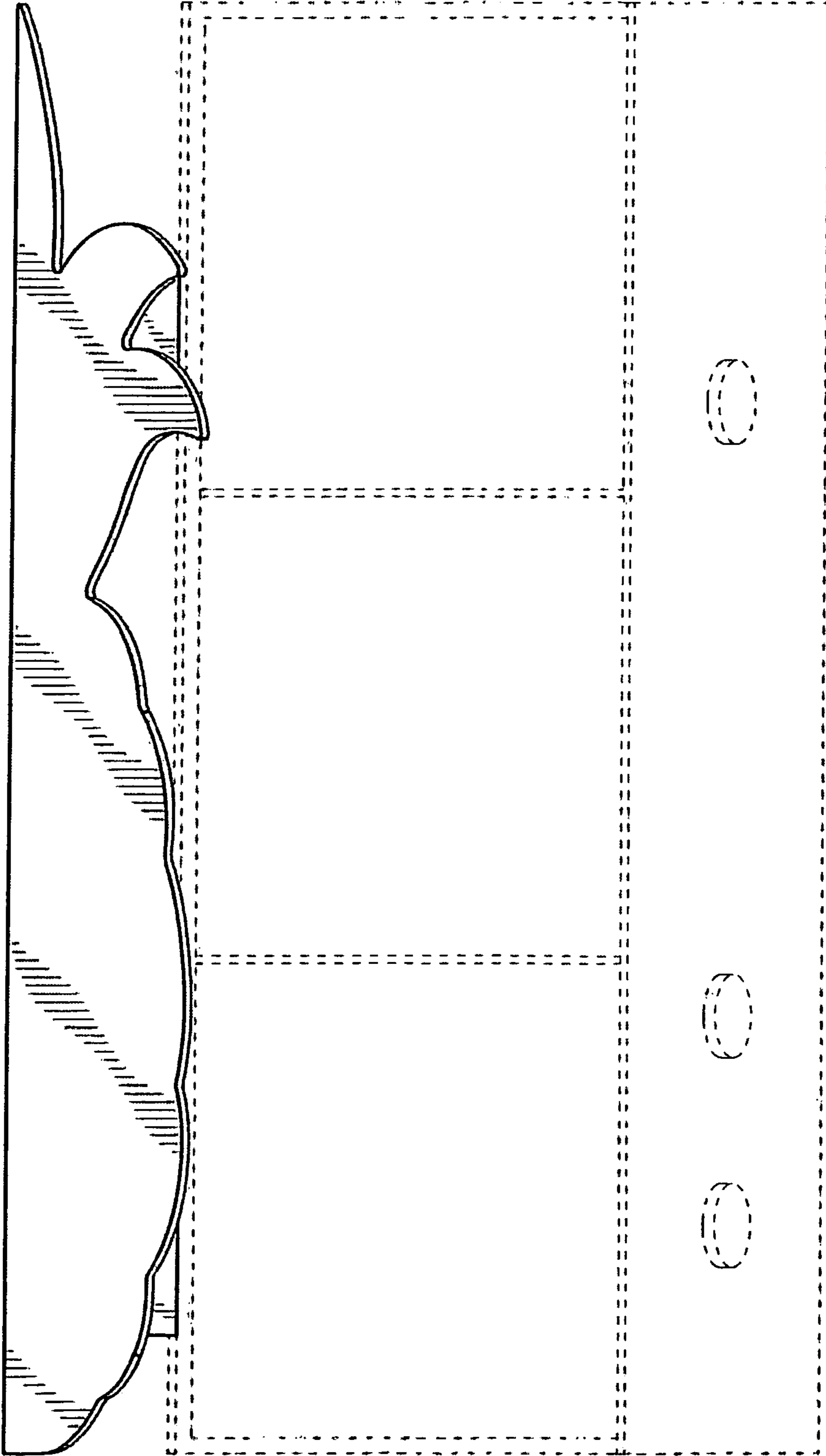

FIG. 9

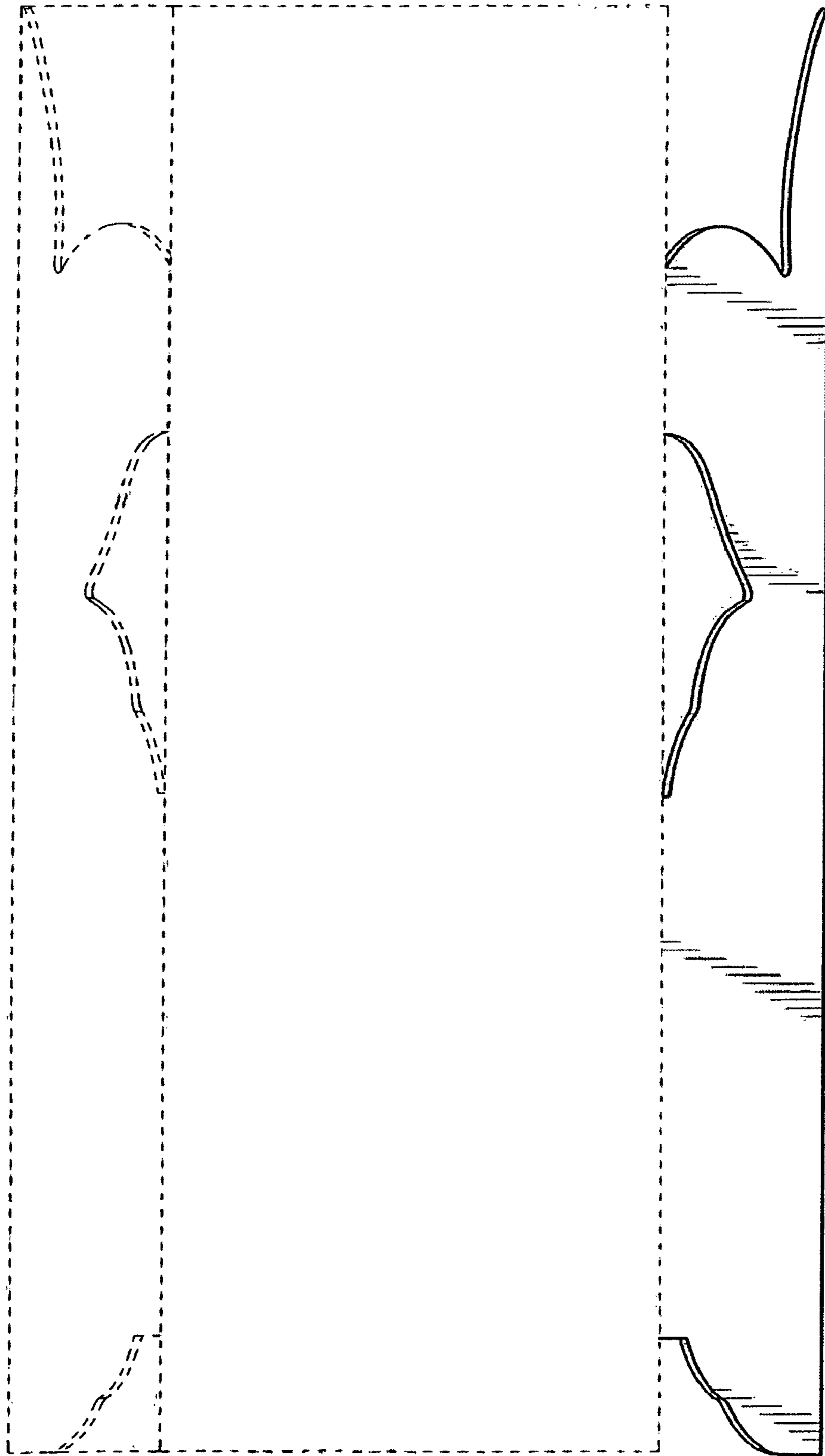

FIG. 10

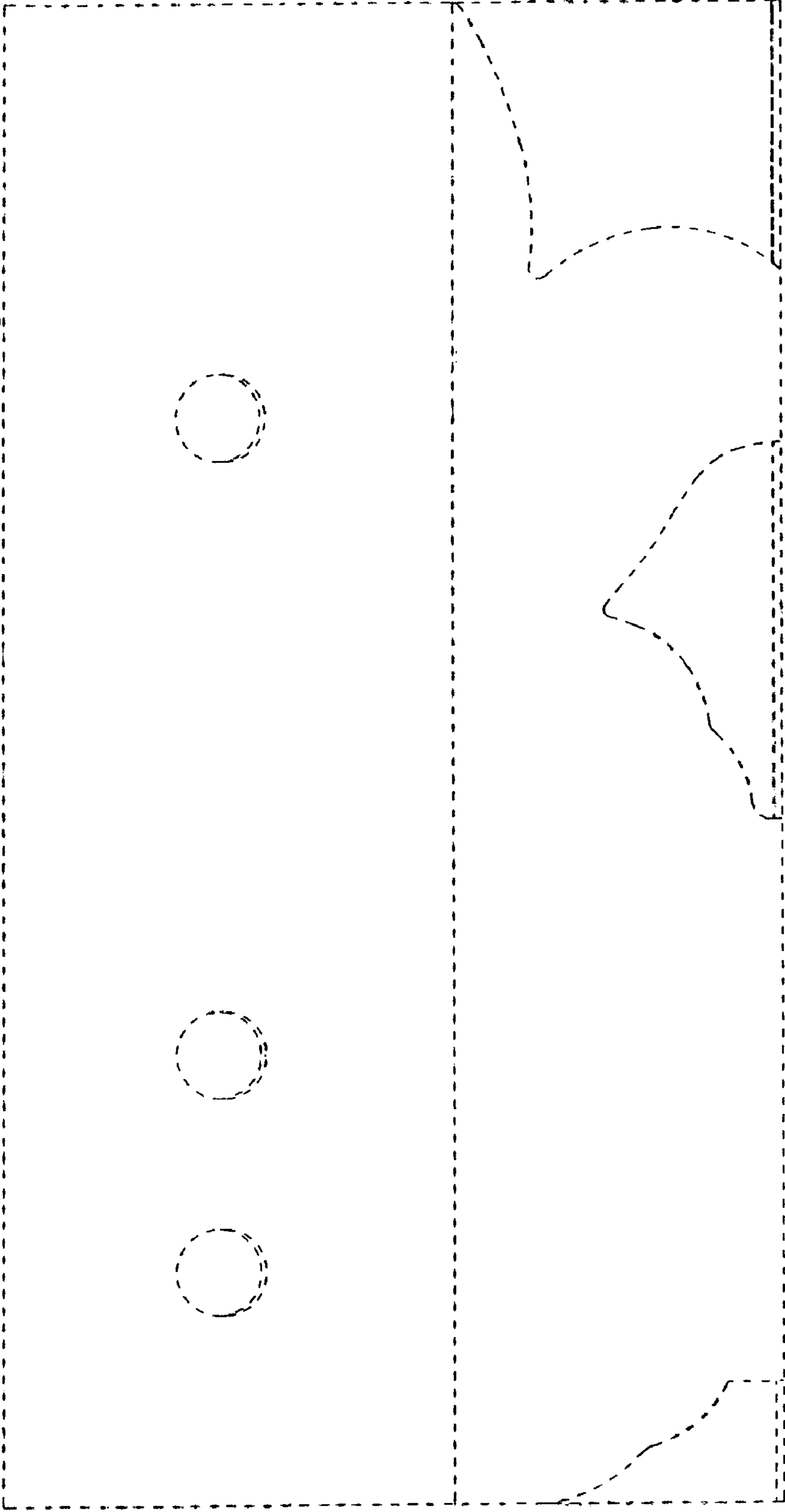

FIG. 11

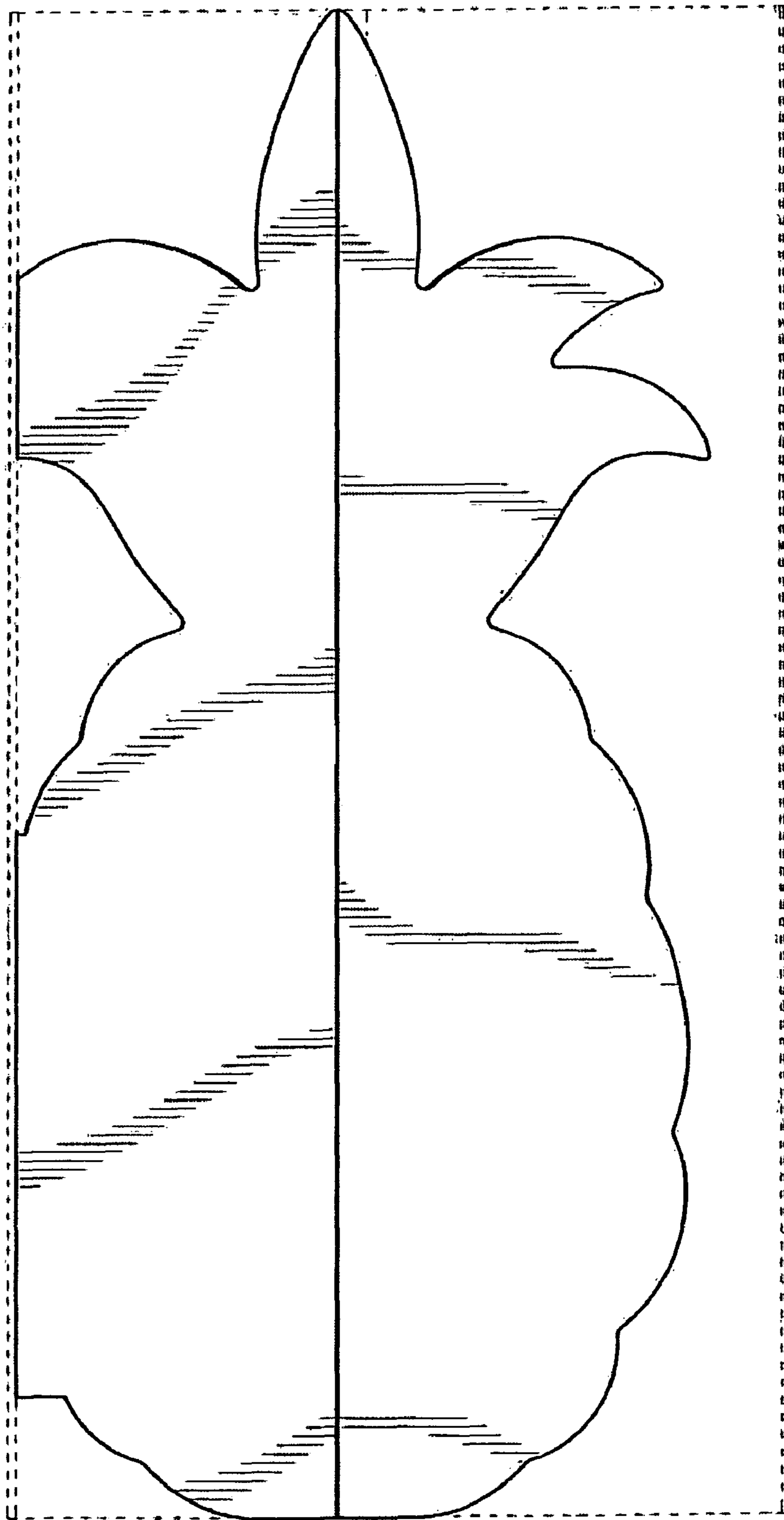

FIG. 12

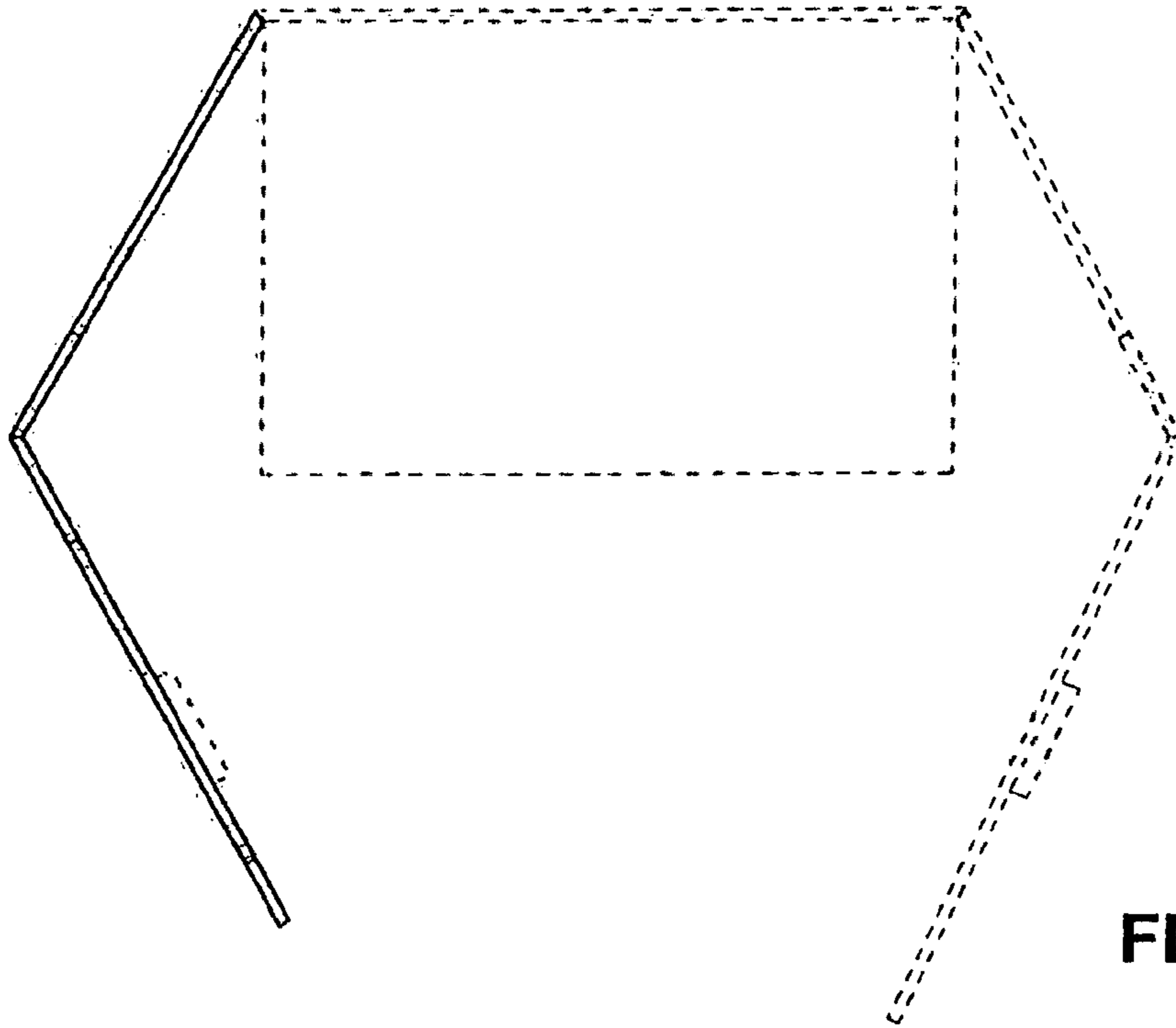

FIG. 13

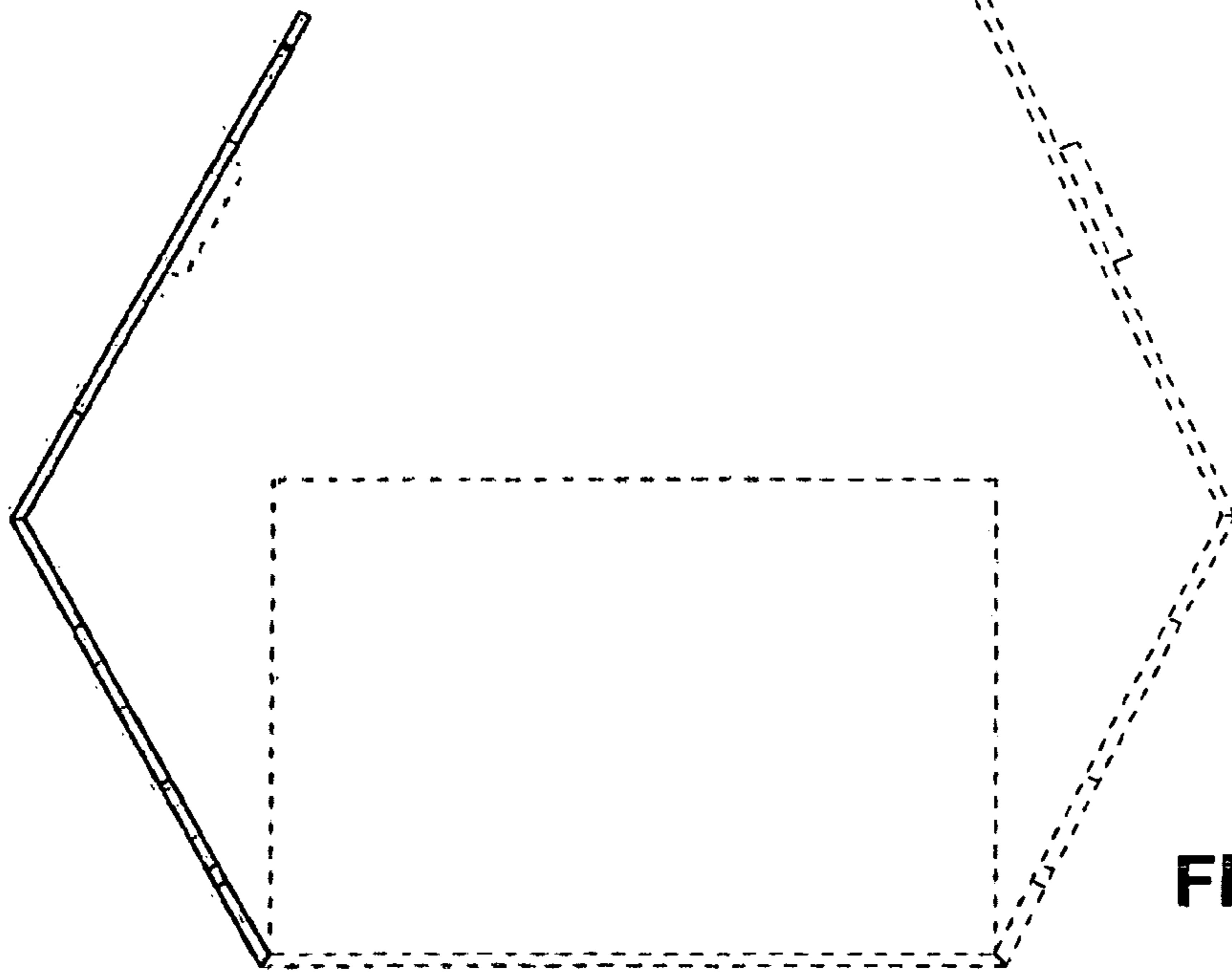

FIG. 14

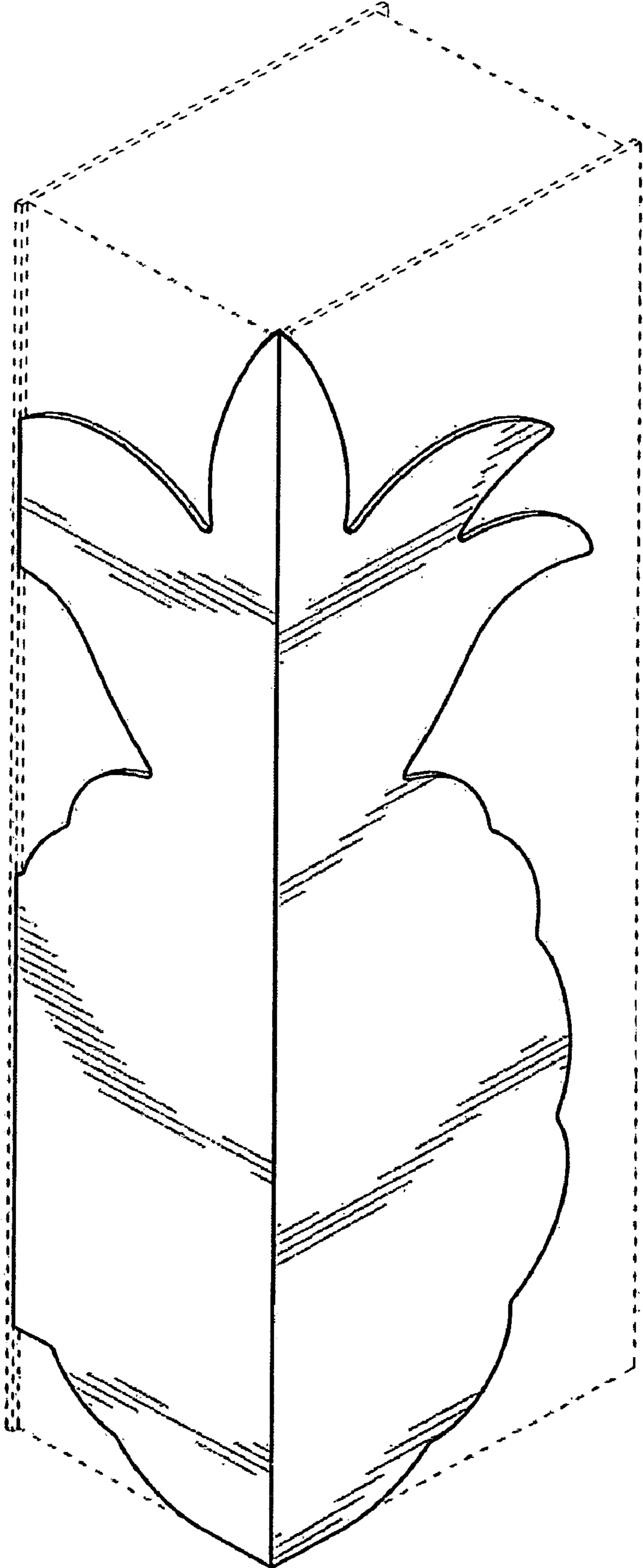

FIG. 15

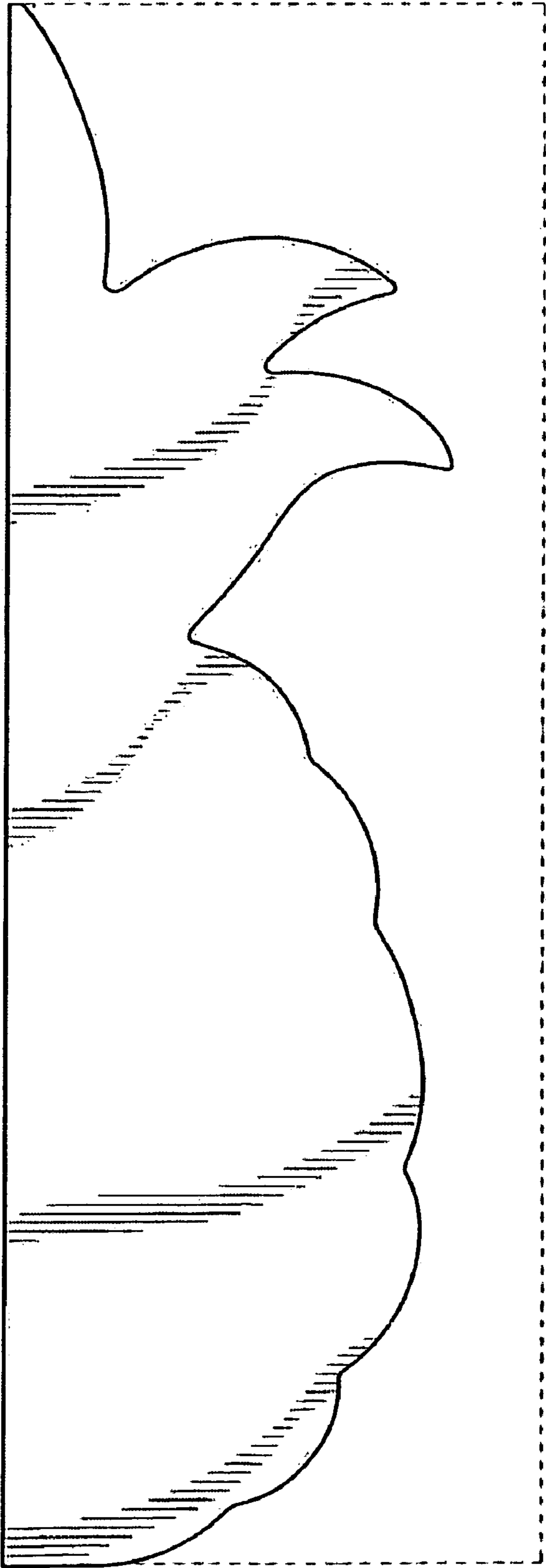

FIG. 16

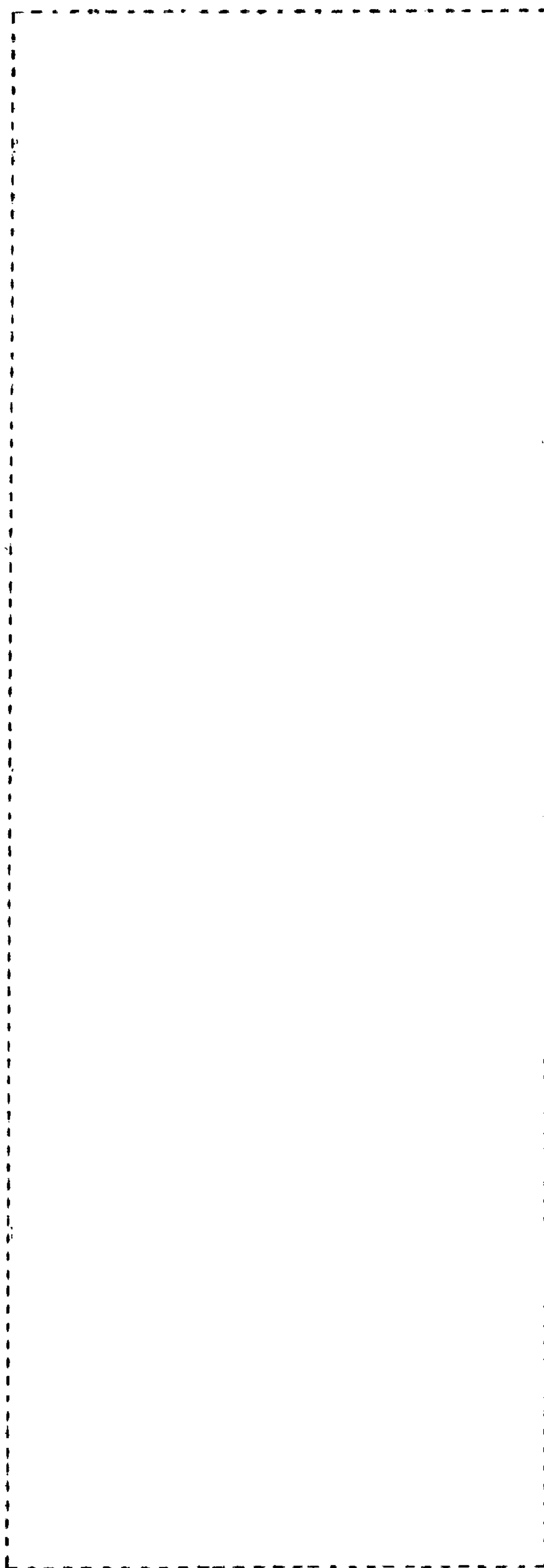

FIG. 17

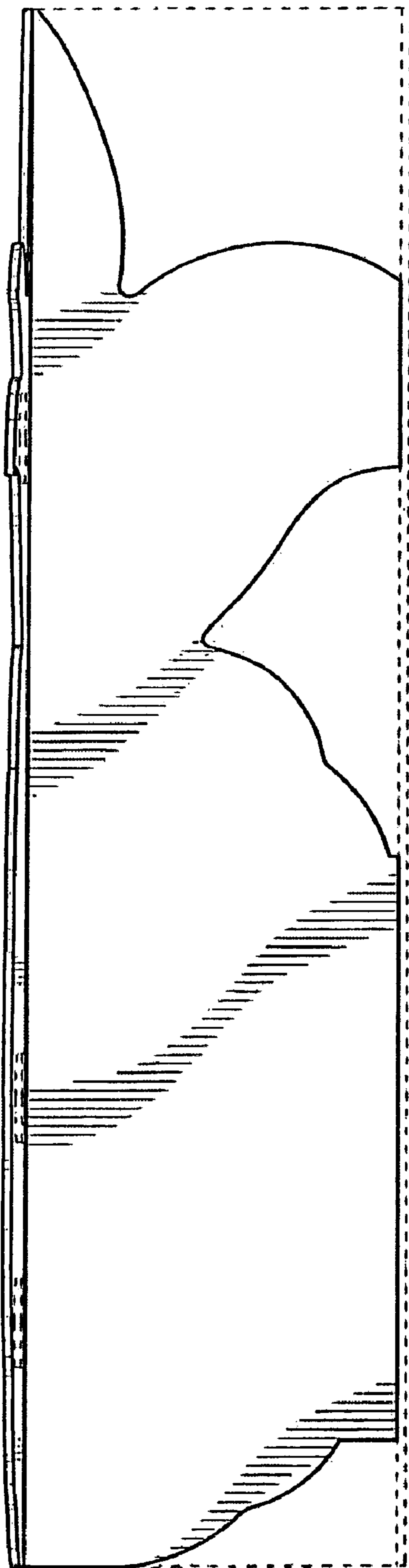

FIG. 18

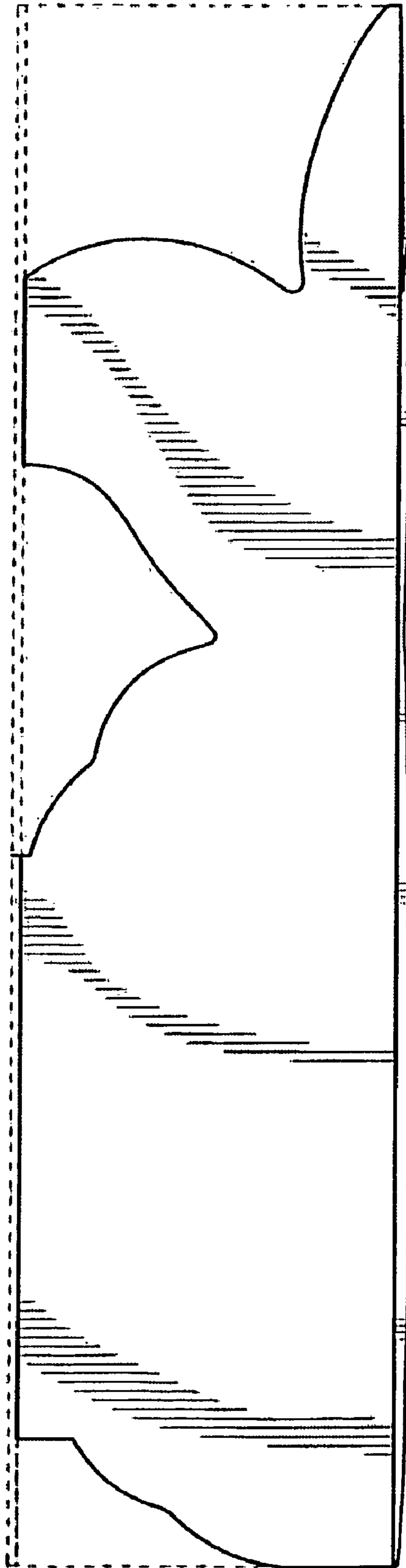

FIG.19

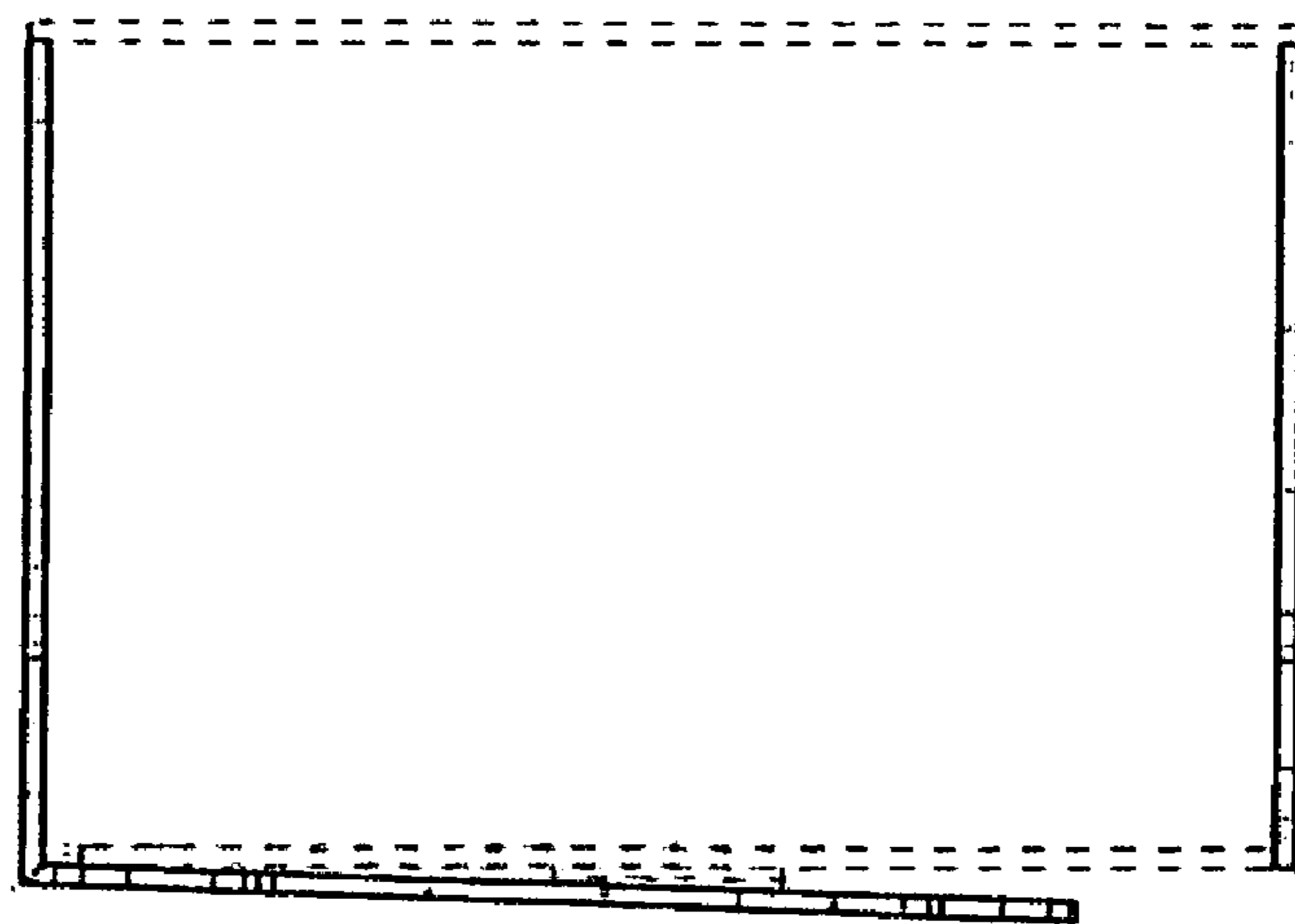

FIG. 20

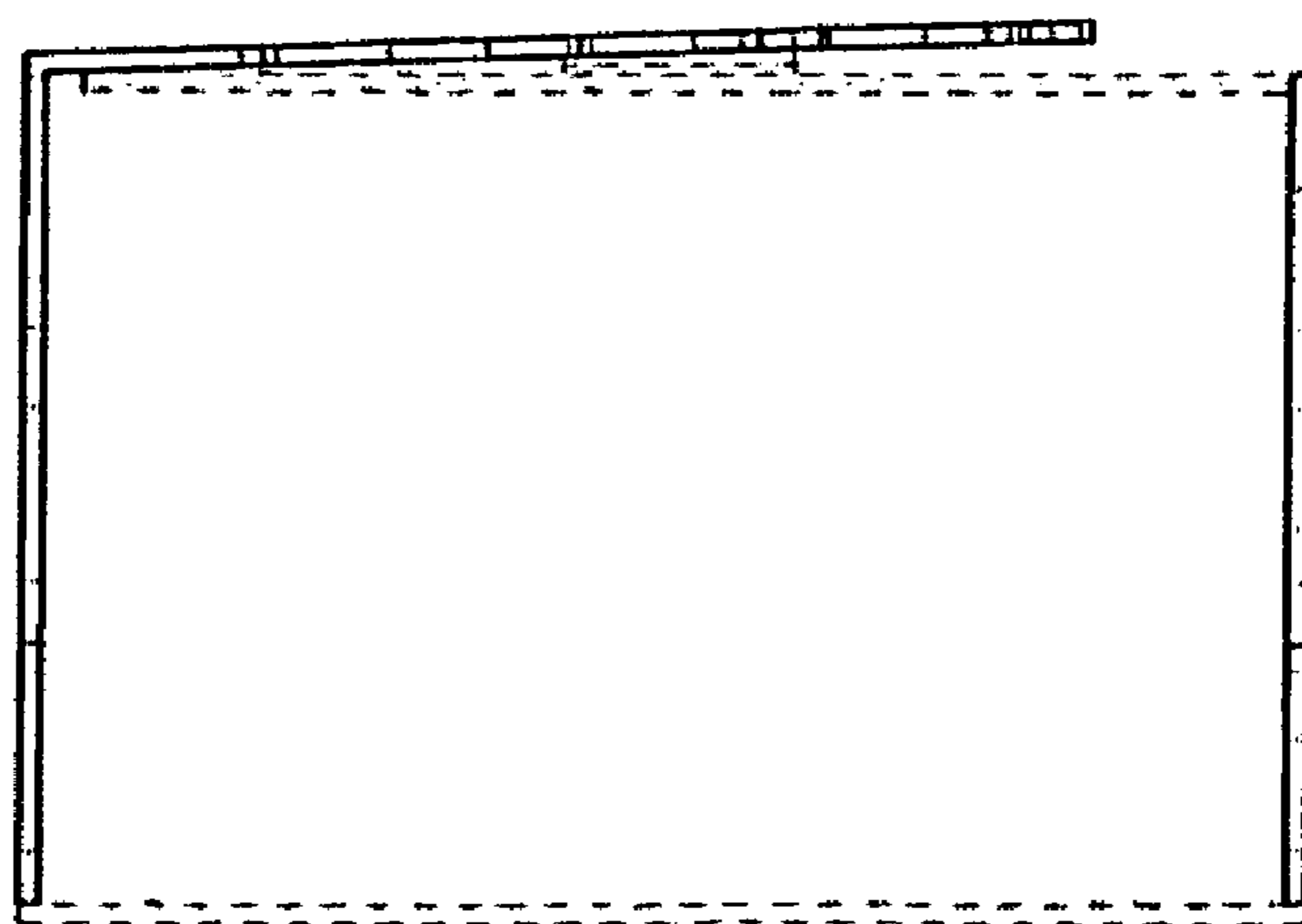

FIG. 21