



US00D643228S

(12) **United States Design Patent**
Strempack

(10) **Patent No.:** **US D643,228 S**

(45) **Date of Patent:** **** Aug. 16, 2011**

(54) **DIGITAL DISPLAY STAND**

(75) Inventor: **Guy Thomas Strempack**, Fort
Lauderdale, FL (US)

(73) Assignee: **First American Advertising**
Corporation, Fort Lauderdale, FL (US)

(**) Term: **14 Years**

(21) Appl. No.: **29/378,532**

(22) Filed: **Nov. 5, 2010**

(51) **LOC (9) Cl.** **06-04**

(52) **U.S. Cl.** **D6/397; D6/468**

(58) **Field of Classification Search** D6/475,
D6/630, 476, 396, 499, 150, 453-469, 471,
D6/473, 474, 477, 479; 211/1, 13.1, 42,
211/43, 49.1, 50, 52, 53, 55, 56, 58, 60.1,
211/70.3, 85.2, 85.8, 189; 40/124, 124.2,
40/124.4

See application file for complete search history.

(56) **References Cited**

U.S. PATENT DOCUMENTS

D340,156 S * 10/1993 Bonazza et al. D6/476
D463,191 S * 9/2002 Palmer et al. D6/630

D532,218 S * 11/2006 Caldwell et al. D6/468
D532,219 S * 11/2006 Sandler et al. D6/475
D536,552 S * 2/2007 Dickerson et al. D6/468
D572,942 S * 7/2008 Robbins et al. D6/468
D635,377 S * 4/2011 Rodgers et al. D6/468

* cited by examiner

Primary Examiner — Philip S Hyder

Assistant Examiner — Sydney Buffalow

(74) *Attorney, Agent, or Firm* — Sinorica, LLC

(57) **CLAIM**

The ornamental design for a digital display stand, as shown and described.

DESCRIPTION

FIG. 1 is a perspective view of a digital display stand;
FIG. 2 is a front elevational view thereof;
FIG. 3 is a rear elevational view thereof;
FIG. 4 is a right-side elevational view thereof;
FIG. 5 is a left-side elevational view thereof;
FIG. 6 is a bottom plan view thereof; and,
FIG. 7 is a top plan view thereof.

The broken line showing of a digital display stand is for the purpose of illustrating environmental structure and forms no part of the claimed design.

1 Claim, 5 Drawing Sheets

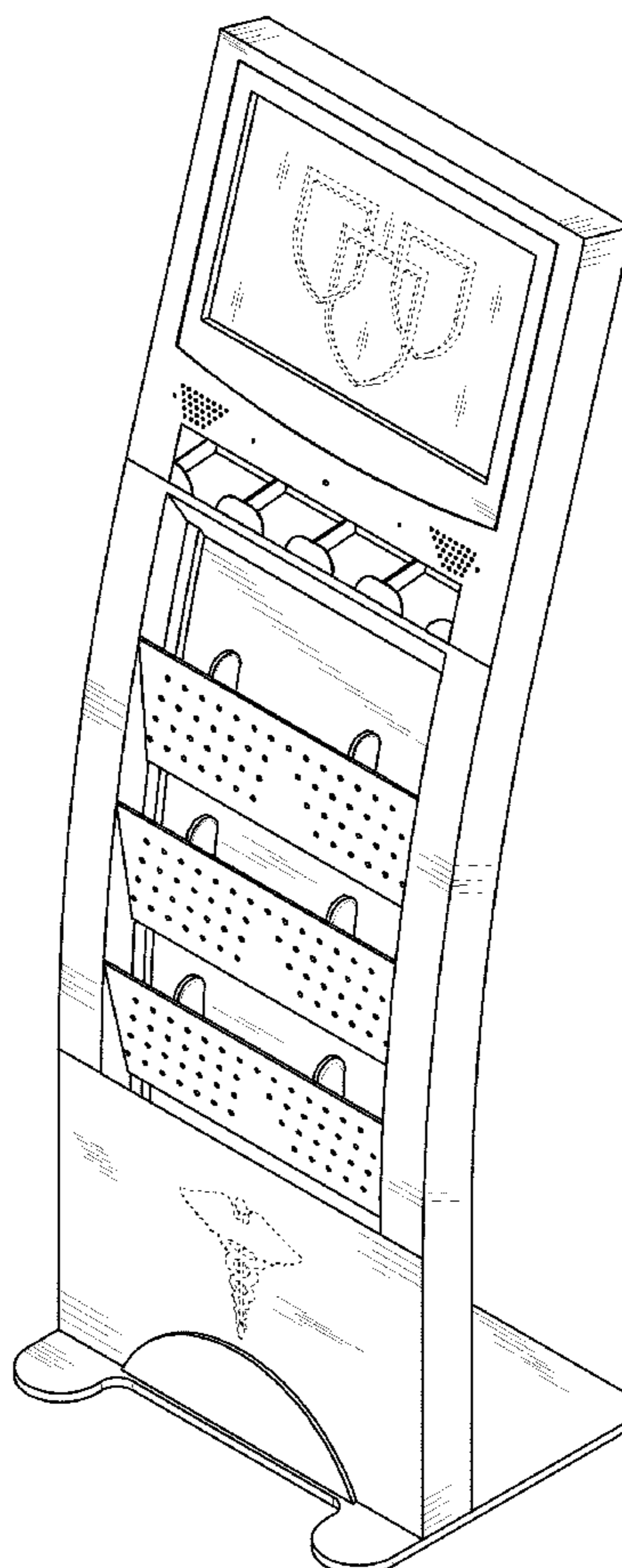

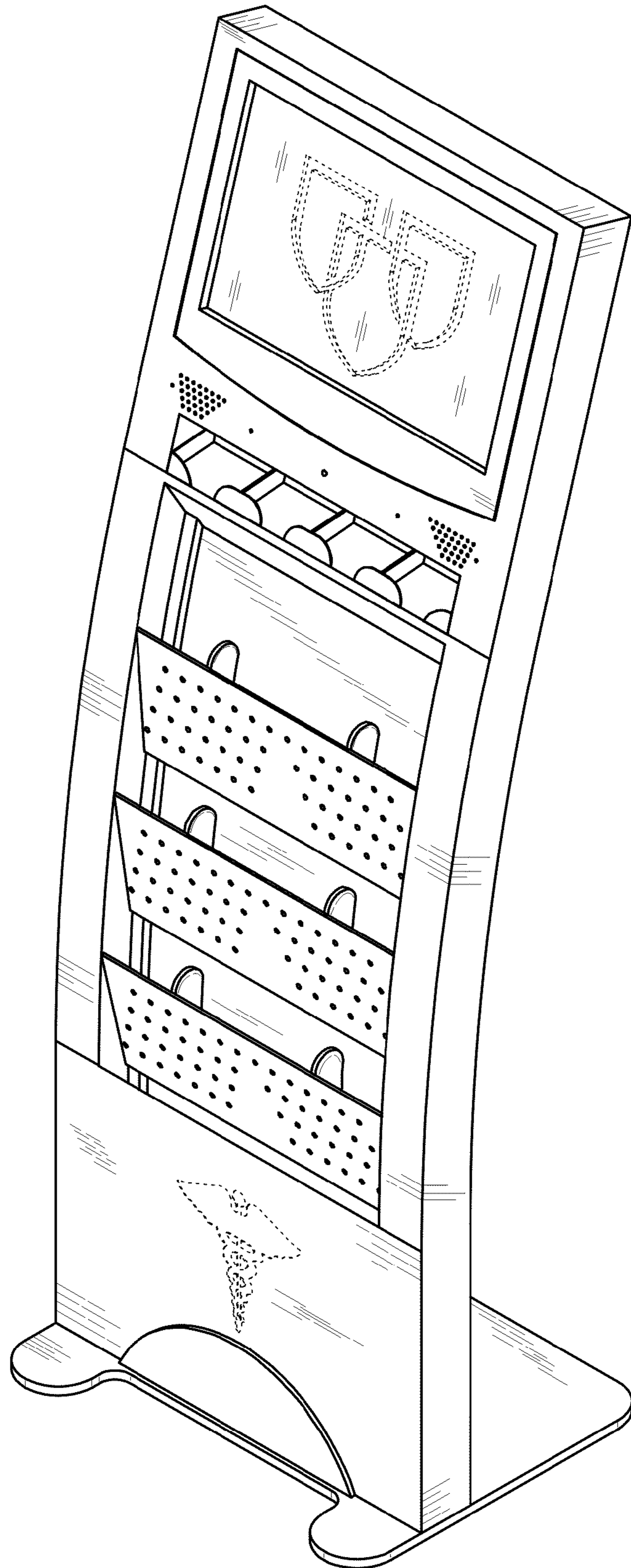

FIG. 1

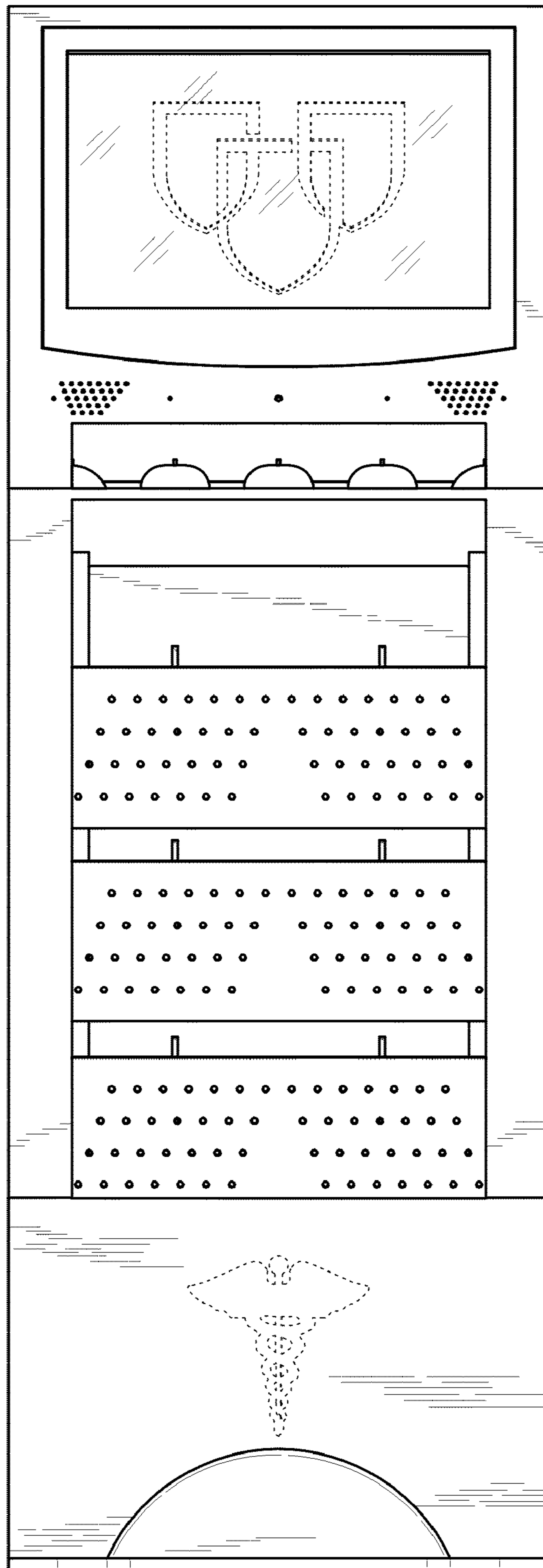

FIG. 2



FIG. 3

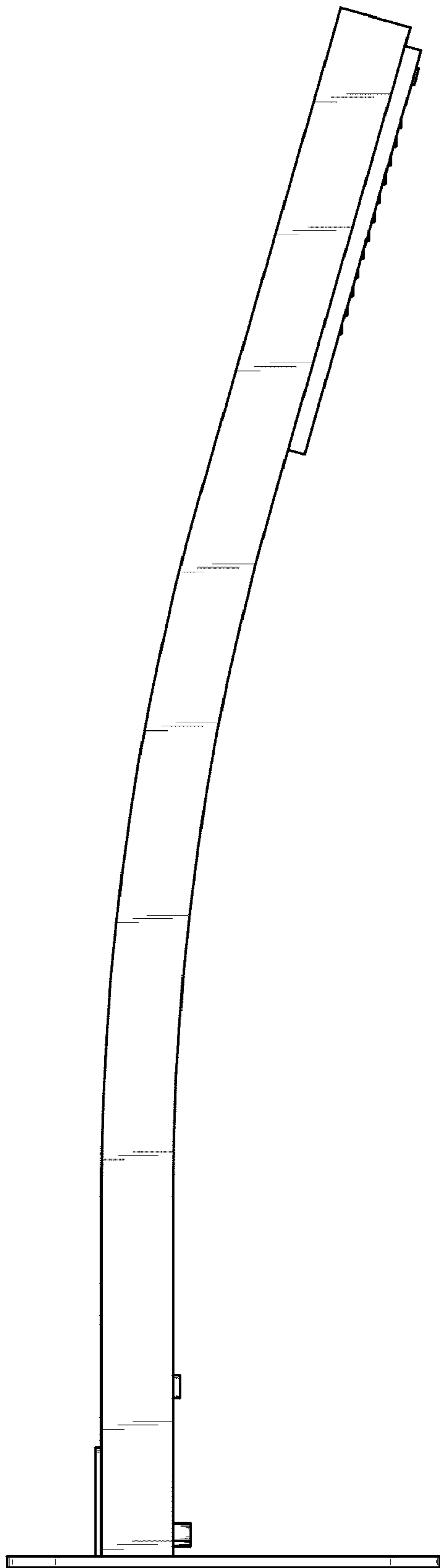

FIG. 4

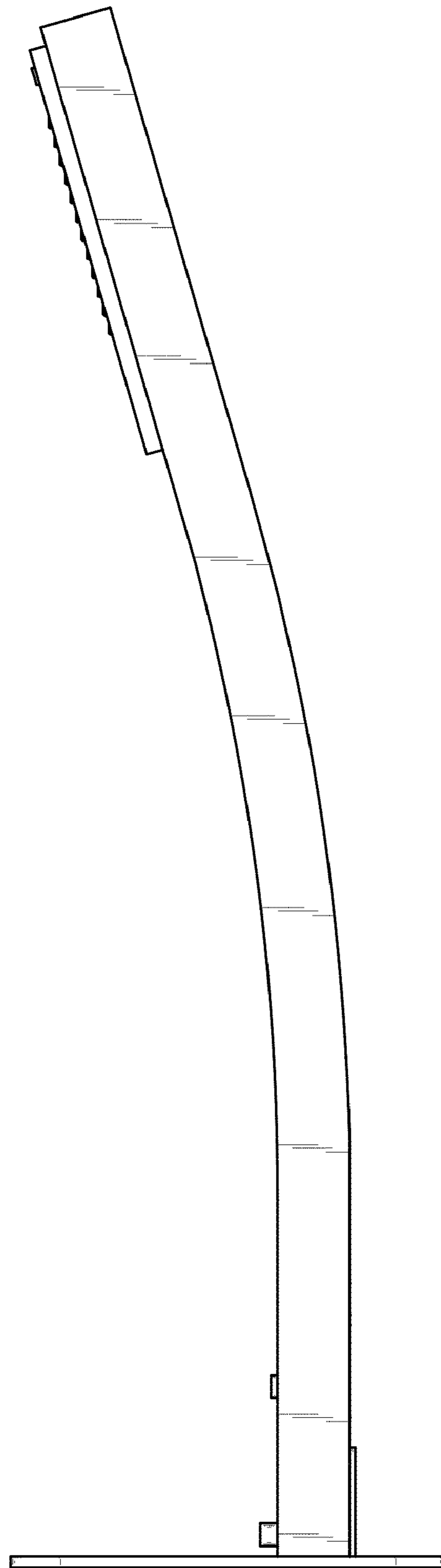

FIG. 5

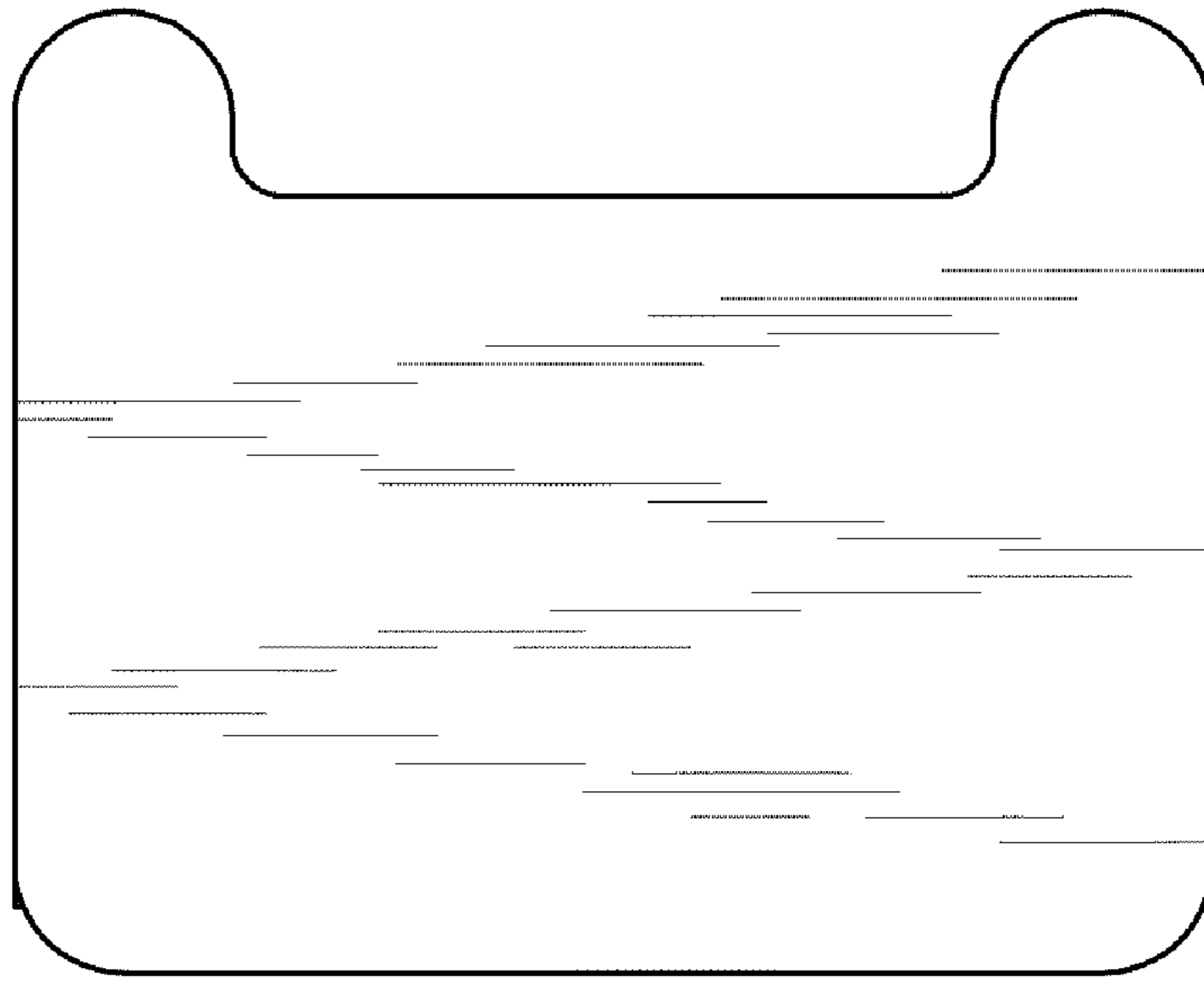

FIG. 6

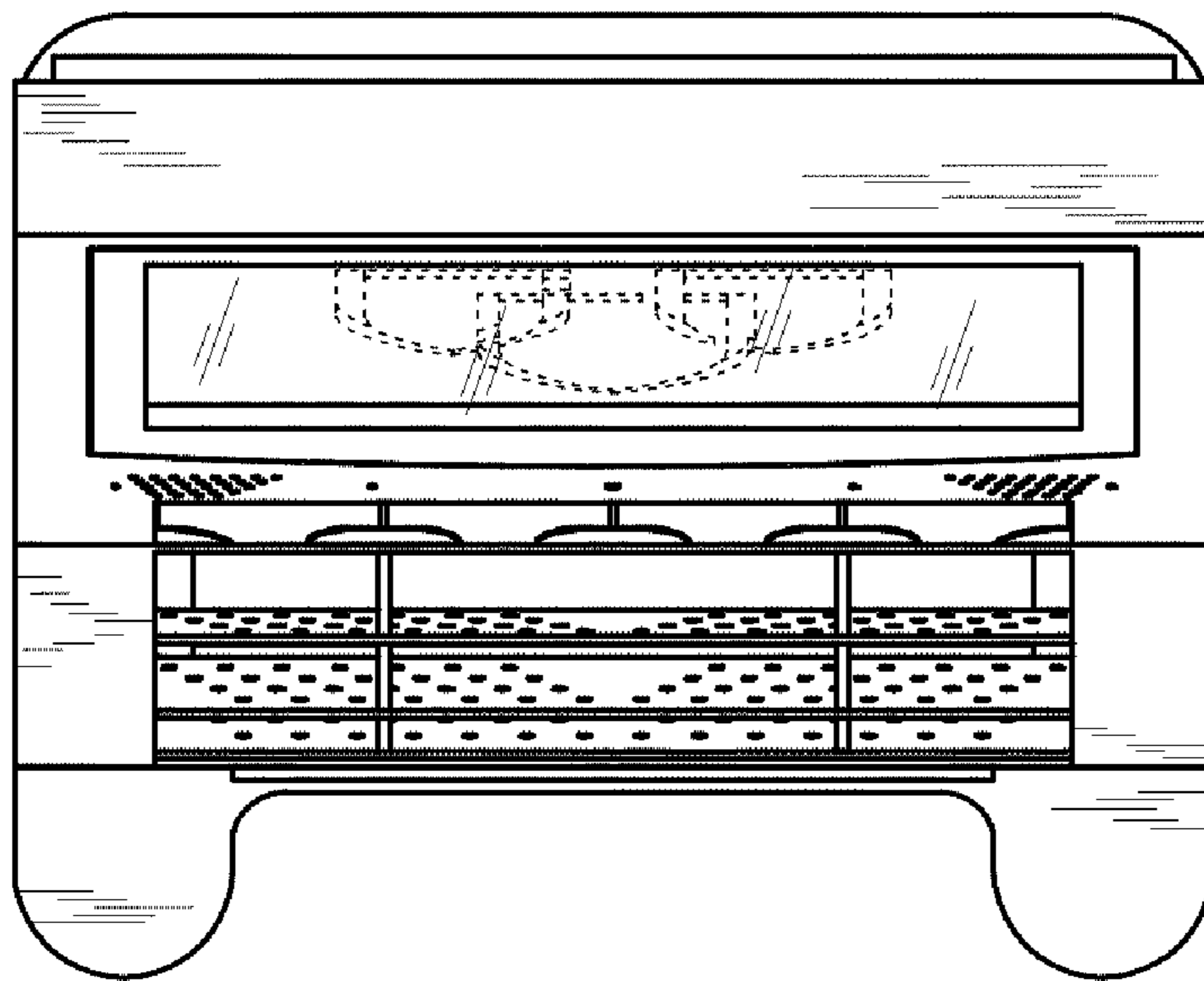

FIG. 7