



US00D643008S

(12) **United States Design Patent**
Chung

(10) **Patent No.:** **US D643,008 S**

(45) **Date of Patent:** **** Aug. 9, 2011**

(54) **MOBILE PHONE**

(75) **Inventor:** **Jin-Man Chung**, Goyang-si (KR)

(73) **Assignee:** **Samsung Electronics Co., Ltd.**,
Suwon-Si (KR)

(**) **Term:** **14 Years**

(21) **Appl. No.:** **29/380,509**

(22) **Filed:** **Dec. 7, 2010**

(30) **Foreign Application Priority Data**

Oct. 5, 2010 (KR) 30-2010-0043300

(51) **LOC (9) Cl.** **14-03**

(52) **U.S. Cl.** **D14/138 AA**

(58) **Field of Classification Search** D14/138 AA,
D14/496, 341, 345, 346, 203.3, 203.4, 203.7,
D14/138 AD, 138 R, 147, 218, 137; 455/575.1,
455/556.2, 575.3, 575.4; D21/517; 379/433.01,
379/433.04, 433.11, 433.12, 433.13; D13/168
See application file for complete search history.

(56) **References Cited**

U.S. PATENT DOCUMENTS

D499,709 S *	12/2004	Nuovo et al.	D14/138 AA
D515,537 S *	2/2006	Kim et al.	D14/138 AA
D543,184 S *	5/2007	Moon et al.	D14/138 AA
D543,185 S *	5/2007	Moon et al.	D14/138 AA
D559,224 S *	1/2008	Moon et al.	D14/138 AA
D562,297 S *	2/2008	Kim et al.	D14/138 AA
D562,301 S *	2/2008	Lee et al.	D14/138 AA
D573,570 S *	7/2008	Park et al.	D14/138 AA
D573,967 S *	7/2008	Tsai et al.	D14/138 AA
D576,990 S *	9/2008	Han et al.	D14/138 AA
D578,502 S *	10/2008	Kim et al.	D14/138 AA
D587,236 S *	2/2009	Haberl et al.	D14/147

D590,797 S *	4/2009	Finney et al.	D14/138 R
D595,680 S *	7/2009	Schellen	D14/138 AA
D596,599 S *	7/2009	Kim et al.	D14/138 AA
D597,045 S *	7/2009	Kim et al.	D14/138 AA
D605,620 S *	12/2009	Asmussen	D14/138 AA
D607,859 S *	1/2010	Stone	D14/138 AA
D608,751 S *	1/2010	He	D14/138 AA
D616,879 S *	6/2010	Kim et al.	D14/250
D623,159 S *	9/2010	Cheng et al.	D14/138 AA
D626,934 S *	11/2010	Lee et al.	D14/138 AA
D630,610 S *	1/2011	Li	D14/138 AA
2006/0121963 A1 *	6/2006	Gartrell et al.	455/575.8
2009/0247242 A1 *	10/2009	Wojack et al.	455/575.1

OTHER PUBLICATIONS

Samsung U100 telephone, announced Feb. 2007, [online], [site visited Mar. 25, 2011]. Available from Internet, <URL: <http://www.gsmarena.com>>.*

Samsung C5010 Squash telephone, announced May 2010, [online], [site visited Mar. 25, 2011]. Available from Internet, <URL: <http://www.gsmarena.com>>.*

* cited by examiner

Primary Examiner — Jeff D Asch

(74) *Attorney, Agent, or Firm* — Staas & Halsey LLP

(57) **CLAIM**

The ornamental design for a mobile phone, as shown and described.

DESCRIPTION

FIG. 1 is a front perspective view of a mobile phone;
FIG. 2 is a front view of the mobile phone of FIG. 1;
FIG. 3 is a rear view of the mobile phone of FIG. 1;
FIG. 4 is a left-side view of the mobile phone of FIG. 1;
FIG. 5 is a right-side view of the mobile phone of FIG. 1;
FIG. 6 is a top plan view of the mobile phone of FIG. 1; and,
FIG. 7 is a bottom plan view of the mobile phone of FIG. 1.

1 Claim, 7 Drawing Sheets

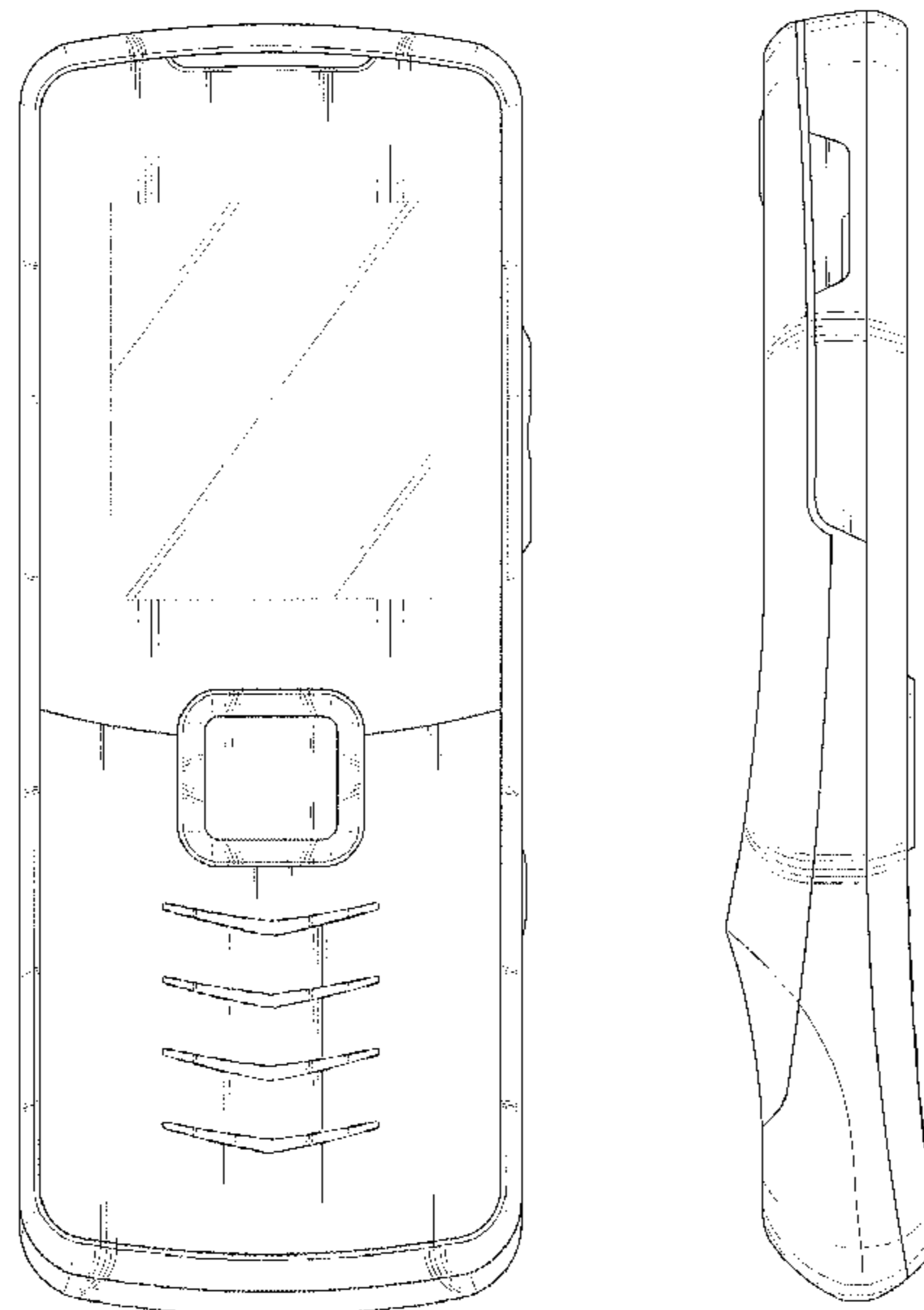

FIG. 1

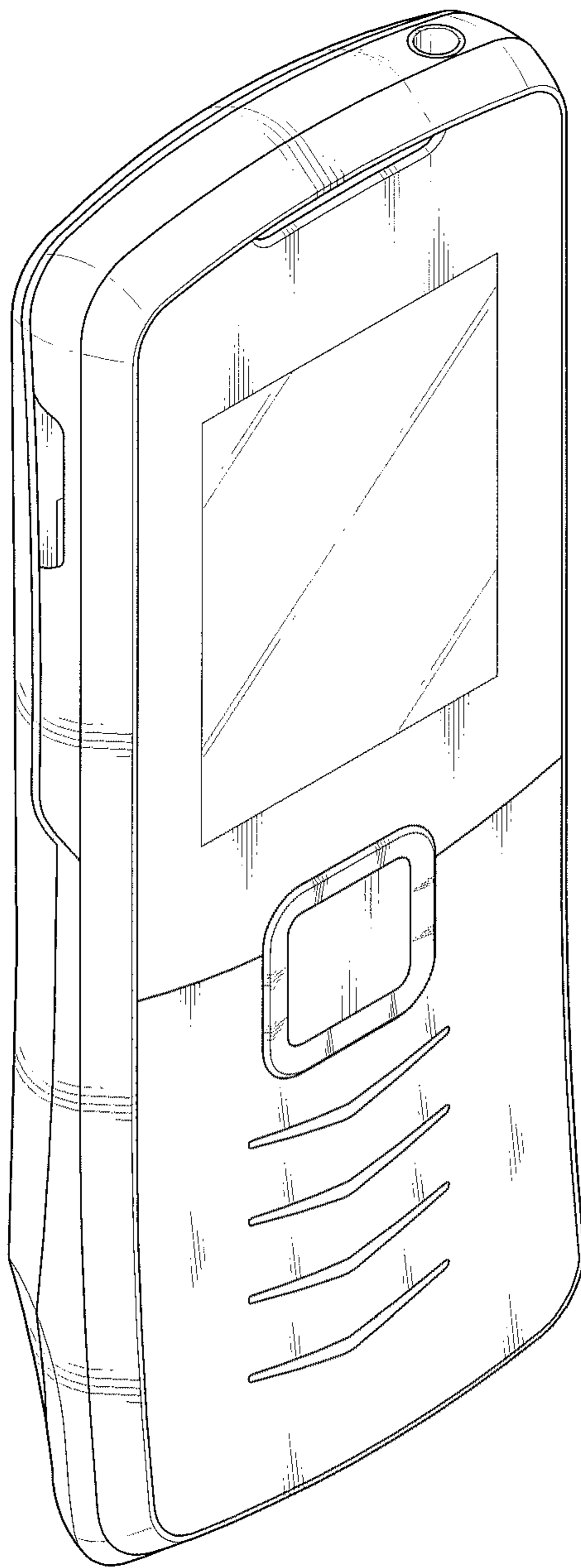

FIG. 2

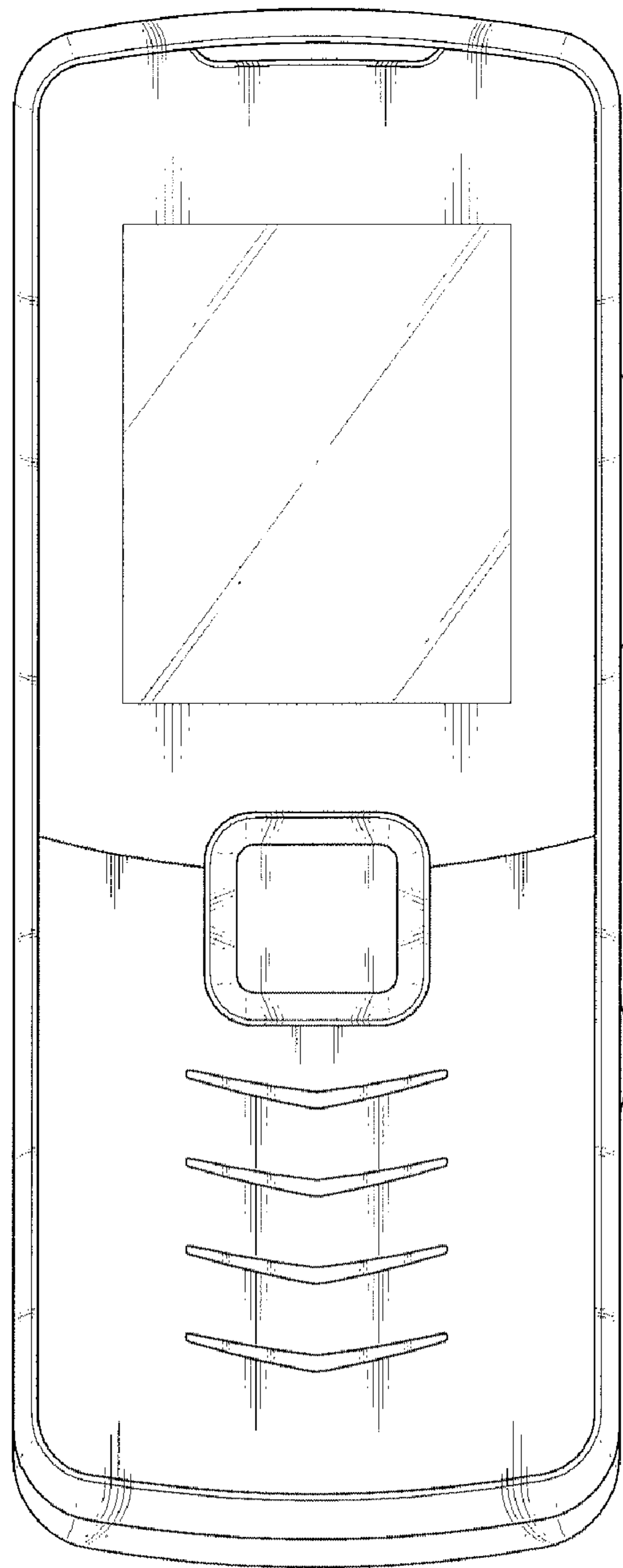

FIG. 3

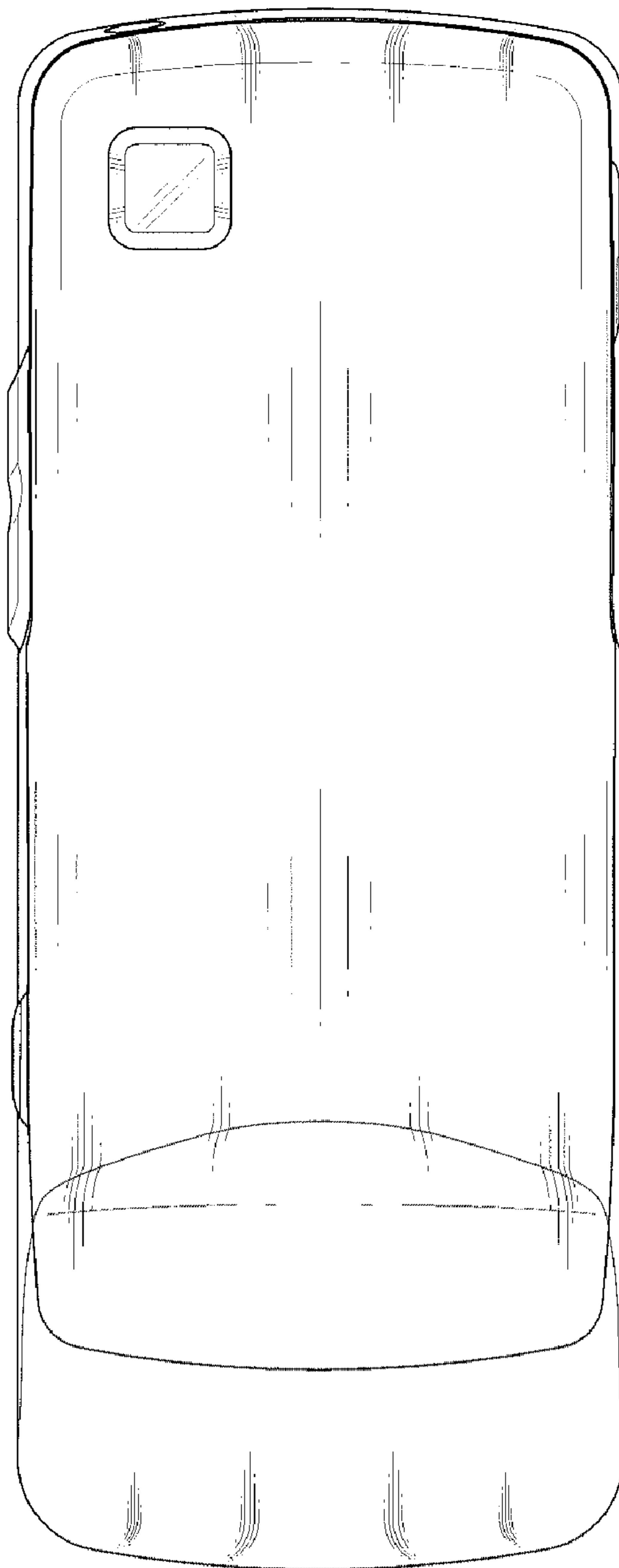

FIG. 4

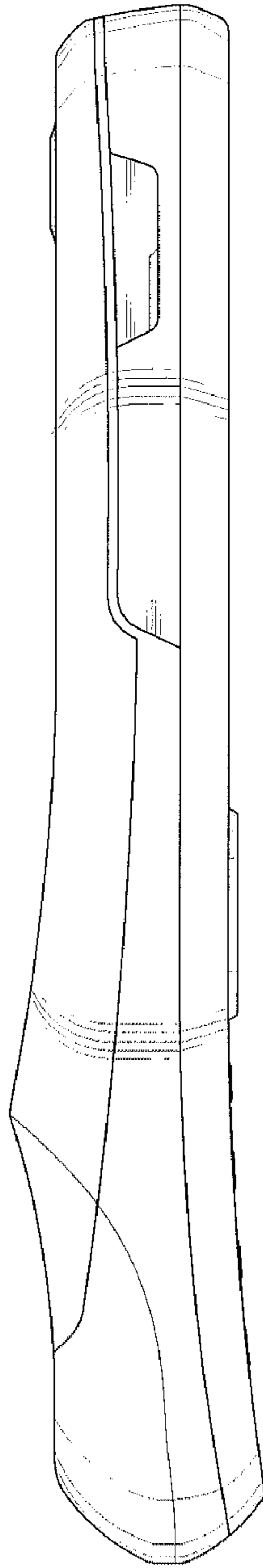

FIG. 5

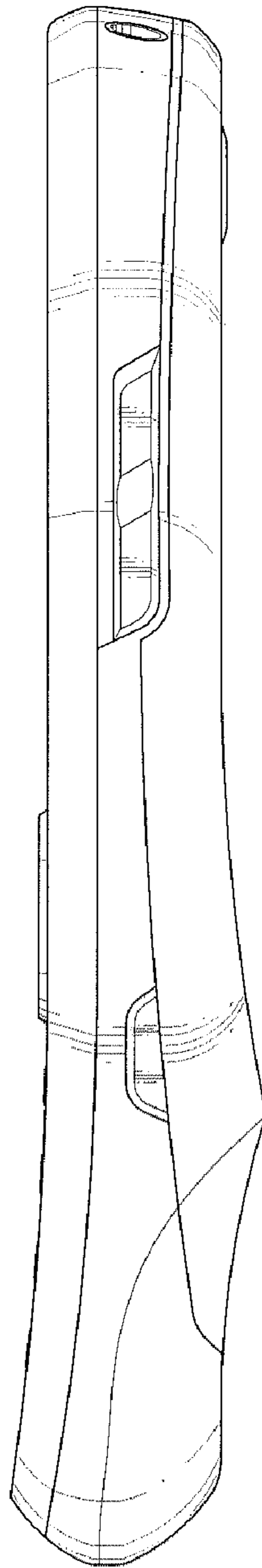

FIG. 6

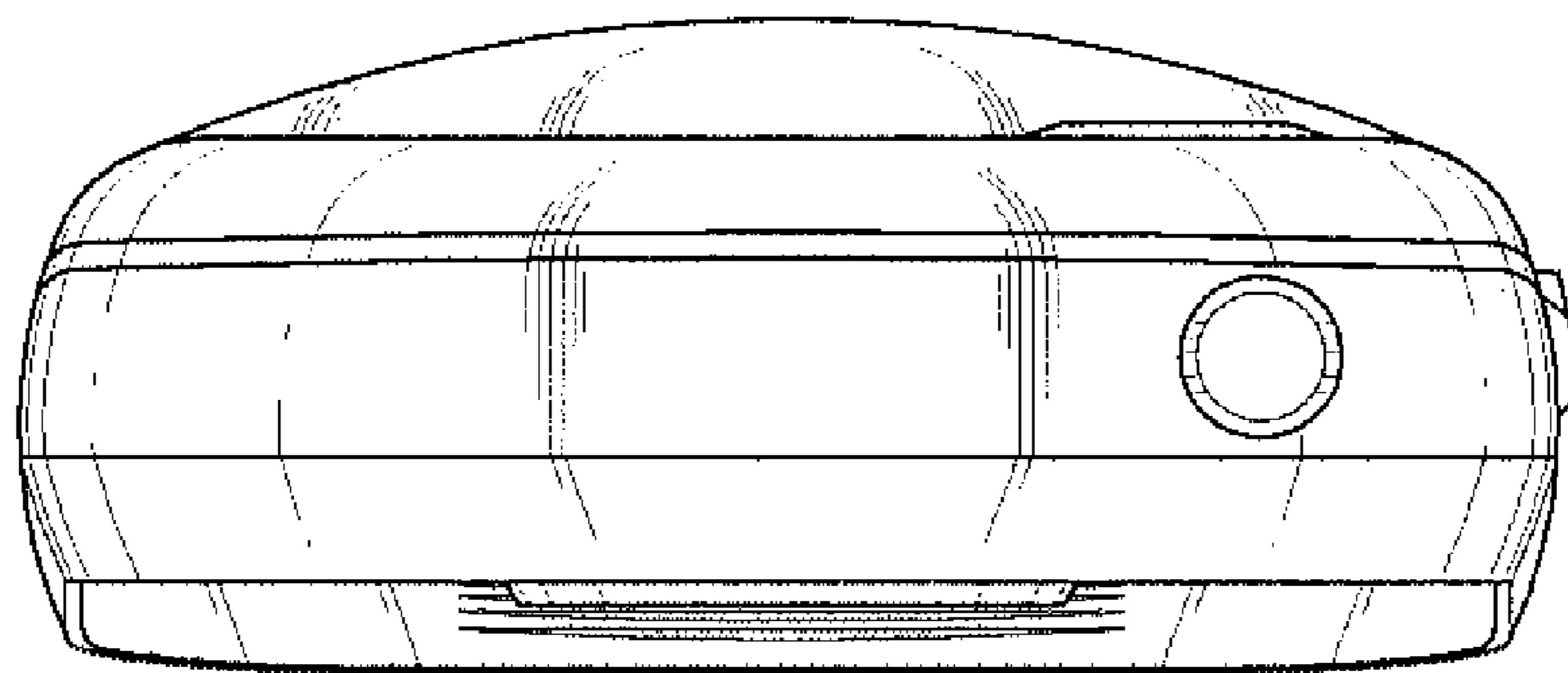

FIG. 7

