



US00D643001S

(12) **United States Design Patent**
Shimizu

(10) **Patent No.:** **US D643,001 S**

(45) **Date of Patent:** **** Aug. 9, 2011**

(54) **DISPLAY DEVICE**

(75) Inventor: **Akari Shimizu**, Osaka (JP)

(73) Assignee: **Funai Electric Co., Ltd.**, Osaka (JP)

(**) Term: **14 Years**

(21) Appl. No.: **29/382,457**

(22) Filed: **Jan. 4, 2011**

(51) **LOC (9) Cl.** **14-03**

(52) **U.S. Cl.** **D14/126**

(58) **Field of Classification Search** D14/125-134,
D14/239, 371, 136, 374-377, 440, 450, 448,
D14/336, 342; 312/7.2; 348/836, 838, 180,
348/184, 325, 739; 341/12; 248/917-924,
248/465; 345/104, 133, 156, 168, 87, 173;
720/605, 669, 600, 655; 369/99, 197; D21/329,
D21/515, 577, 622, 333, 433, 448, 452, 450,
D21/331; D6/477, 479, 300; 273/148 B;
446/484, 175, 356; D10/15, 26

See application file for complete search history.

(56) **References Cited**

U.S. PATENT DOCUMENTS

D523,828 S *	6/2006	Hoehn et al.	D14/126
D587,712 S *	3/2009	Park et al.	D14/375
D601,104 S *	9/2009	Kim	D14/126
D626,925 S *	11/2010	Li	D14/126

* cited by examiner

Primary Examiner — Raphael Barkai

(74) *Attorney, Agent, or Firm* — Sughrue Mion, PLLC

(57) **CLAIM**

The ornamental design for a display device, as shown and described.

DESCRIPTION

FIG. 1 is a perspective view of the top, front and right of a display device showing our new design;
FIG. 2 is a front view thereof;
FIG. 3 is a rear view thereof;
FIG. 4 is a top plan view thereof;
FIG. 5 is a bottom view thereof;
FIG. 6 is a left side view thereof; and,
FIG. 7 is a right side view thereof.

1 Claim, 5 Drawing Sheets

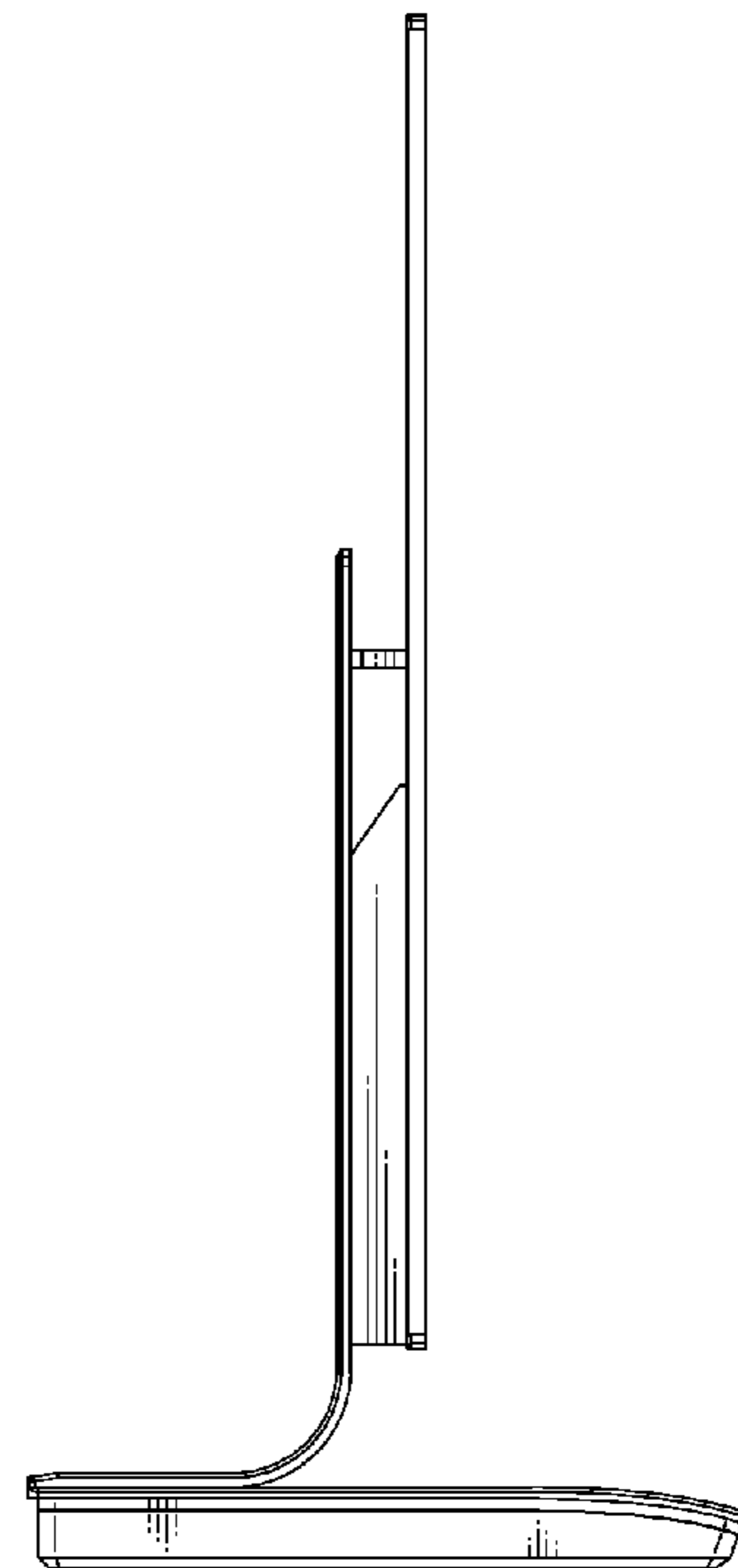
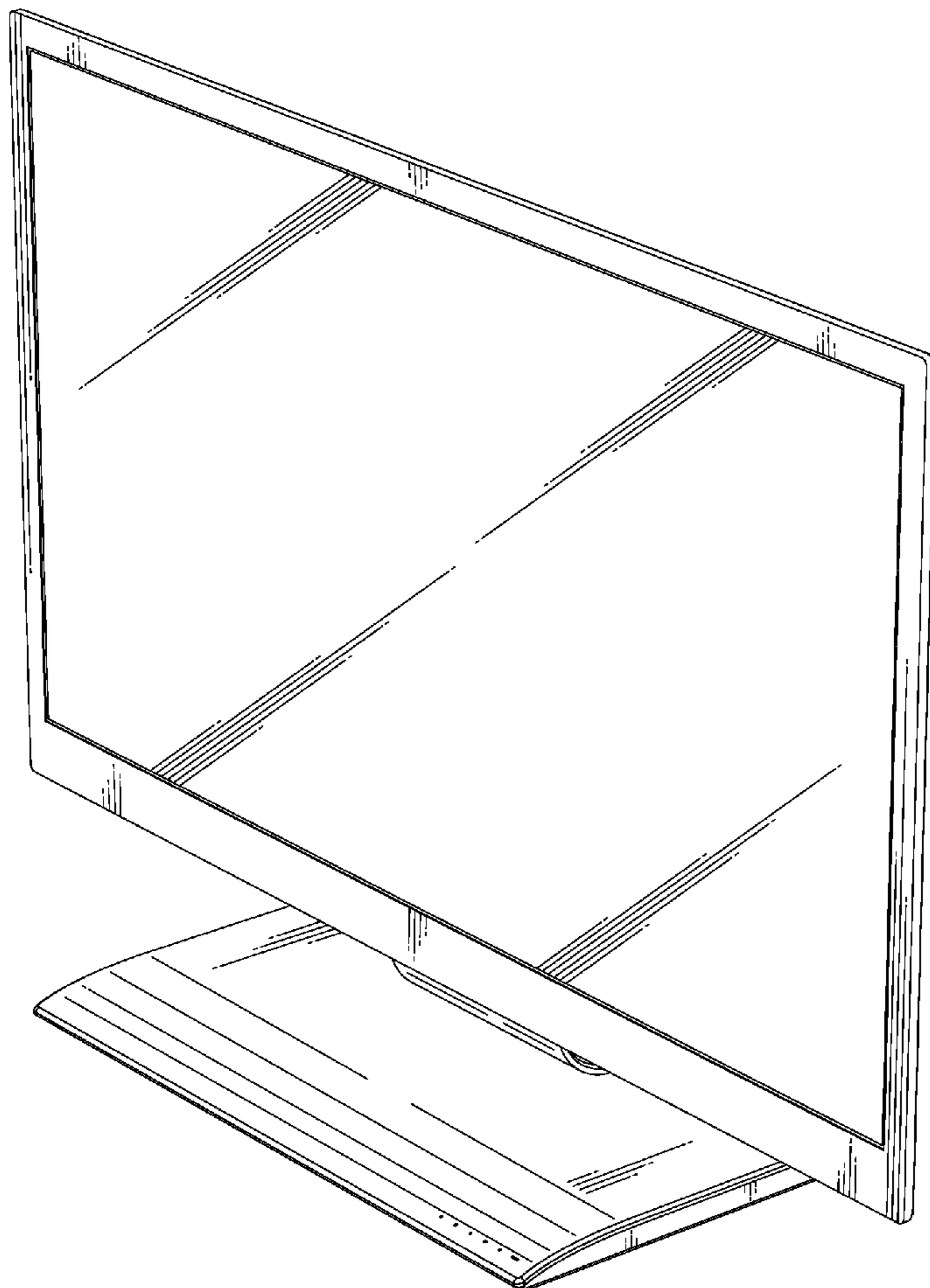

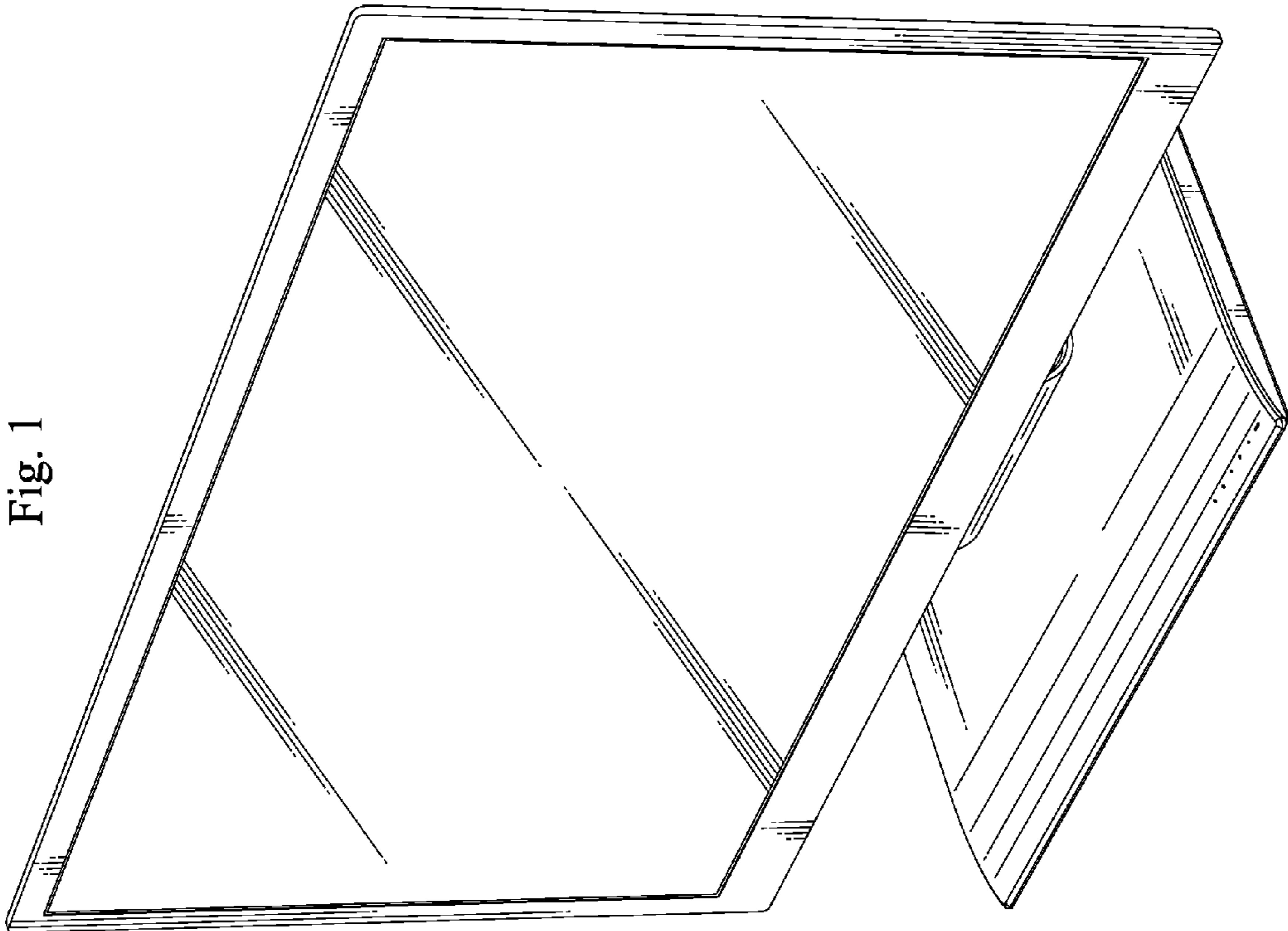

Fig. 1

Fig. 2

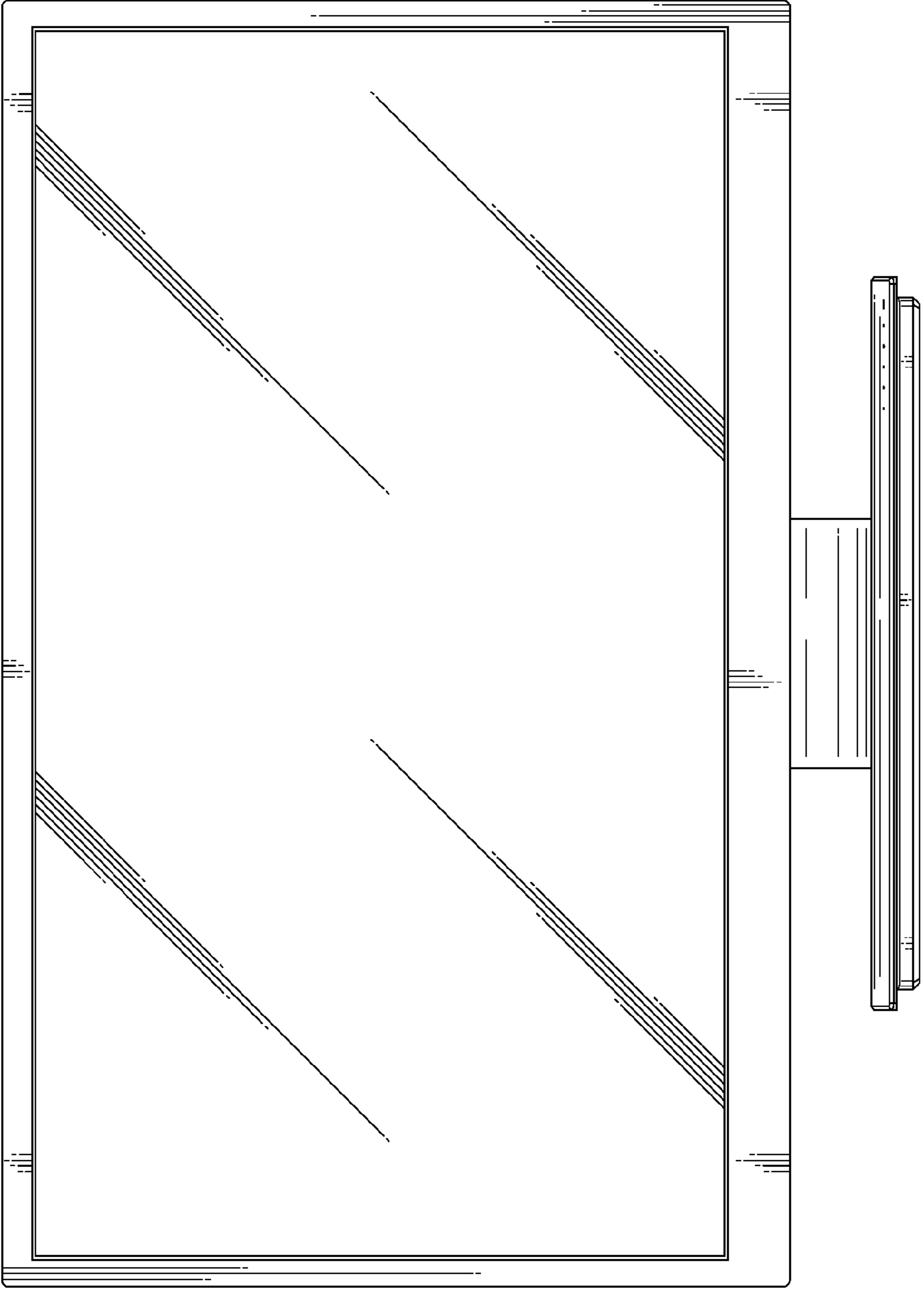

Fig. 3

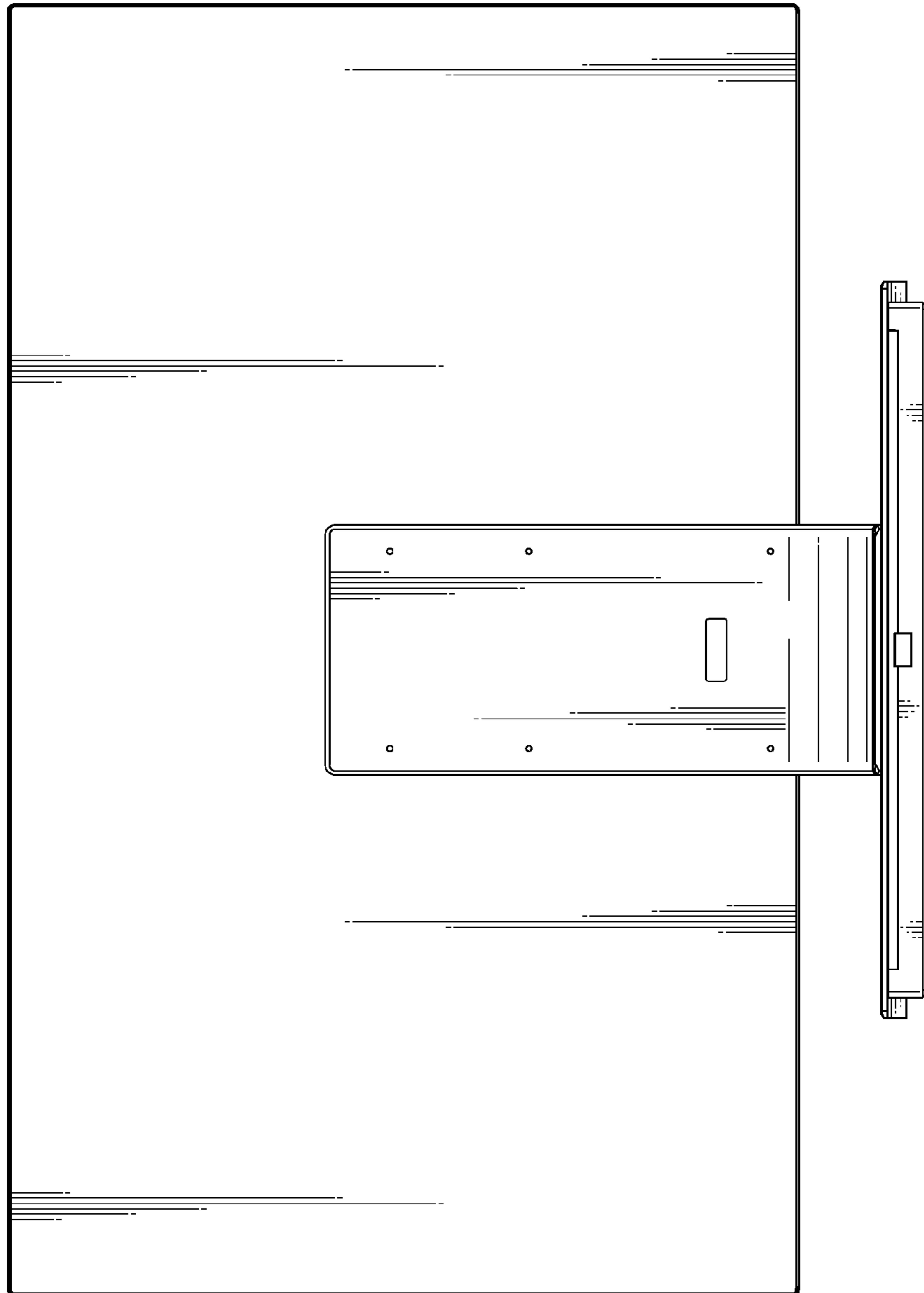

Fig. 4

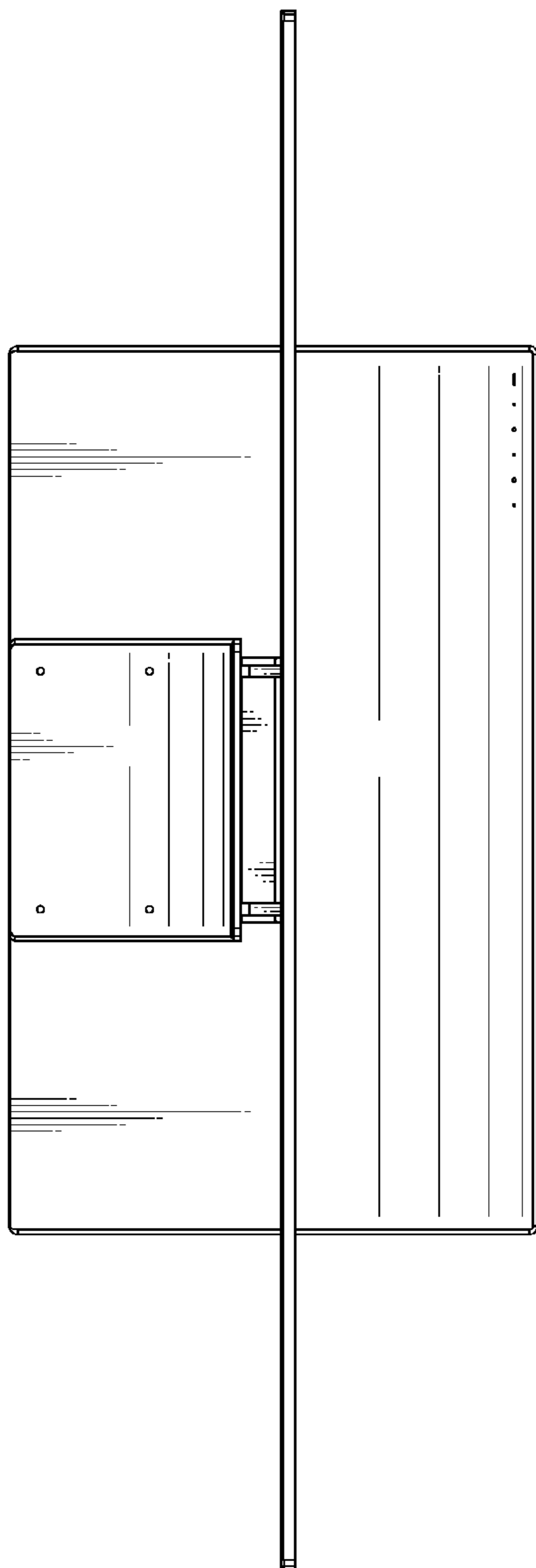

Fig. 5

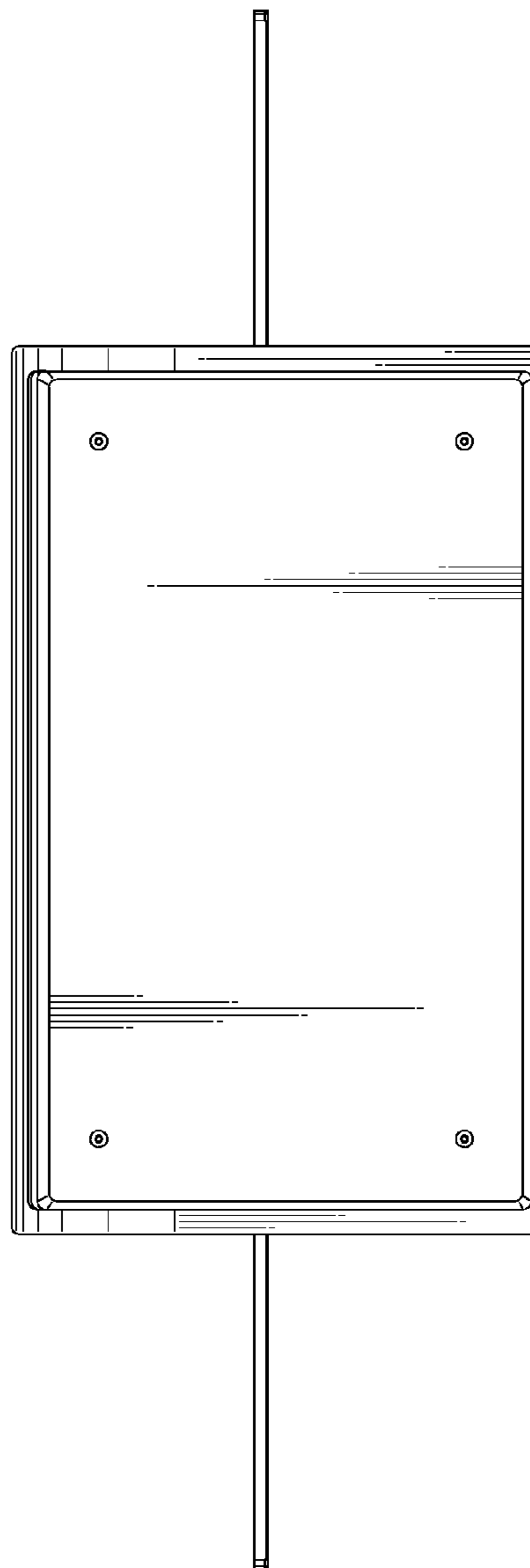

Fig. 7

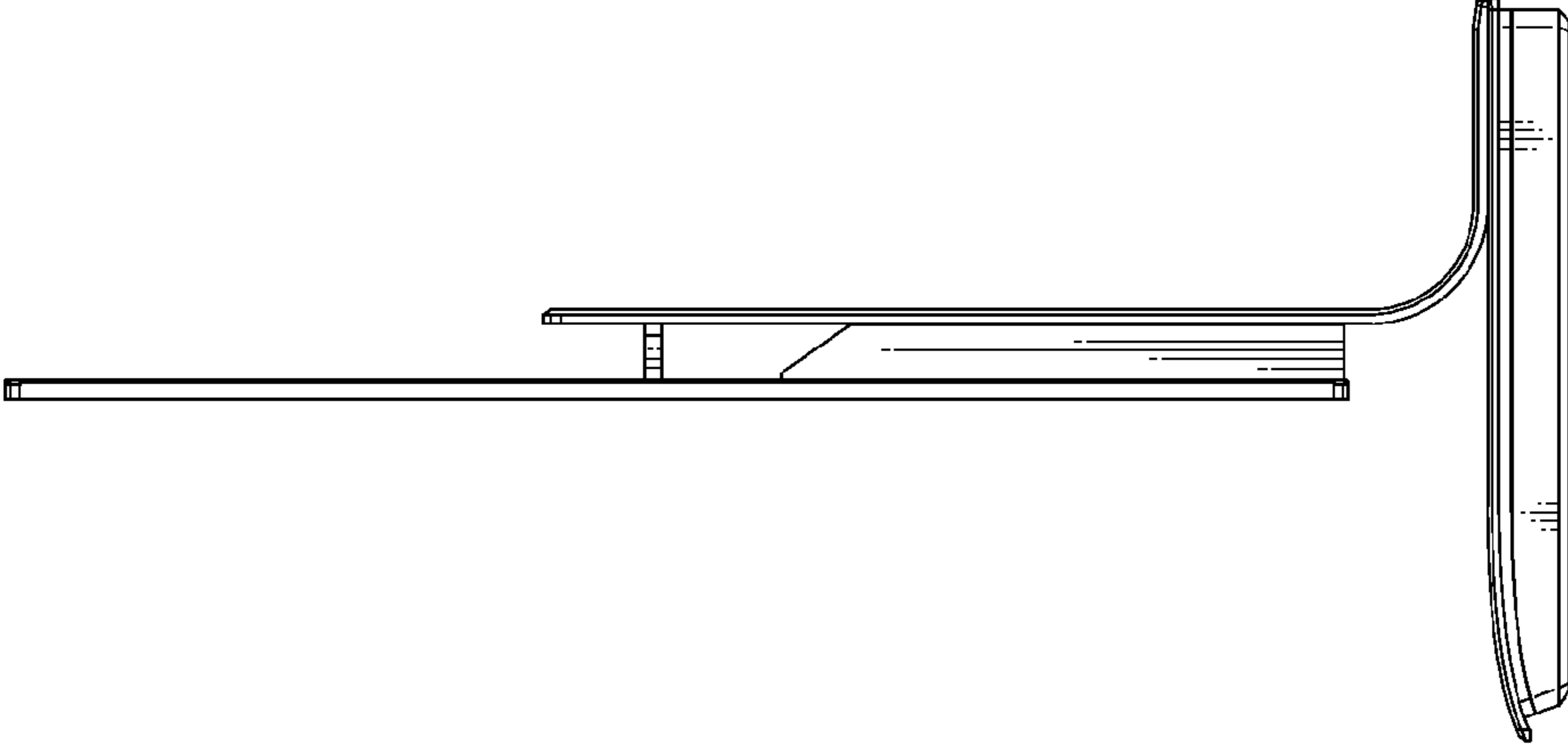

Fig. 6

