



US00D642867S

(12) **United States Design Patent**
Miller et al.

(10) **Patent No.:** **US D642,867 S**
(45) **Date of Patent:** **** Aug. 9, 2011**

- (54) **TRAINING CUP**
- (75) Inventors: **Charles H. Miller**, Barnhart, MO (US);
Phil Holsinger, Duluth, MN (US);
Roger Avery, Cumberland, RI (US)
- (73) Assignee: **Handi-Craft Company**, St. Louis, MO (US)
- (**) Term: **14 Years**
- (21) Appl. No.: **29/362,416**
- (22) Filed: **May 25, 2010**

- 5,747,083 A 5/1998 Raymond et al.
- 5,779,071 A 7/1998 Brown et al.
- 5,791,503 A 8/1998 Lyons
- 5,890,619 A 4/1999 Belanger
- 5,890,620 A 4/1999 Belcastro
- 5,890,621 A 4/1999 Bachman et al.
- 5,950,857 A 9/1999 Rosen
- 5,988,425 A 11/1999 Yehl et al.
- 6,037,872 A 3/2000 Dunnun
- 6,050,445 A 4/2000 Manganiello
- D425,994 S * 5/2000 Hakim D24/197
- 6,079,589 A 6/2000 Matsuyama et al.
- D429,312 S 8/2000 Poirier et al.
- 6,102,244 A 8/2000 Kuwano et al.
- 6,102,245 A 8/2000 Haberman
- 6,116,457 A 9/2000 Haberman

(Continued)

Related U.S. Application Data

- (62) Division of application No. 29/337,517, filed on May 22, 2009, now Pat. No. Des. 619,851.
- (51) **LOC (9) Cl.** **07-01**
- (52) **U.S. Cl.** **D7/510; D7/511; D7/534; D24/197**
- (58) **Field of Classification Search** **D7/534, D7/533, 510, 511; D9/533; 215/11.1; 220/710.5, 220/714, 717, 703; D24/197**
See application file for complete search history.

Primary Examiner — Marianne Pandozzi

(74) *Attorney, Agent, or Firm* — Armstrong Teasdale LLP

(57) **CLAIM**

The ornamental design for a training cup, as shown and described.

DESCRIPTION

FIG. 1 is a perspective view of a training cup showing a first embodiment of our new design;
 FIG. 2 is a front elevation thereof;
 FIG. 3 is a rear elevation thereof;
 FIG. 4 is a right side elevational view thereof, the left side elevational view being identical;
 FIG. 5 is a top plan view thereof; and
 FIG. 6 is a bottom plan view thereof;
 FIG. 7 is a perspective view of a training cup showing a second embodiment of our new design;
 FIG. 8 is a front elevation thereof;
 FIG. 9 is a rear elevation thereof;
 FIG. 10 is a right side elevational view thereof, the left side elevational view being identical;
 FIG. 11 is a top plan view thereof; and,
 FIG. 12 is a bottom plan view thereof.

1 Claim, 12 Drawing Sheets

(56) **References Cited**

U.S. PATENT DOCUMENTS

- 3,915,331 A 10/1975 Chenault
- 4,623,069 A 11/1986 White
- 4,993,568 A 2/1991 Morifuji et al.
- D315,213 S * 3/1991 Ohnuki D24/197
- 5,071,017 A 12/1991 Stull
- 5,079,013 A 1/1992 Belanger
- 5,101,991 A 4/1992 Morifuji et al.
- 5,101,992 A 4/1992 Serre
- 5,186,347 A 2/1993 Freeman et al.
- D368,529 S * 4/1996 Allegre D24/197
- 5,542,670 A 8/1996 Morano
- 5,570,796 A 11/1996 Brown et al.
- 5,598,809 A 2/1997 McInnes
- 5,667,084 A 9/1997 Duggal et al.
- 5,690,679 A 11/1997 Prentiss
- 5,706,973 A 1/1998 Robbins, III et al.

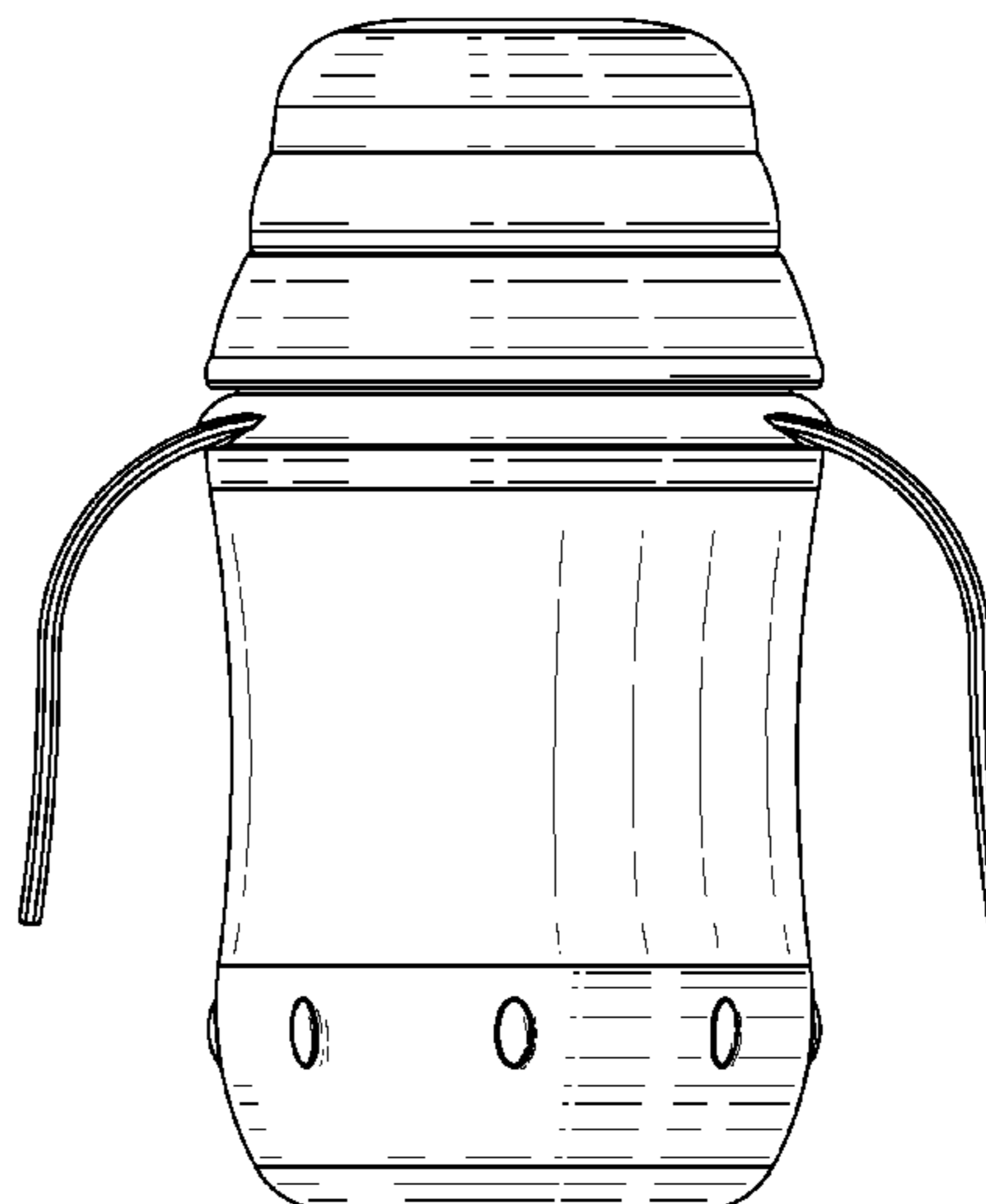
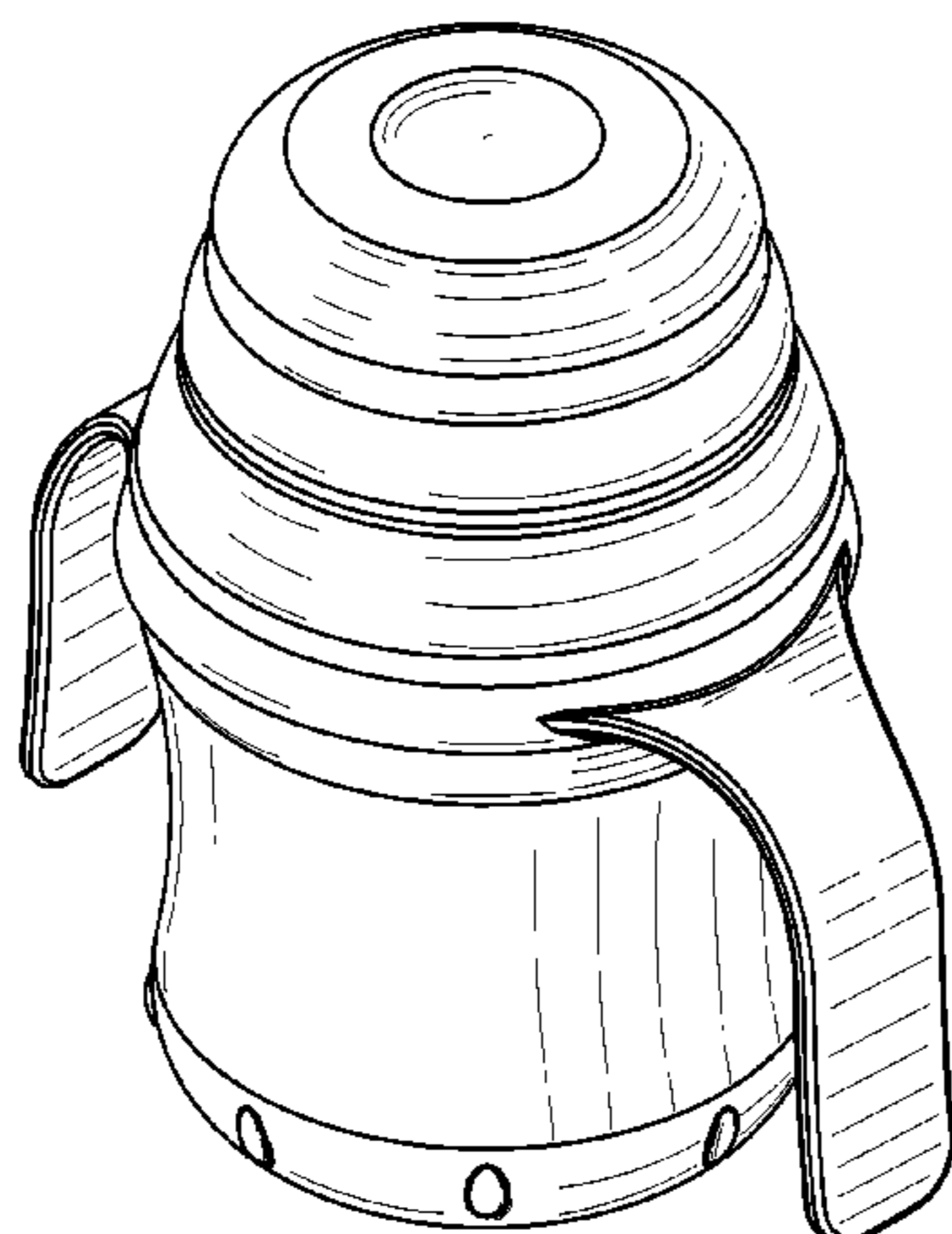

US D642,867 S

Page 2

U.S. PATENT DOCUMENTS

D433,729	S	11/2000	Poirier et al.				
RE037,016	E	1/2001	Morano				
6,202,877	B1	3/2001	La Torre et al.				
D441,087	S *	4/2001	Johansen et al.	D24/197		
6,230,923	B1	5/2001	Hung				
6,260,731	B1	7/2001	Cummings				
6,269,968	B1	8/2001	Belcastro				
D448,242	S	9/2001	McDonough et al.				
D448,976	S	10/2001	McDonough et al.				
6,305,570	B1	10/2001	Atkin et al.				
D450,535	S	11/2001	McDonough et al.				
6,321,931	B1 *	11/2001	Hakim et al.	220/714		
6,325,236	B1	12/2001	Wong				
D454,642	S *	3/2002	Hakim	D24/197		
6,357,620	B1	3/2002	Hakim				
6,365,202	B1	4/2002	Ida et al.				
6,422,415	B1	7/2002	Manganiello				
6,502,418	B2	1/2003	Holley, Jr.				
6,508,379	B1	1/2003	Van De Pol-Klein Nagelvoort et al.				
6,513,379	B2	2/2003	Meyers et al.				
6,565,743	B1	5/2003	Poirier et al.				
6,568,557	B2	5/2003	Fusco et al.				
D476,849	S *	7/2003	Randolph	D7/510		
6,607,092	B2	8/2003	Manganiello et al.				
6,609,630	B1	8/2003	Freeman et al.				
6,629,624	B2	10/2003	Stillinger et al.				
6,631,823	B2	10/2003	Stillinger et al.				
6,631,832	B2	10/2003	Wan et al.				
6,644,510	B2	11/2003	Kawolics et al.				
6,685,042	B2	2/2004	McIntyre et al.				
6,732,882	B2	5/2004	Belcastro				
6,758,364	B1	7/2004	Rohrig				
6,783,020	B2	8/2004	Featherston et al.				
6,786,352	B2	9/2004	Belcastro				
RE038,692	E	2/2005	Wong				
D515,867	S *	2/2006	Randolph et al.	D7/396.2		
7,108,676	B2	9/2006	Loging				
D538,939	S *	3/2007	Conaway et al.	D24/197		
7,243,814	B2	7/2007	Hakim				
D551,021	S *	9/2007	Rousso et al.	D7/510		
D555,428	S	11/2007	Tulett				
D559,622	S *	1/2008	Carreno	D7/510		
D559,624	S *	1/2008	Carreno	D7/534		
D589,153	S *	3/2009	Rosales	D24/197		
7,562,789	B2 *	7/2009	Randolph et al.	220/710.5		
7,575,126	B2	8/2009	Kemper				
D609,528	S *	2/2010	Roehrig et al.	D7/510		
2001/0020623	A1	9/2001	McDonough et al.				
2001/0027956	A1	10/2001	Bonacorso et al.				
2001/0035420	A1	11/2001	Fusco et al.				
2002/0033399	A1	3/2002	Manganiello et al.				
2002/0158075	A1	10/2002	Caldicott et al.				
2002/0179615	A1	12/2002	Hakim				
2002/0185495	A1	12/2002	Manganiello				
2003/0209555	A1	11/2003	Belcastro				
2004/0099674	A1	5/2004	McDonough et al.				
2004/0124170	A1	7/2004	Sherrod				
2004/0173623	A1	9/2004	Yuen				
2004/0222229	A1	11/2004	Gabbard				
2005/0045647	A1	3/2005	Hession et al.				
2005/0072788	A1	4/2005	Lieberman et al.				
2005/0098567	A1	5/2005	Randolph				
2005/0167438	A1	8/2005	Minyayev				
2005/0205589	A1	9/2005	Davis et al.				
2006/0037963	A1	2/2006	Pillado				
2006/0151499	A1	7/2006	Lieberman et al.				
2006/0169694	A1	8/2006	Kemper				
2007/0138121	A1	6/2007	Stribling et al.				

* cited by examiner

FIG. 1

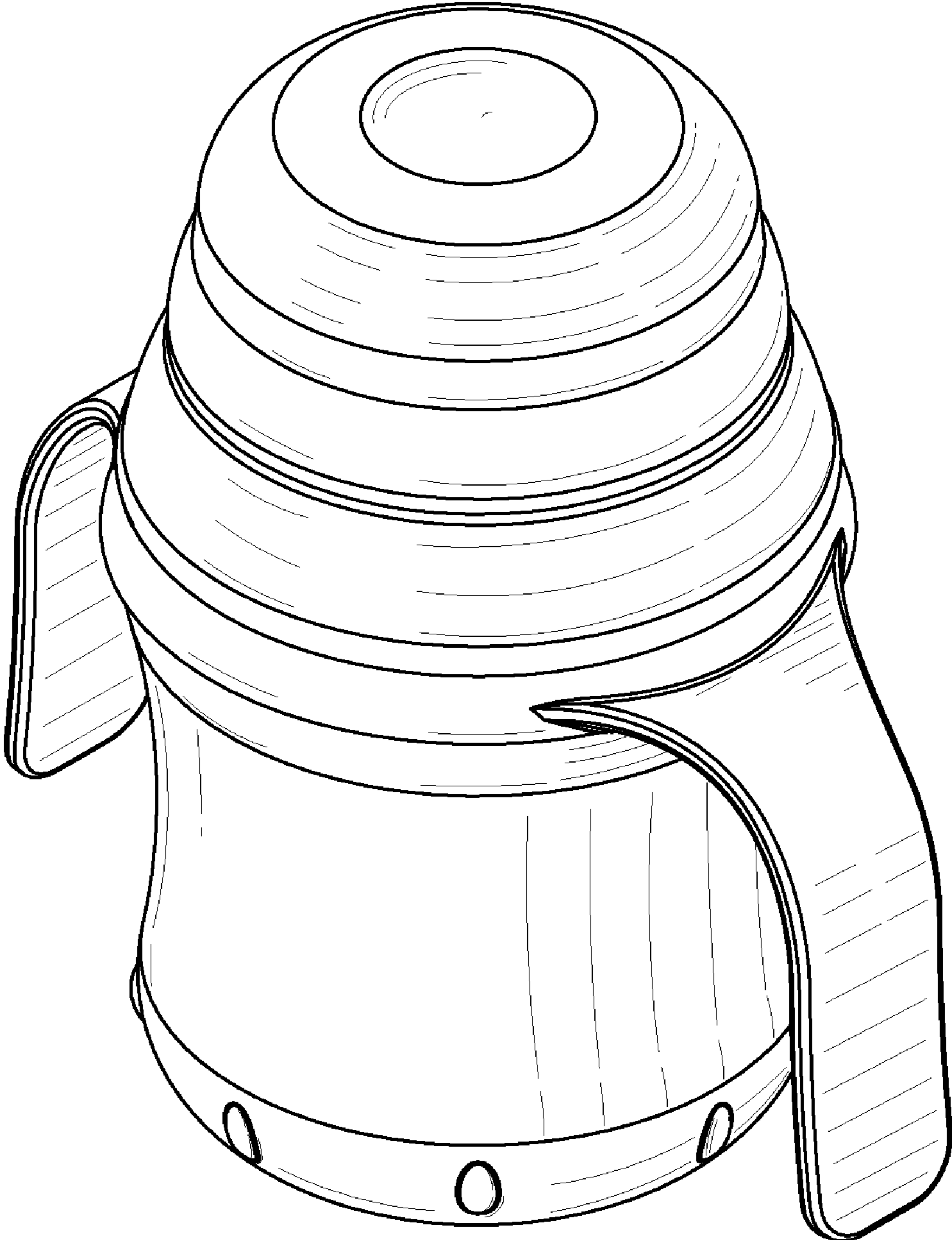

FIG. 2

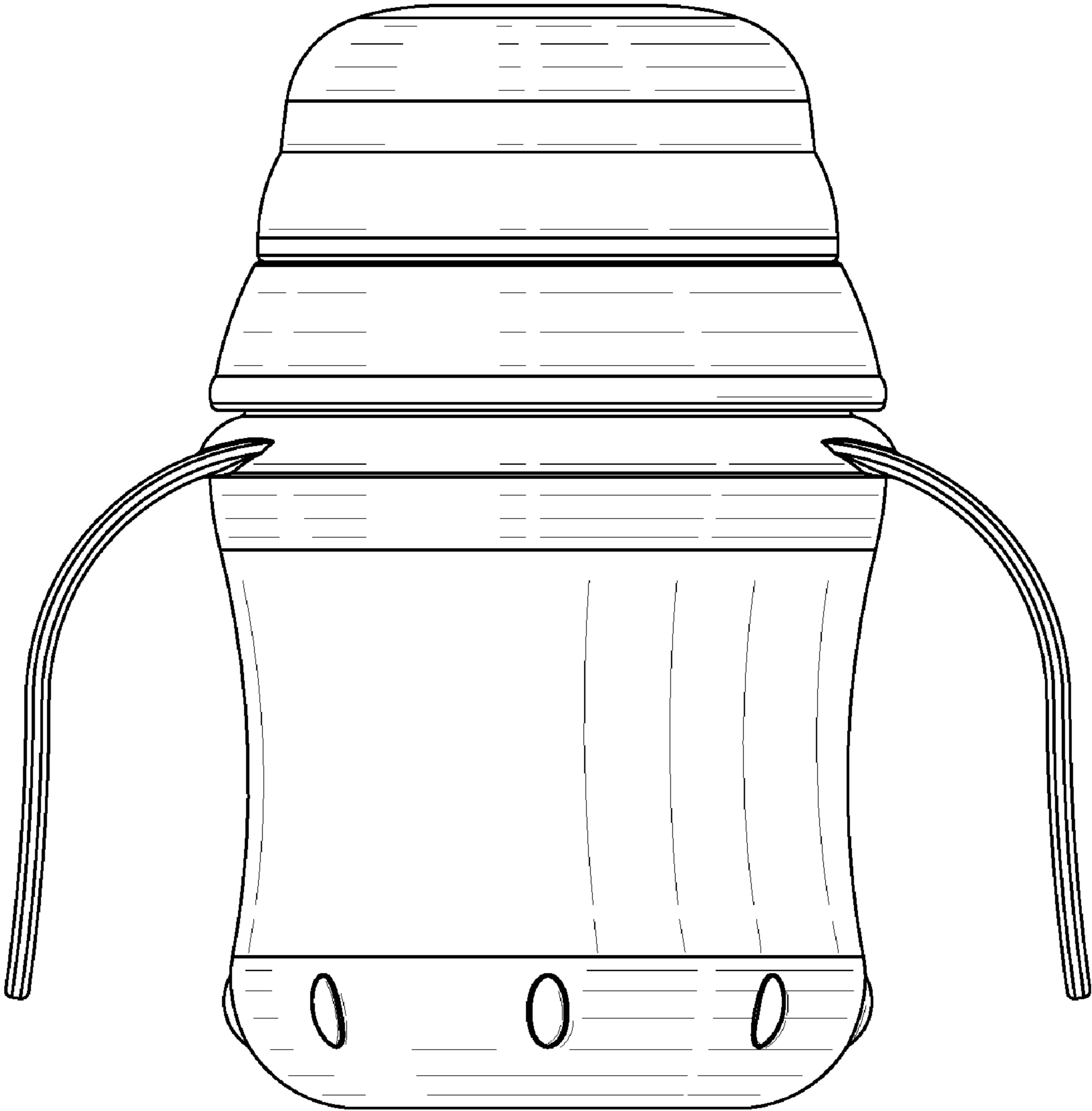

FIG. 3

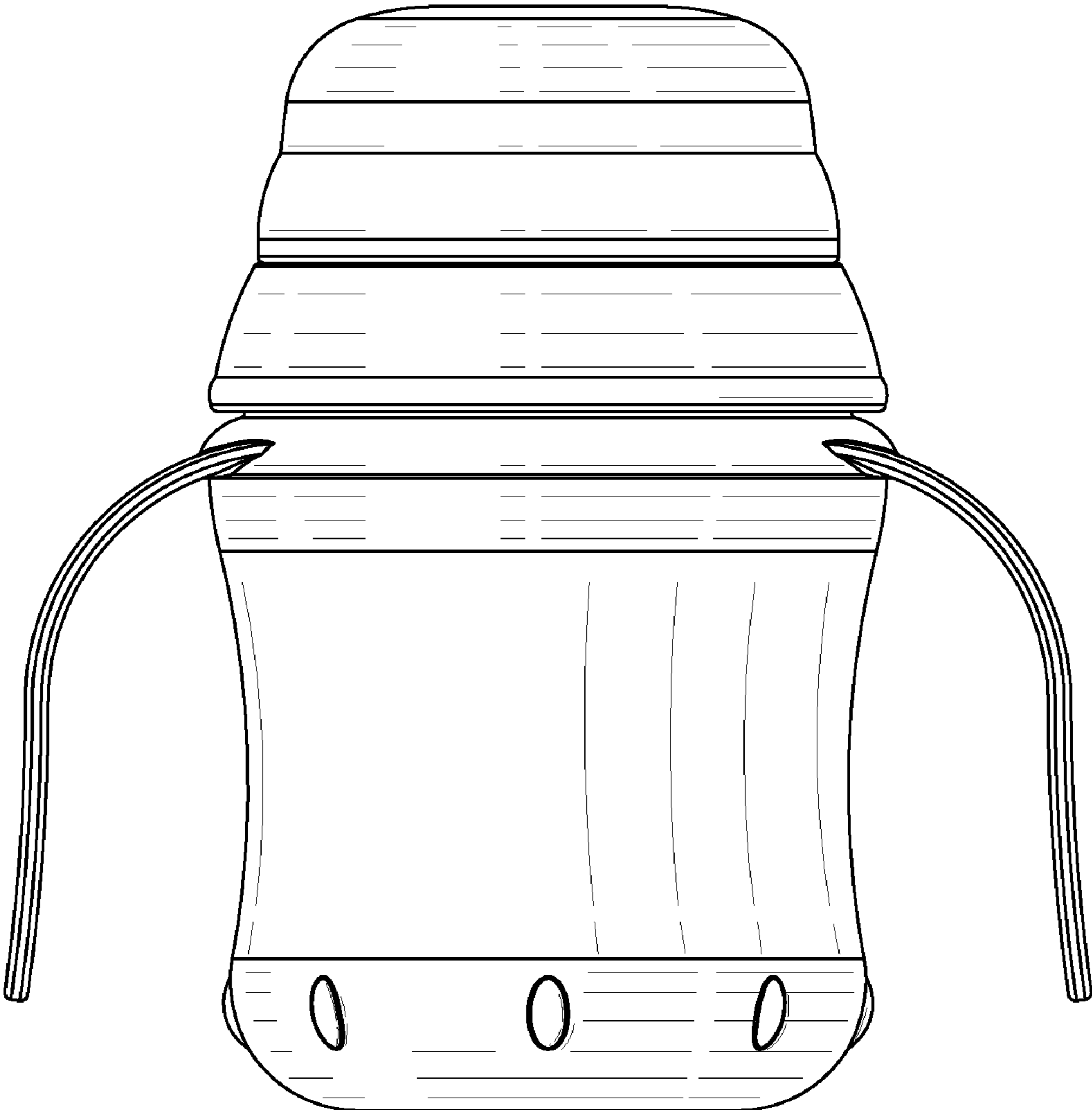

FIG. 4

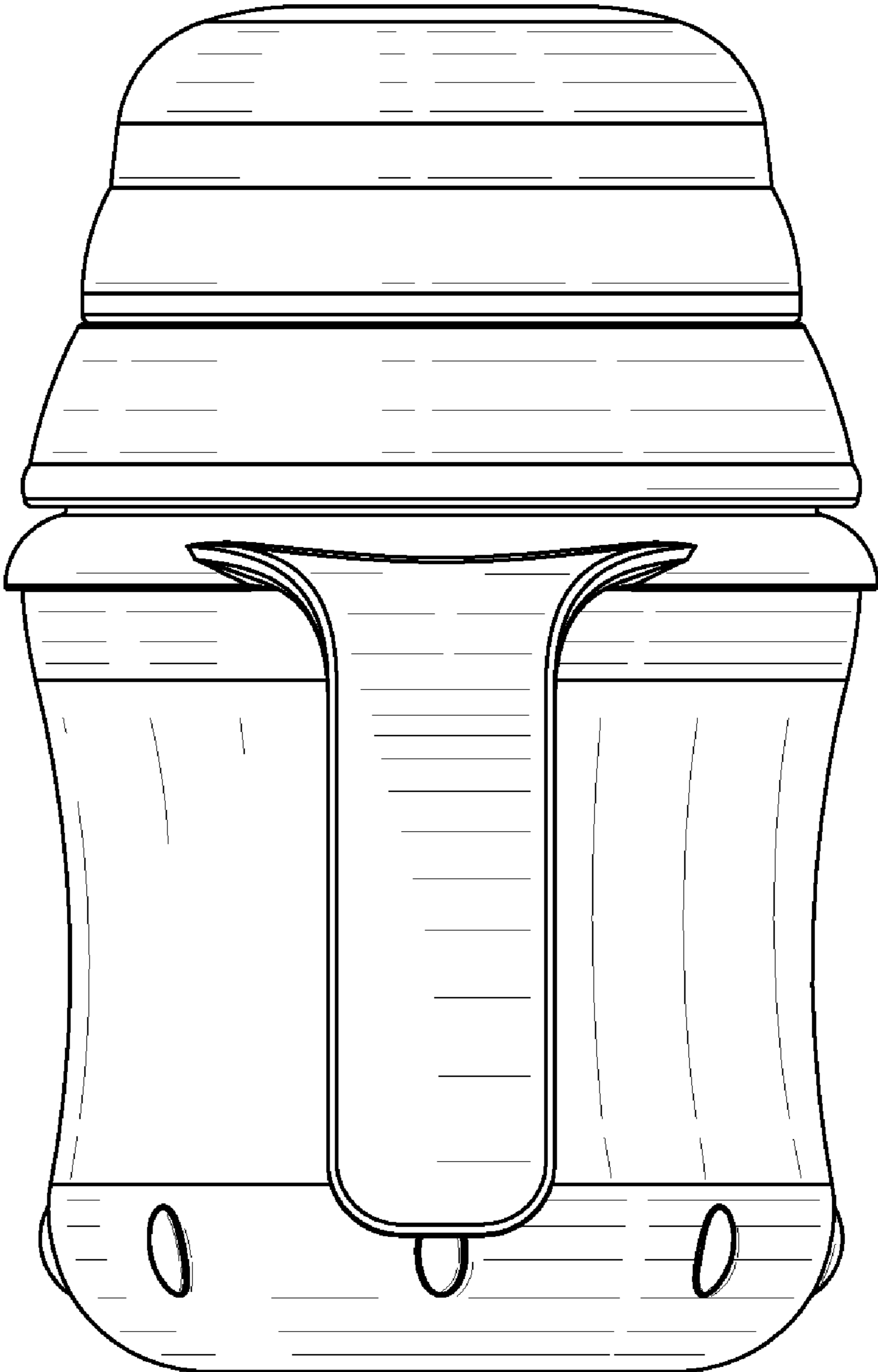

FIG. 5

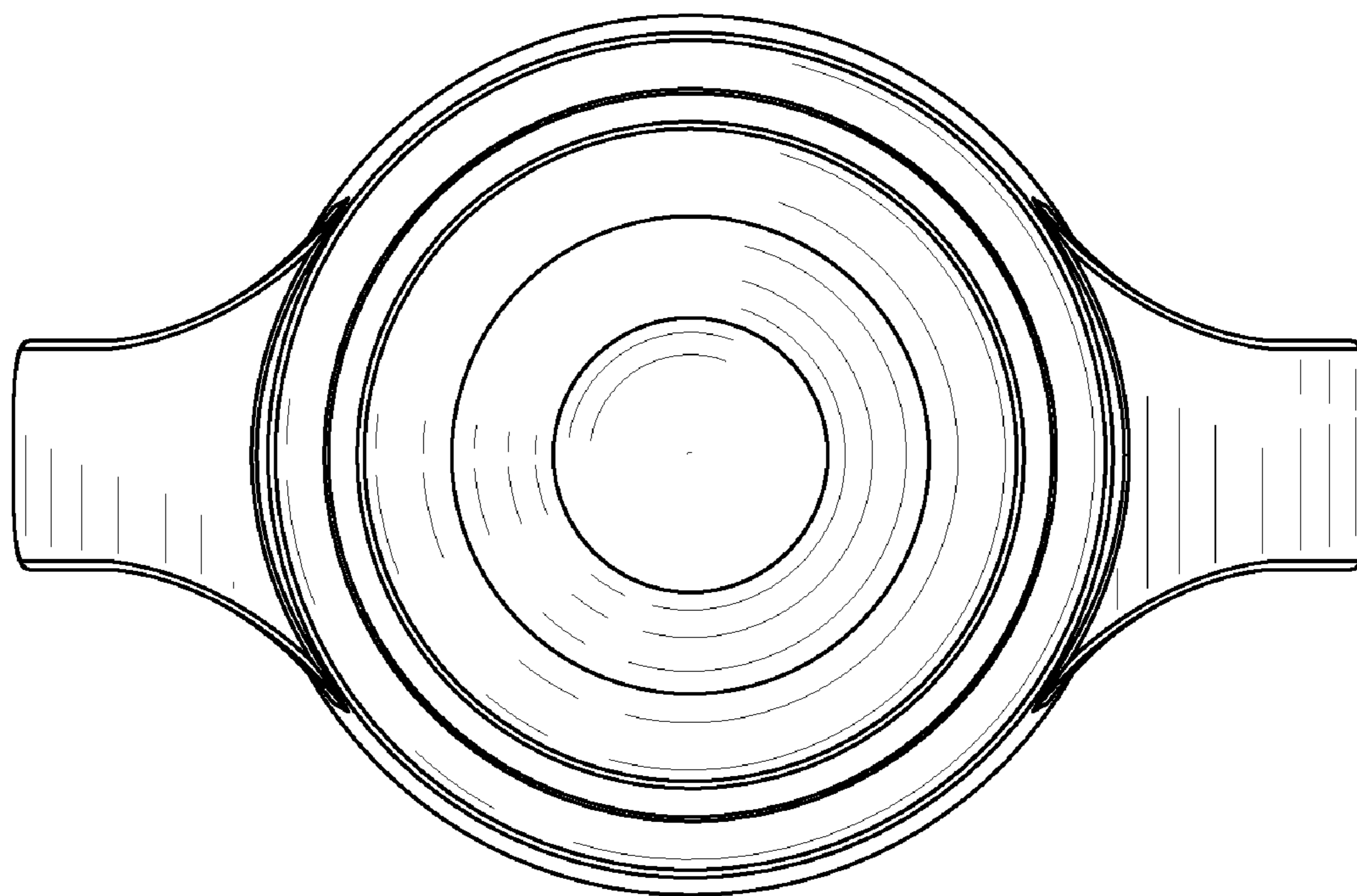

FIG. 6

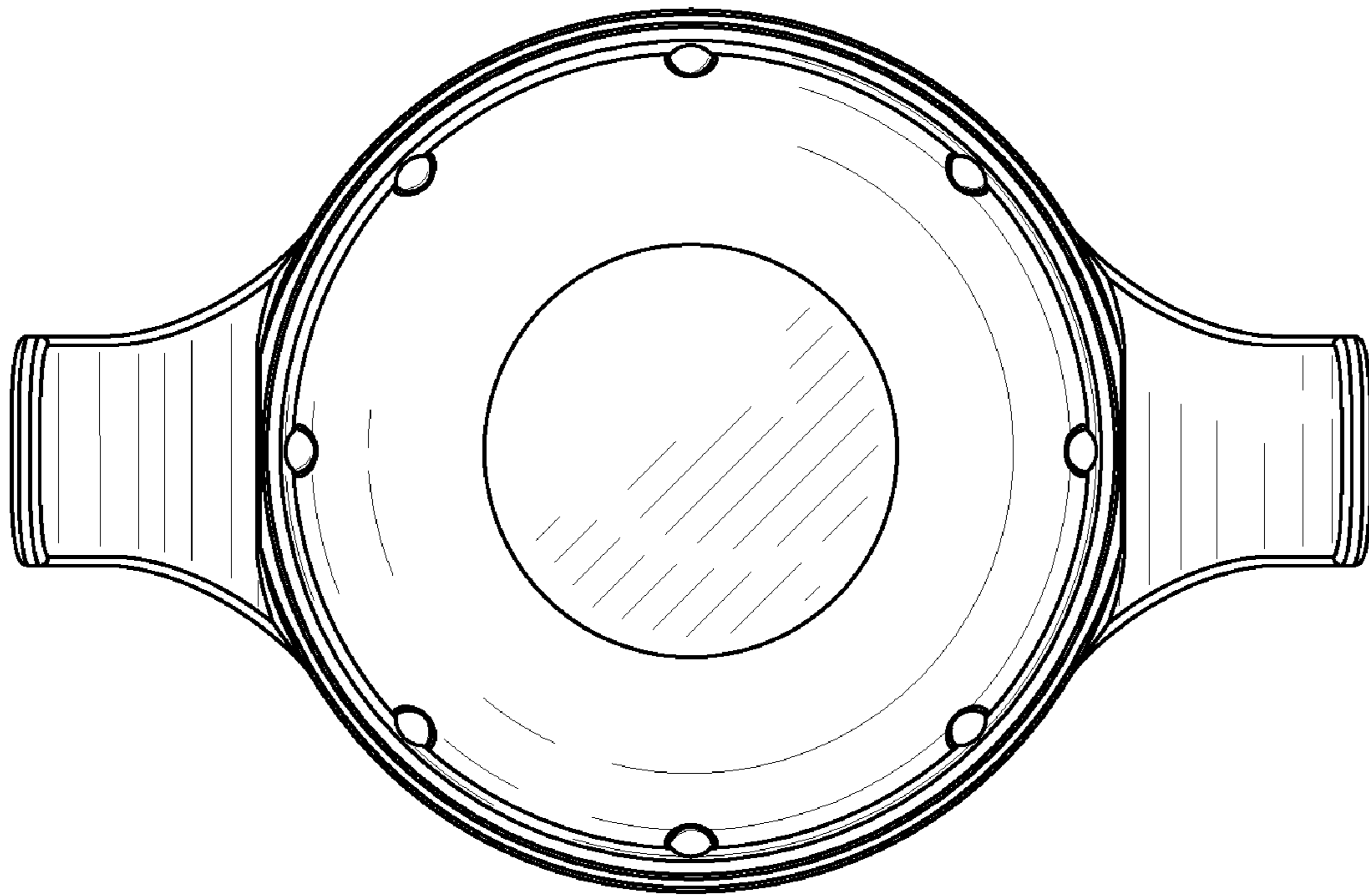

FIG. 7

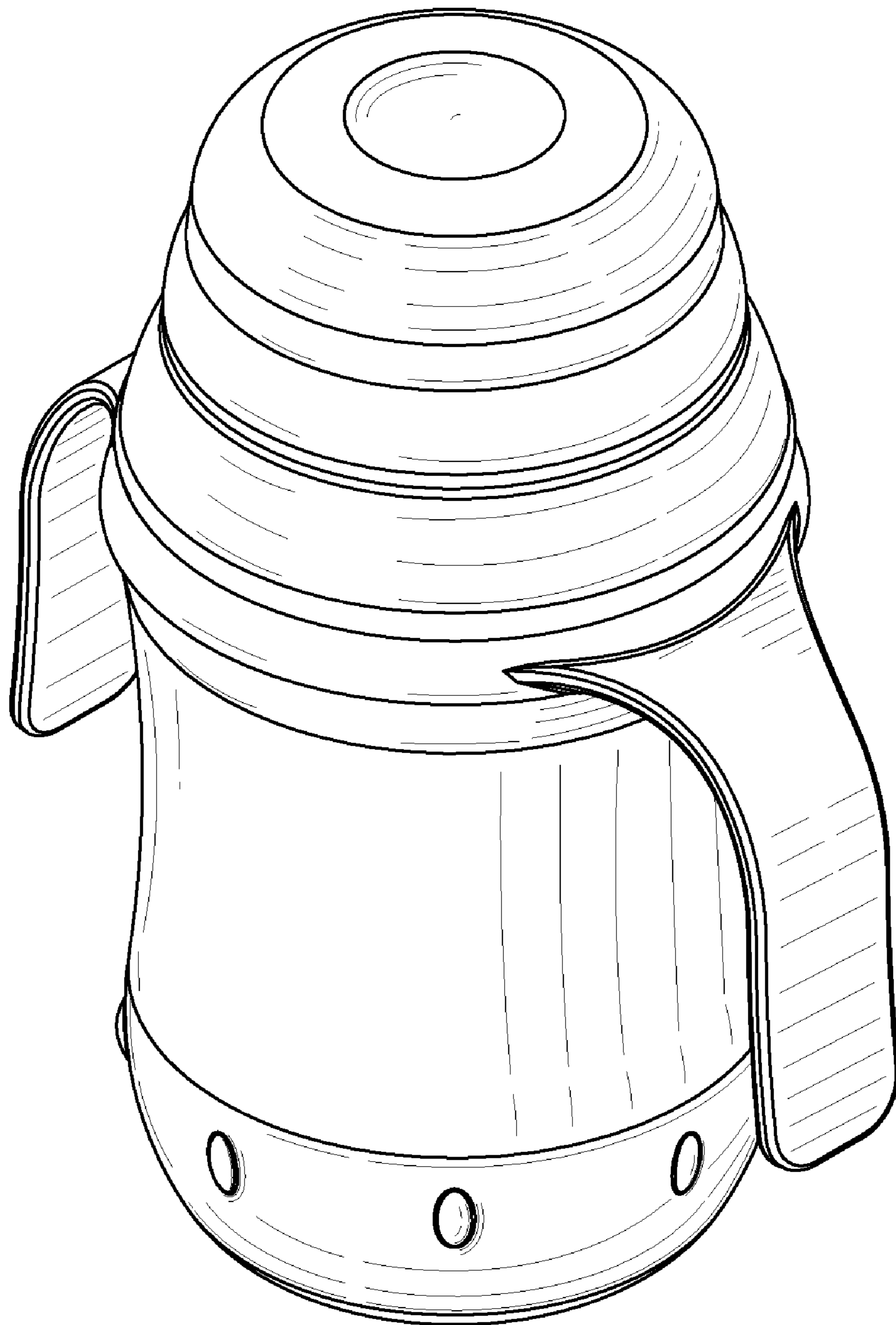

FIG. 8

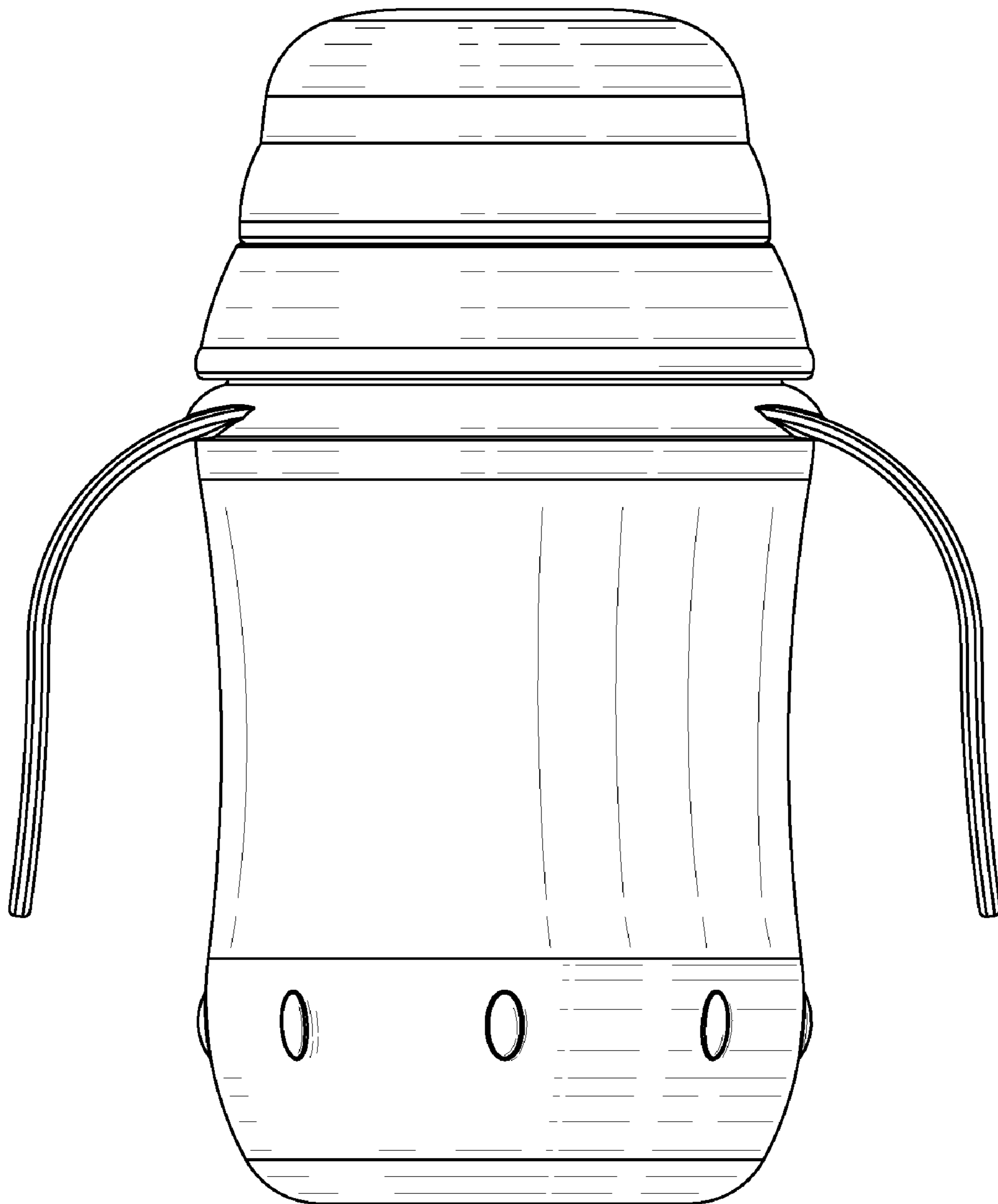

FIG. 9

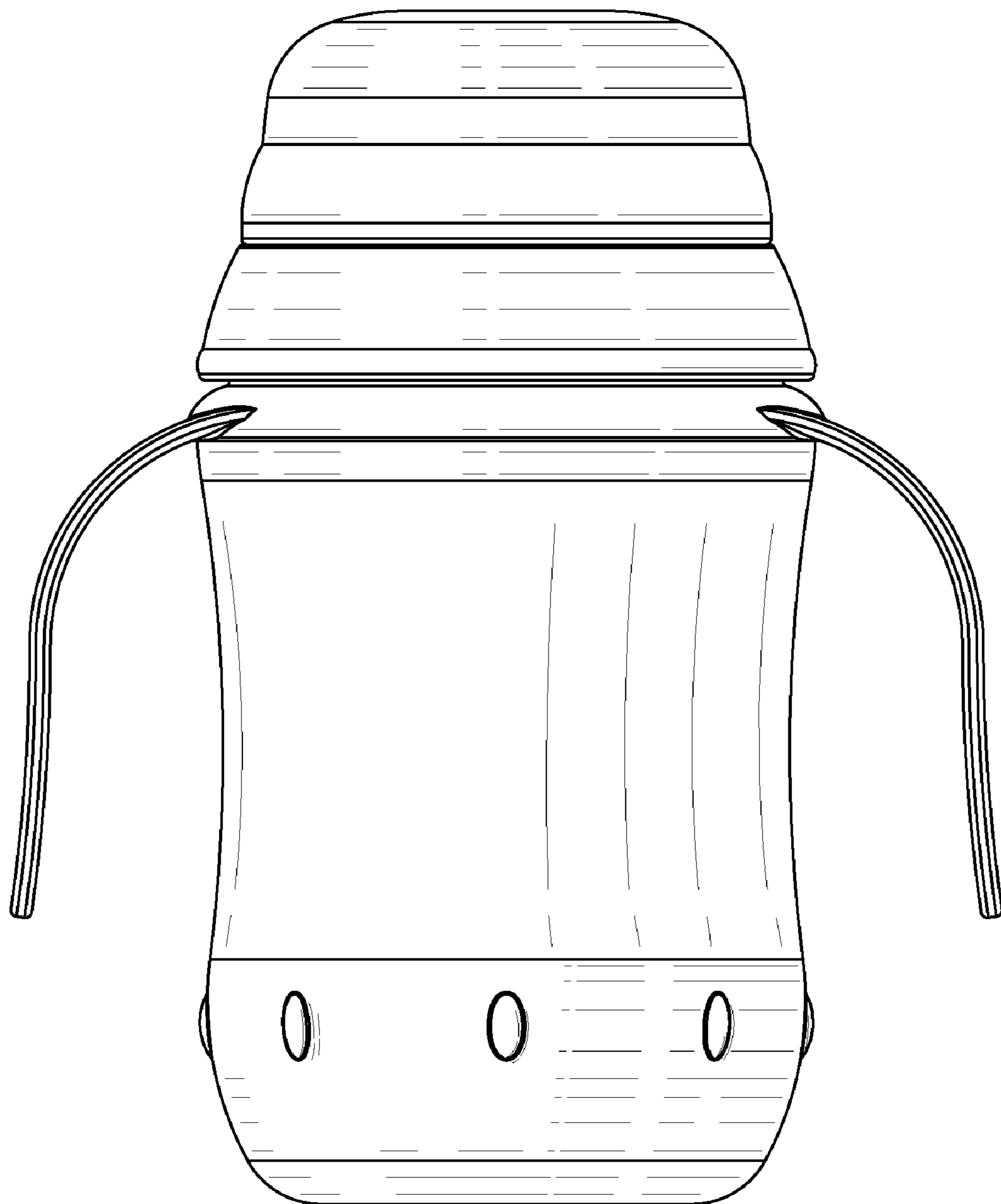

FIG. 10

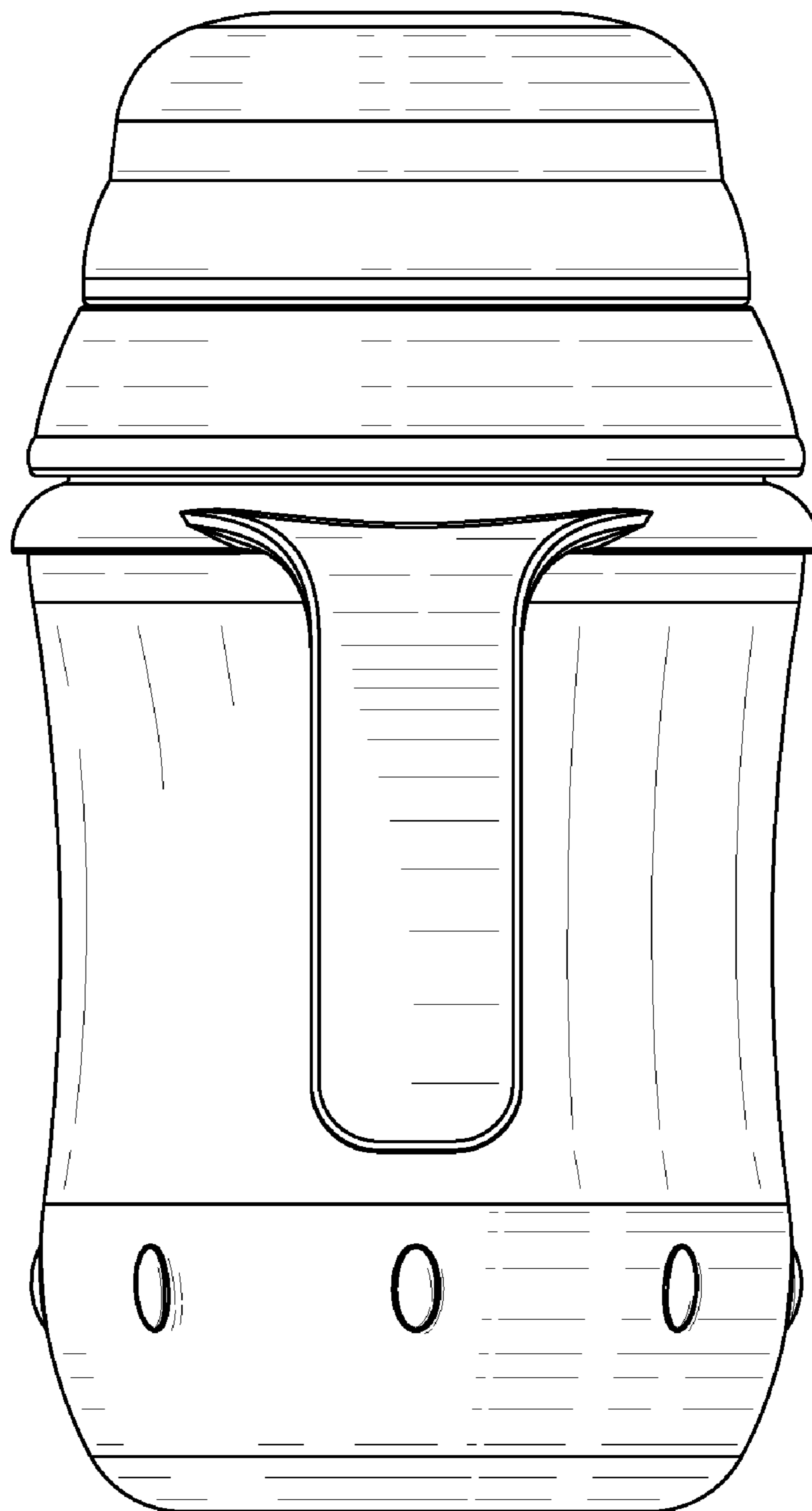

FIG. 11

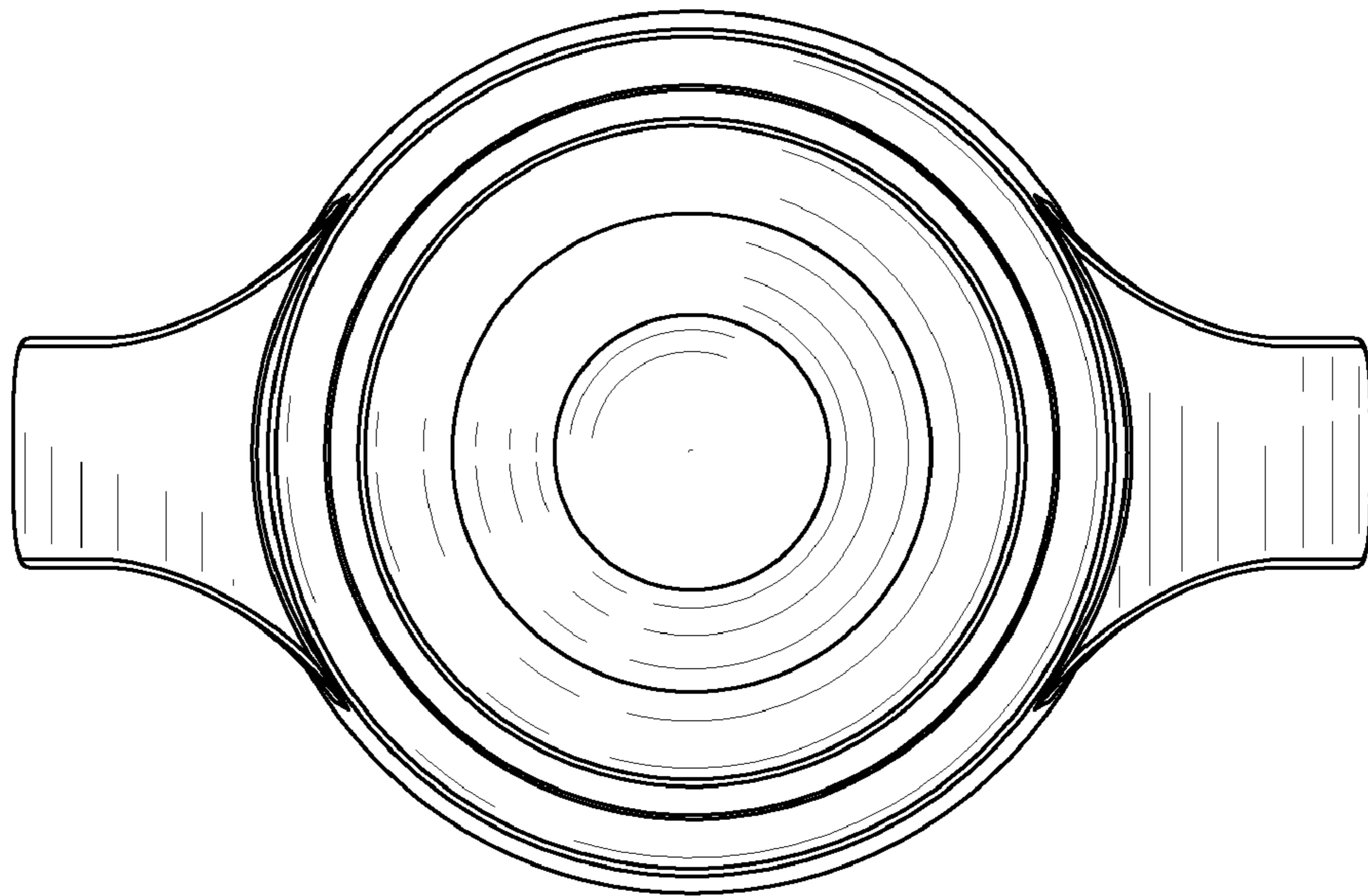

FIG. 12

