



US00D642792S

(12) **United States Design Patent**
Tremblay

(10) **Patent No.:** **US D642,792 S**

(45) **Date of Patent:** **** Aug. 9, 2011**

(54) **GARTER CELL PHONE HOLDER**

(76) Inventor: **Johanne Tremblay**, Pompano Beach, FL (US)

(**) Term: **14 Years**

(21) Appl. No.: **29/367,937**

(22) Filed: **Aug. 16, 2010**

(51) **LOC (9) Cl.** **03-01**

(52) **U.S. Cl.** **D3/218**

(58) **Field of Classification Search** D3/218,
D3/215, 219, 24, 226; D2/627, 631, 639,
D2/625, 612; 224/219, 222, 267, 269, 236,
224/240, 587; 2/308, 312; 455/575.1, 575.2,
455/575.3, 575.4, 575.6; 206/305, 320; 379/455;
D14/138, 250, 253

See application file for complete search history.

(56) **References Cited**

U.S. PATENT DOCUMENTS

1,584,476	A *	5/1926	Schalow	2/308
3,938,720	A *	2/1976	Vela	224/222
D288,743	S *	3/1987	Taylor	D3/226
5,141,141	A *	8/1992	Leone	224/587
D362,540	S *	9/1995	McNamara et al.	D3/215
5,511,702	A *	4/1996	Yang	224/219
5,794,769	A *	8/1998	Tomlinson et al.	224/587
D469,249	S *	1/2003	Cain	D3/215
6,629,628	B1 *	10/2003	Canepari et al.	224/222
D506,059	S *	6/2005	Goldberg	D3/226
7,243,824	B2 *	7/2007	Tabata	224/222

* cited by examiner

Primary Examiner — Catheri Oliver

(74) *Attorney, Agent, or Firm* — QuickPatents, Inc.; Kevin Prince

(57) **CLAIM**

What is claimed is the ornamental design for a garter cell phone holder, as shown and described.

DESCRIPTION

FIG. 1 is a perspective view of a garter cell phone holder, showing a first embodiment of the new design in a worn configuration;

FIG. 2 is a perspective view thereof in a flat configuration;

FIG. 3 is a front elevational view of FIG. 2;

FIG. 4 is a rear elevational view of FIG. 2;

FIG. 5 is a right-side elevational view of FIG. 2;

FIG. 6 is a left-side elevational view of FIG. 2;

FIG. 7 is a top plan view of FIG. 2;

FIG. 8 is a bottom plan view of FIG. 2;

FIG. 9 is a perspective view of a second embodiment of the design, illustrated in the flat configuration; and

FIG. 10 is a front elevational view of FIG. 9, the rear elevational view being identical to FIG. 4.

FIG. 11 is a right-side elevational view of FIG. 9;

FIG. 12 is a left-side elevational view of FIG. 9;

FIG. 13 is a top plan view of FIG. 9; and,

FIG. 14 is a bottom plan view of FIG. 9.

The broken lines showing a person in FIG. 1 are included for the purpose of illustrating the invention in use, and form no part of the claimed design.

1 Claim, 6 Drawing Sheets

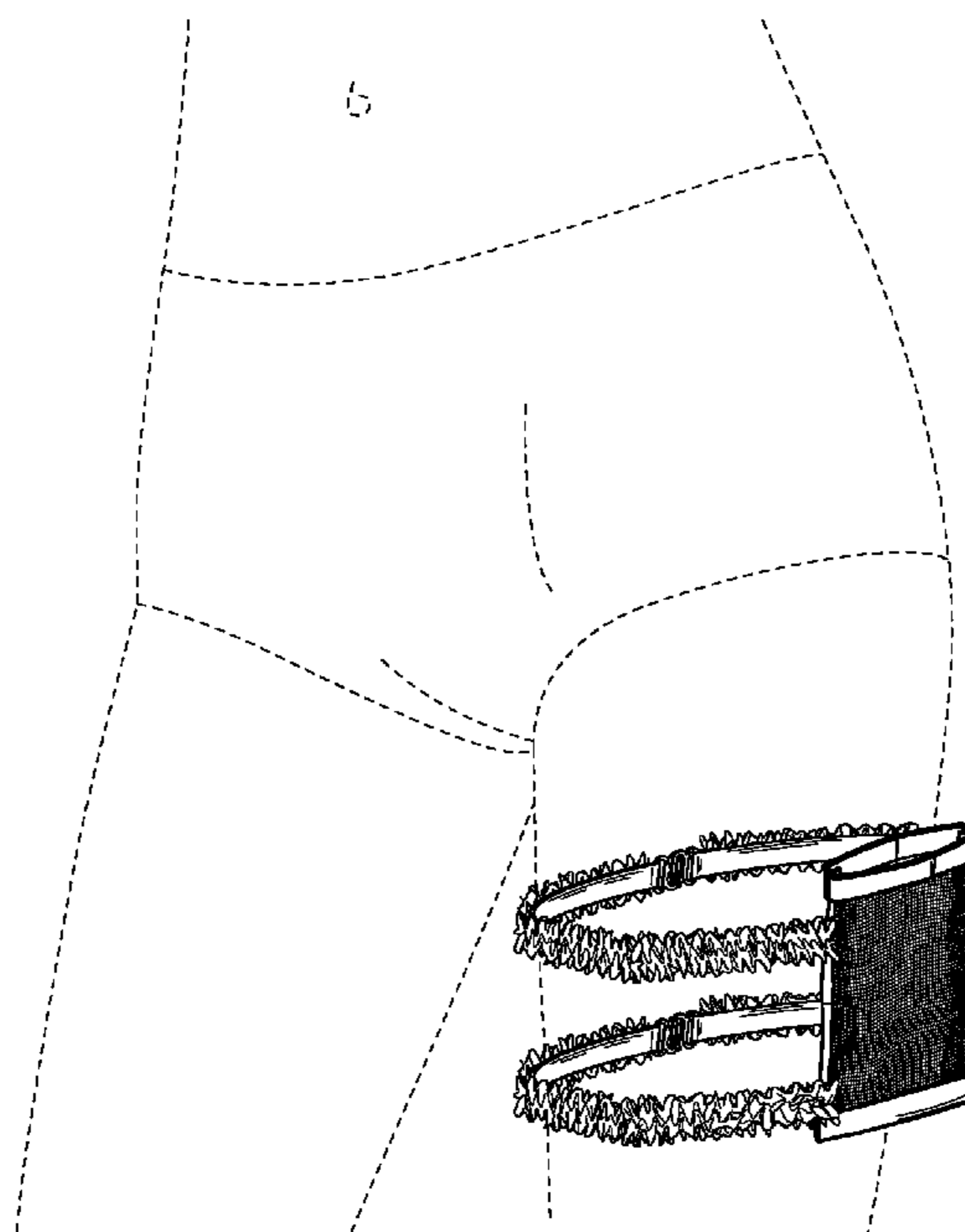

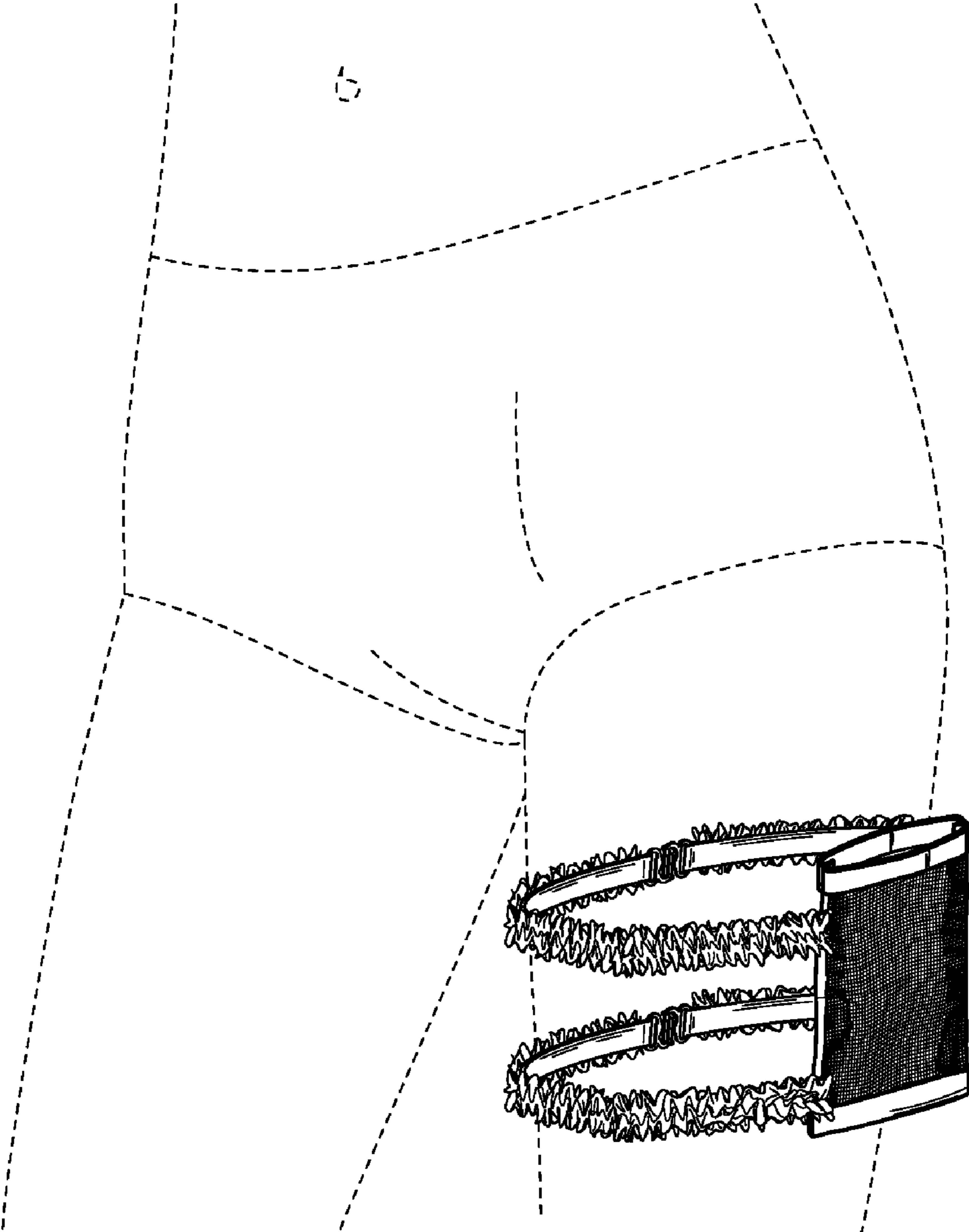

FIG. 1

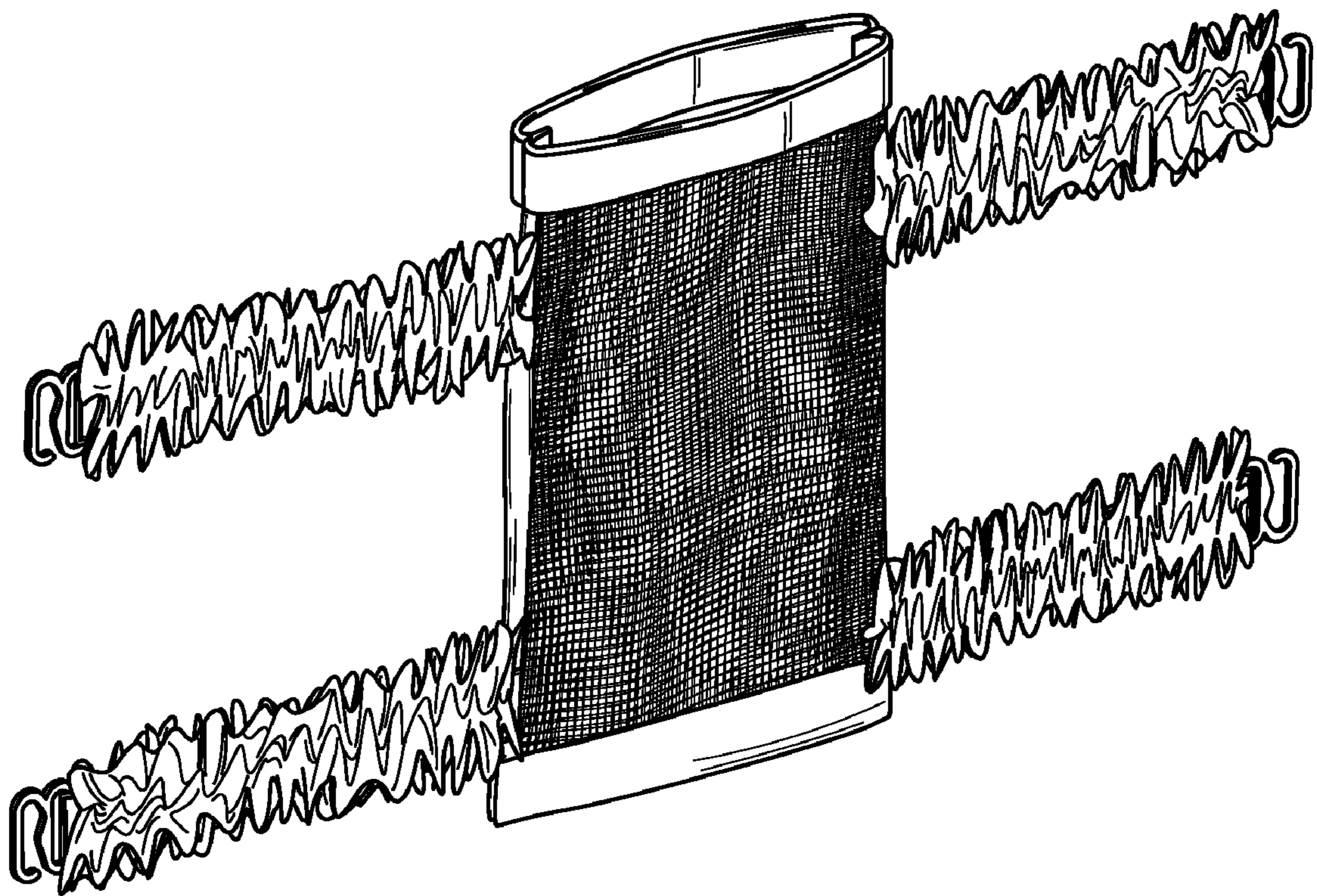

FIG. 2

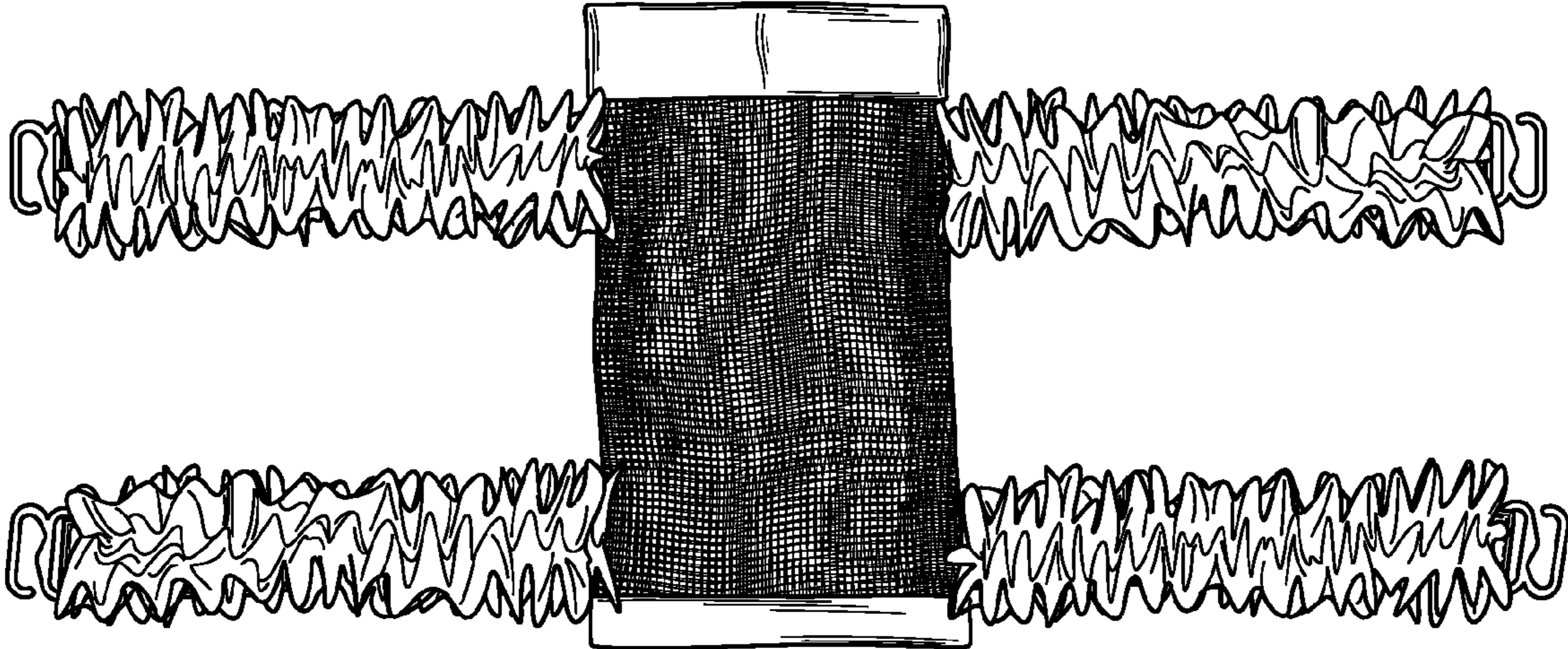

FIG. 3

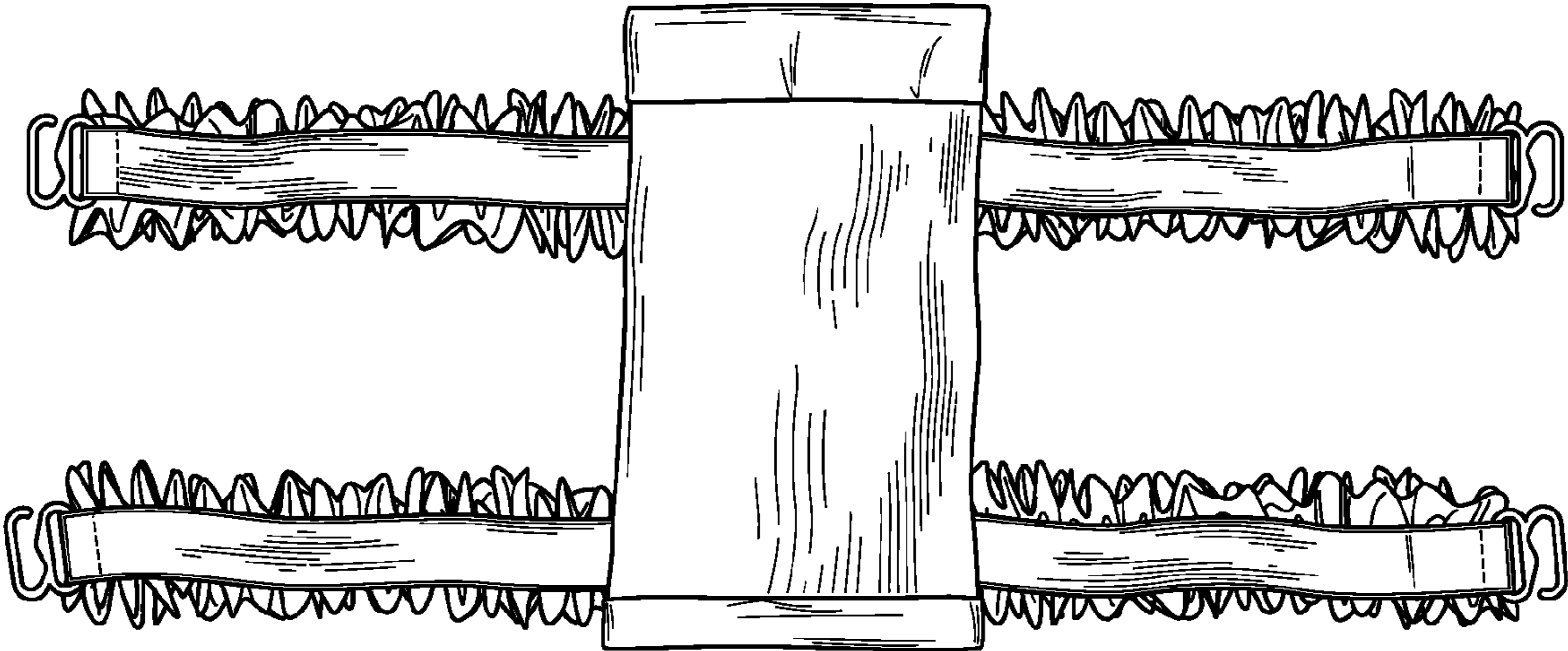

FIG. 4

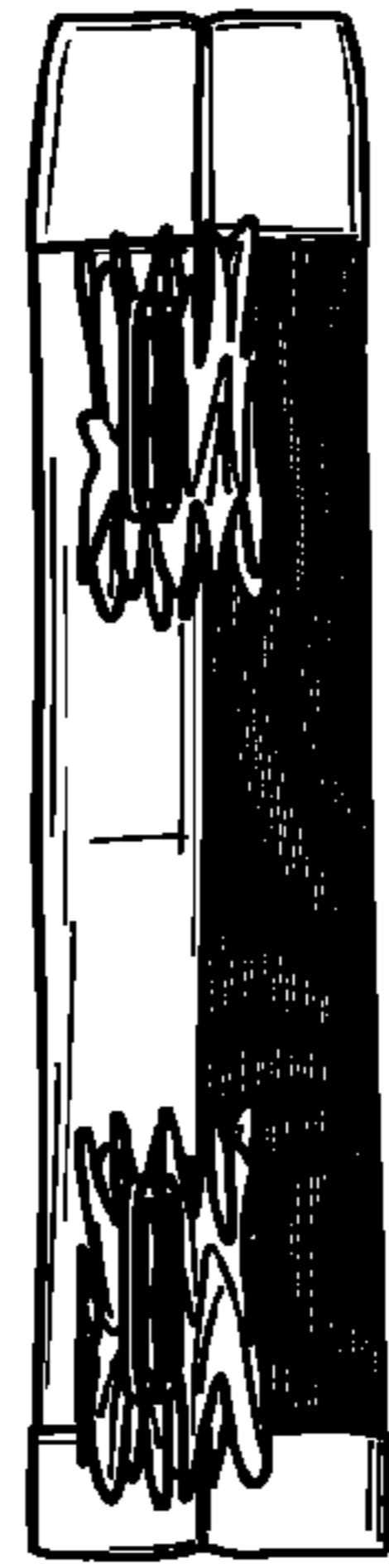

FIG. 5

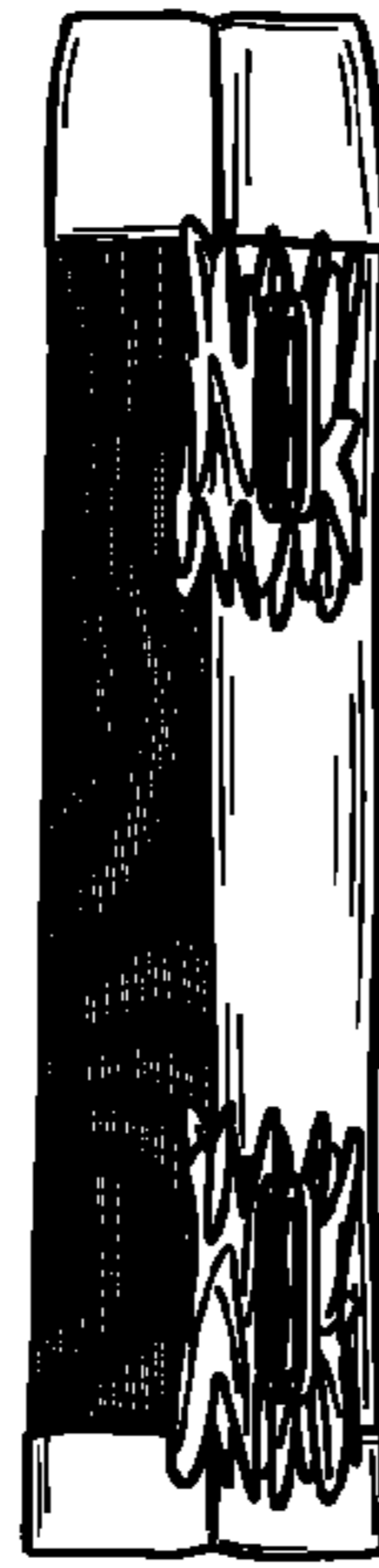

FIG. 6

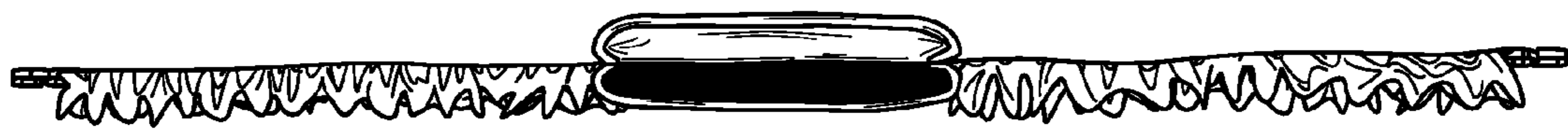

FIG. 7

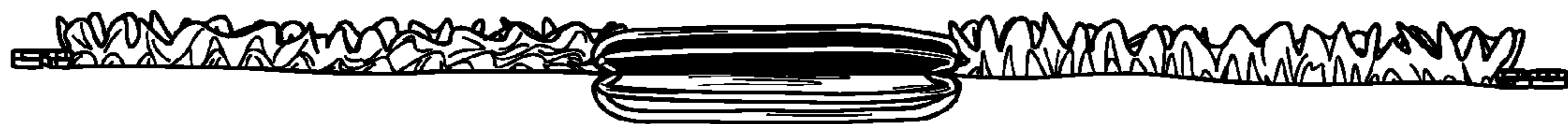

FIG. 8

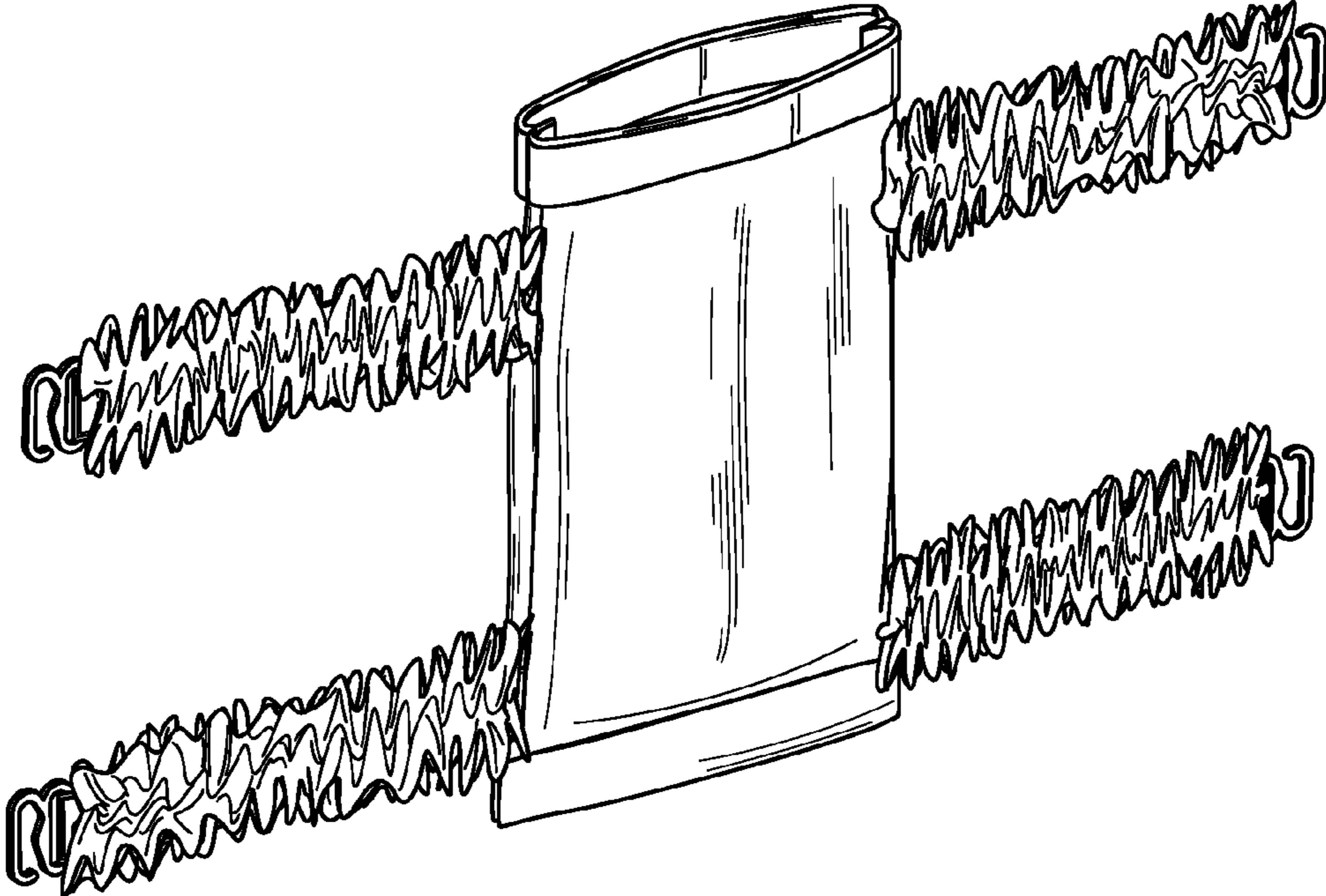

FIG. 9

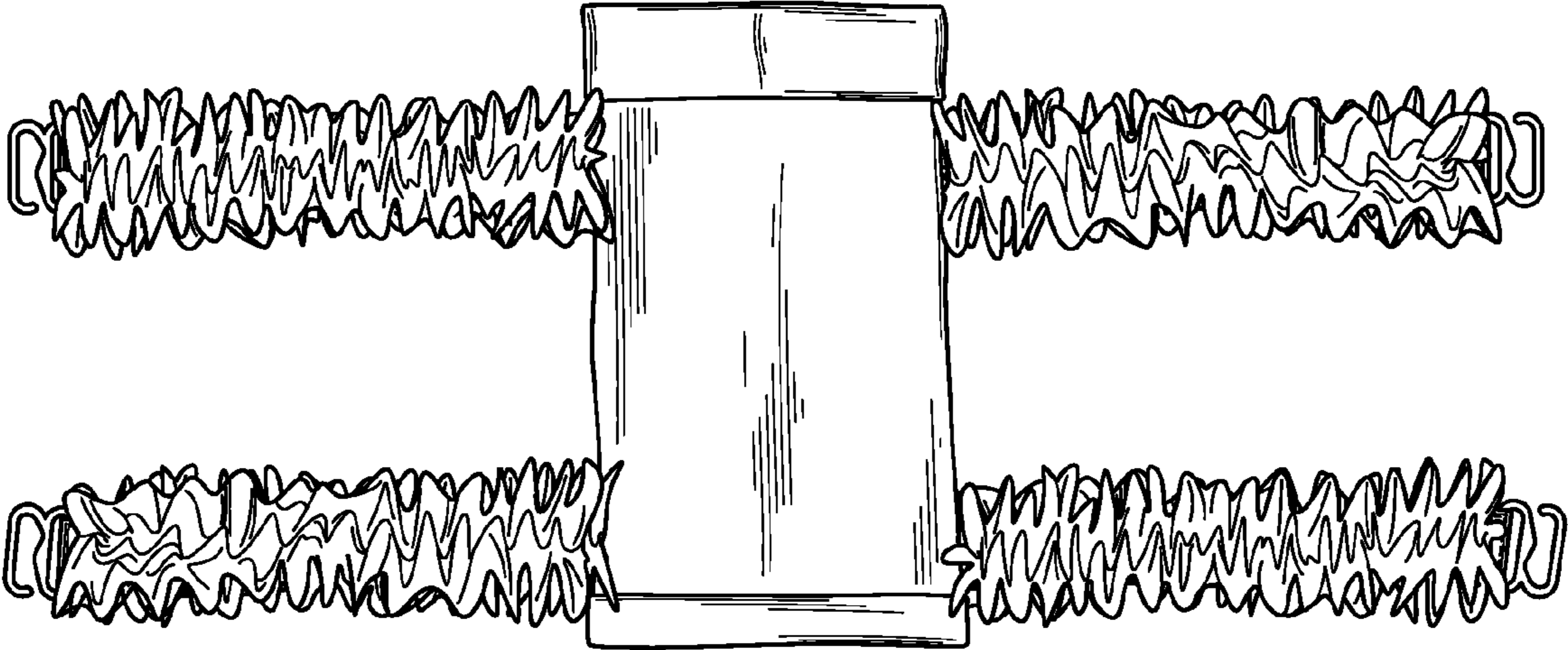

FIG. 10

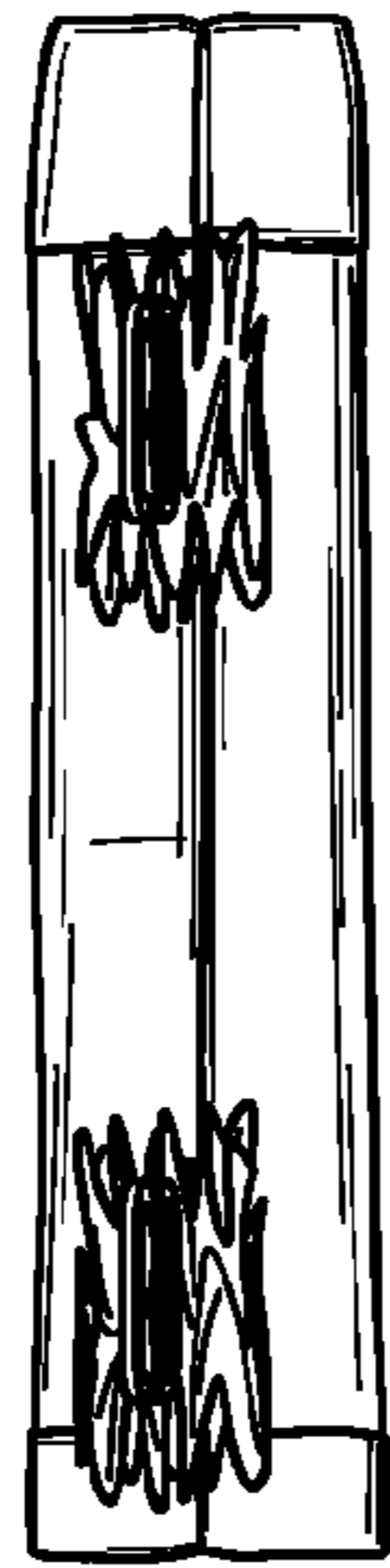

FIG. 11



FIG. 12

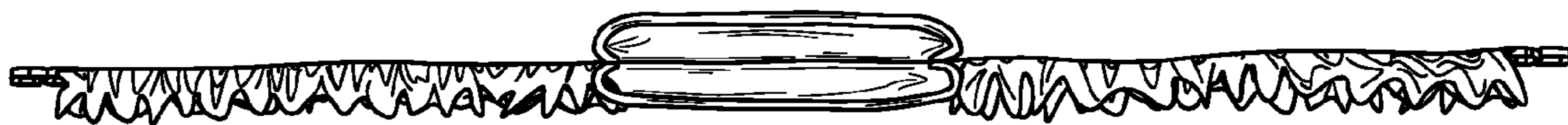

FIG. 13

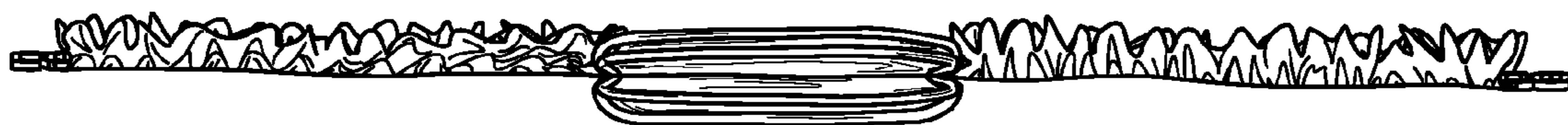

FIG. 14