



US00D642585S

(12) **United States Design Patent**  
**Lan et al.**

(10) **Patent No.:** **US D642,585 S**

(45) **Date of Patent:** **\*\* Aug. 2, 2011**

(54) **NETWORK ADAPTER**

(75) Inventors: **Dezheng Lan**, Shanghai (CN);  
**Shih-Chin Tseng**, Shanghai (CN)

(73) Assignees: **Inventec Appliances (Shanghai) Co., Ltd.**, Shanghai (CN); **Inventec Appliances Corp.**, Taipei Hsien (TW)

(\*\*) Term: **14 Years**

(21) Appl. No.: **29/359,220**

(22) Filed: **Apr. 7, 2010**

(30) **Foreign Application Priority Data**

Oct. 13, 2009 (CN) ..... 2009 3 0228648

(51) **LOC (9) Cl.** ..... **14-02**

(52) **U.S. Cl.** ..... **D14/480.5**

(58) **Field of Classification Search** ..... D14/411,  
D14/433, 435.1, 436, 480.1–480.7, 484.1,  
D14/137, 155, 203.1–203.8, 240; D3/201,  
D3/273; D13/107, 108, 133, 154, 184; 710/300,  
710/301; 439/131, 135–147; 361/379.31,  
361/679.33, 679.4, 752; 711/100, 115  
See application file for complete search history.

(56) **References Cited**

**U.S. PATENT DOCUMENTS**

D104,711 S *	5/1937	Weston	.....	D13/103
D317,310 S *	6/1991	Schwartz	.....	D14/218
D449,615 S *	10/2001	Lloyd	.....	D14/435.1
D463,426 S *	9/2002	Cheng	.....	D14/480.1
D492,307 S *	6/2004	Aqqad et al.	.....	D14/480.5
6,758,689 B1 *	7/2004	Bair et al.	.....	439/136
D496,364 S *	9/2004	Saito	.....	D14/385
D500,302 S *	12/2004	Deguchi	.....	D14/480.4
D506,471 S *	6/2005	Iikura et al.	.....	D14/480.5
D511,770 S *	11/2005	Chung	.....	D14/480.5
D525,247 S *	7/2006	Rubin et al.	.....	D14/480.2
D527,734 S *	9/2006	Lee et al.	.....	D14/480.5

D530,340 S *	10/2006	Andre et al.	.....	D14/203.3
D531,118 S *	10/2006	Krieger et al.	.....	D14/435.1
D531,190 S *	10/2006	Lee et al.	.....	D14/203.3
D538,297 S *	3/2007	Ching	.....	D14/203.3
D539,813 S *	4/2007	Chen	.....	D14/203.3
D541,796 S *	5/2007	Chen	.....	D14/480.7
D542,787 S *	5/2007	Siu	.....	D14/480.5

(Continued)

**OTHER PUBLICATIONS**

USB—SlashGear: The key to safer data storage?, p. 6 [online] posted Jan. 29, 2007 [retrieved on Nov. 14, 2007]. Retrieved from the Internet <URL: <http://www.slashgear.com/tags/USB/page/14>>.\*

(Continued)

*Primary Examiner* — Cathron Brooks

*Assistant Examiner* — Karen E Kearney

(74) *Attorney, Agent, or Firm* — McDermott Will & Emery LLP

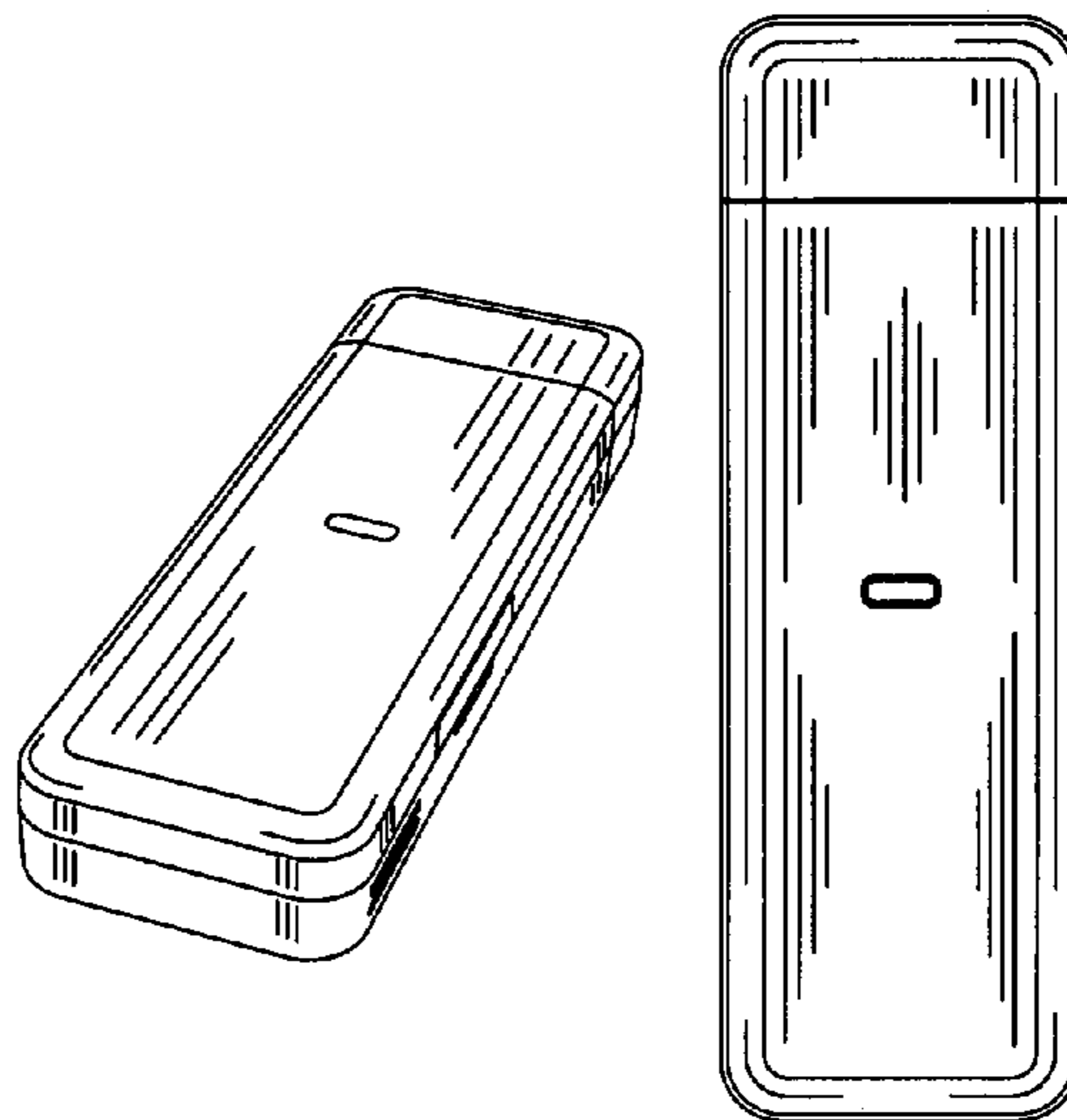
(57) **CLAIM**

The ornamental design for a network adapter, as shown and described.

**DESCRIPTION**

FIG. 1 is a front perspective view of the network adapter in an assembled form, showing the new design; FIG. 2 is a front view of the network adapter; FIG. 3 is a rear view of the network adapter; FIG. 4 is a side view of the network adapter; FIG. 5 is another side view of the network adapter; FIG. 6 is a bottom view of the network adapter; FIG. 7 is a top view of the network adapter; FIG. 8 is an exploded perspective view of the network adapter wherein an adapter cap is detached from a body of the network adapter; FIG. 9 is an exploded rear view of the network adapter; and, FIG. 10 is an exploded view of the network adapter corresponding to the side view in FIG. 4.

**1 Claim, 6 Drawing Sheets**



U.S. PATENT DOCUMENTS

D542,788	S *	5/2007	Gutmann et al.	.....	D14/480.5
D544,479	S *	6/2007	Chen	.....	D14/480.4
D555,158	S *	11/2007	Lo	.....	D14/480.5
D577,715	S *	9/2008	Lim et al.	.....	D14/240
D583,816	S *	12/2008	Guccione et al.	.....	D14/480.5
D588,611	S *	3/2009	Oh et al.	.....	D14/496
7,503,780	B1 *	3/2009	Huang	.....	439/135
D597,068	S *	7/2009	Whang	.....	D14/203.7
D609,712	S *	2/2010	Bedol	.....	D14/480.5
D610,134	S *	2/2010	Gotzen	.....	D14/480.5
D610,156	S *	2/2010	Mudrick	.....	D14/480.5
7,679,008	B2 *	3/2010	Lee	.....	174/560
D624,924	S *	10/2010	Lee	.....	D14/480.5
D631,055	S *	1/2011	Gilbert et al.	.....	D14/480.5
2009/0316368	A1 *	12/2009	Hiew et al.	.....	361/737

OTHER PUBLICATIONS

A-DATA Technology, p. 2 [online], [retrieved on Jul. 3, 2007].

Retrieved from the Internet <URL: [http://www.adata.com.tw/adata\\_en/products\\_search.php](http://www.adata.com.tw/adata_en/products_search.php)>.\*

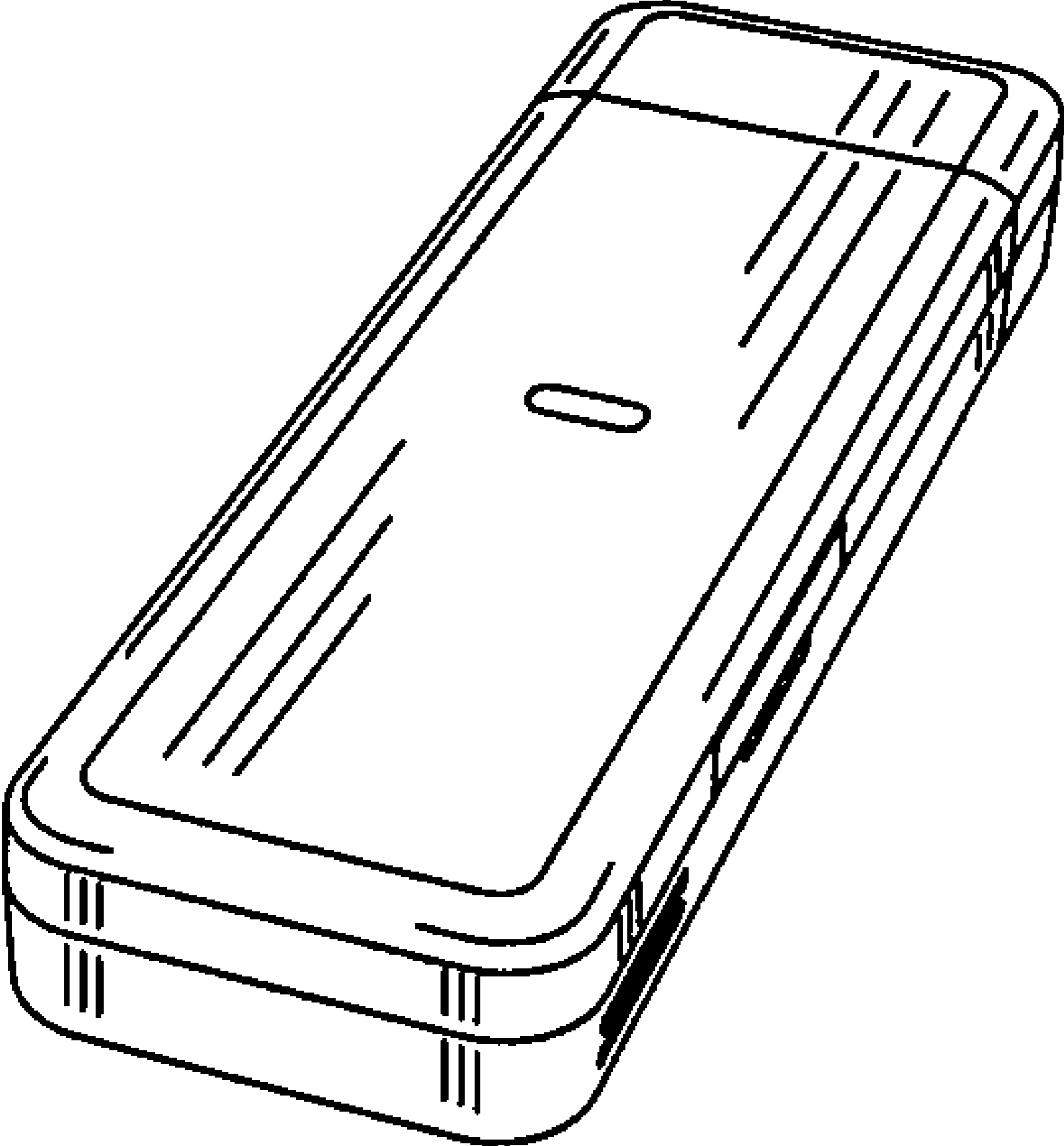
Drone—Plug & Play 100-meter range Bluetooth VOIP and Music for your PC, [online], [retrieved on Oct. 14, 2008]. Retrieved from the Internet <URL: <http://www.callpod.com/products/drone>>.\*

A-DATA flash drive, Web Archive [online] Dec. 1, 2005 [retrieved on Dec. 13, 2006]. Retrieved from the Internet <URL: [http://web.archive.org/web/20051201015403/http://www.frontier-electronics.co.za/images/sdp\\_adata\\_flash\\_drive.jpg](http://web.archive.org/web/20051201015403/http://www.frontier-electronics.co.za/images/sdp_adata_flash_drive.jpg)>.\*

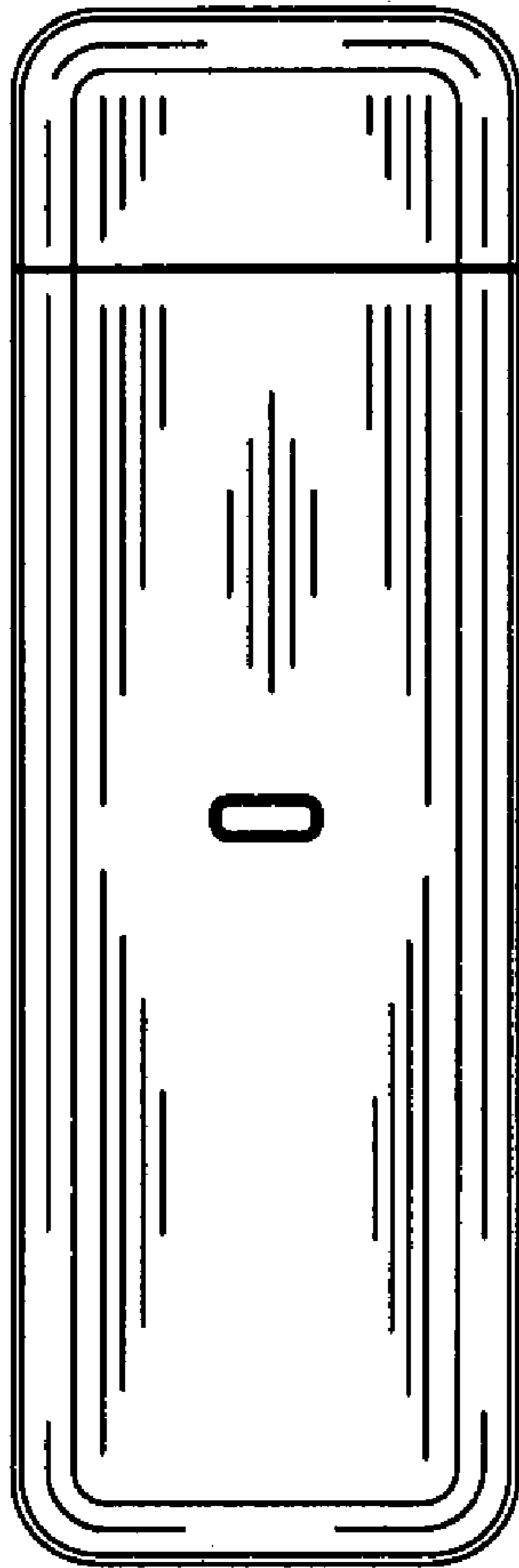
A-data, Imation, Kingston, Pretec  $\mu$  Toshiba, Web Archive, p. 9 [online] Feb. 8, 2006 [retrieved on Dec. 4, 2006]. Retrieved from the Internet <URL: <http://web.archive.org/web/20060208032439/http://www.ixbt.com/storage/flashdrivesp-16.shtml>>.\*

Laptoplog >> Usb, p. 7 [online] posted on Jan. 3, 2006 [retrieved on Jan. 30, 2007]. Retrieved from the Internet <URL: <http://www.laptoplog.com/category/accesorios/usb/>>.\*

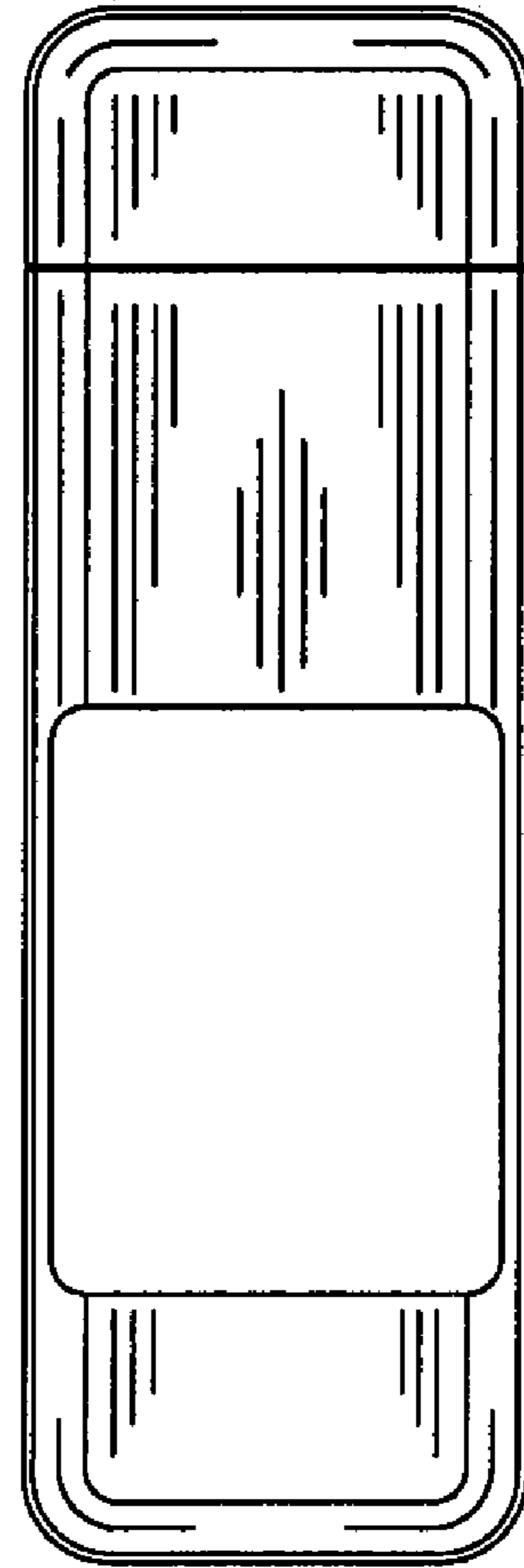
\* cited by examiner



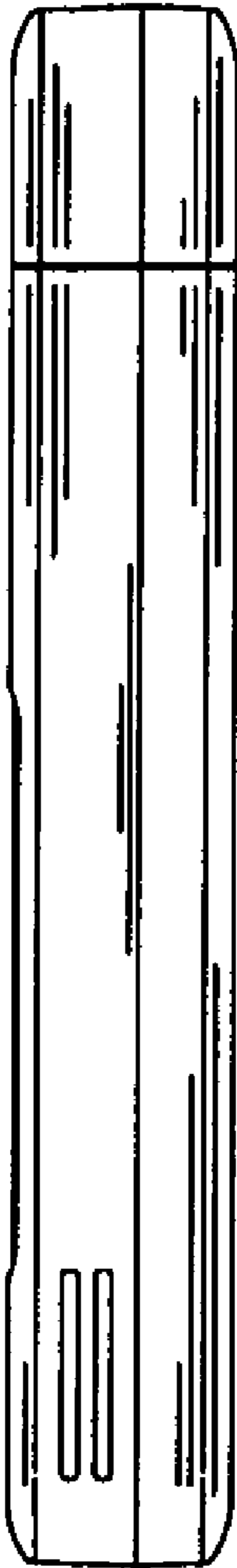
**FIG. 1**



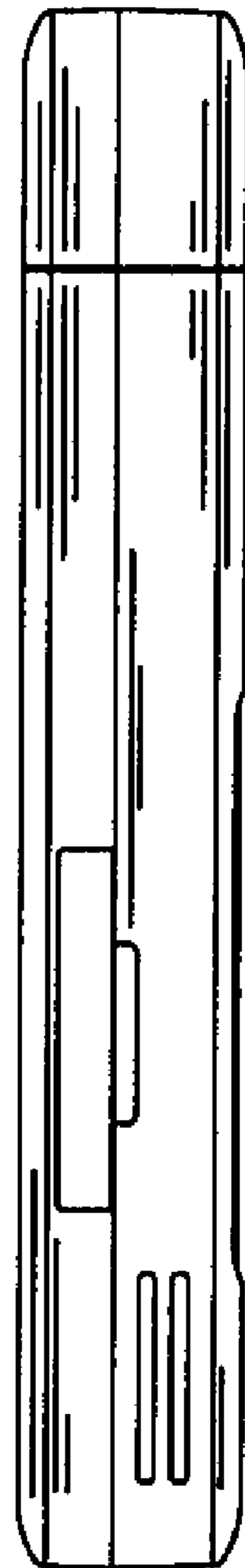
**FIG. 2**



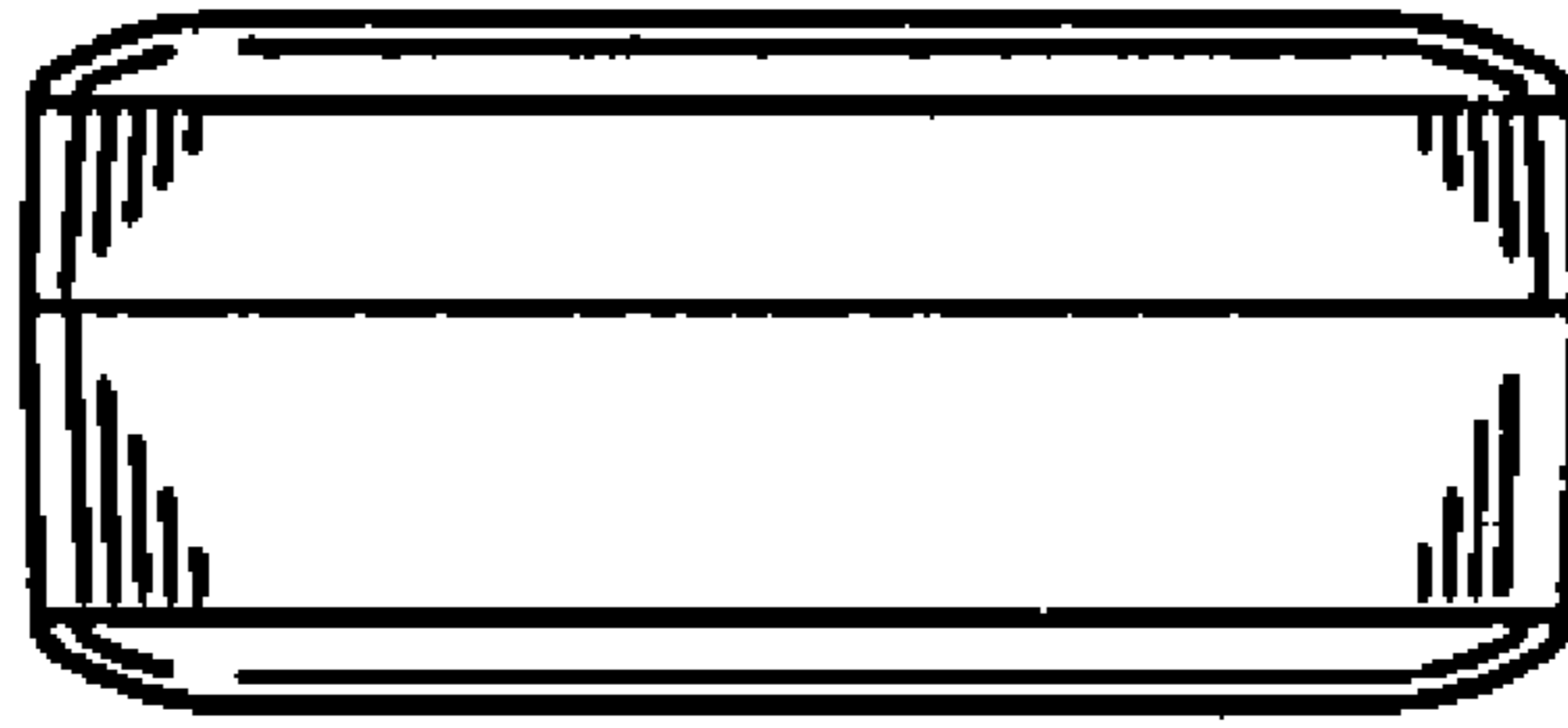
**FIG. 3**



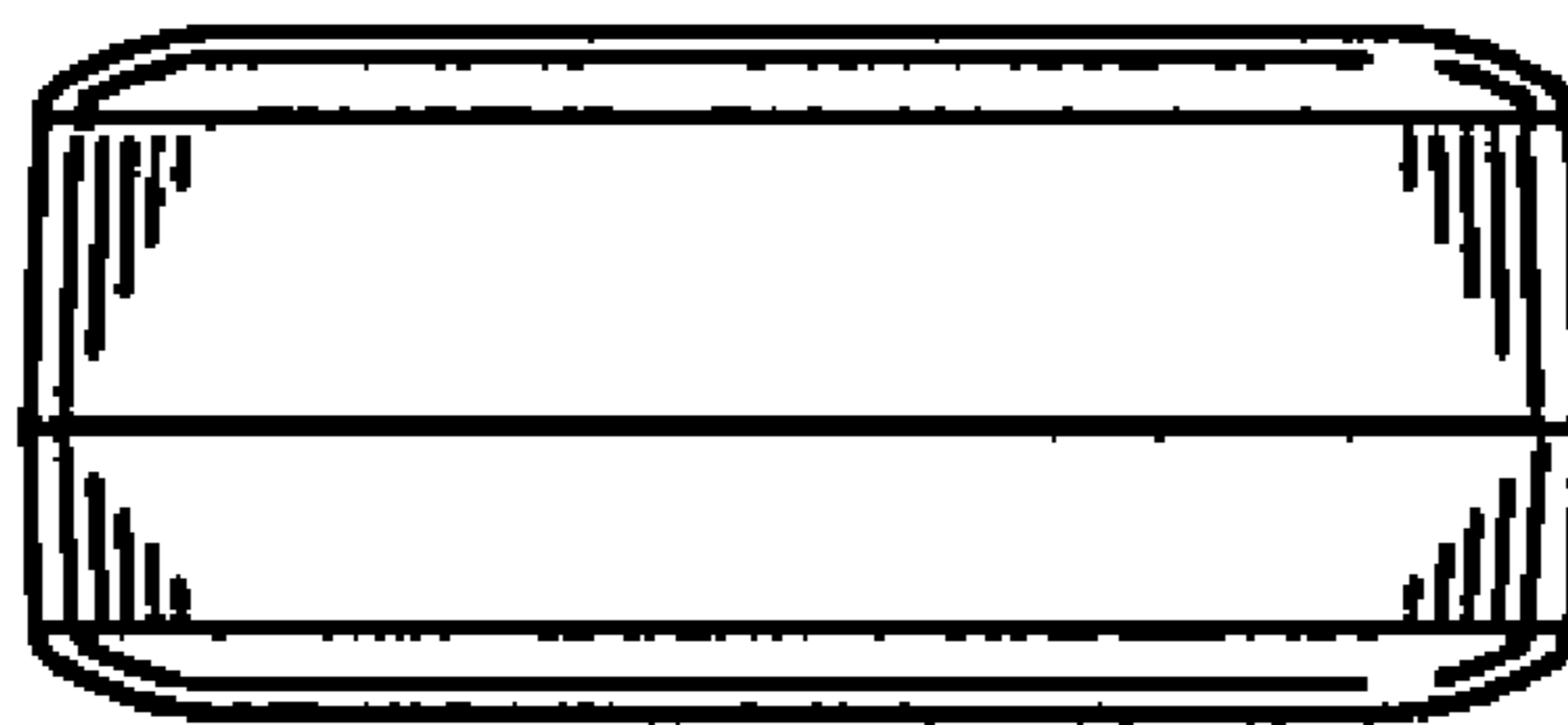
**FIG. 4**



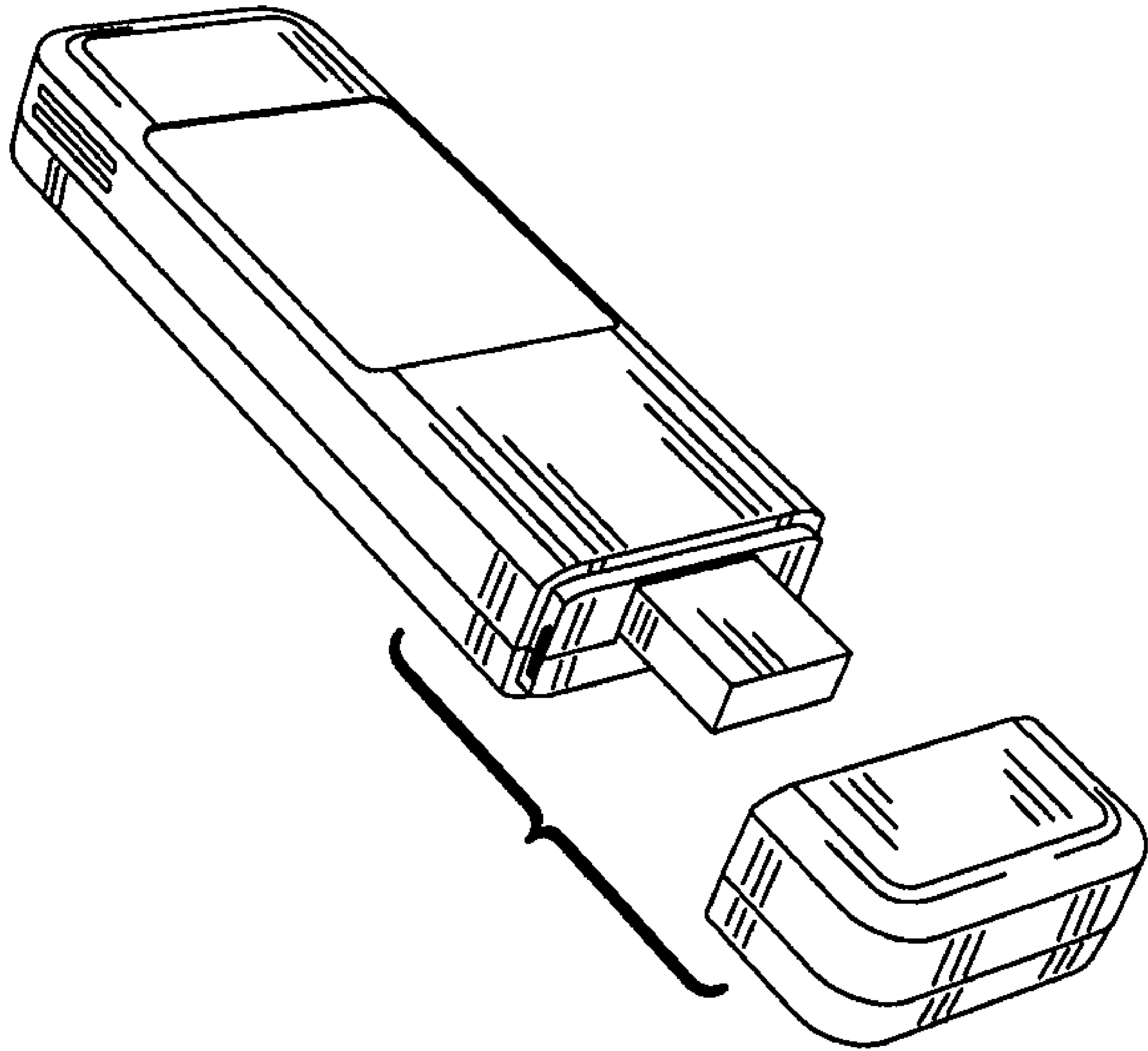
**FIG. 5**



**FIG. 6**

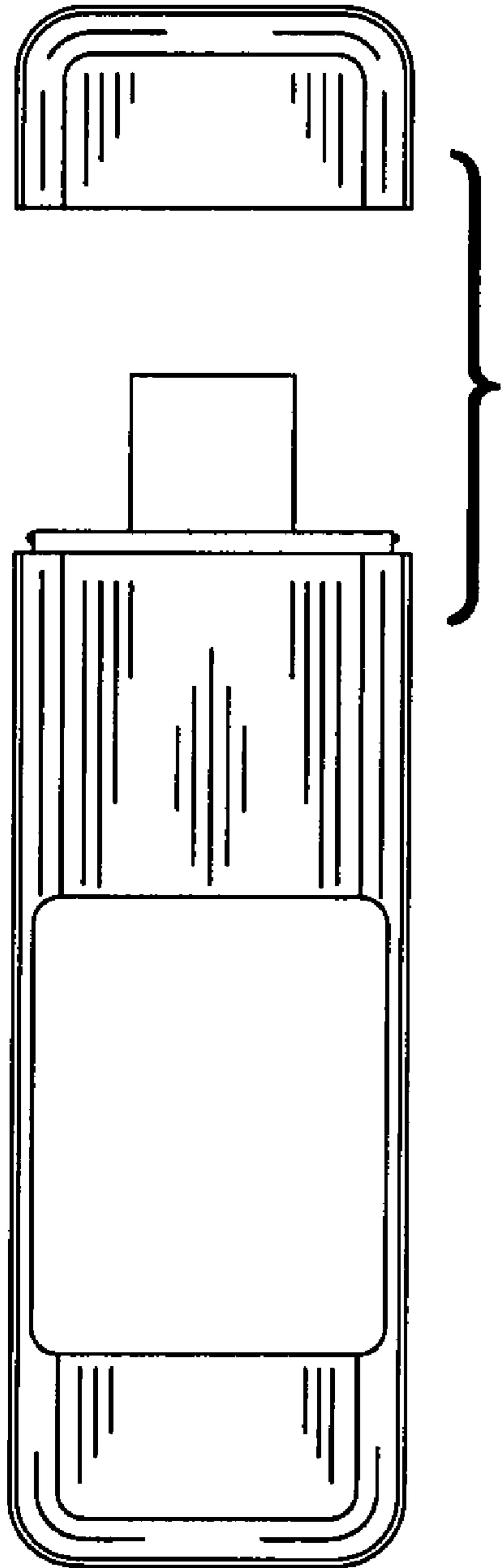


**FIG. 7**



**FIG. 8**





**FIG. 9**



**FIG. 10**