



US00D642573S

(12) **United States Design Patent**
Kujawski

(10) **Patent No.:** **US D642,573 S**
(45) **Date of Patent:** **** Aug. 2, 2011**

(54) **ELECTRONIC MOUSE WITH ORNAMENTATION**

(75) Inventor: **Christopher Kujawski**, Seattle, WA (US)

(73) Assignee: **Microsoft Corporation**, Redmond, WA (US)

(**) Term: **14 Years**

(21) Appl. No.: **29/385,842**

(22) Filed: **Feb. 21, 2011**

(51) **LOC (9) Cl.** **14-02**

(52) **U.S. Cl.** **D14/402**

(58) **Field of Classification Search** D14/402-411,
D14/356, 388, 389, 383-385, 417, 426;
345/156-167; 463/36-38; 358/471, 473;
273/148 B

See application file for complete search history.

(56) **References Cited**

U.S. PATENT DOCUMENTS

D479,843 S *	9/2003	Mori	D14/408
D580,938 S *	11/2008	Simonian et al.	D14/402
D581,416 S *	11/2008	Simonian et al.	D14/402
D591,748 S *	5/2009	Hu et al.	D14/402
D593,096 S *	5/2009	Bolotin et al.	D14/402
D595,296 S *	6/2009	Chatterjee et al.	D14/402
D596,181 S *	7/2009	Bolotin et al.	D14/406
D607,455 S *	1/2010	Reed et al.	D14/408
D607,456 S *	1/2010	Reed et al.	D14/408
D616,443 S	5/2010	Chatterjee et al.		
D616,444 S *	5/2010	Lacotta et al.	D14/402
D616,887 S *	6/2010	Le Guen et al.	D14/407
D617,324 S *	6/2010	Fang et al.	D14/402
D629,804 S *	12/2010	Hoehn et al.	D14/408

FOREIGN PATENT DOCUMENTS

EM	001193999	4/2010
EM	001230627	9/2010

OTHER PUBLICATIONS

“Design and Evaluation of Interaction Models for Multi-touch Mice”. In Proceedings of Graphics Interface 2010. pp. 253-260, dated 2010.

Belkin Washable Mouse, <http://www.gadgetgrid.com/2008/04/16/belkin-washable-mouse/> dated Apr. 16, 2008, accessed Feb. 21, 2011.

* cited by examiner

Primary Examiner — Austin Murphy

(74) *Attorney, Agent, or Firm* — Banner & Witcoff, Ltd.

(57) **CLAIM**

The ornamental design for an electronic mouse with ornamentation, as shown and described.

DESCRIPTION

FIG. 1 is a perspective view of an electronic mouse with ornamentation showing the new design;

FIG. 2 is a top view thereof;

FIG. 3 is a left side view thereof;

FIG. 4 is a right side view thereof;

FIG. 5 is a front view thereof;

FIG. 6 is a rear view thereof;

FIG. 7 is a bottom view thereof;

FIG. 8 is a perspective view of an electronic mouse with ornamentation showing an alternative embodiment of the new design;

FIG. 9 is a top view thereof;

FIG. 10 is a left side view thereof;

FIG. 11 is a right side view thereof;

FIG. 12 is a front view thereof;

FIG. 13 is a rear view thereof;

FIG. 14 is a bottom view thereof;

FIG. 15 is a perspective view of an electronic mouse with ornamentation showing a second alternative embodiment of the new design;

FIG. 16 is a top view thereof;

FIG. 17 is a left side view thereof;

FIG. 18 is a right side view thereof;

FIG. 19 is a front view thereof;

FIG. 20 is a rear view thereof; and,

FIG. 21 is a bottom view thereof.

The broken lines shown in the drawings represent portions of the electronic mouse with ornamentation that form no part of the claimed design.

1 Claim, 15 Drawing Sheets

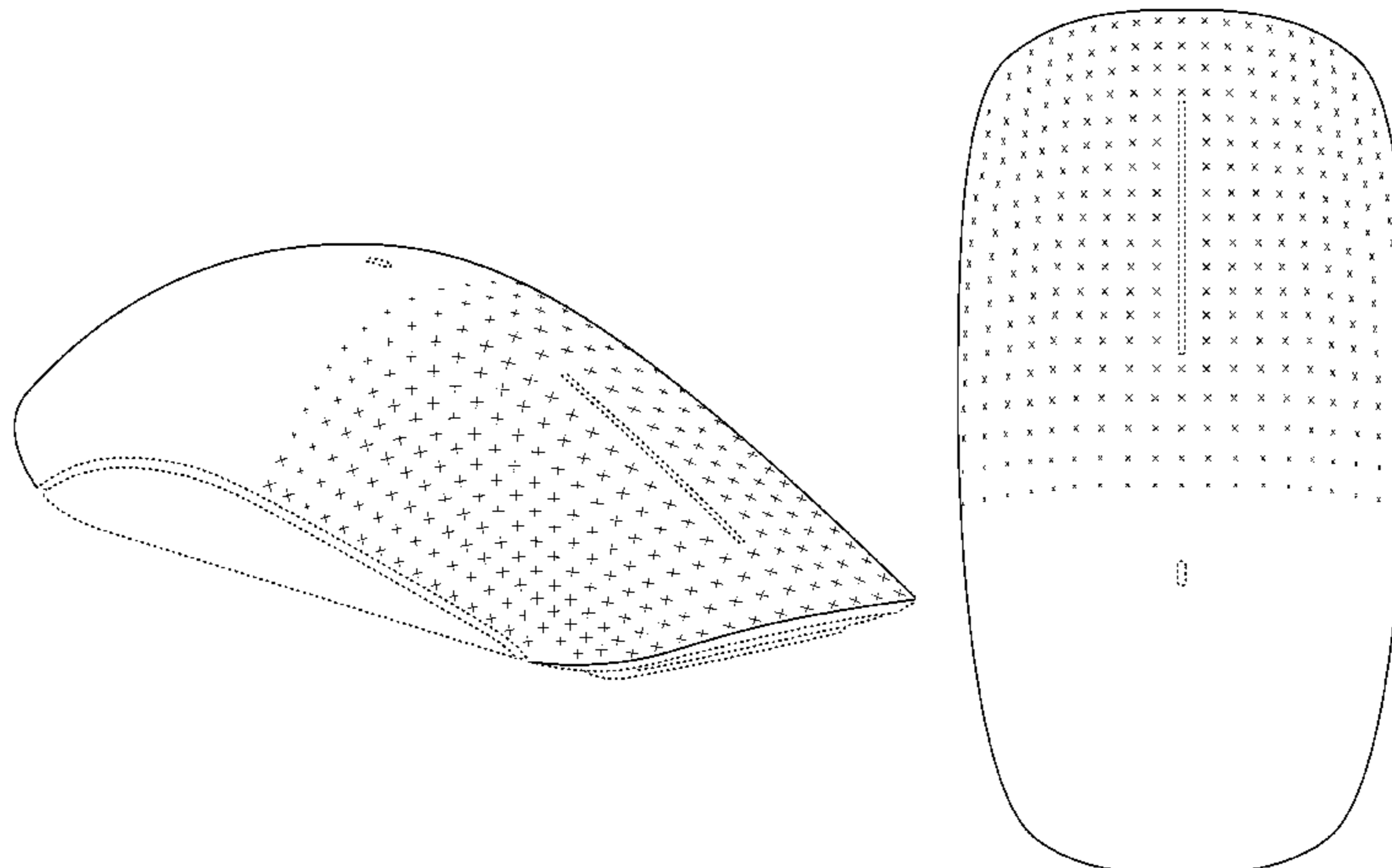

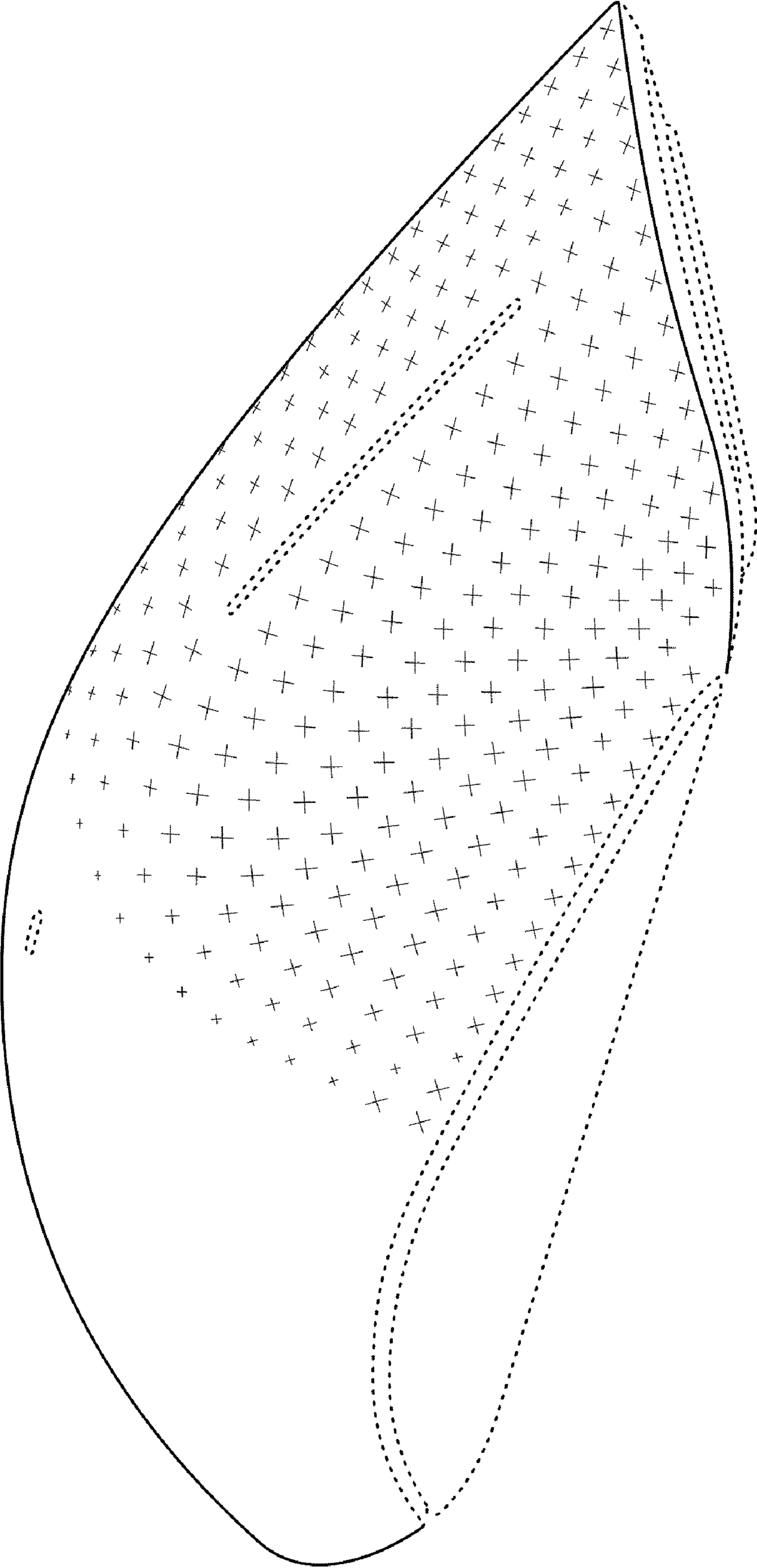

FIG. 1

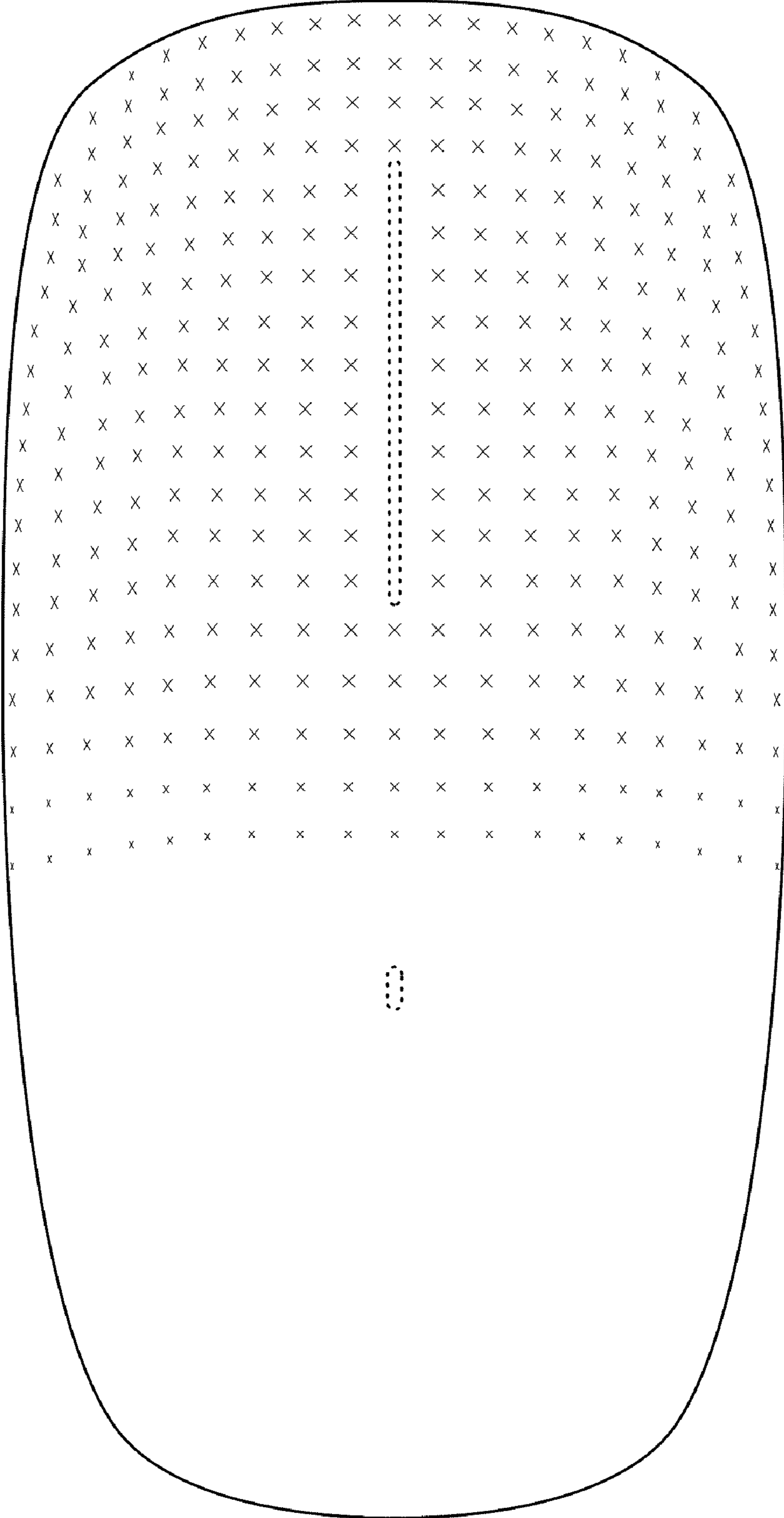

FIG. 2

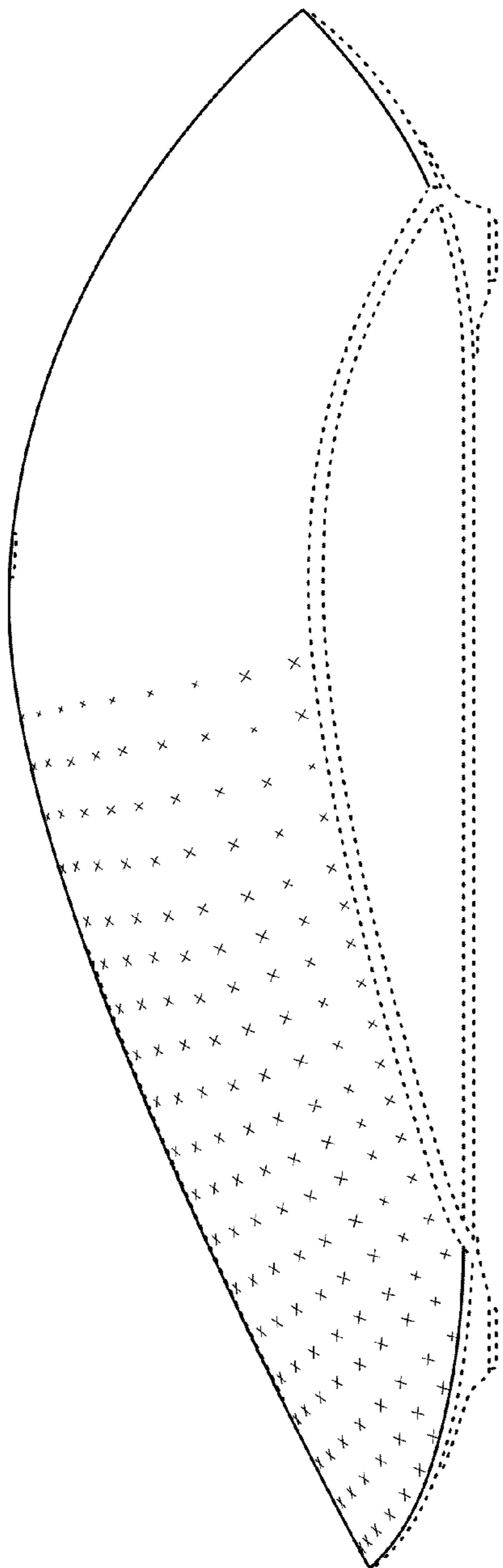

FIG. 3

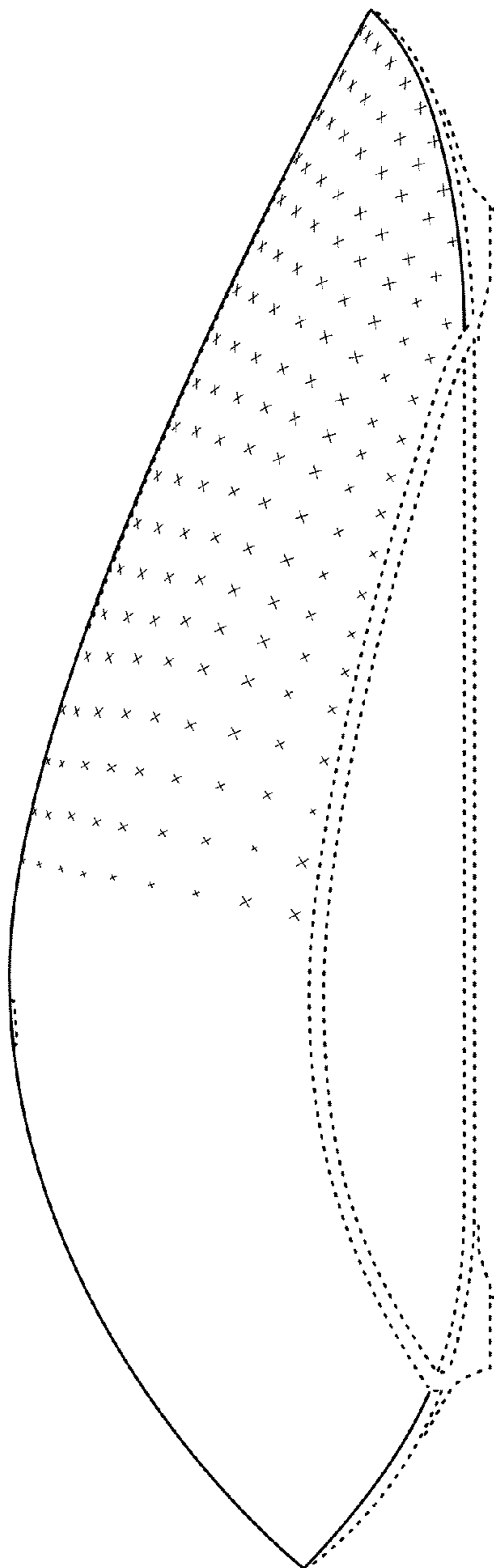

FIG. 4

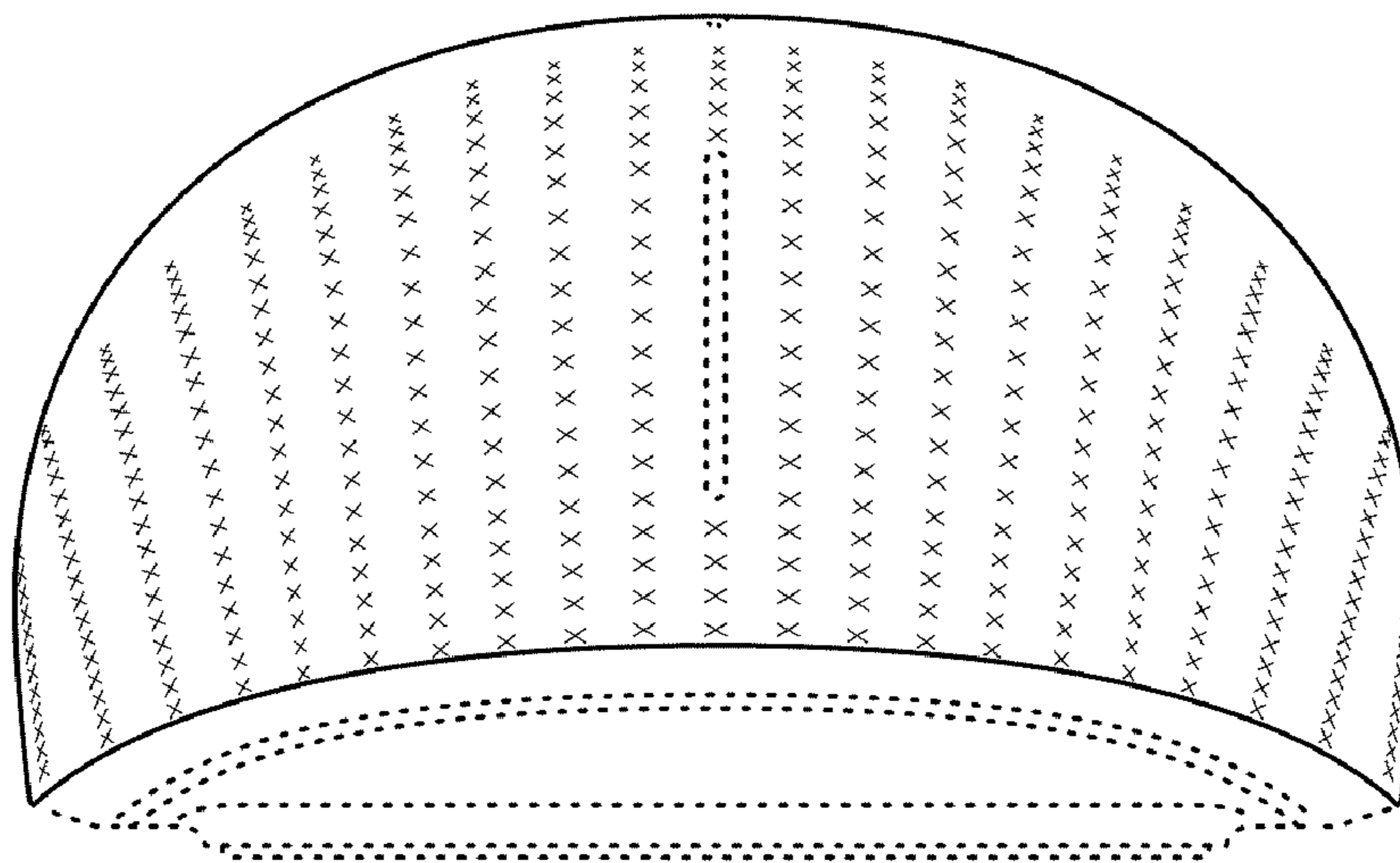

FIG. 5

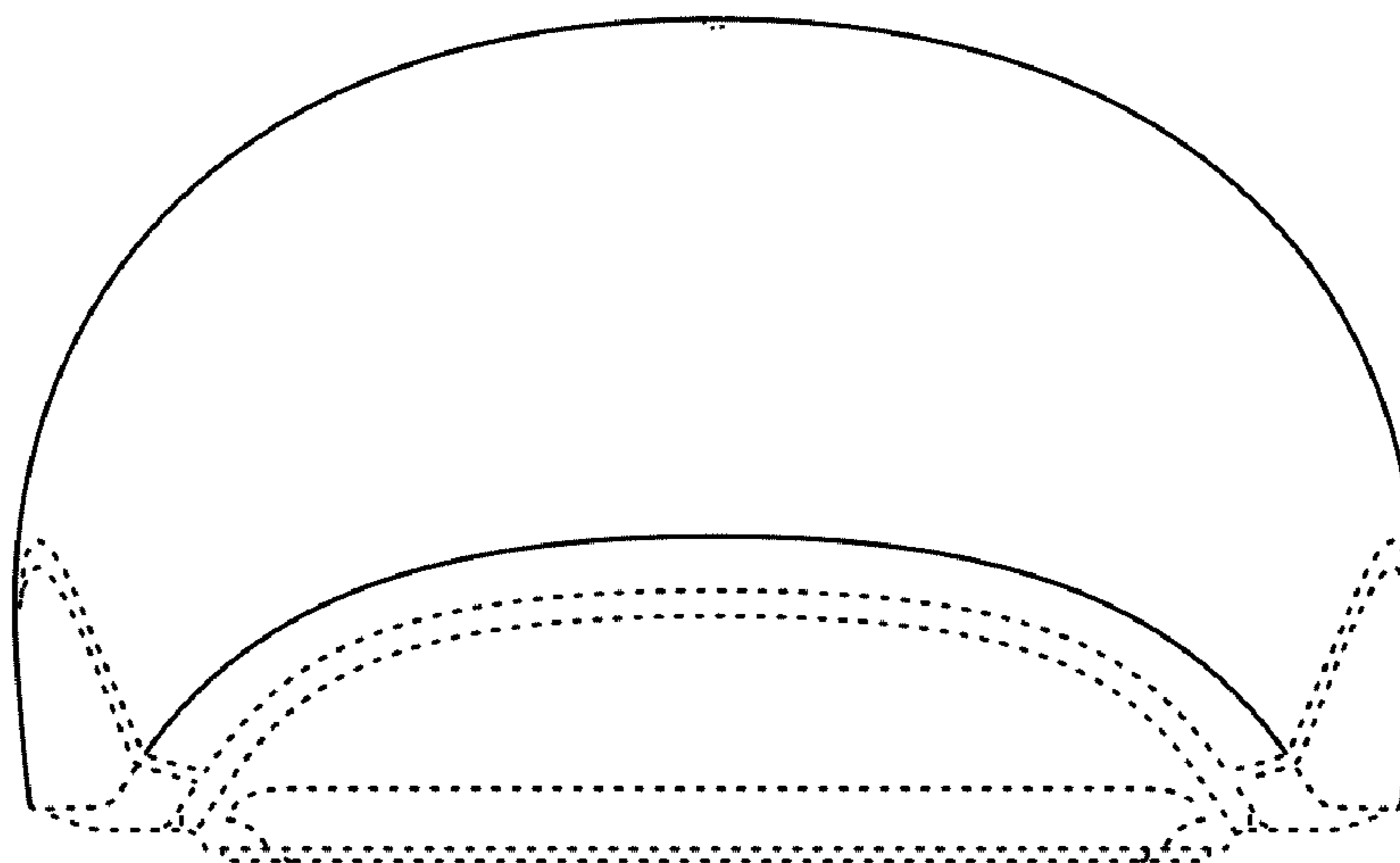

FIG. 6

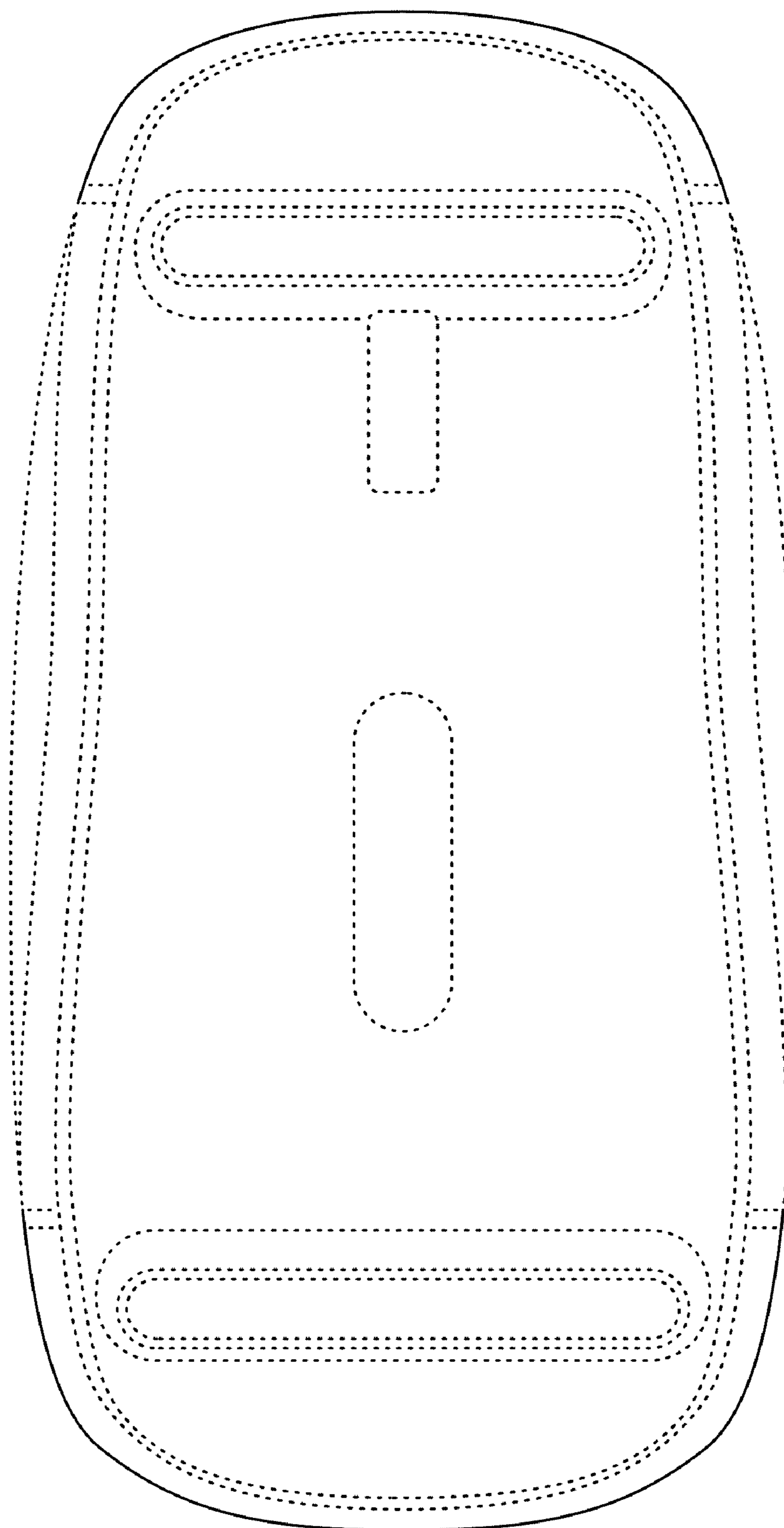

FIG. 7

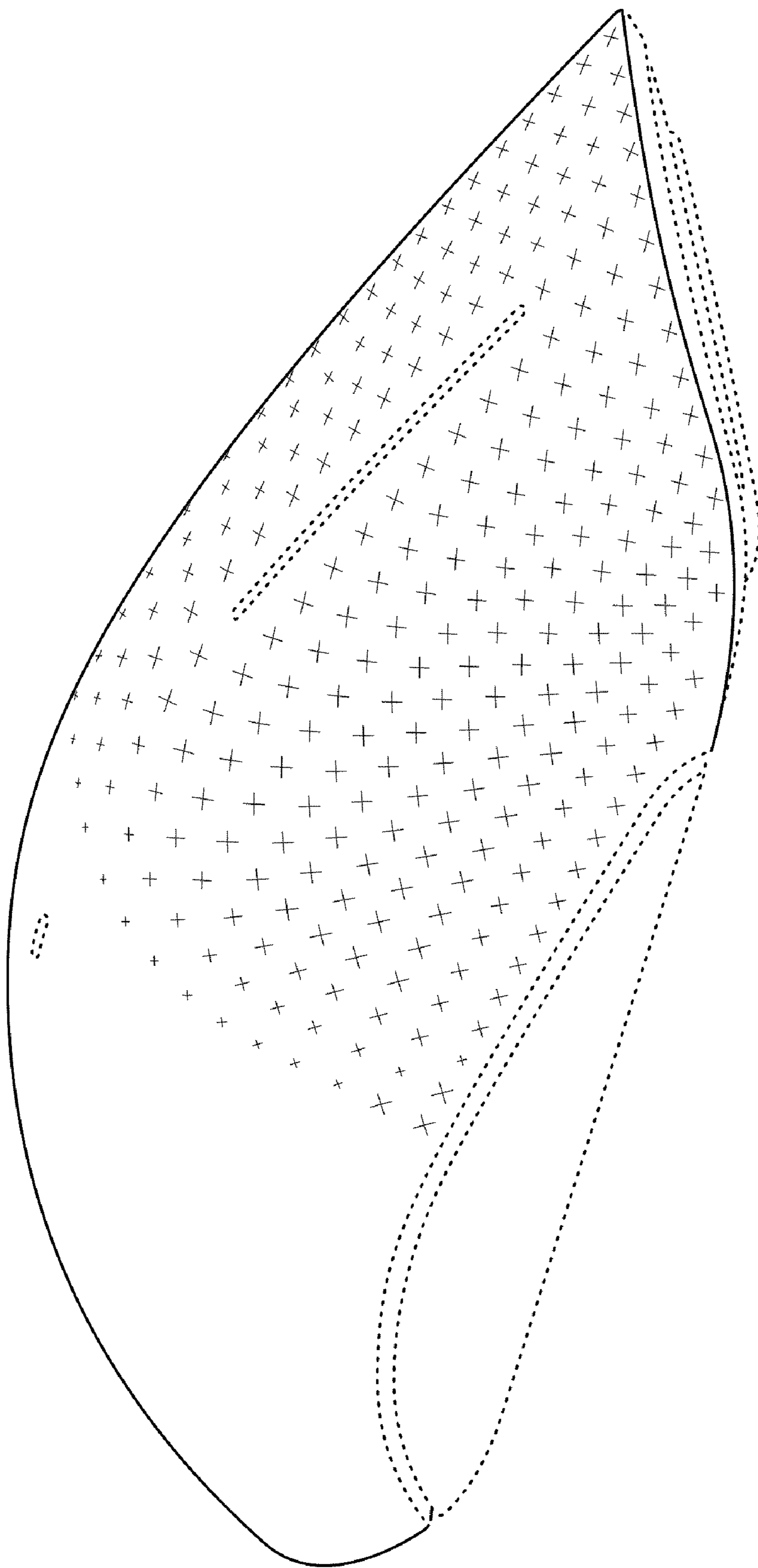

FIG. 8

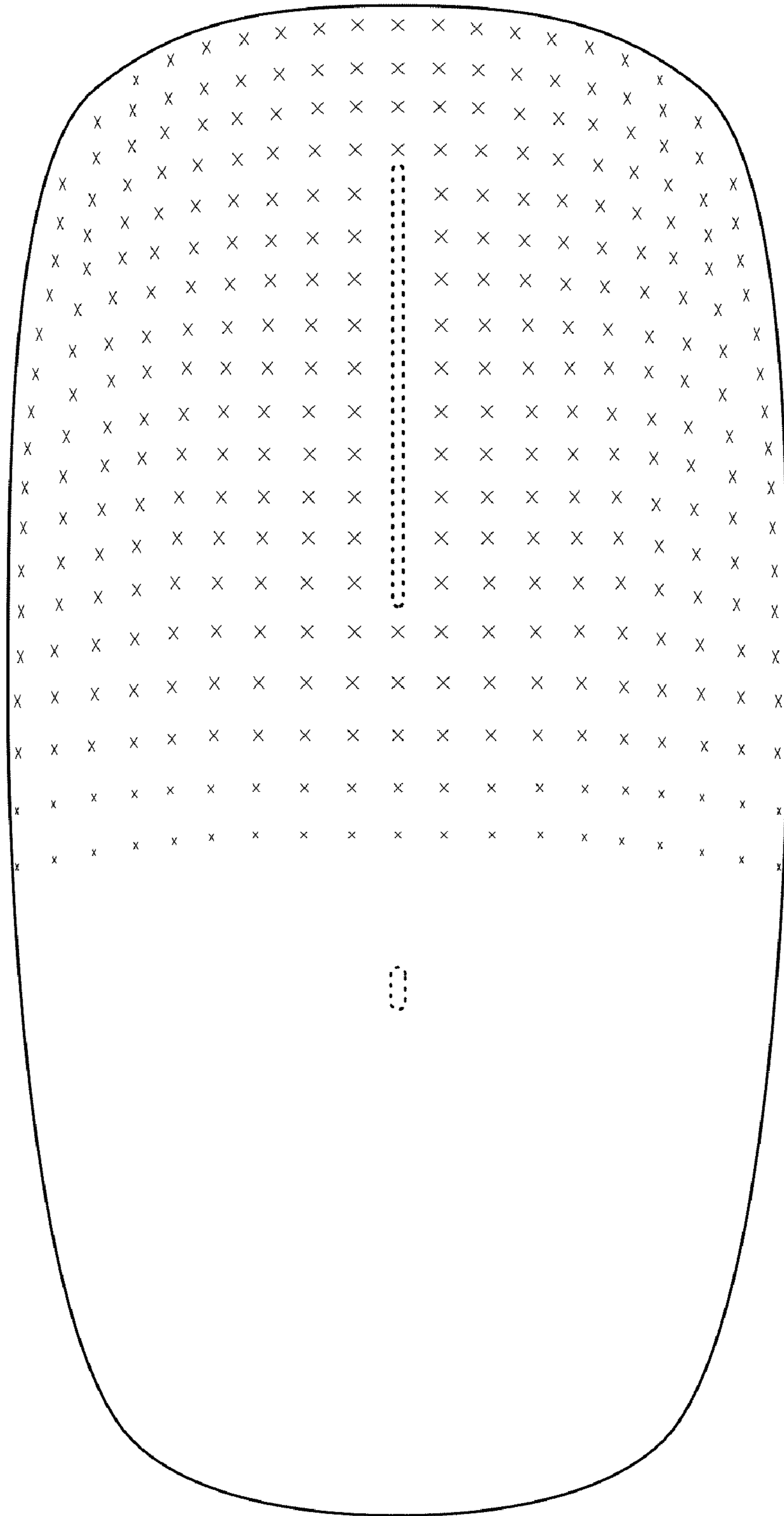

FIG. 9

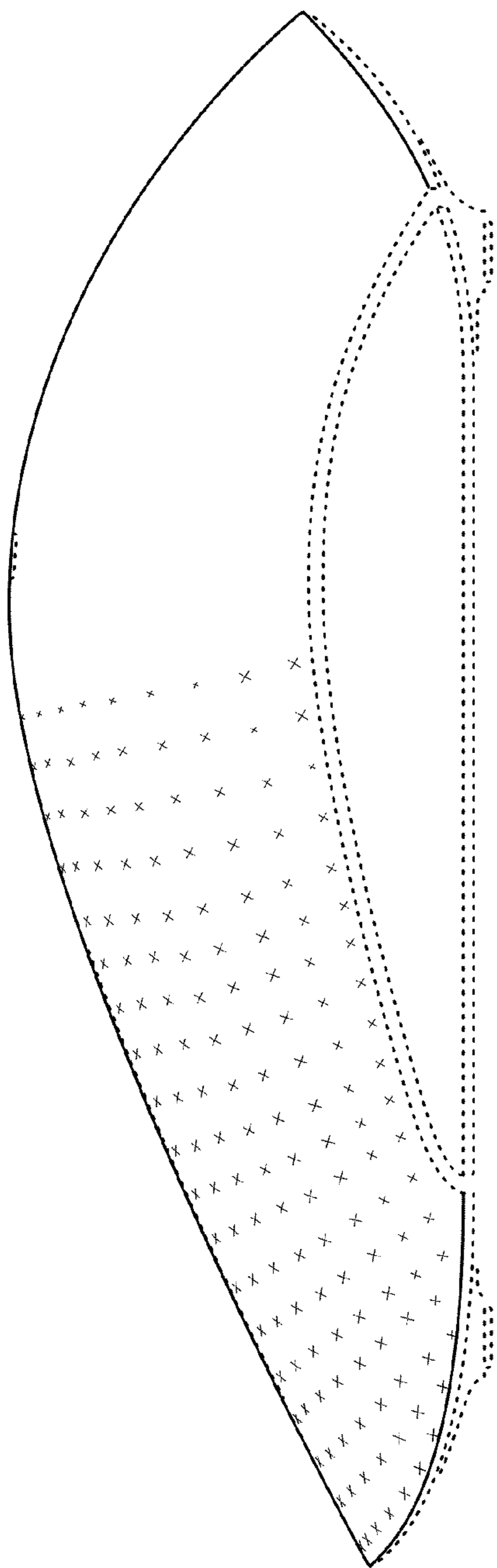

FIG. 10

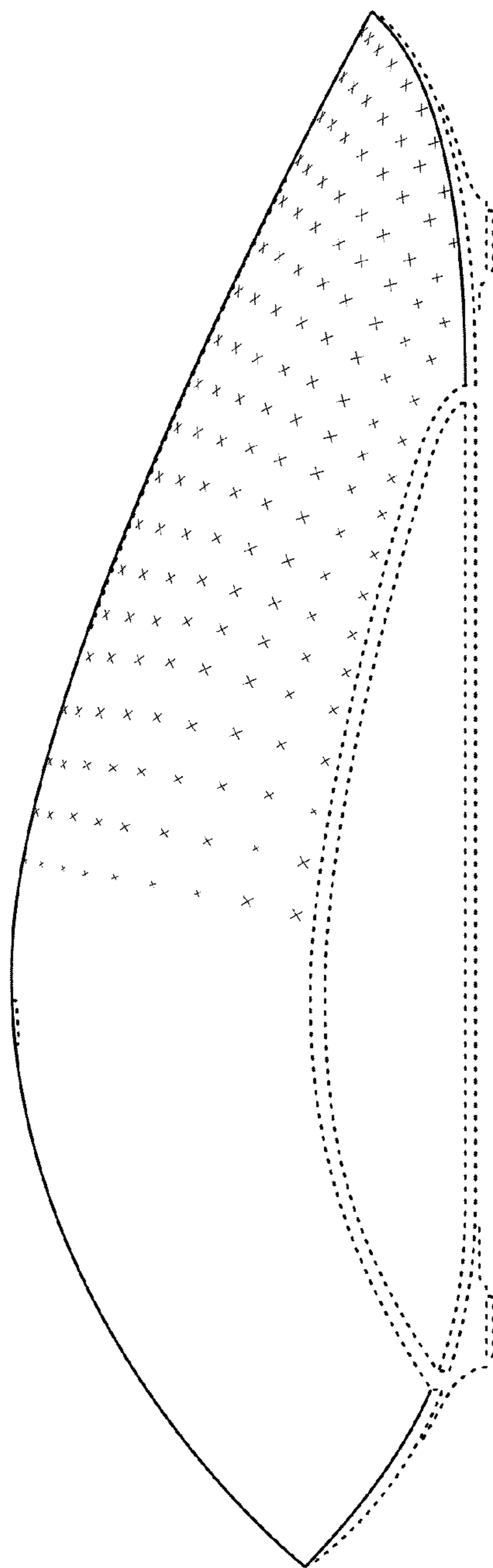

FIG. 11

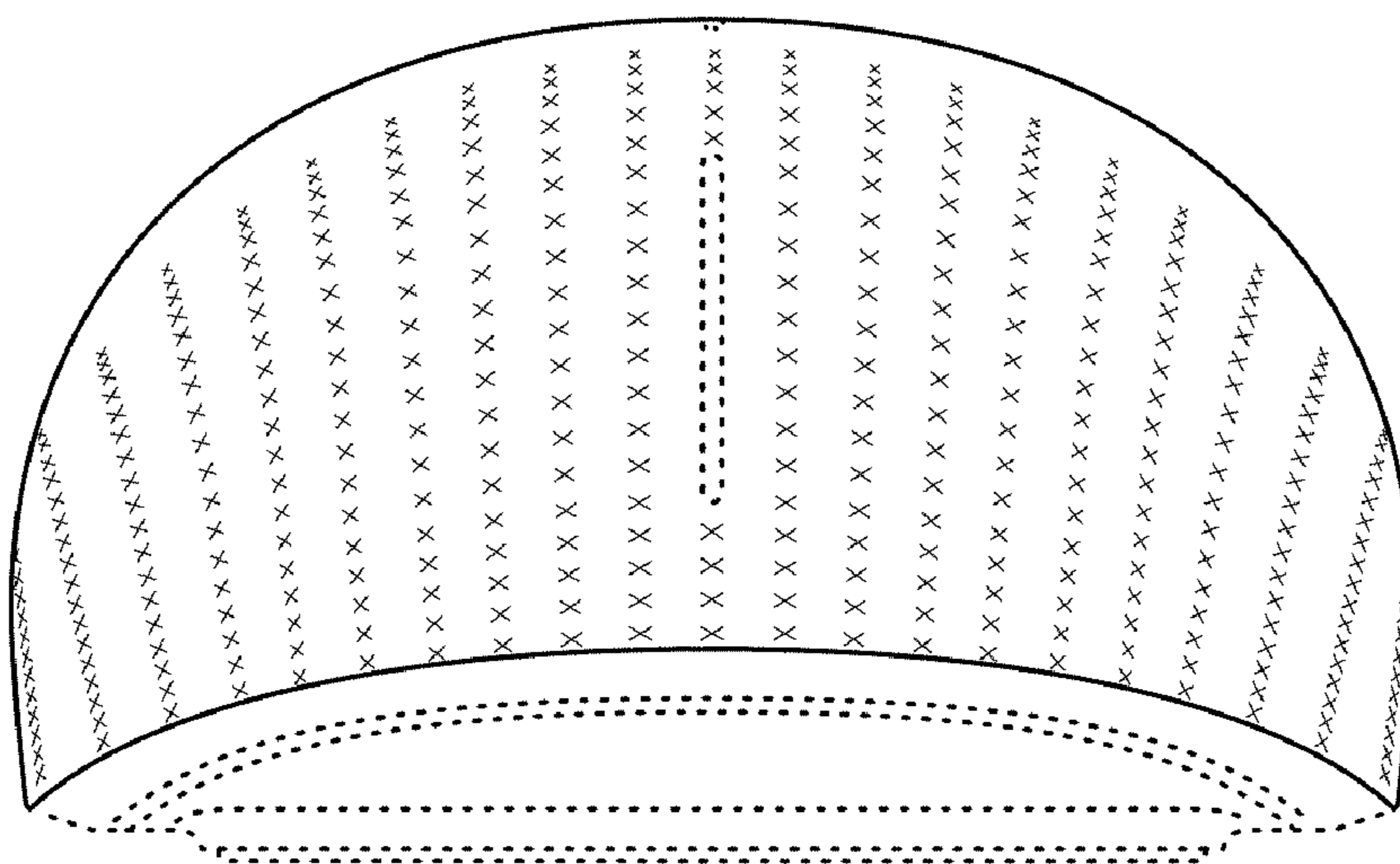

FIG. 12

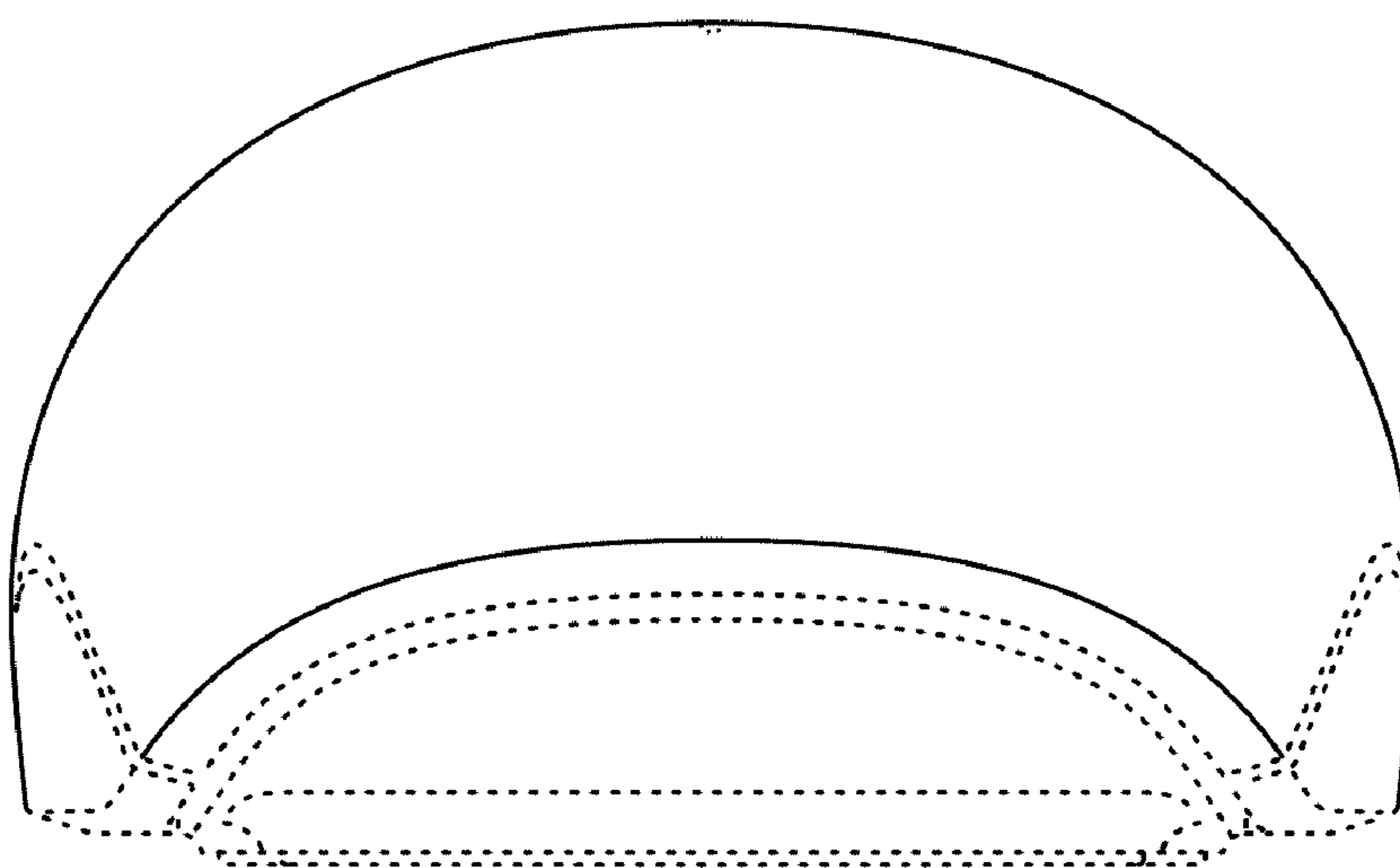

FIG. 13

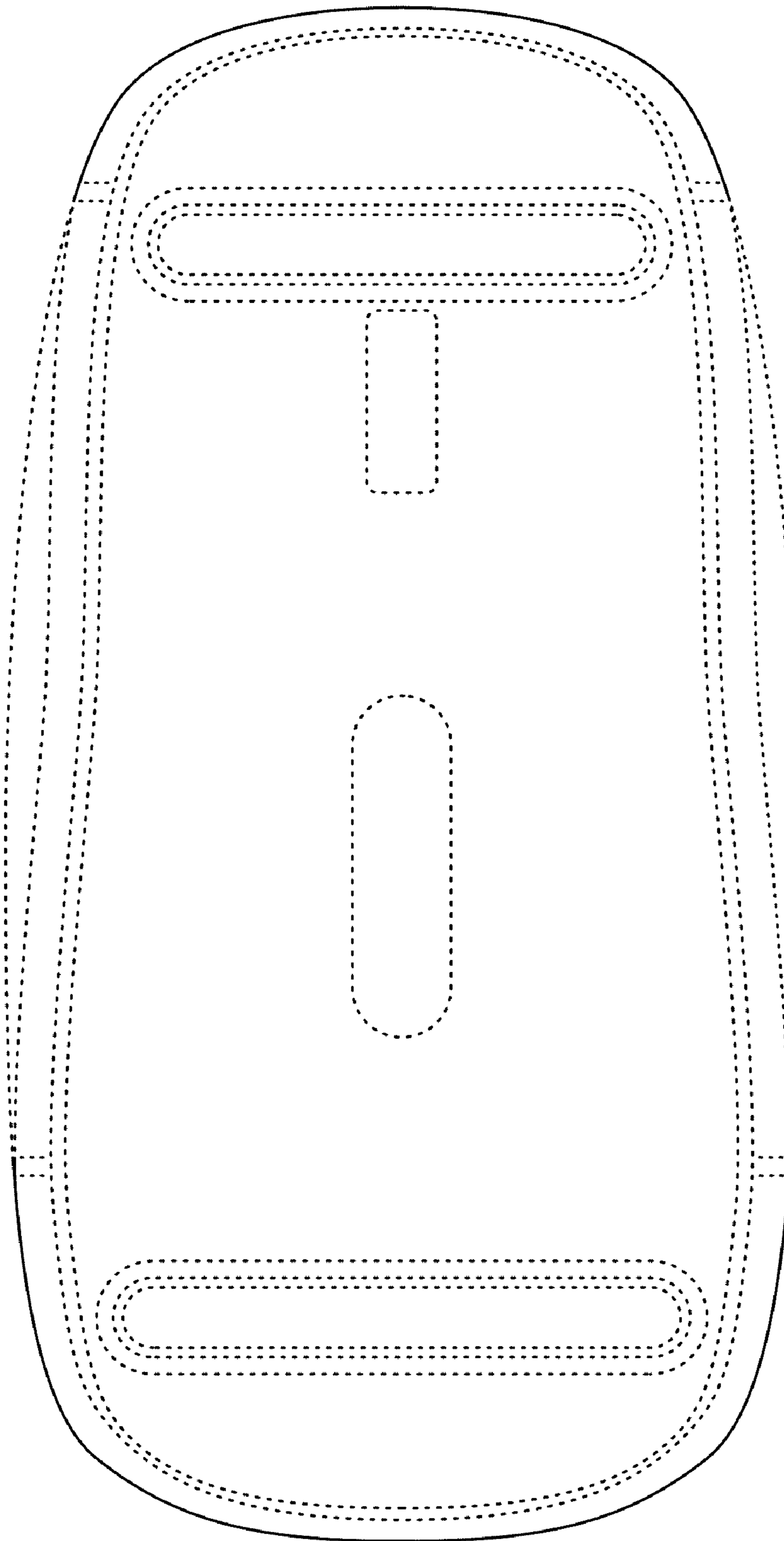

FIG. 14

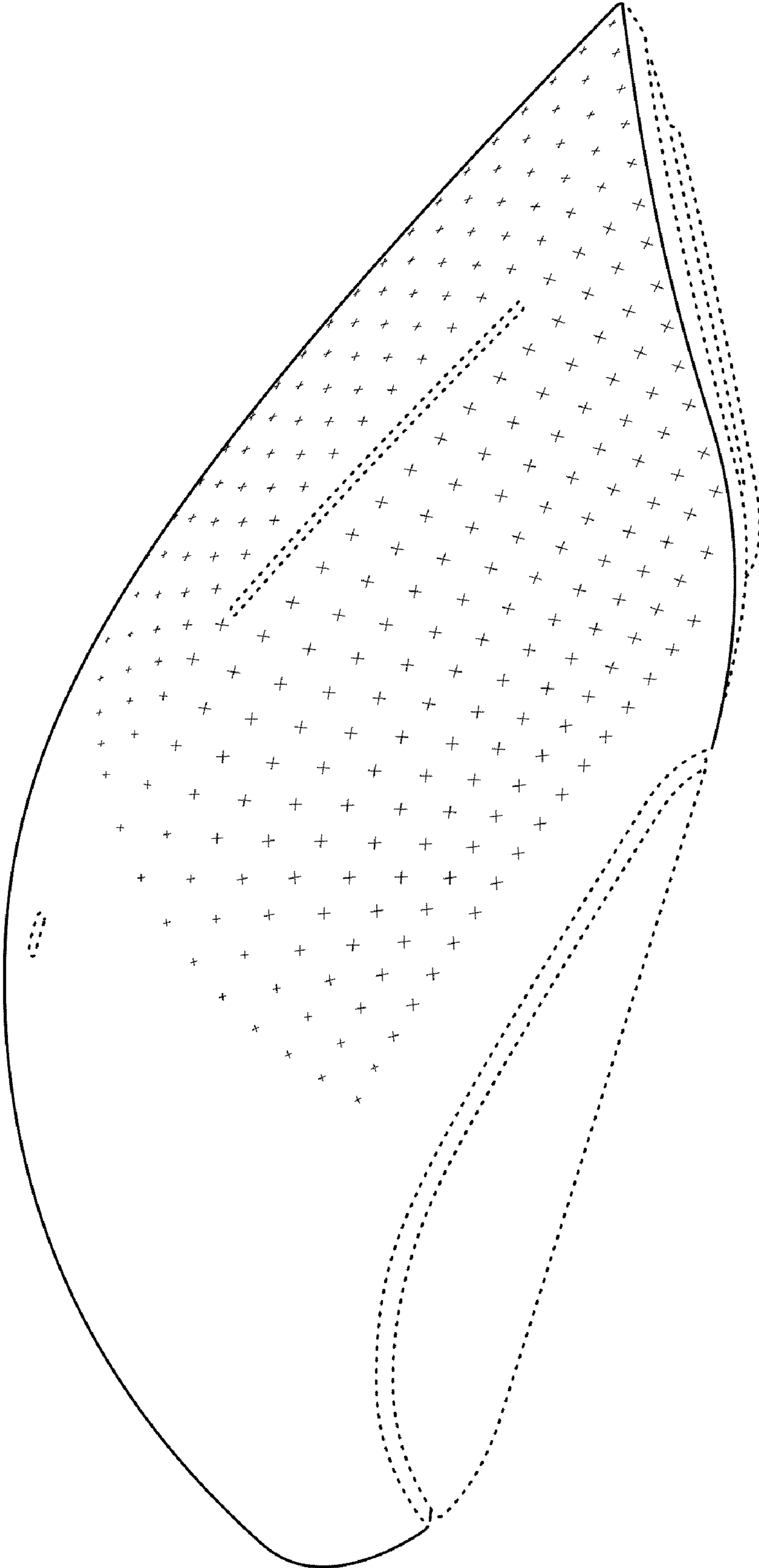

FIG. 15

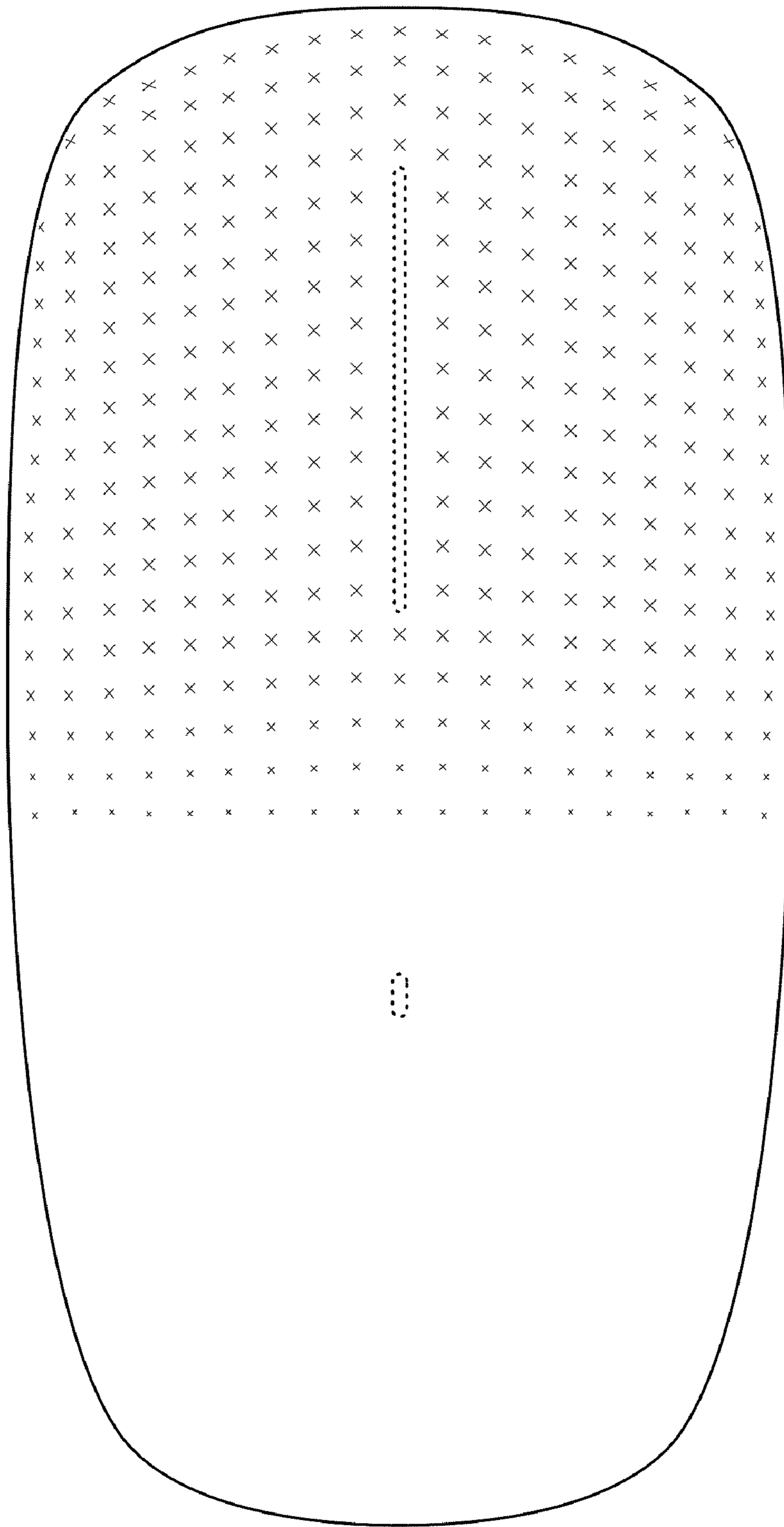

FIG. 16

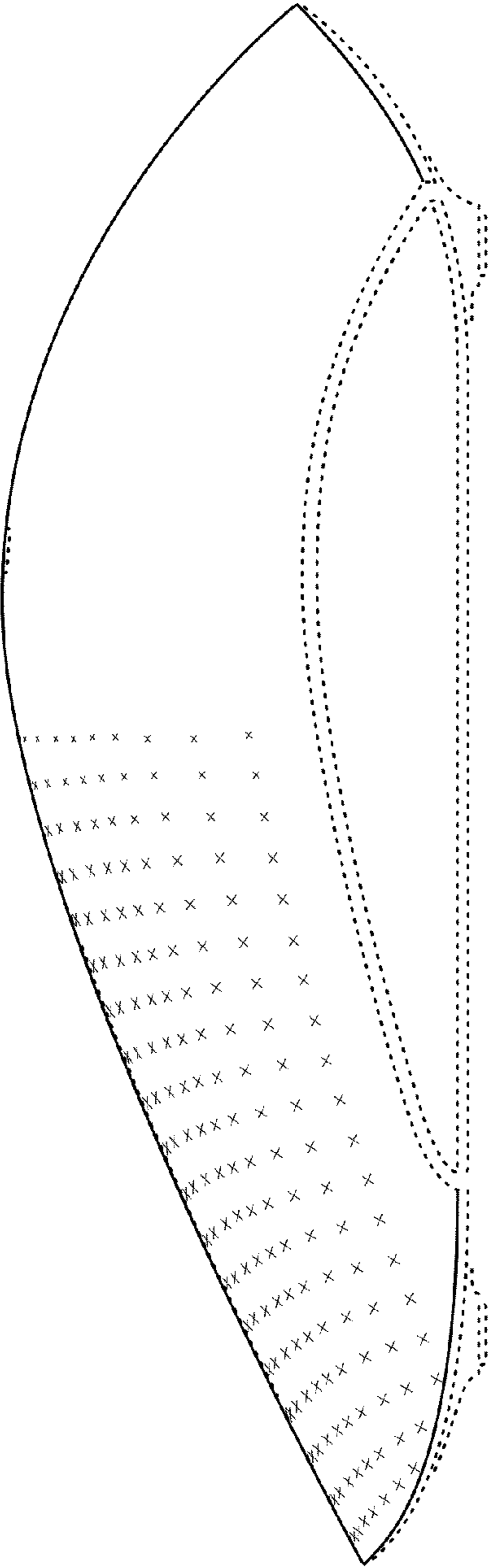

FIG. 17

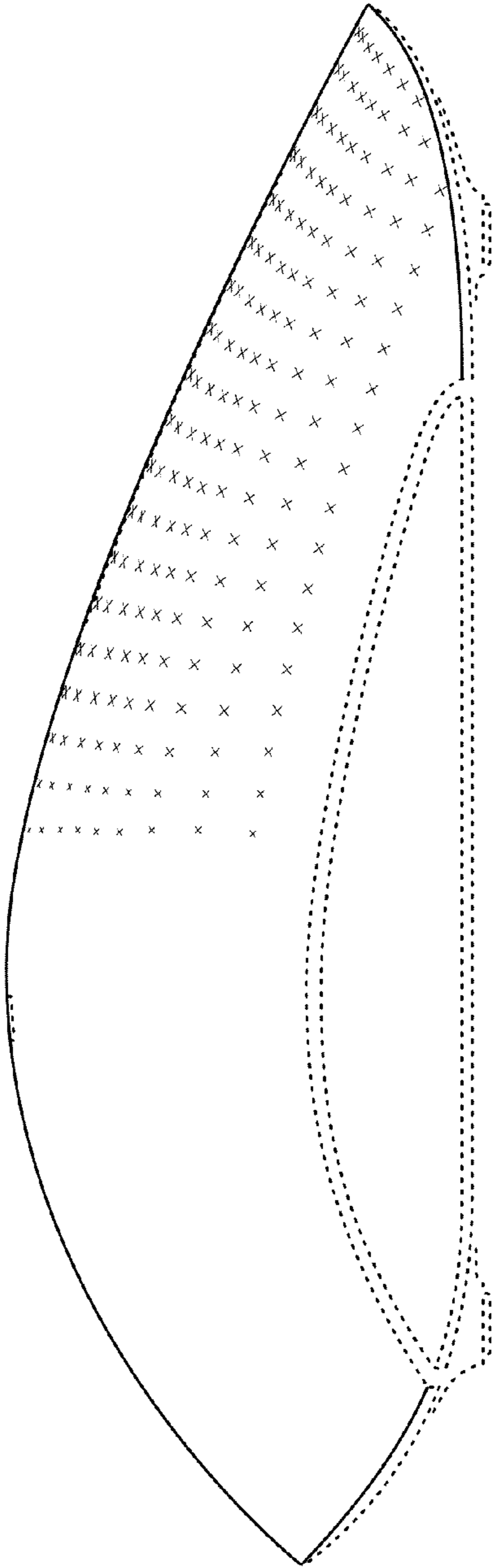

FIG. 18

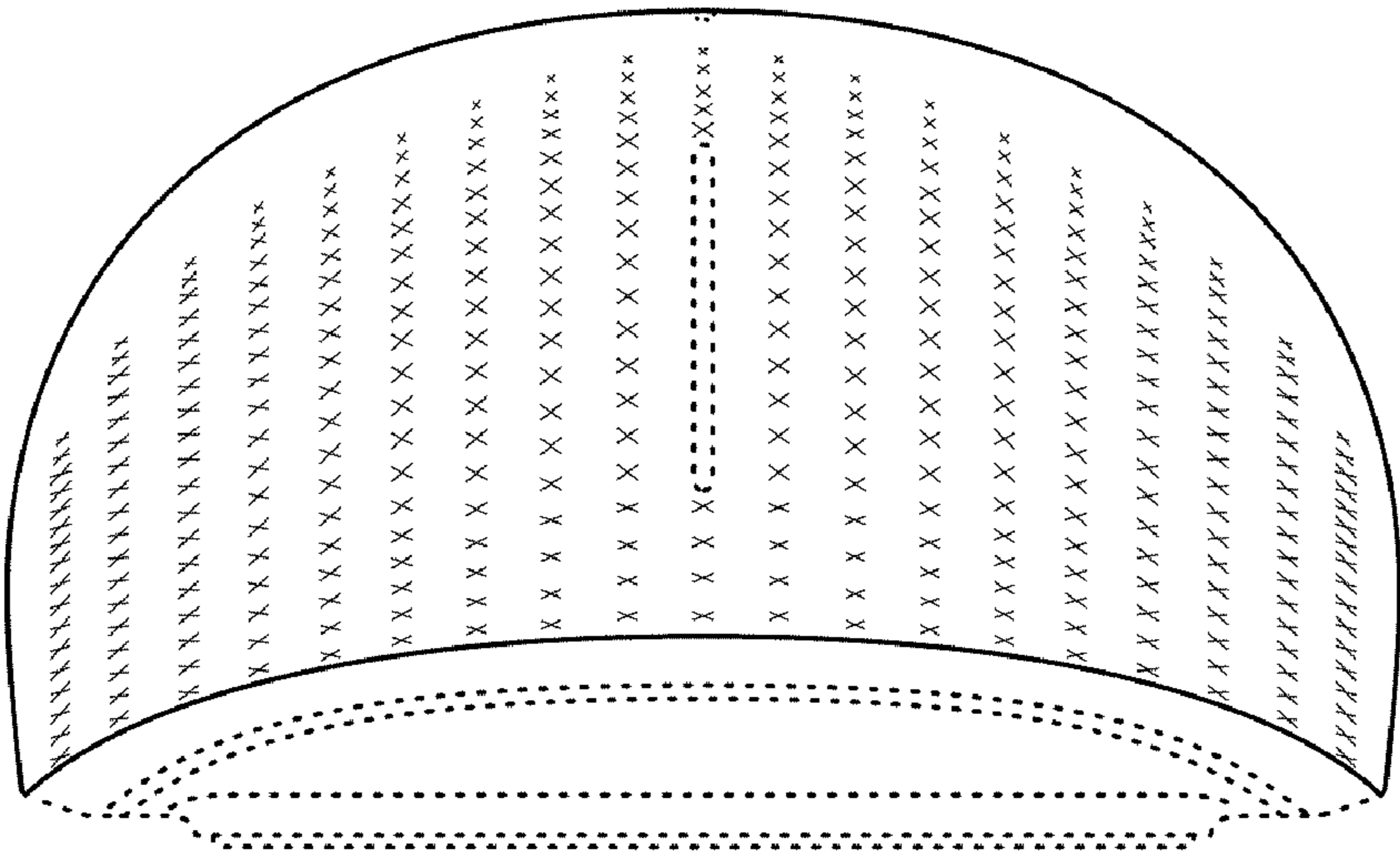

FIG. 19

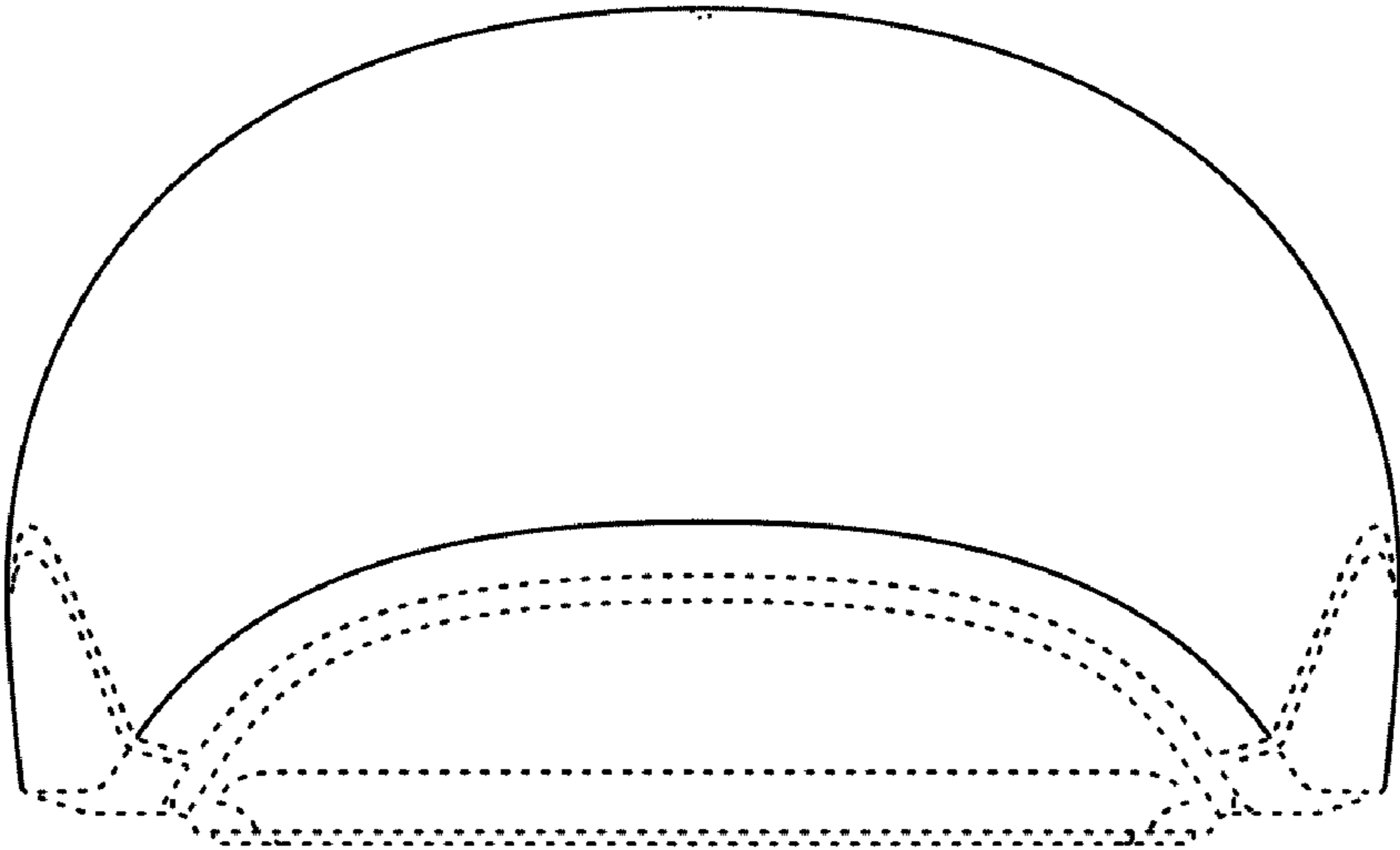

FIG. 20

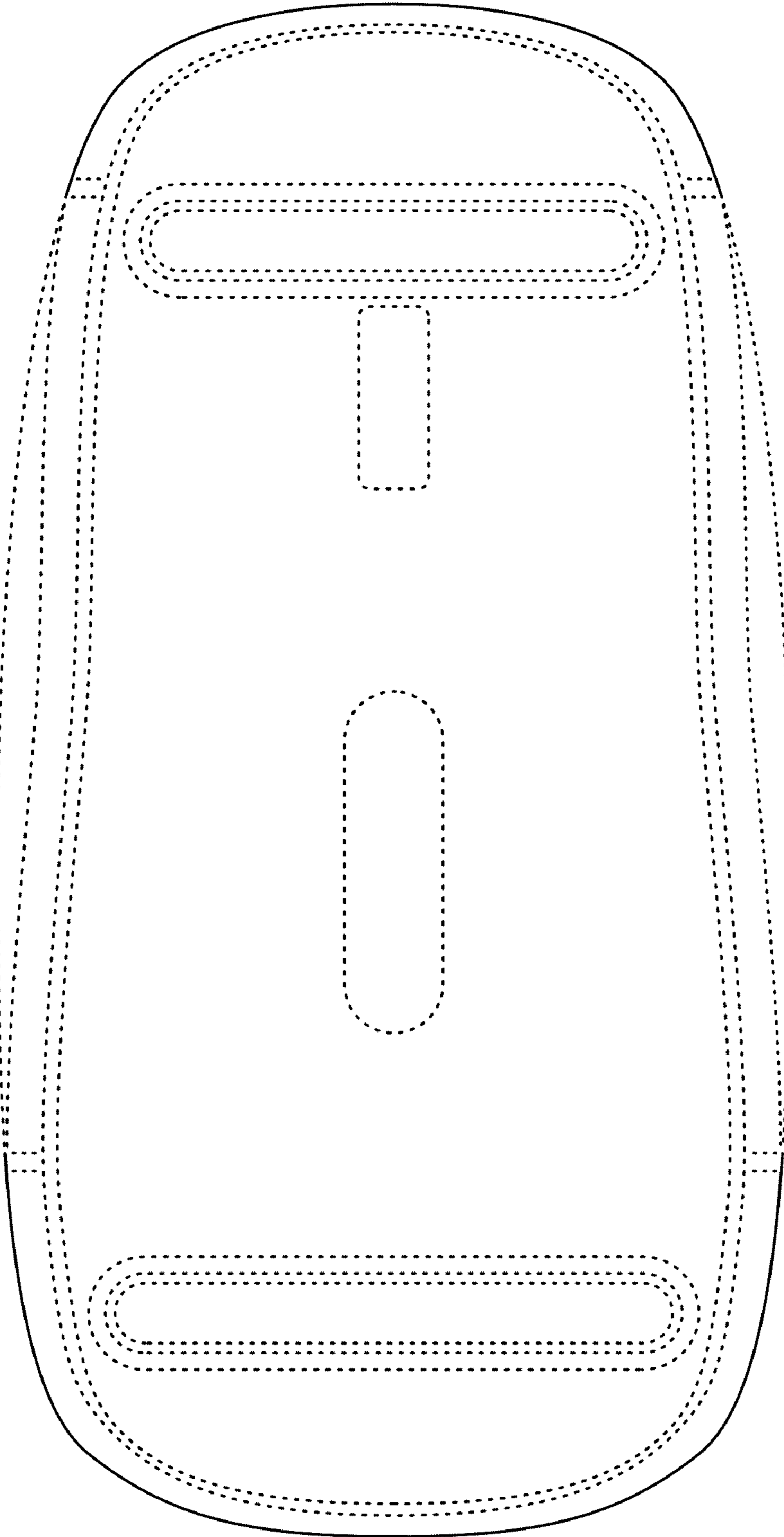

FIG. 21