

US00D642526S

(12) **United States Design Patent**  
**Presz, Jr. et al.**

(10) **Patent No.:** **US D642,526 S**  
(45) **Date of Patent:** **\*\* Aug. 2, 2011**

(54) **WIND TURBINE**

(75) Inventors: **Walter M. Presz, Jr.**, Wilbraham, MA  
(US); **Michael J. Werle**, West Hartford,  
CT (US)

(73) Assignee: **FloDesign Wind Turbine Corp.**,  
Waltham, MA (US)

(\*\*) Term: **14 Years**

(21) Appl. No.: **29/378,833**

(22) Filed: **Nov. 10, 2010**

(51) **LOC (9) Cl.** ..... **13-01**

(52) **U.S. Cl.** ..... **D13/115**

(58) **Field of Classification Search** ..... D13/115,  
D13/118, 122, 199; D12/344, 345; D15/1,  
D15/199; D21/458; 290/52, 54, 55; 415/916;  
416/24, 31, 37, 38, 132 B, 132 R, 141, 142,  
416/176, 177, 196 A

See application file for complete search history.

(56) **References Cited**

**U.S. PATENT DOCUMENTS**

D252,877 S \* 9/1979 Hanson ..... D15/1  
4,297,076 A \* 10/1981 Donham et al. .... 416/37  
D267,951 S \* 2/1983 Smith ..... D15/1  
4,398,096 A \* 8/1983 Faurholtz ..... 290/55

D305,419 S \* 1/1990 Korneski ..... D13/115  
6,168,373 B1 \* 1/2001 Vauthier ..... 415/7  
D487,060 S \* 2/2004 Ehrenberger ..... D13/115  
D517,986 S \* 3/2006 Wobben ..... D13/115  
D543,495 S \* 5/2007 Williams ..... D12/345

\* cited by examiner

*Primary Examiner* — Stella Reid

*Assistant Examiner* — Derrick Holland

(74) *Attorney, Agent, or Firm* — Richard M. Klein; Fay  
Sharpe LLP

(57) **CLAIM**

The ornamental design for a wind turbine, as shown and  
described.

**DESCRIPTION**

FIG. 1 is a front view of the wind turbine;  
FIG. 2 is a left side view of the wind turbine;  
FIG. 3 is a rear view of the wind turbine;  
FIG. 4 is a right side view the wind turbine;  
FIG. 5 is a top view of the wind turbine;  
FIG. 6 is a bottom view of the wind turbine;  
FIG. 7 is a top front left perspective view of the wind turbine;  
and,  
FIG. 8 is a top rear left perspective view of the wind turbine.  
The broken lines shown represent unclaimed subject matter  
and form no part of the claimed design.

**1 Claim, 4 Drawing Sheets**

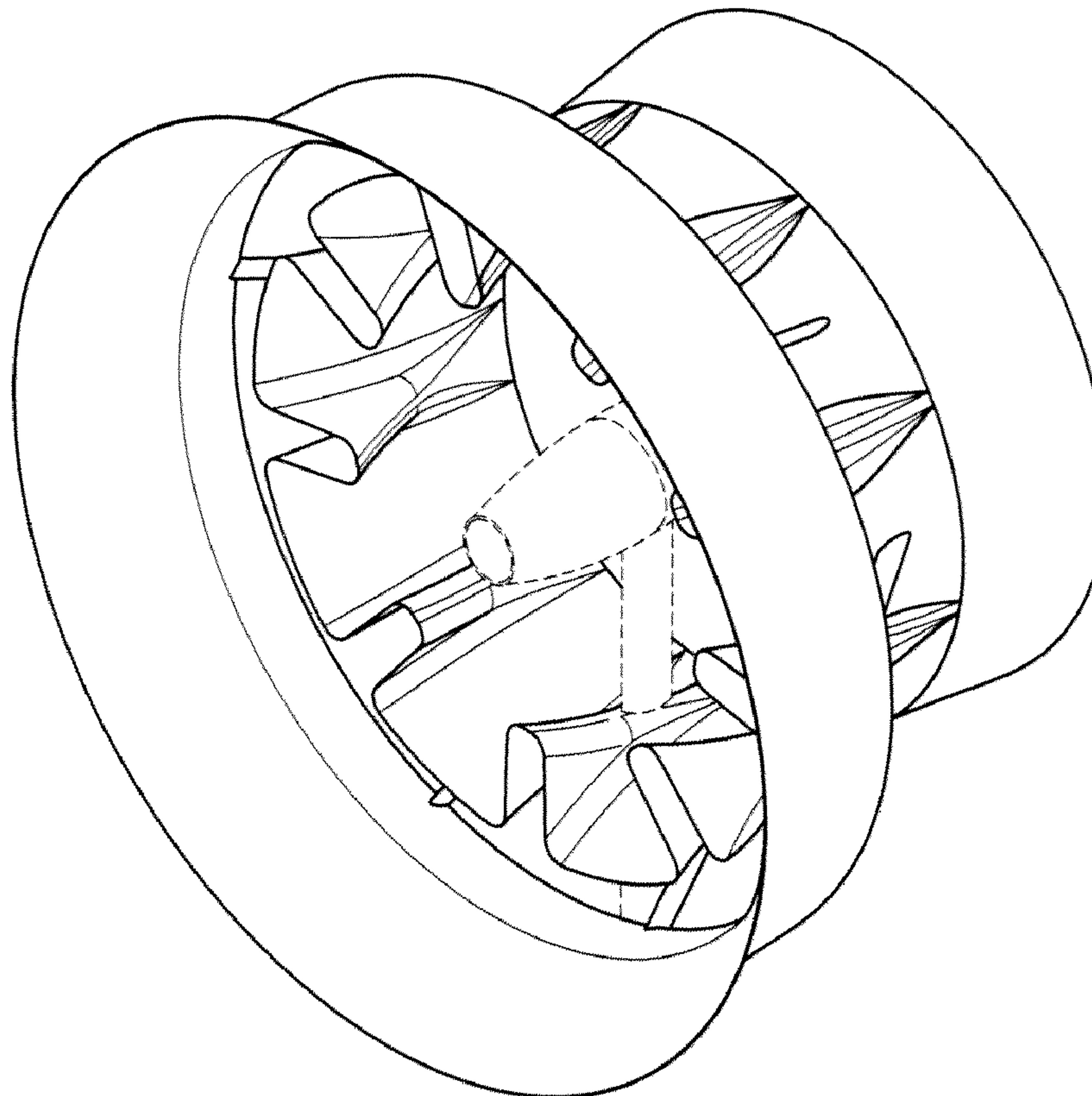

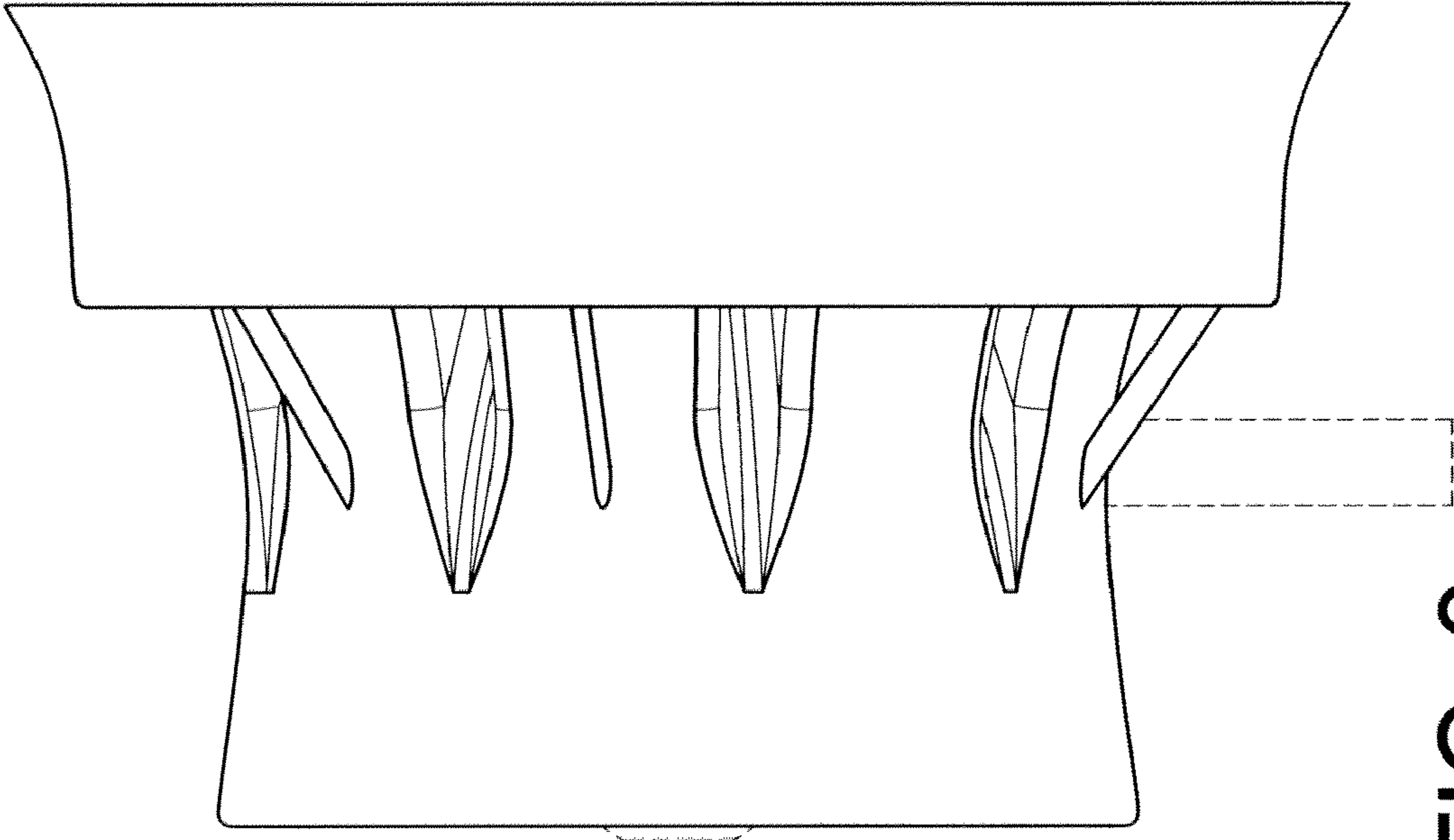

FIG. 2

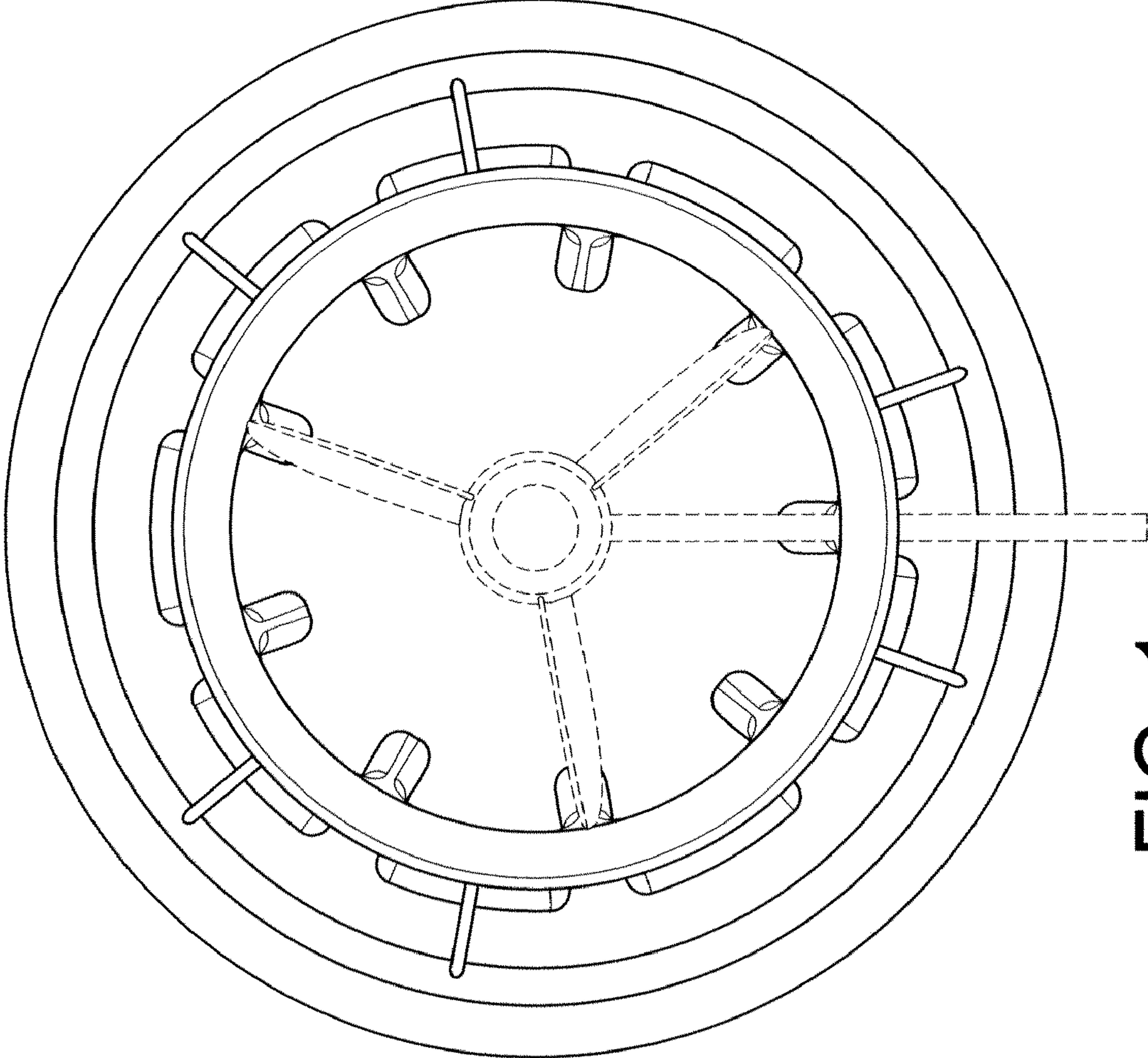

FIG. 1

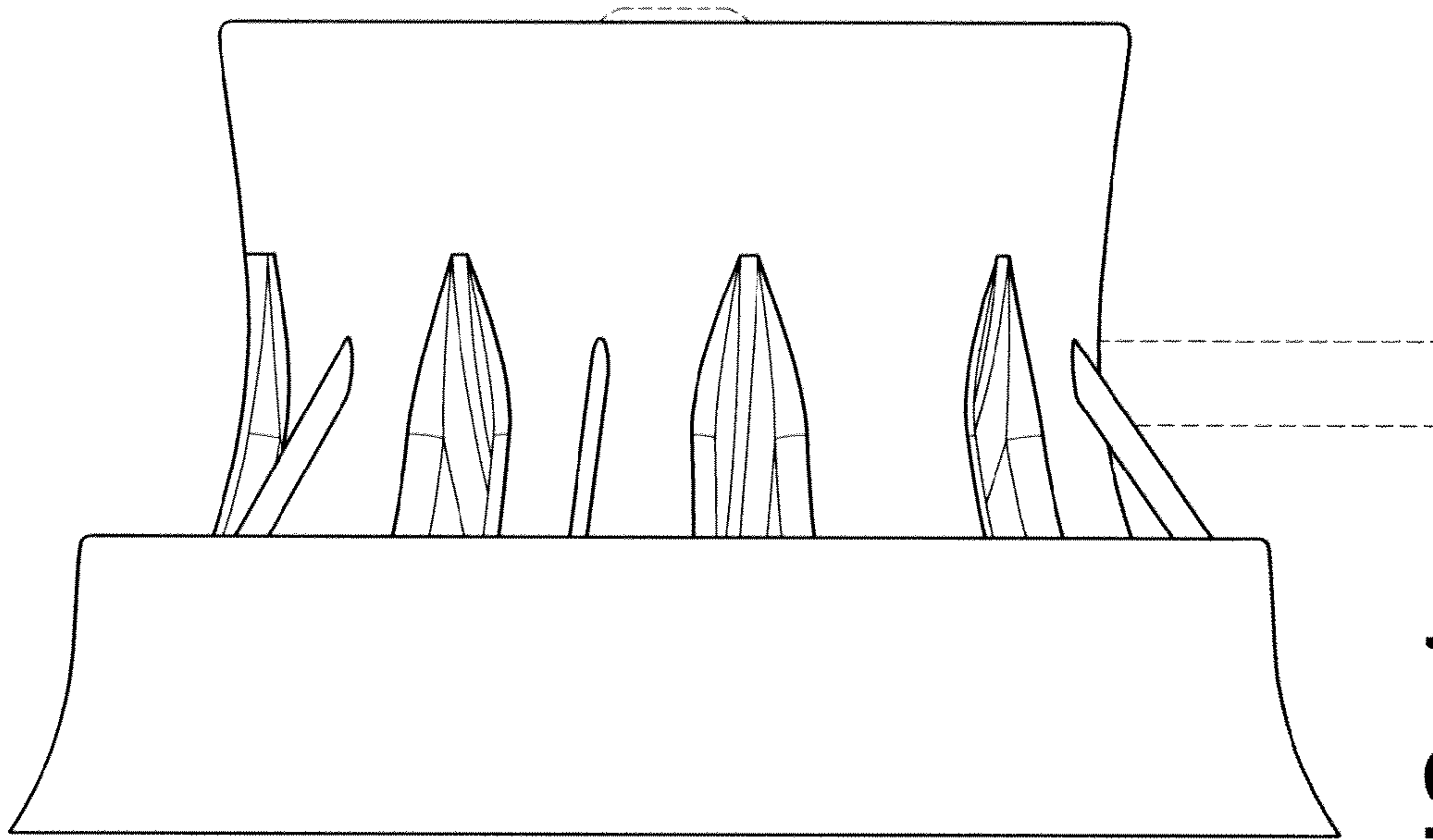

FIG. 4

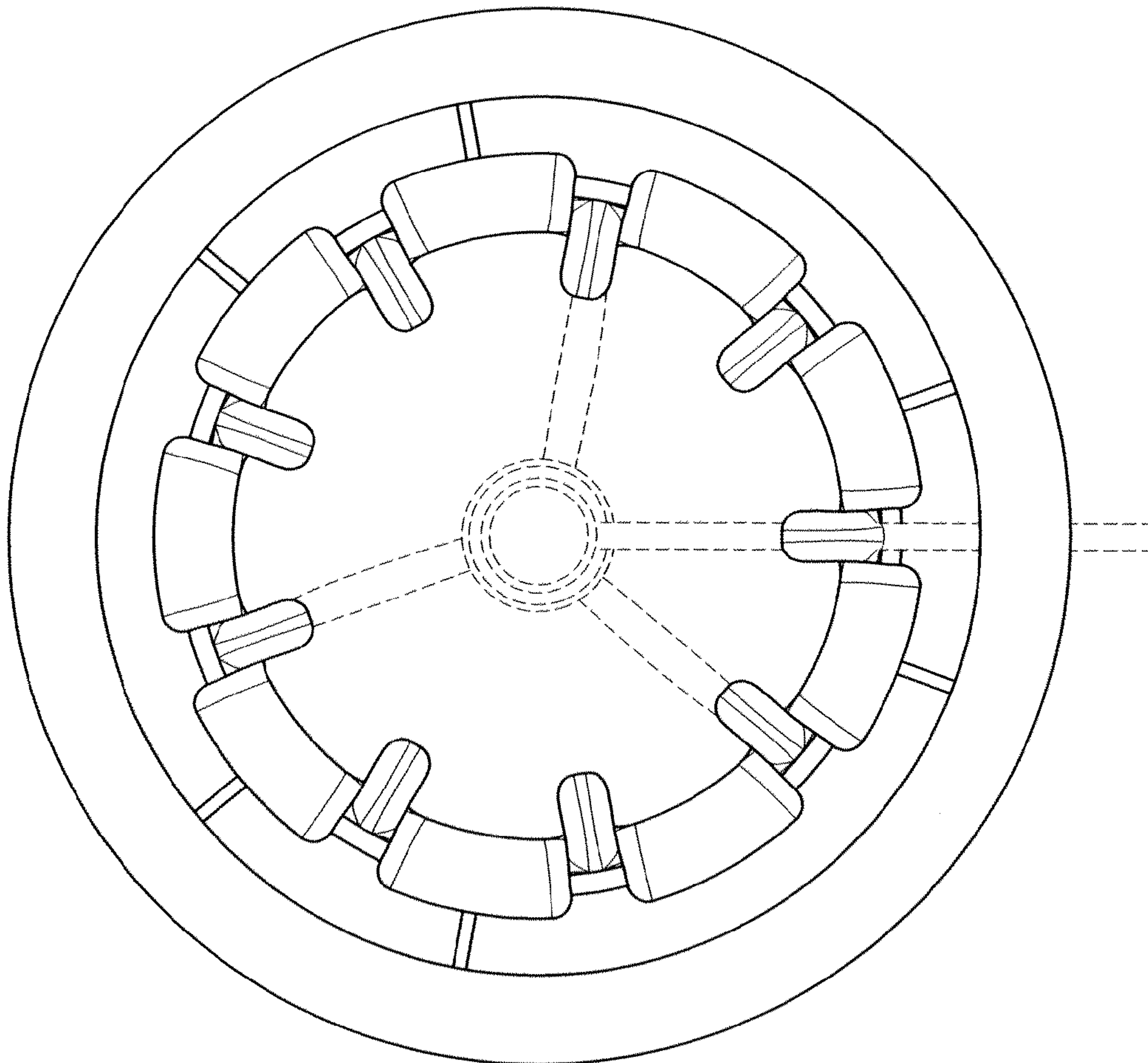

FIG. 3



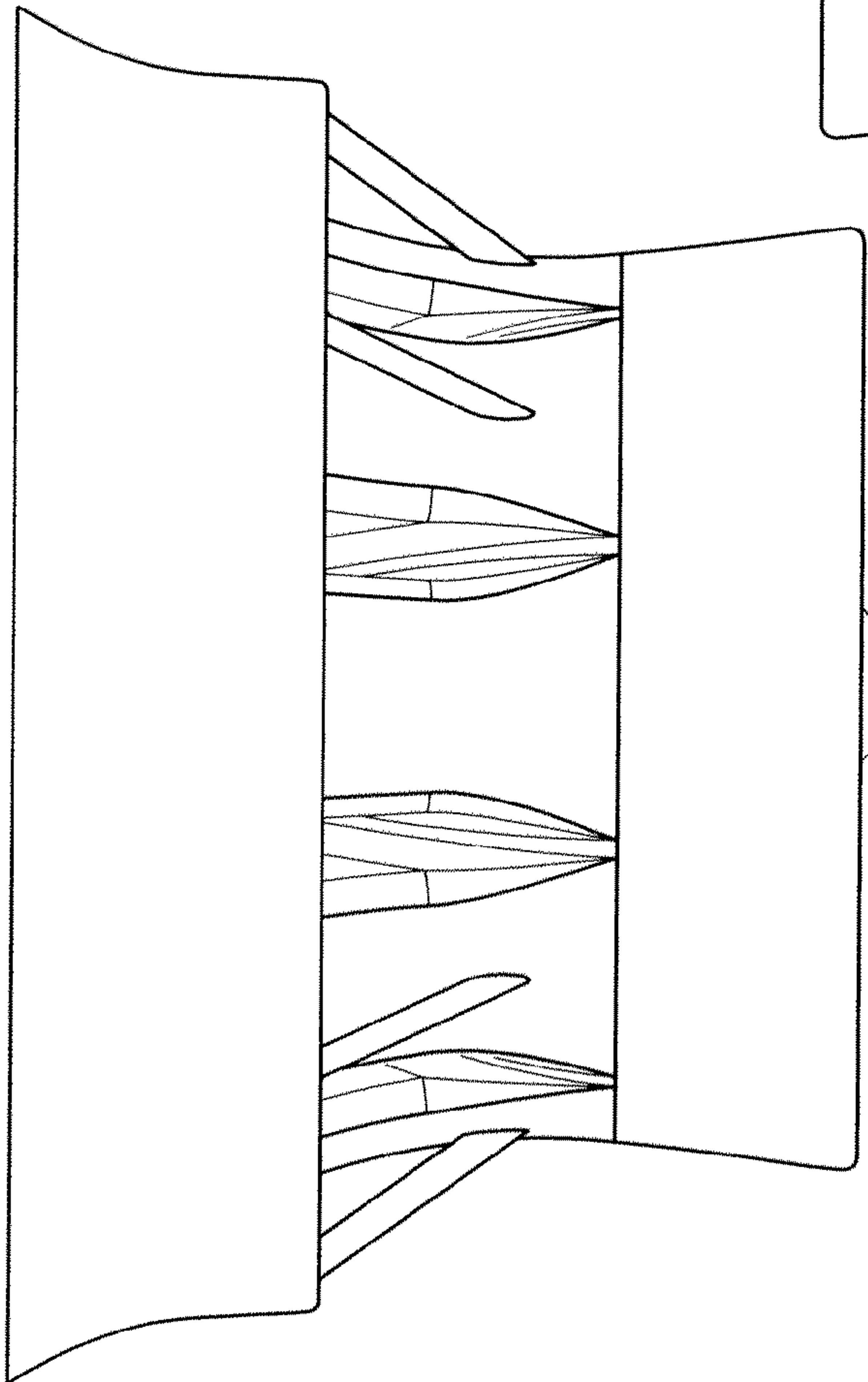

FIG. 5

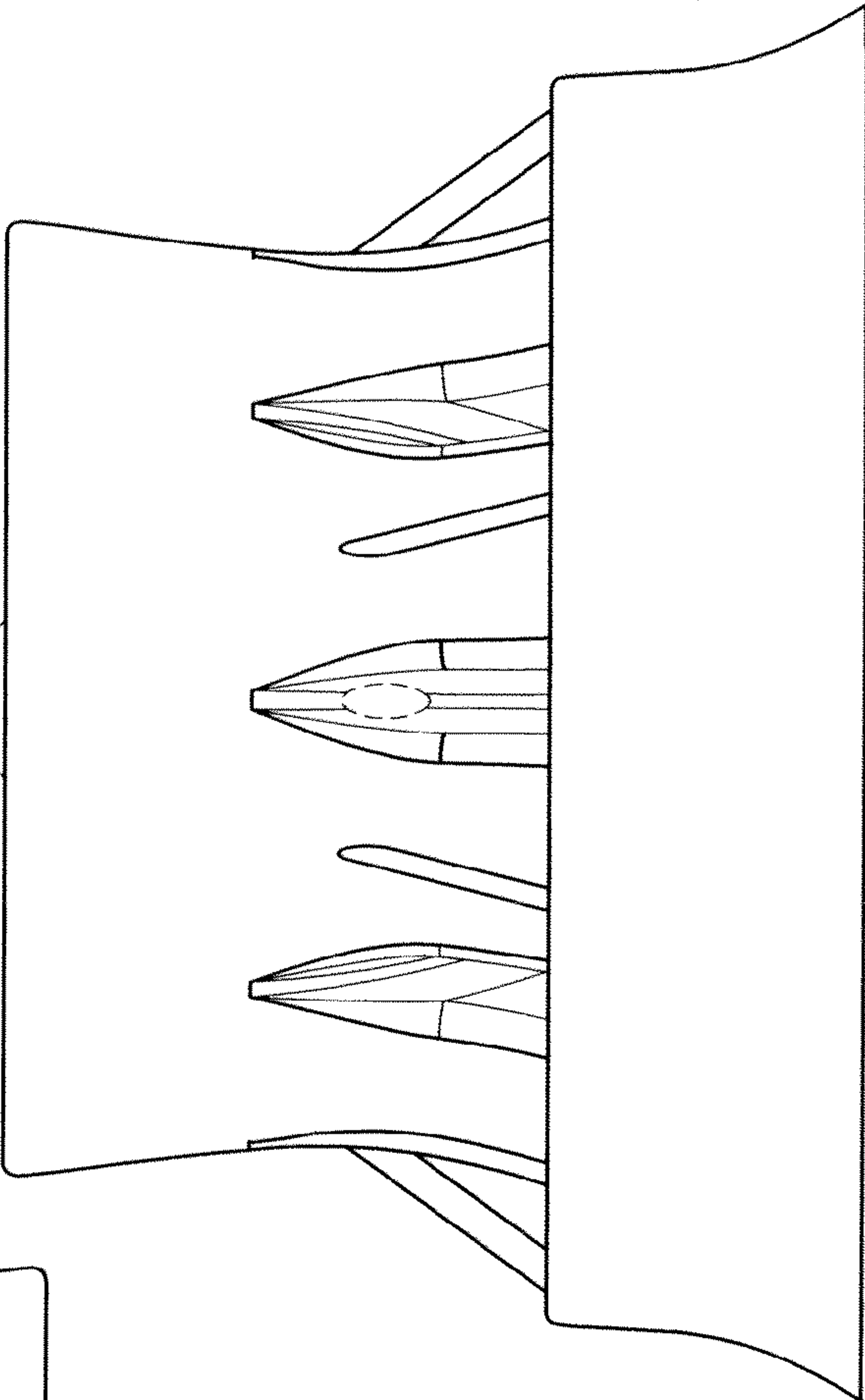

FIG. 6

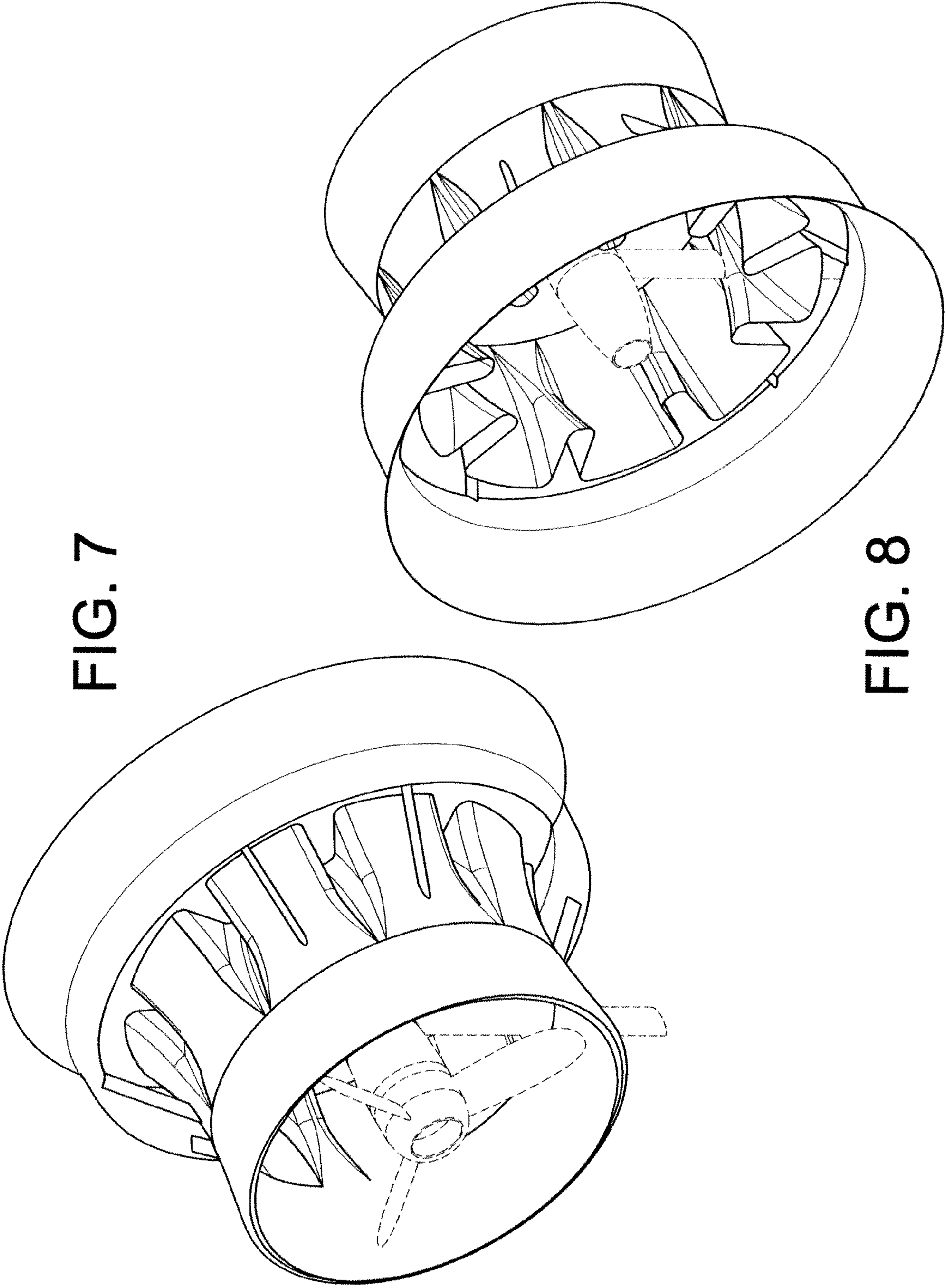

FIG. 7

FIG. 8