



US00D642522S

(12) **United States Design Patent**
Budike, Jr.

(10) **Patent No.:** **US D642,522 S**

(45) **Date of Patent:** **** Aug. 2, 2011**

(54) **WAVE CHARGER**

(75) Inventor: **Lothar Budike, Jr.**, Villanova, PA (US)

(73) Assignee: **Hot Doc, Inc.**, Villanova, PA (US)

(**) Term: **14 Years**

(21) Appl. No.: **29/379,270**

(22) Filed: **Nov. 17, 2010**

(51) **LOC (9) Cl.** **13-02**

(52) **U.S. Cl.** **D13/108**

(58) **Field of Classification Search** D13/107–110,
D13/118–119, 184, 199; D14/251, 253,
D14/432, 434; 320/107–115

See application file for complete search history.

(56) **References Cited**

U.S. PATENT DOCUMENTS

2,772,382	A	*	11/1956	Escoffery	257/658
D461,814	S	*	8/2002	Felix et al.	D14/434
D474,735	S	*	5/2003	Lee	D13/108
D483,327	S	*	12/2003	Matsuoka	D13/108
D502,913	S	*	3/2005	Fukami et al.	D13/108
D510,066	S	*	9/2005	Hickey et al.	D13/108
D520,014	S	*	5/2006	Harris et al.	D14/434
D530,667	S	*	10/2006	Viduya et al.	D13/107
D532,366	S	*	11/2006	Koizumi	D13/108
D538,740	S	*	3/2007	Dunbar	D13/108
D558,207	S	*	12/2007	Ikeda et al.	D14/434
D579,408	S	*	10/2008	Benyameen	D13/107
D582,342	S	*	12/2008	Chen et al.	D13/118
D585,021	S	*	1/2009	Surette	D13/119
D609,636	S	*	2/2010	Jensen	D13/108
D620,882	S	*	8/2010	Houghton	D13/108

D623,132	S	*	9/2010	Yano	D13/108
D633,039	S	*	2/2011	Nomi et al.	D13/108
2007/0267998	A1	*	11/2007	Cohen et al.	320/109

* cited by examiner

Primary Examiner — Rosemary K Tarcza

(74) *Attorney, Agent, or Firm* — Volpe and Koenig, P.C.

(57) **CLAIM**

The ornamental design for a wave charger, as shown and described.

DESCRIPTION

FIG. 1 is a top, front, right perspective view of a first embodiment of a wave charger in accordance with my design;
 FIG. 2 is a front elevational view thereof;
 FIG. 3 is a rear elevational view thereof;
 FIG. 4 is a top plan view thereof;
 FIG. 5 is a bottom view thereof;
 FIG. 6 is a right side elevational view thereof; and
 FIG. 7 is a left side elevational view thereof;
 FIG. 8 is a top, front, right perspective view of a second embodiment of a wave charger in accordance with my design;
 FIG. 9 is a front elevational view thereof;
 FIG. 10 is a rear elevational view thereof;
 FIG. 11 is a top plan view thereof;
 FIG. 12 is a bottom view thereof;
 FIG. 13 is a right side elevational view thereof; and,
 FIG. 14 is a left side elevational view thereof.

The broken lines shown in the drawings are included for the purpose of illustrating unclaimed portions of the wave charger and form no part of the claimed design.

1 Claim, 8 Drawing Sheets

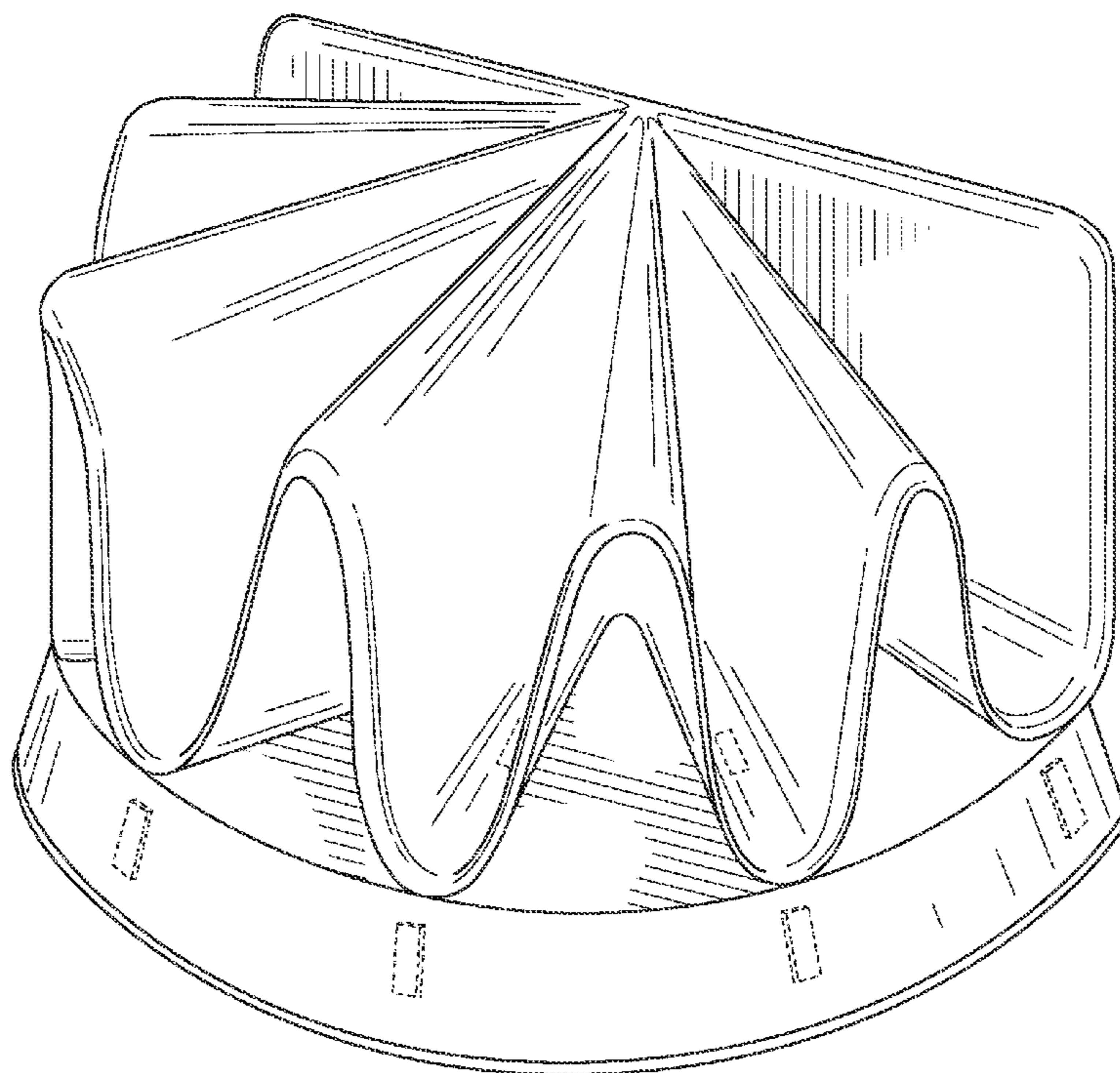

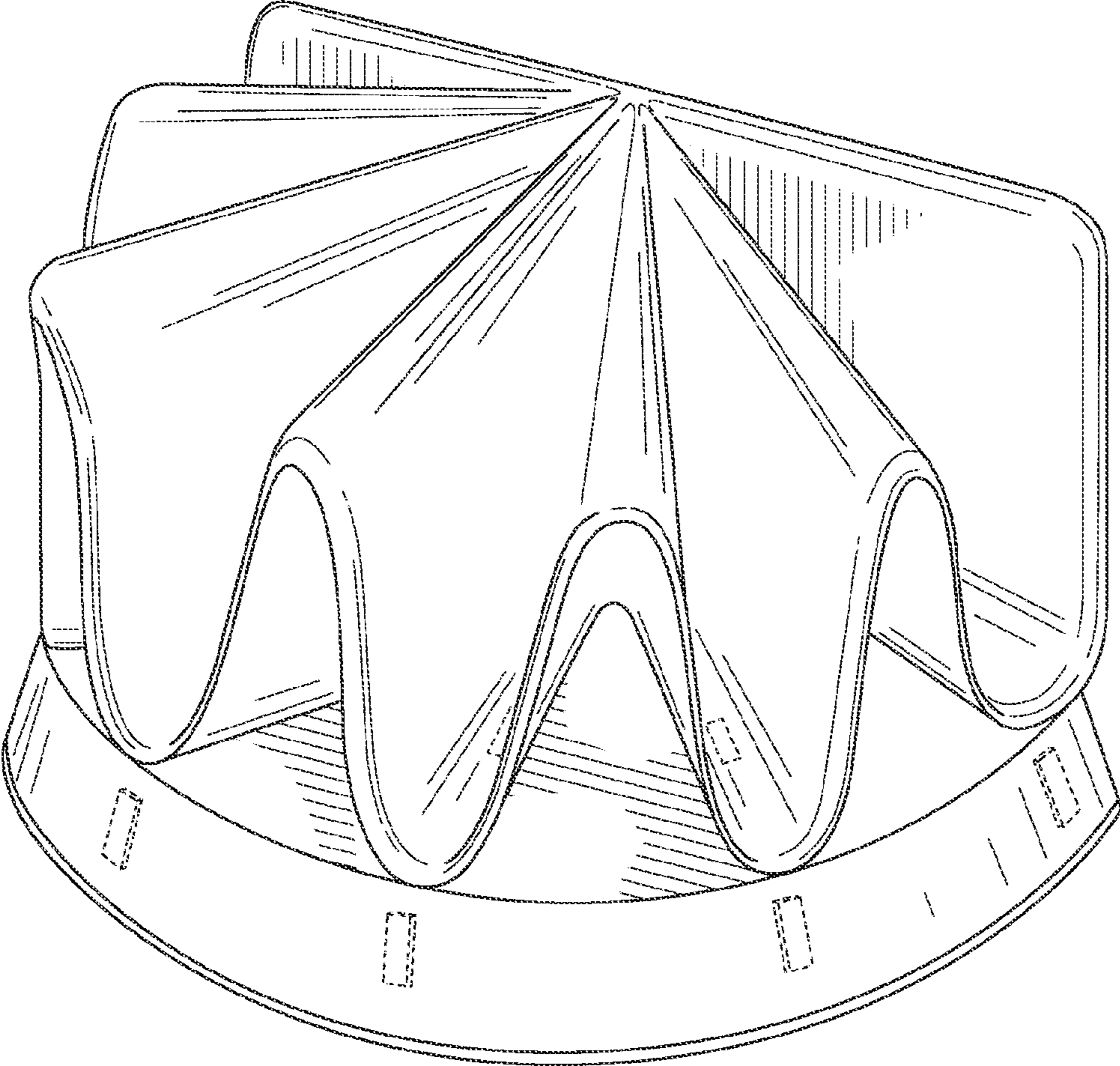

FIG. 1

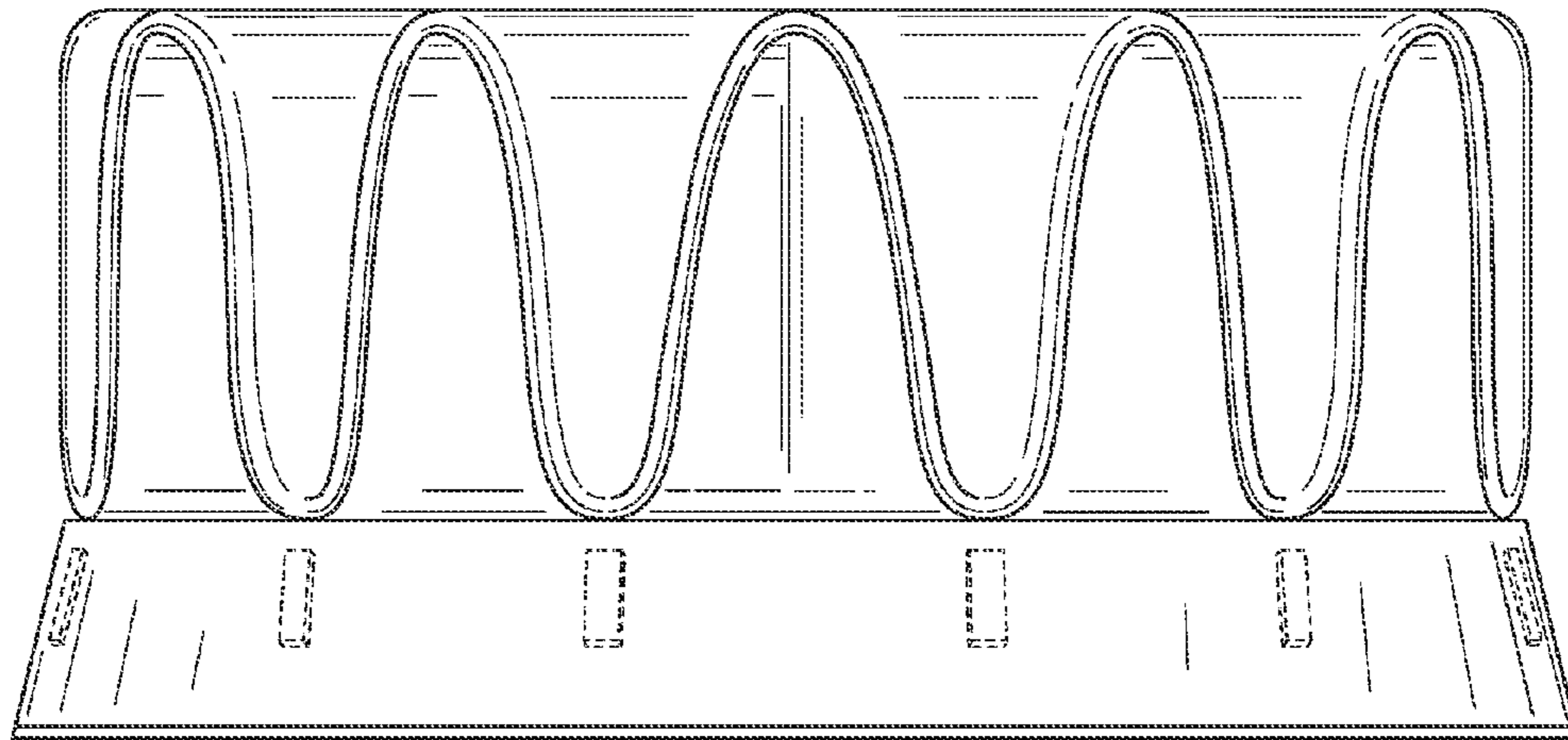

FIG. 2

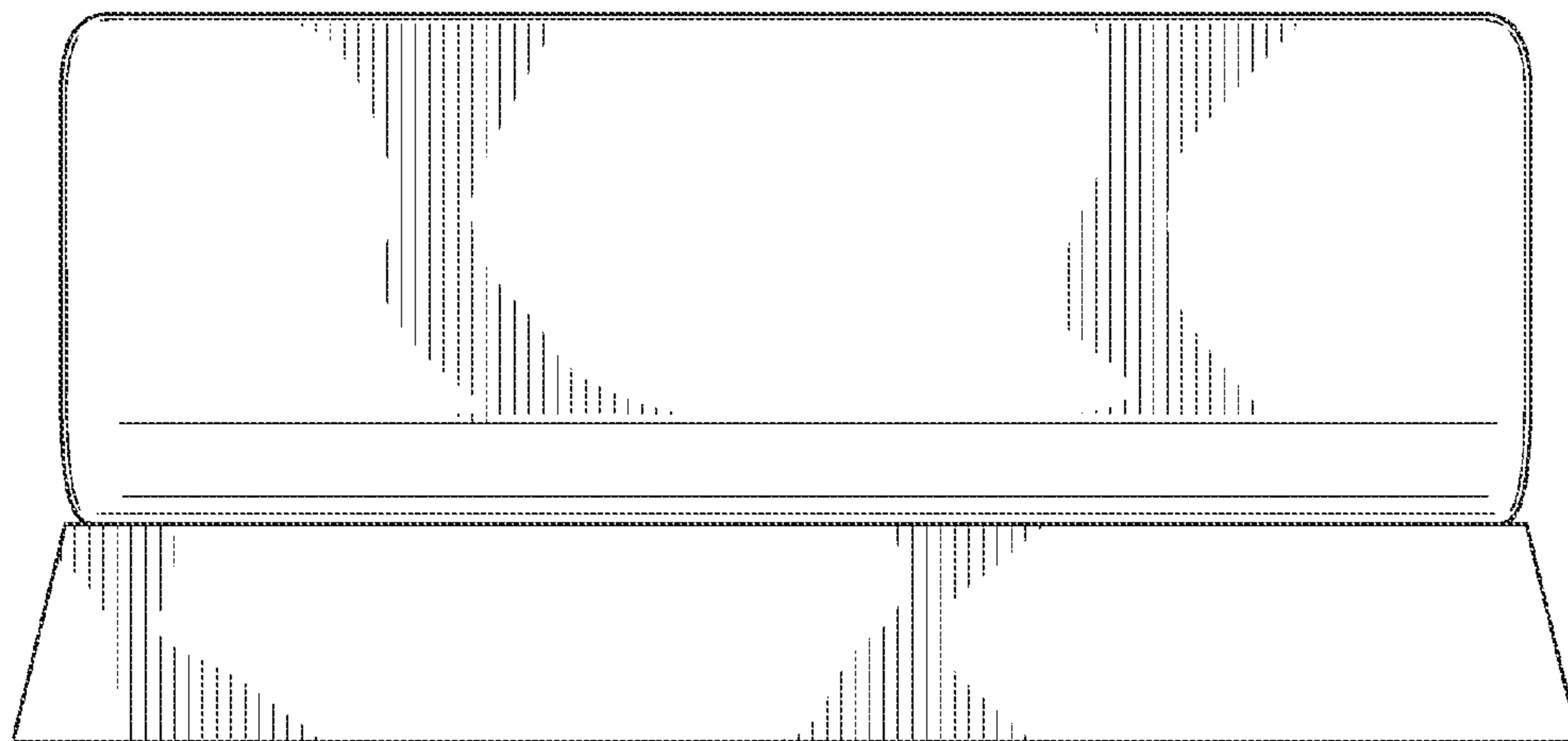

FIG. 3

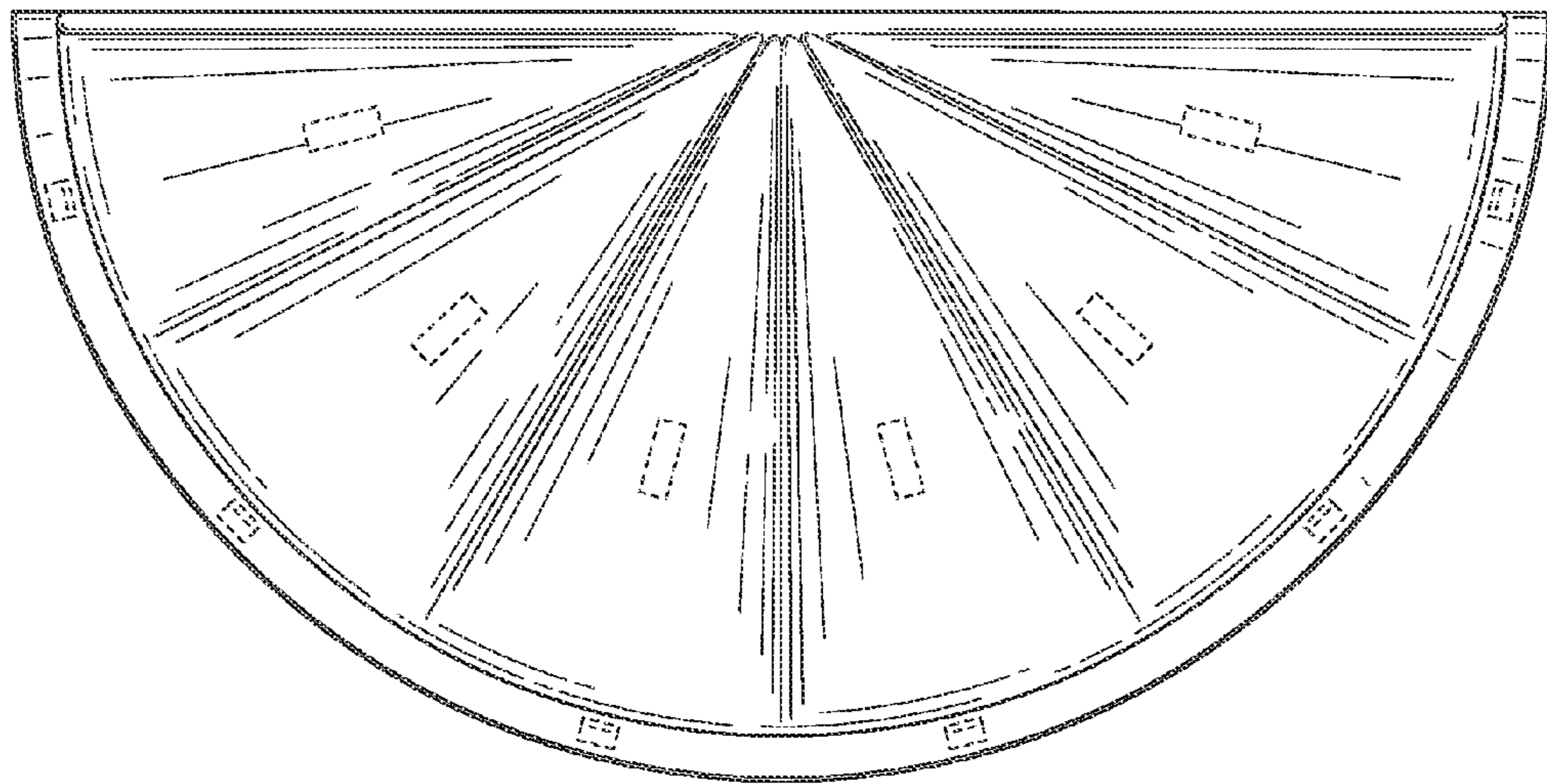

FIG. 4

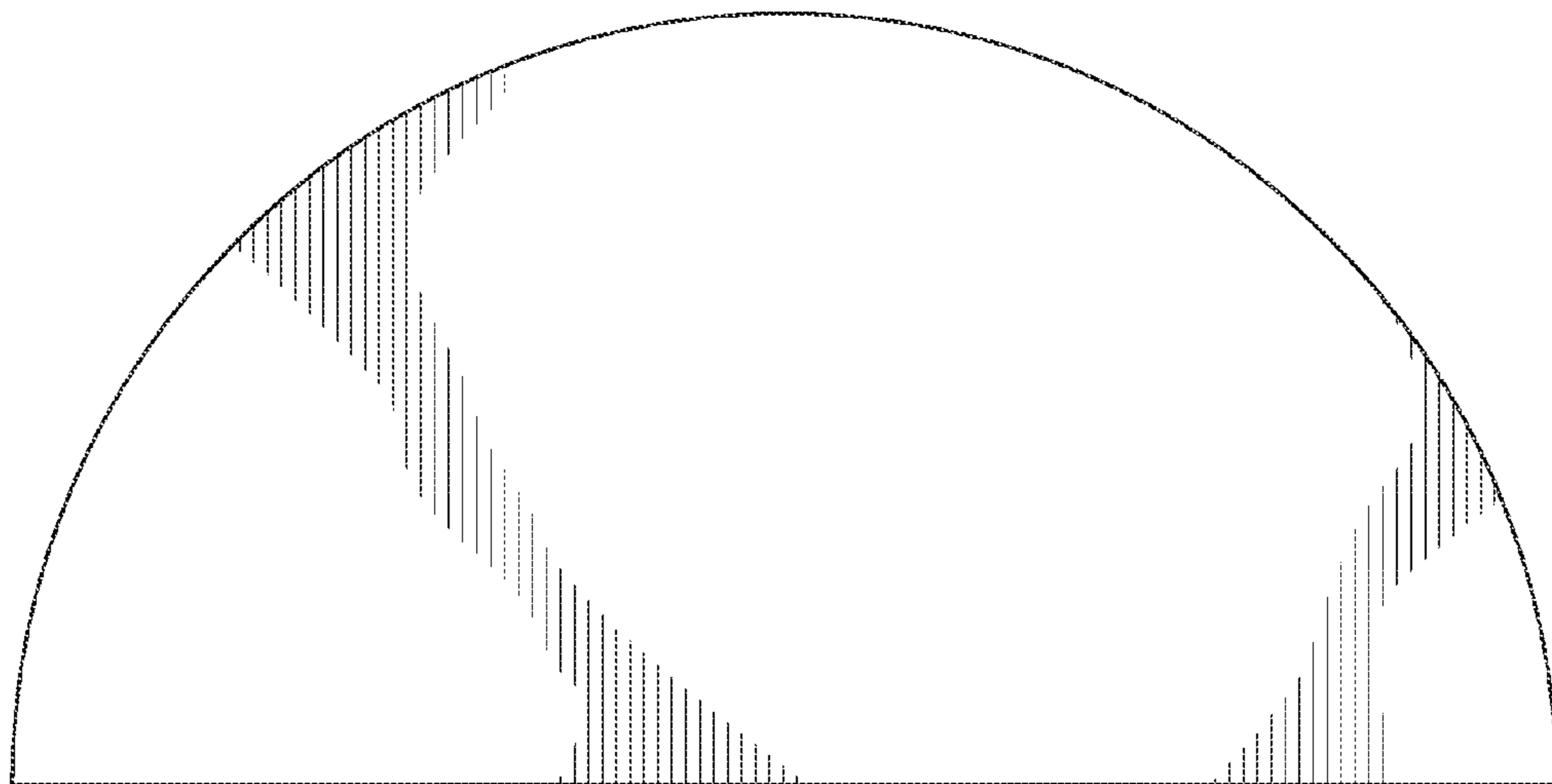

FIG. 5

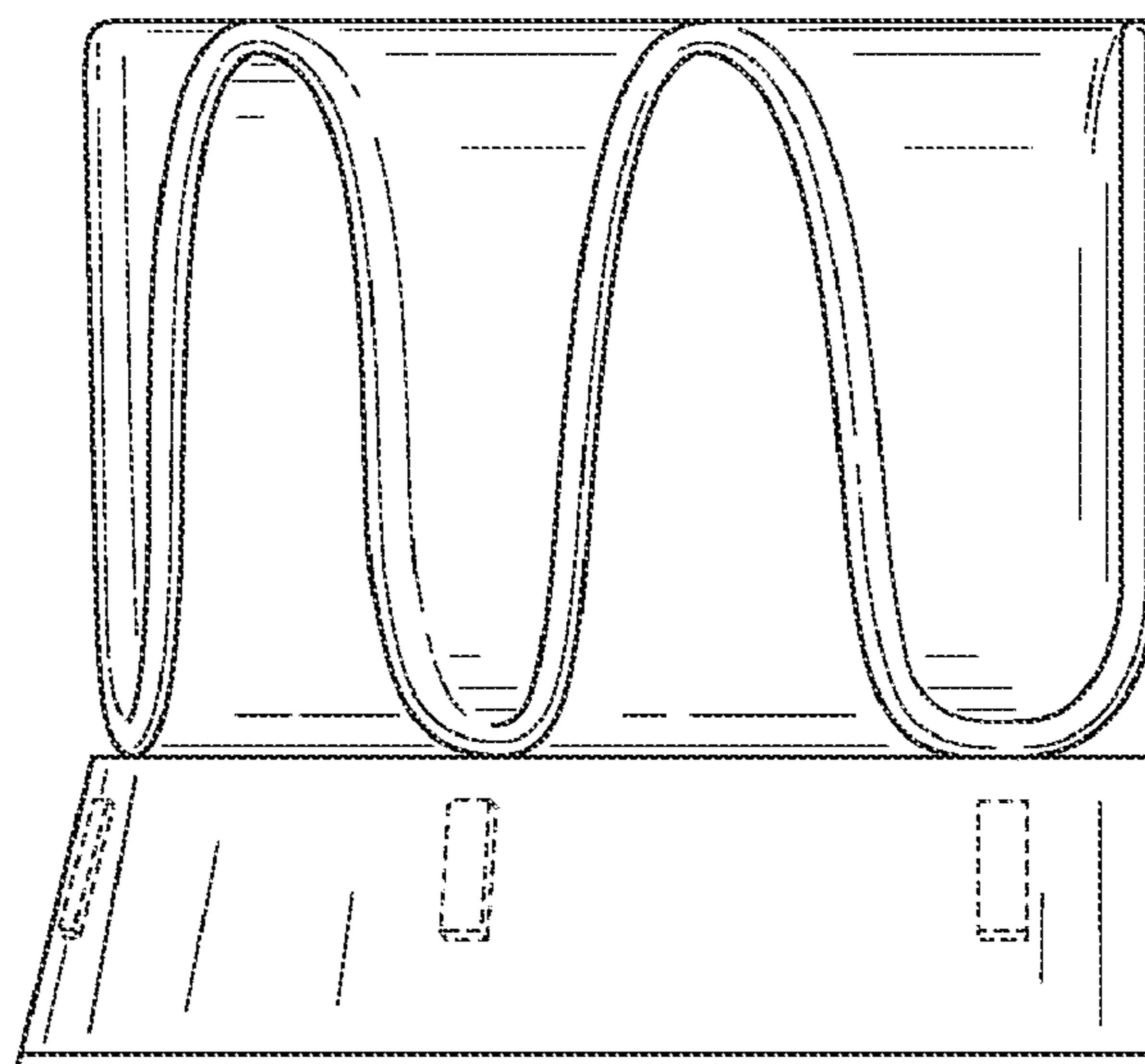

FIG. 6

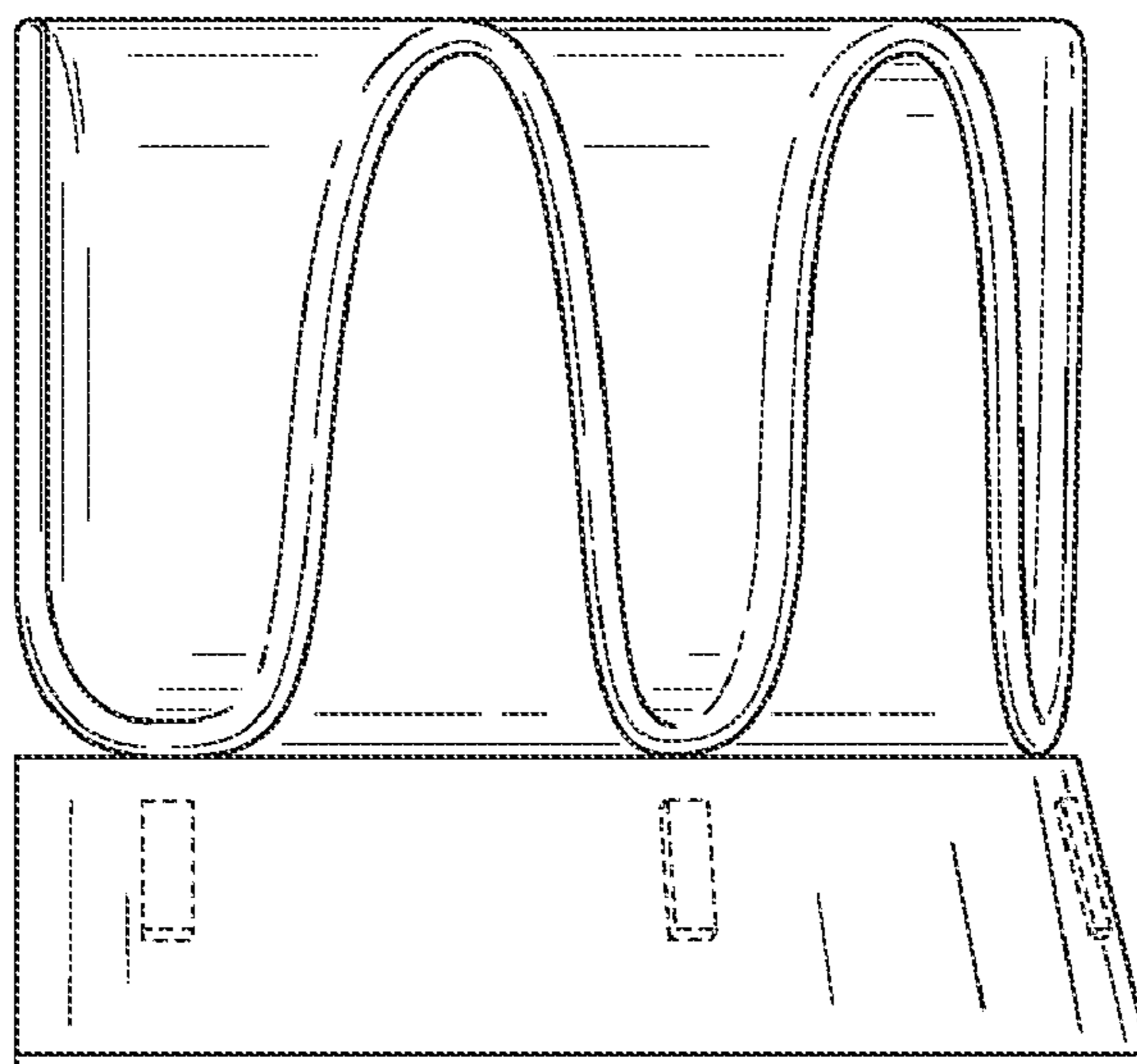

FIG. 7

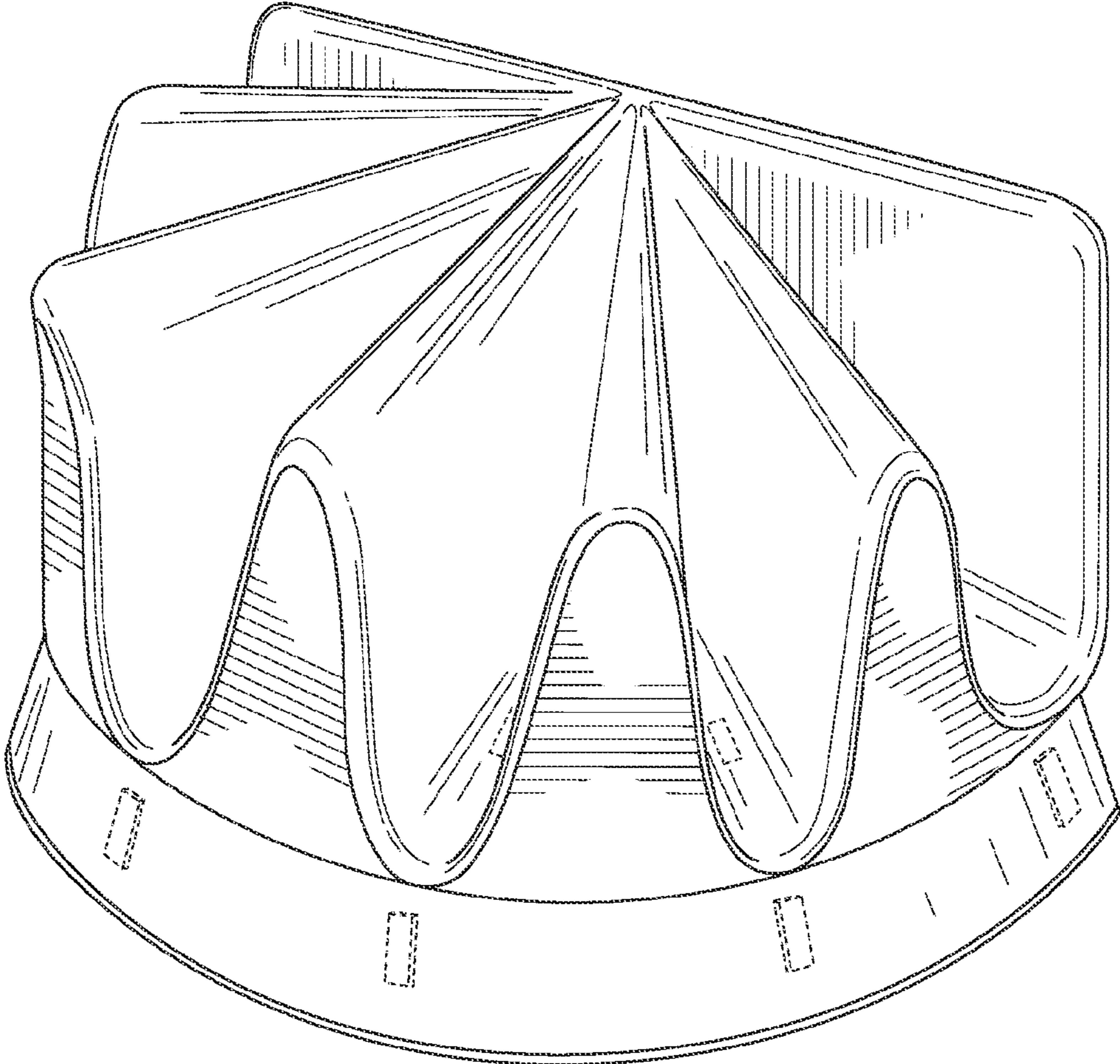

FIG. 8

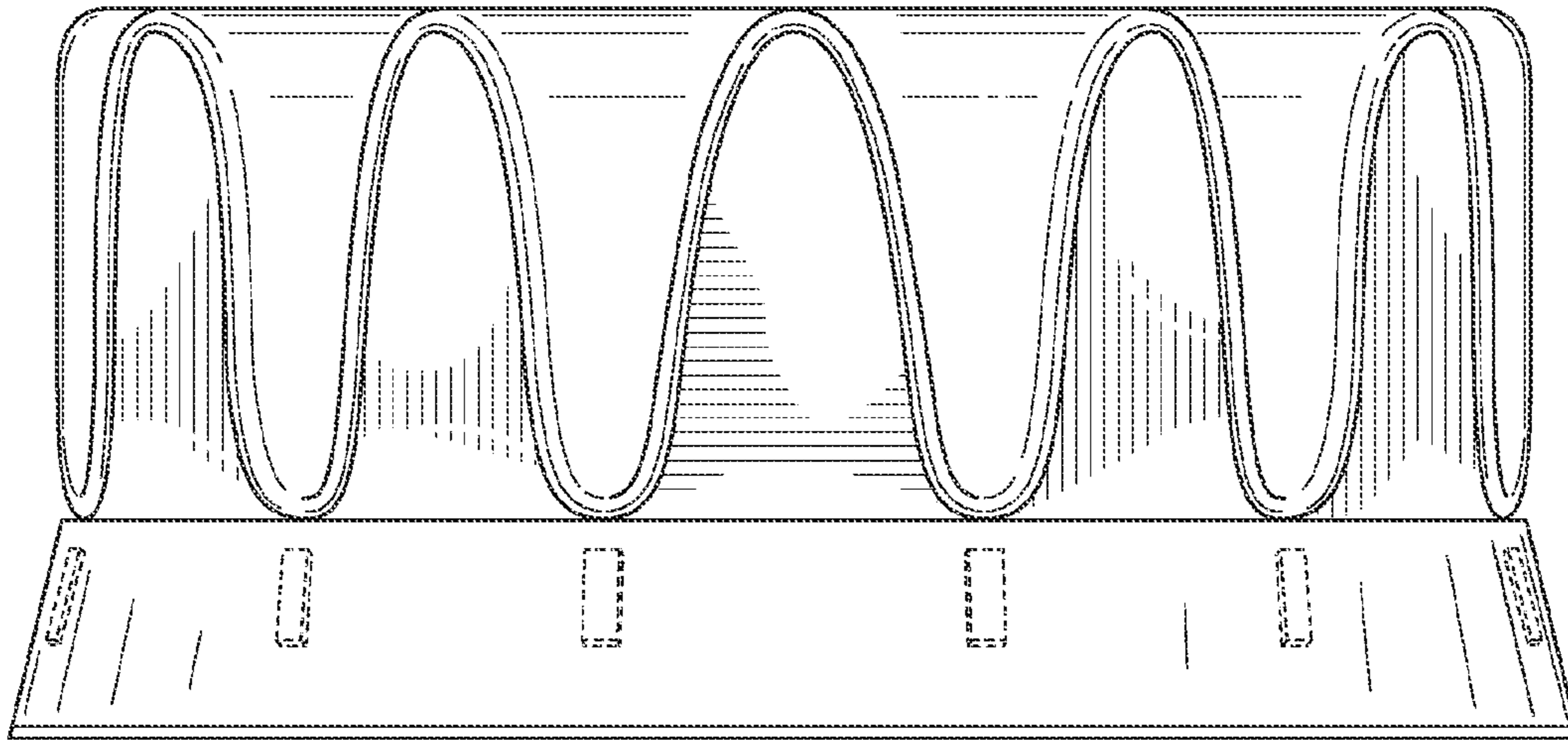

FIG. 9

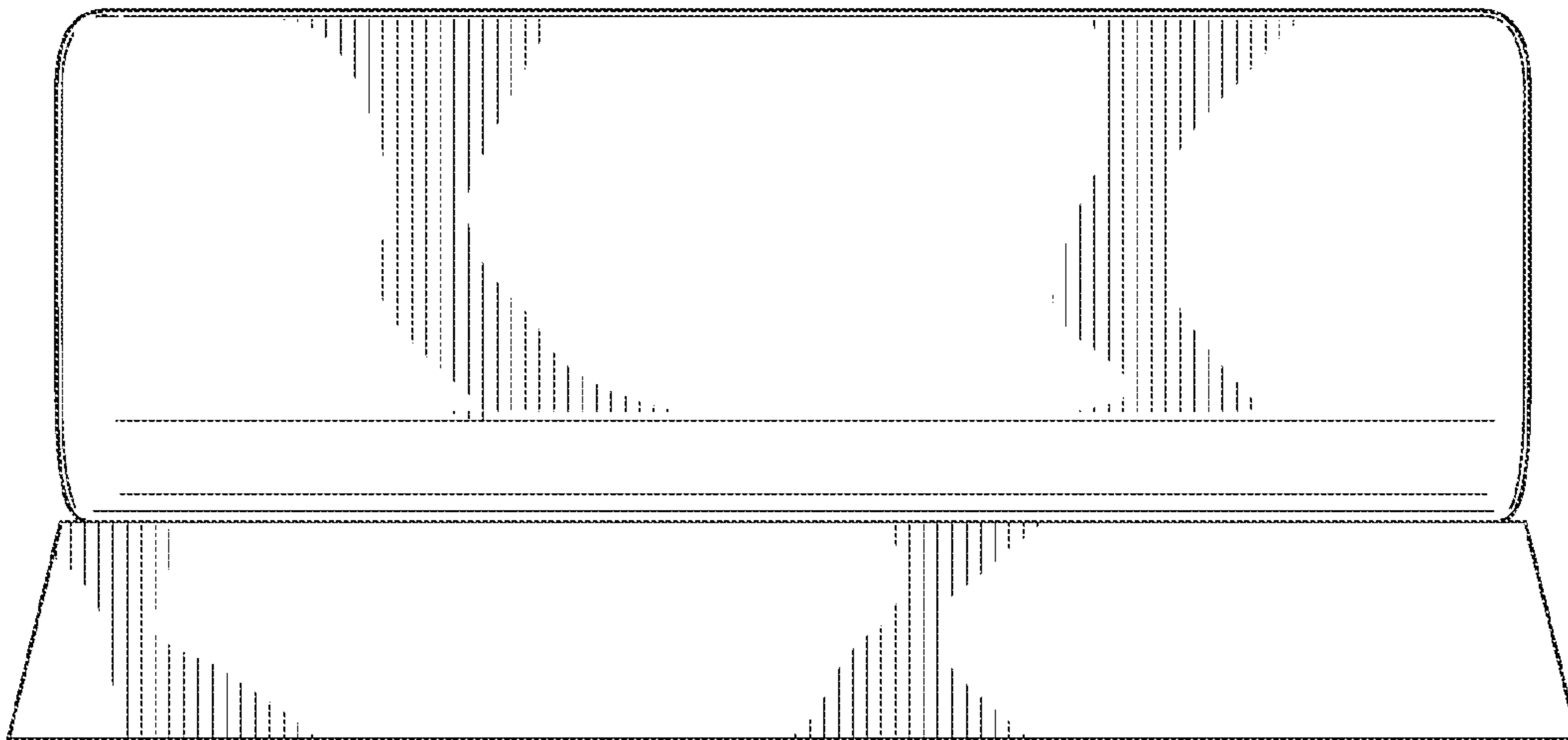

FIG. 10

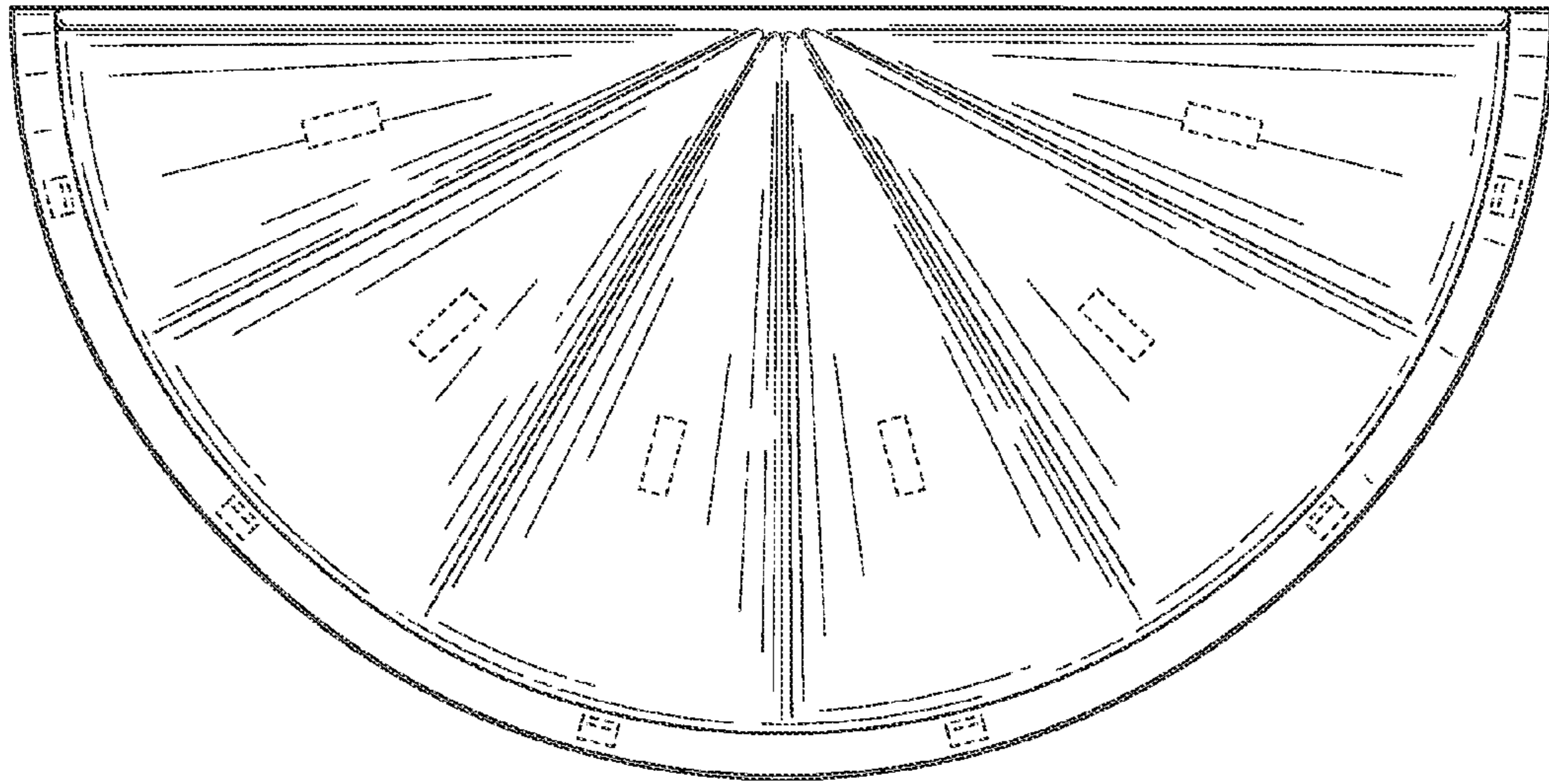

FIG. 11

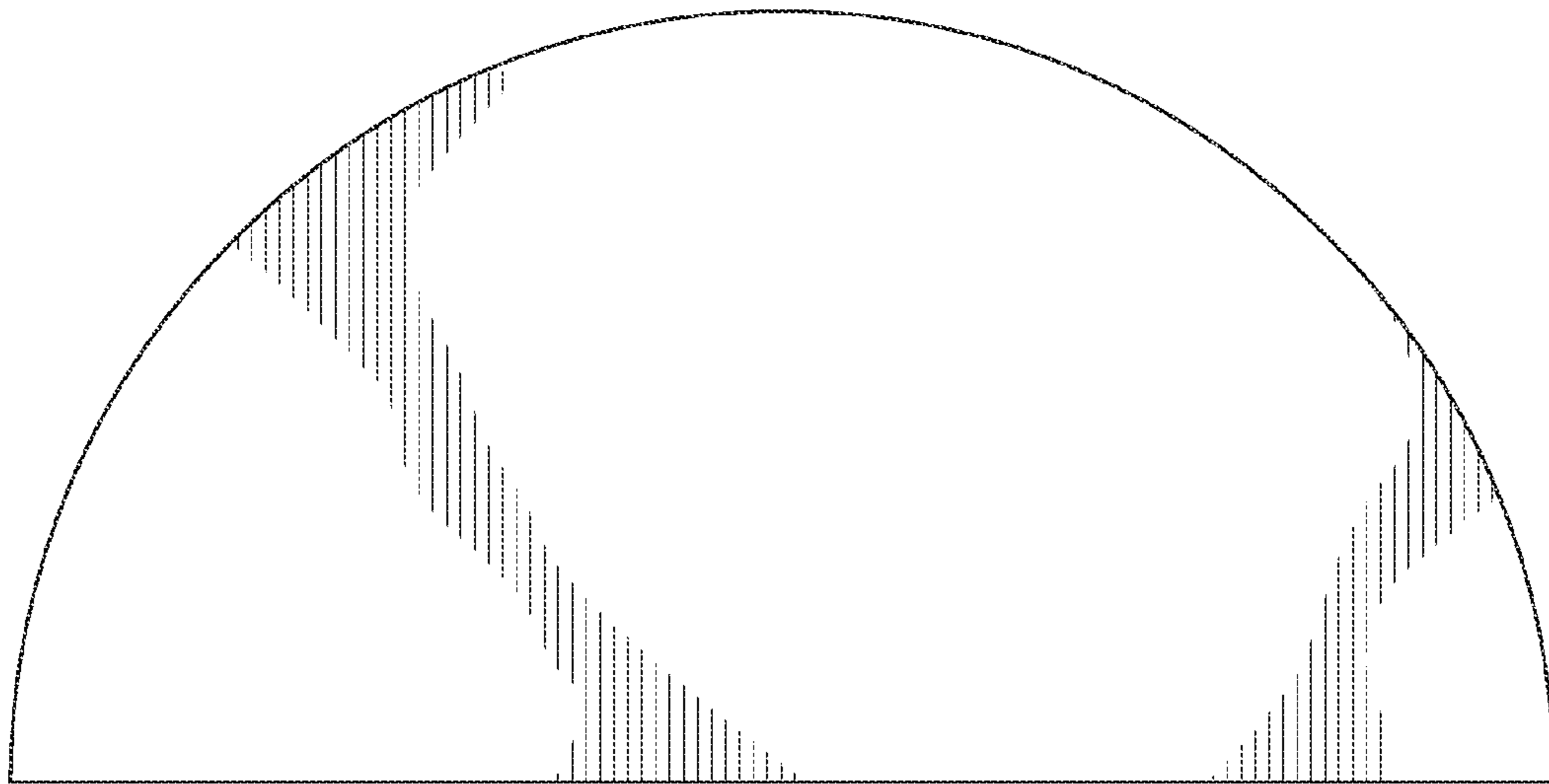

FIG. 12

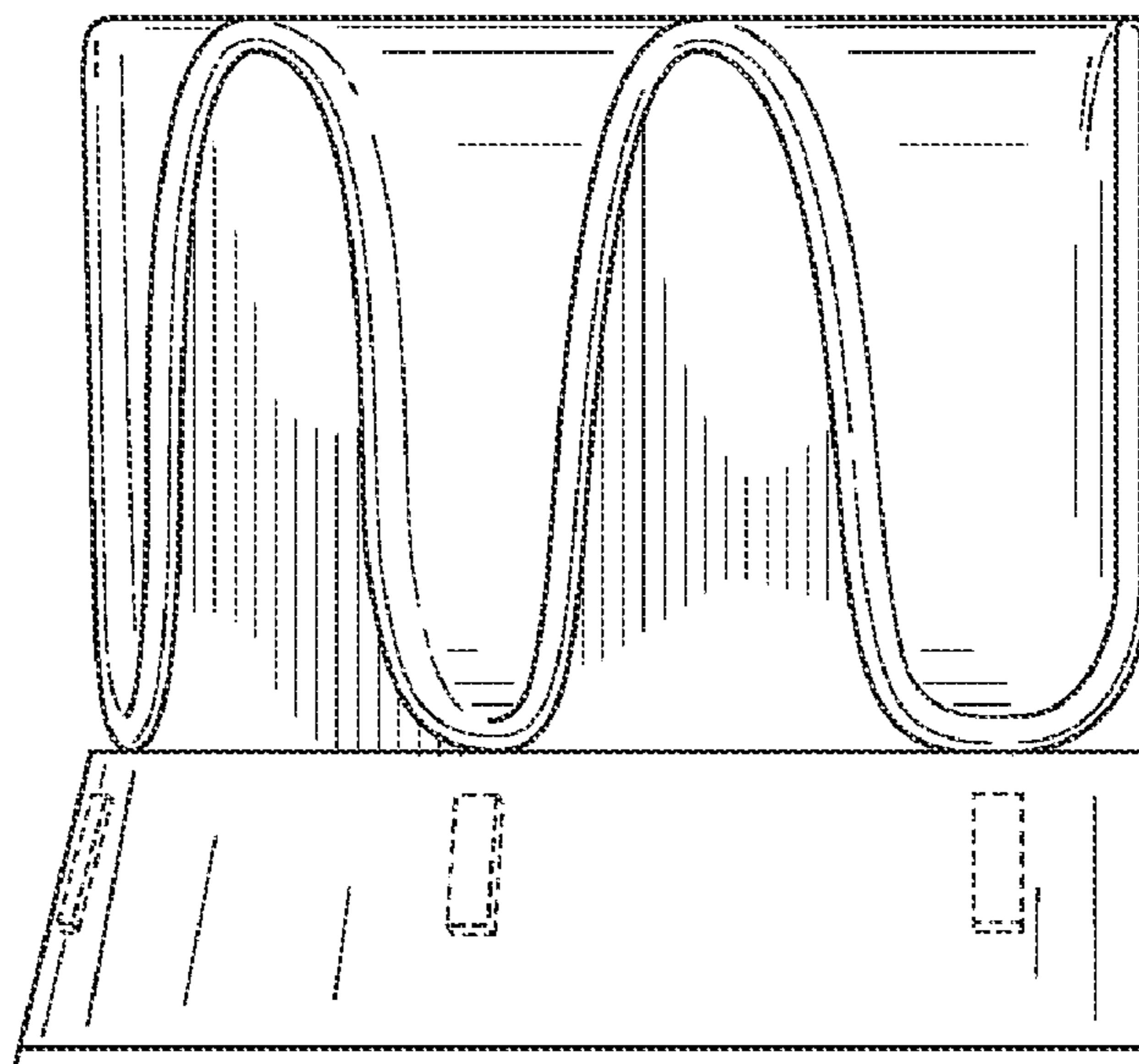

FIG. 13

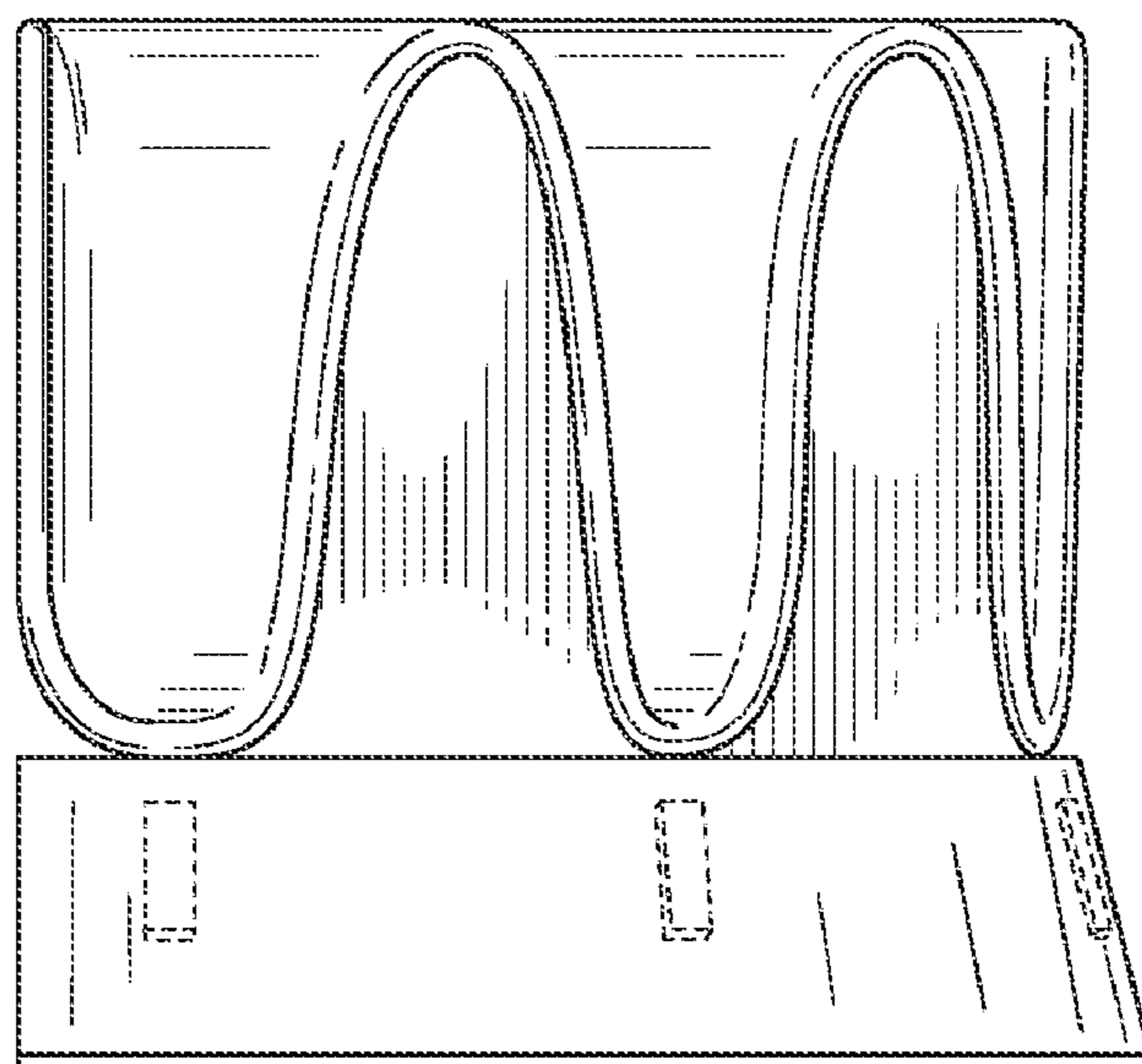

FIG. 14