



US00D642475S

(12) **United States Design Patent**  
**Crutchley et al.**

(10) **Patent No.:** **US D642,475 S**

(45) **Date of Patent:** **\*\* Aug. 2, 2011**

(54) **ADHESIVE DISPENSER**

(75) Inventors: **Shaelyn D. Crutchley**, St. Paul, MN (US); **John W. Frank**, Cottage Grove, MN (US); **Jane E. Harvey**, Coon Rapids, MN (US); **Michael C. Molinet**, Woodbury, MN (US)

(73) Assignee: **3M Innovative Properties Company**, St. Paul, MN (US)

(\*\*) Term: **14 Years**

(21) Appl. No.: **29/367,310**

(22) Filed: **Aug. 5, 2010**

(51) **LOC (9) Cl.** ..... **09-01**

(52) **U.S. Cl.** ..... **D9/542; D9/571; D9/454**

(58) **Field of Classification Search** ..... D9/516, D9/549-550, 558-560, 563, 571-575, 444, D9/454-455, 499, 530, 537, 539, 542-543, D9/723-724, 737-739, 741, 751-752, 754; D24/224; 215/379, 382-384; 220/660, 662, 220/669, 675; D19/66; D4/114

See application file for complete search history.

(56) **References Cited**

**U.S. PATENT DOCUMENTS**

D199,606 S \* 11/1964 Waterman ..... D24/115  
D207,189 S \* 3/1967 Thomson ..... D9/558  
D217,803 S \* 6/1970 Douglas ..... D9/571  
D221,213 S \* 7/1971 Weckman ..... D9/542  
D226,551 S \* 3/1973 Weckman ..... D9/542

D257,828 S \* 1/1981 Strand et al. .... D9/563  
D266,702 S \* 10/1982 Lagny ..... D24/115  
D424,115 S \* 5/2000 Kuboshima ..... D19/66  
D428,342 S \* 7/2000 Stoller ..... D9/542  
D484,808 S \* 1/2004 Thierjung et al. .... D9/530  
D485,480 S \* 1/2004 Rushe  
D546,189 S \* 7/2007 Costello et al. .... D9/542  
D564,892 S \* 3/2008 di Robilant et al. .... D9/546

**FOREIGN PATENT DOCUMENTS**

TW M337466 8/2008

\* cited by examiner

*Primary Examiner* — Ian Simmons

*Assistant Examiner* — Dana L Sipos

(74) *Attorney, Agent, or Firm* — Lisa P. Fulton

(57) **CLAIM**

The ornamental design for an adhesive dispenser, as shown and described.

**DESCRIPTION**

FIG. 1 is a perspective view of an adhesive dispenser showing the new design;

FIG. 2 is a front elevational view, the opposite side being a mirror image thereof;

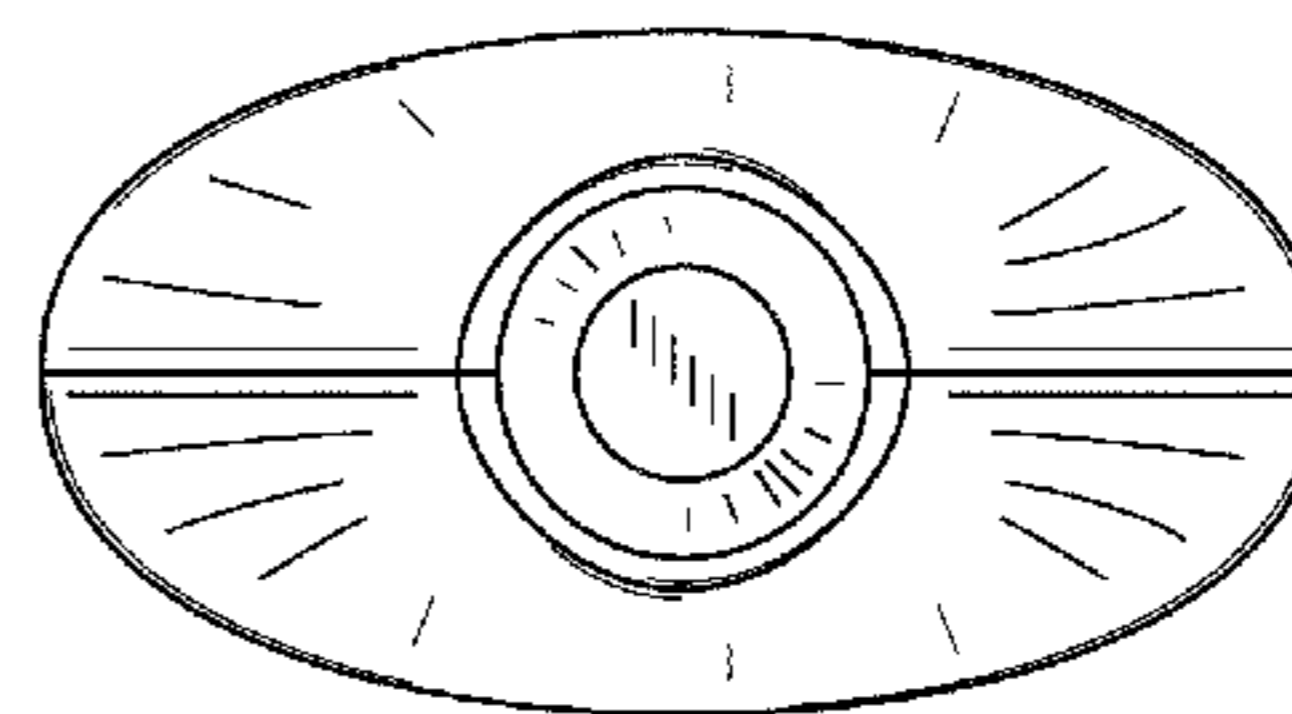
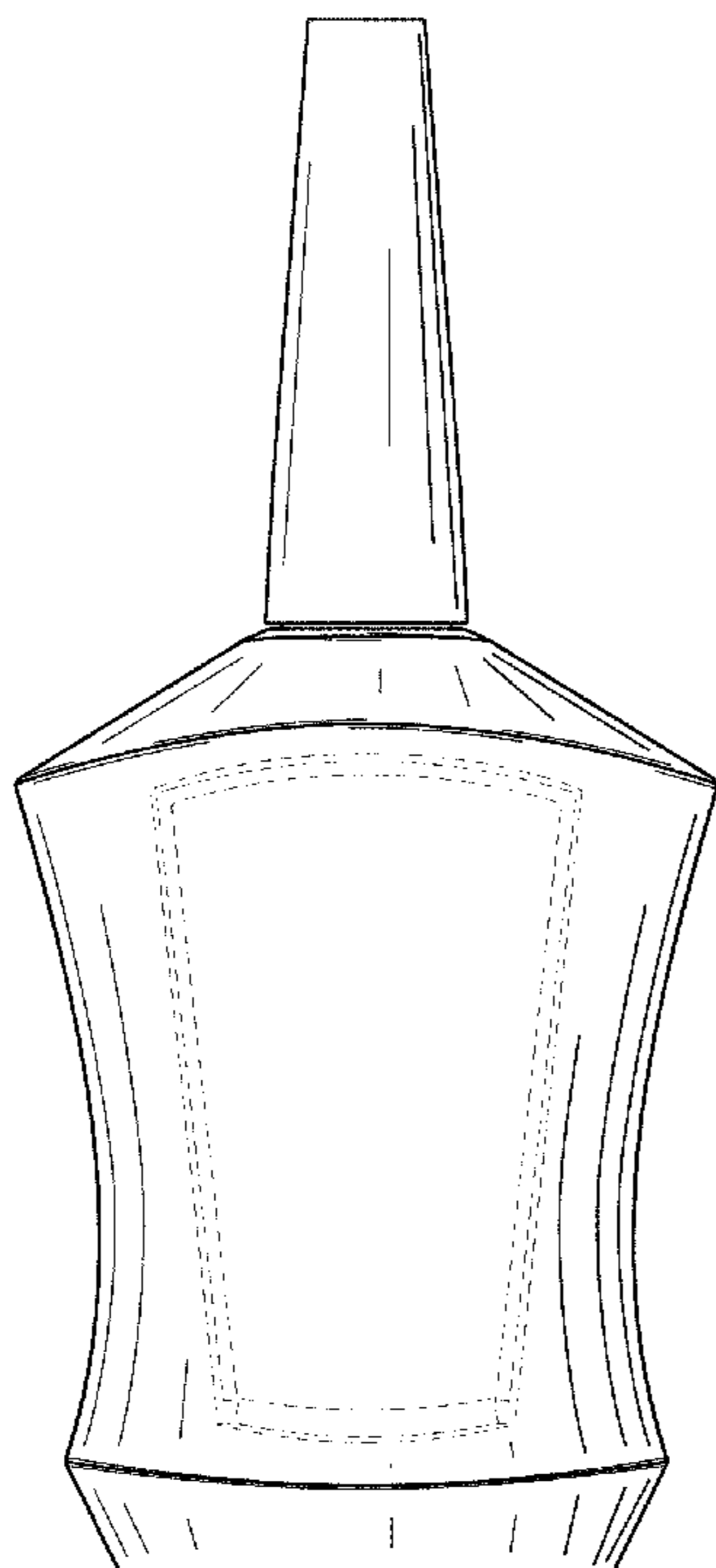
FIG. 3 is a side view, the opposite side being a mirror image thereof;

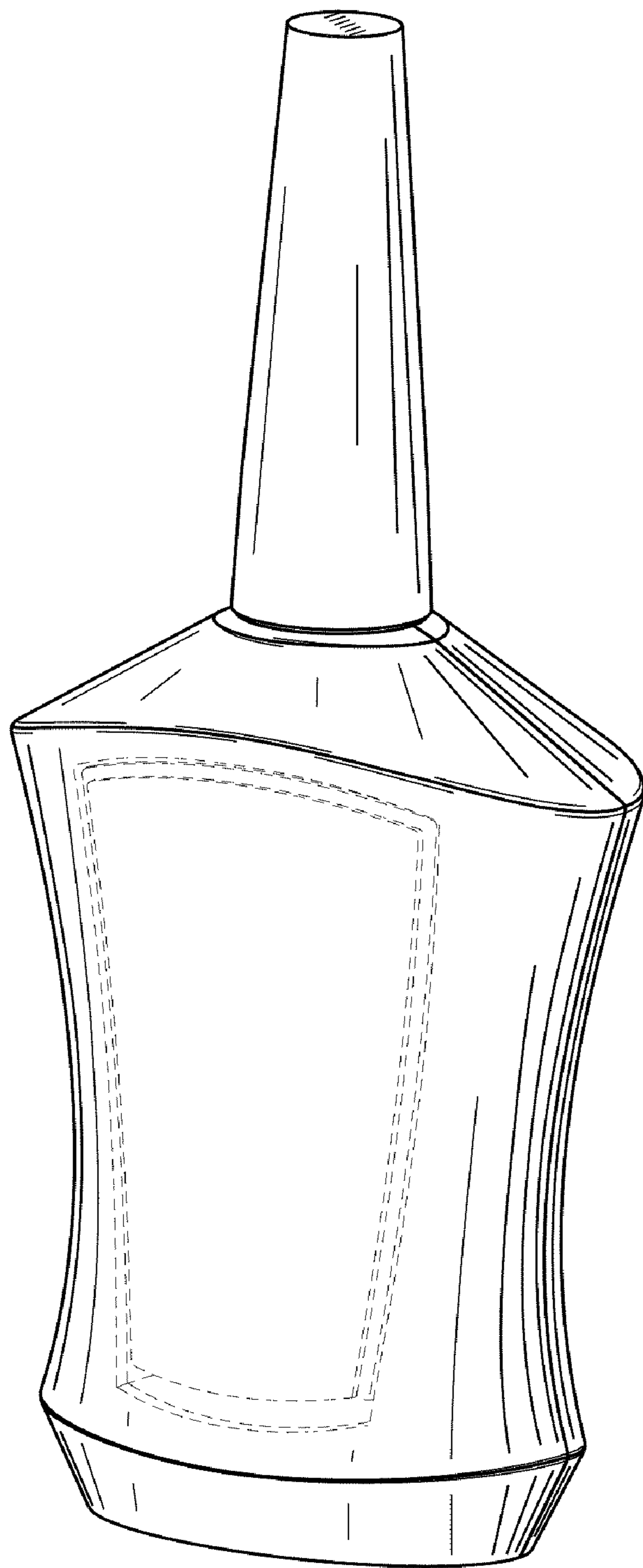
FIG. 4 is a top view thereof; and,

FIG. 5 is a bottom view thereof.

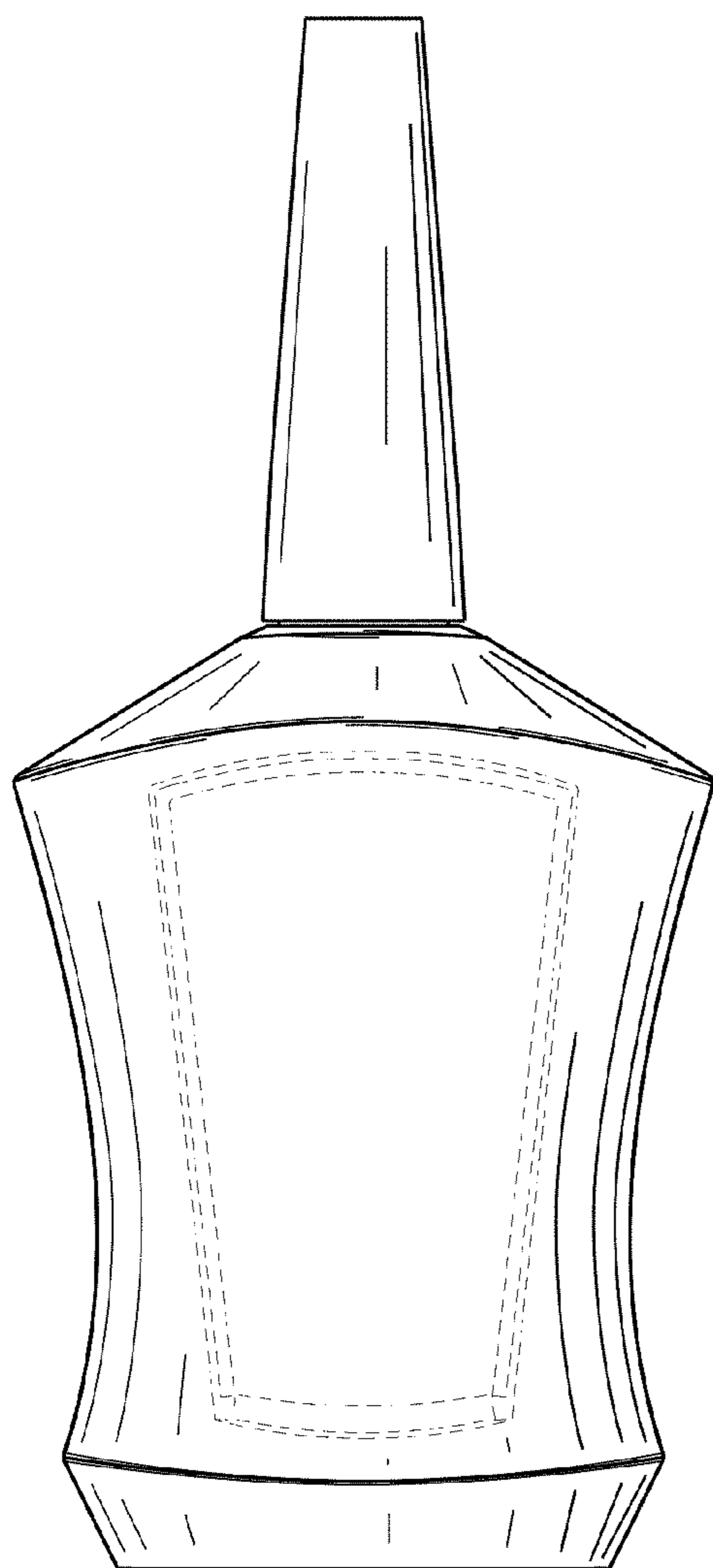
The broken line showing of a button on the adhesive dispenser is included for illustrative purposes only and forms no part of the claimed design.

**1 Claim, 3 Drawing Sheets**

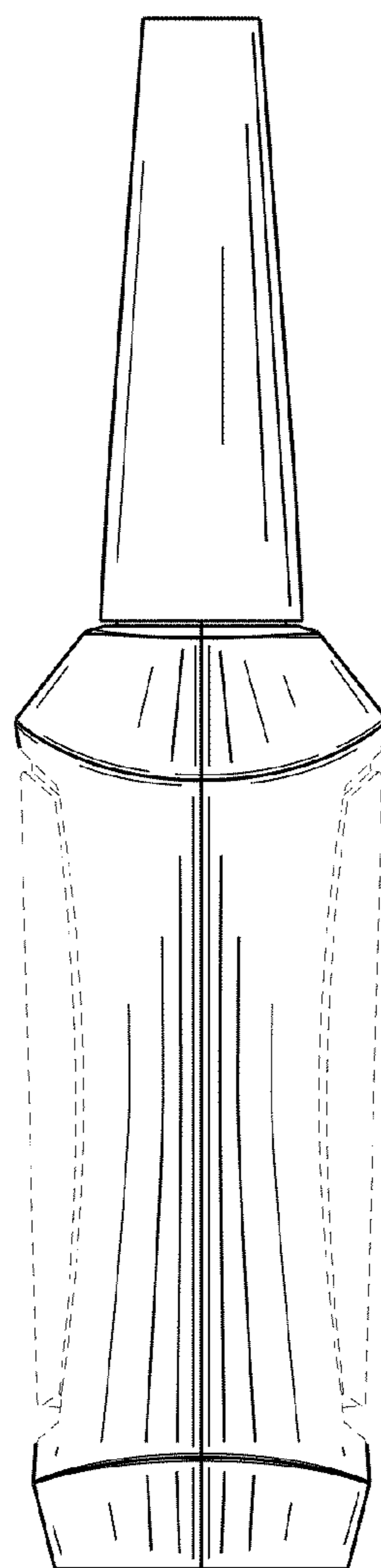




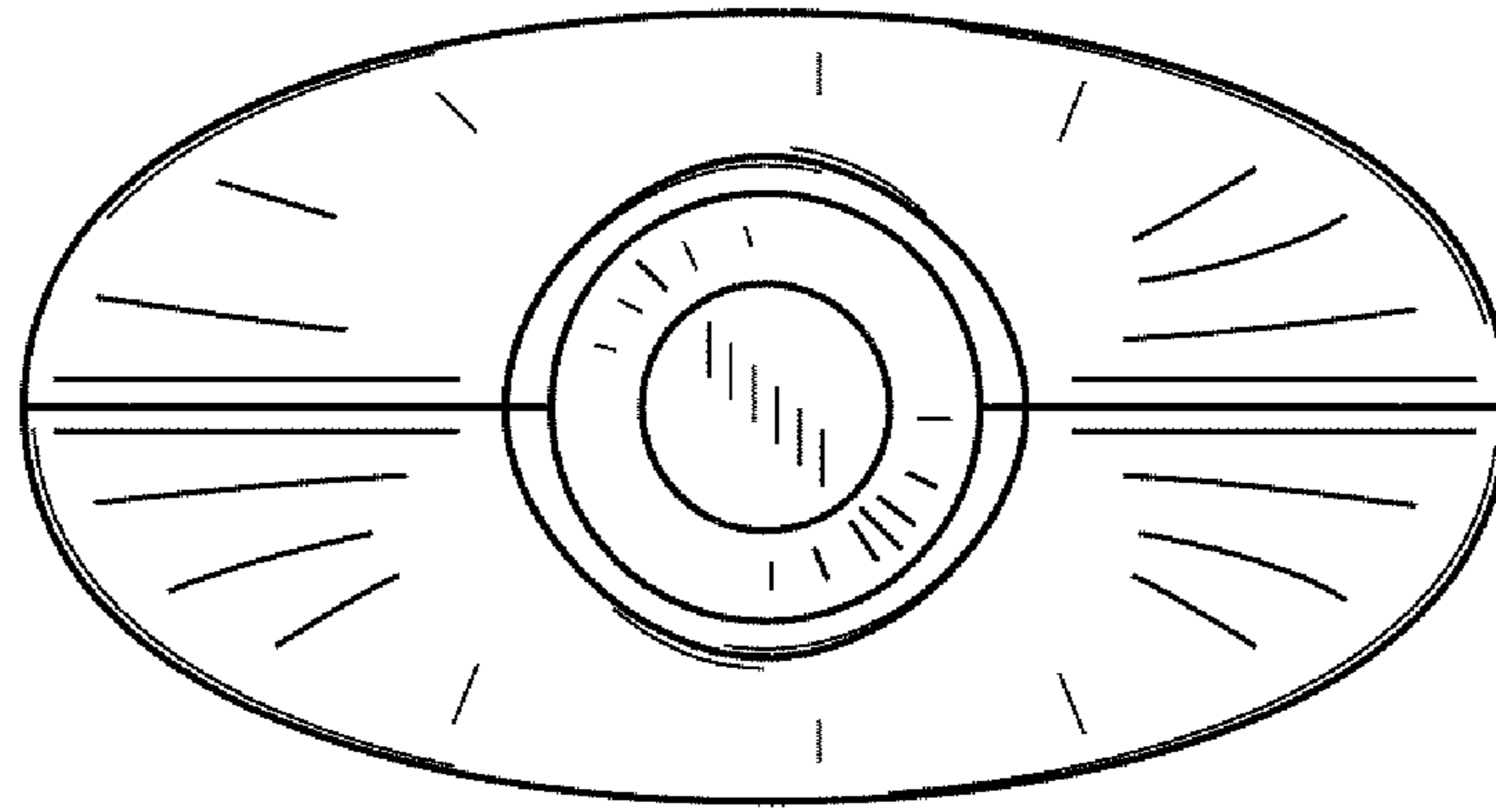
**FIG. 1**



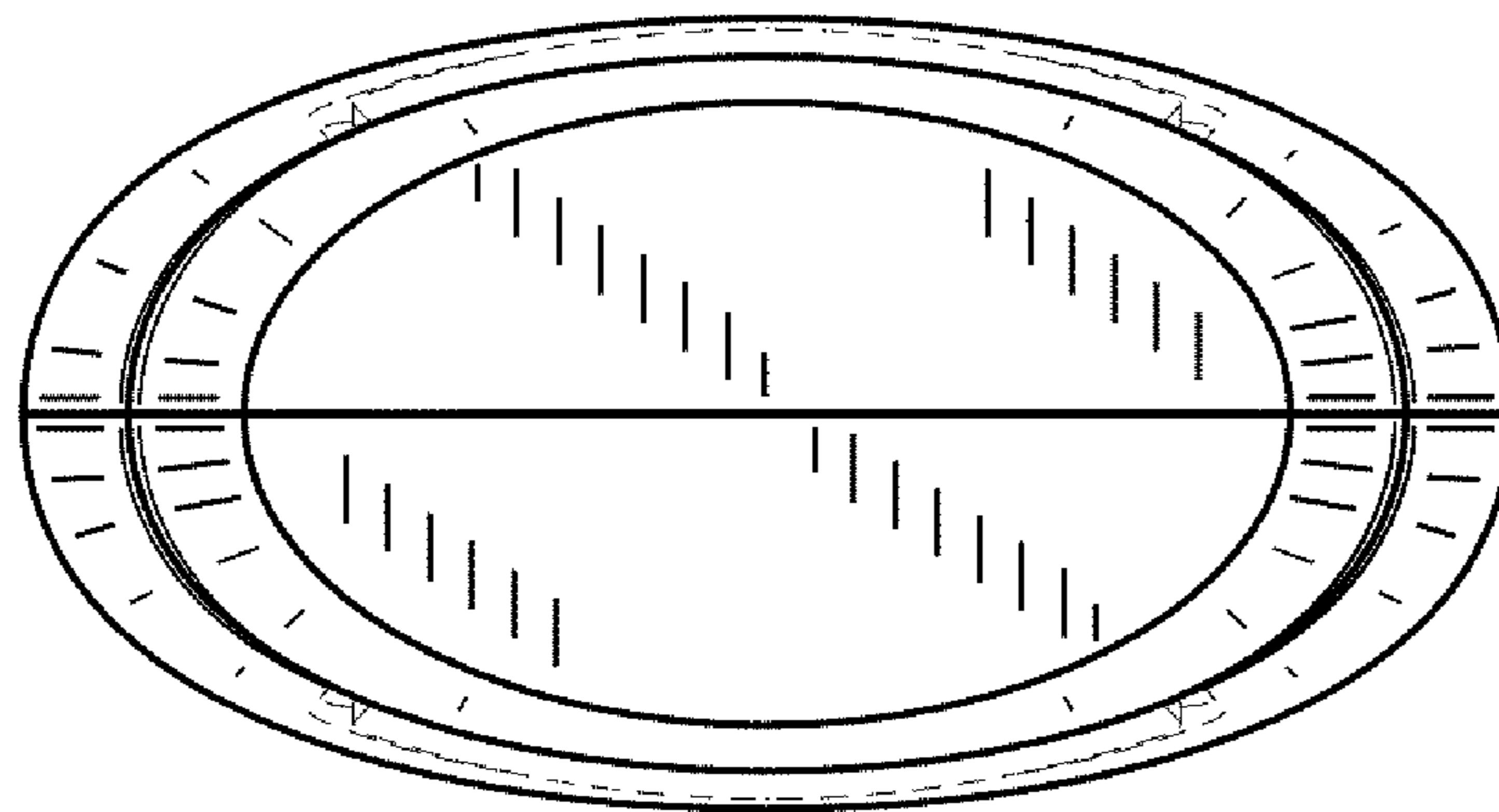
**FIG. 2**



**FIG. 3**



**FIG. 4**



**FIG. 5**