



US00D642450S

(12) **United States Design Patent**
Freese

(10) **Patent No.:** **US D642,450 S**
(45) **Date of Patent:** **** Aug. 2, 2011**

(54) **DUAL-CONFIGURATION HANGER**

(75) Inventor: **Lawrence O. Freese**, Charlotte, NC (US)

(73) Assignee: **BRICA, Inc.**, Charlotte, NC (US)

(**) Term: **14 Years**

(21) Appl. No.: **29/383,608**

(22) Filed: **Jan. 20, 2011**

Related U.S. Application Data

(63) Continuation-in-part of application No. 13/009,308, filed on Jan. 19, 2011.

(60) Provisional application No. 61/296,266, filed on Jan. 19, 2010.

(51) **LOC (9) Cl.** **08-05**

(52) **U.S. Cl.** **D8/367**

(58) **Field of Classification Search** D8/367, D8/323, 382, 328, 356, 354, 372, 1; D12/115, D12/317, 162; 63/8, 7, 12, 15, 1.14; D6/323; 248/301-304, 175, 63; 70/59; 24/588.1, 24/601, 599.9, 598.1, 599.6, 592.11, 601.5, 24/129 R, 600.9; 402/35; 114/218, 114; 294/137, 158, 82.19; 410/101; 182/3; D11/210, D11/3; D9/752; D19/32; D3/207
See application file for complete search history.

(56) **References Cited**

U.S. PATENT DOCUMENTS

| | | | | |
|---------------|---------|---------------------|-------|---------|
| D42,689 S * | 7/1912 | Kerr | | D8/368 |
| 2,473,086 A | 6/1949 | Montero | | |
| 3,773,288 A | 11/1973 | Bolton | | |
| 3,860,210 A | 1/1975 | Berardinelli et al. | | |
| 3,861,633 A | 1/1975 | Rappleye et al. | | |
| 4,118,001 A | 10/1978 | Serkez | | |
| 4,210,302 A | 7/1980 | Serkez | | |
| 4,940,261 A * | 7/1990 | Somers Vine | | 285/112 |
| 4,978,093 A | 12/1990 | Kennedy | | |
| 5,094,417 A | 3/1992 | Creed | | |

(Continued)

OTHER PUBLICATIONS

The Mommy Hook® stroller hanger. Internet web page www.themommyhook.com. Downloaded Nov. 20, 2011. Effective date unknown.

Primary Examiner — Cynthia Underwood

(74) *Attorney, Agent, or Firm* — Carter & Schnedler, P.A.

(57) **CLAIM**

The ornamental design for a dual-configuration hanger, as shown and described.

DESCRIPTION

FIG. 1 is a three-dimensional view of a dual-configuration hanger in its closed configuration;
FIG. 2 is a front elevational view of the dual-configuration hanger in its closed configuration;
FIG. 3 is a rear elevational view of the dual-configuration hanger in its closed configuration;
FIG. 4 is a bottom view of the dual-configuration hanger in its closed configuration;
FIG. 5 is a top plan view of the dual-configuration hanger in its closed configuration;
FIG. 6 is a left side elevational view of the dual-configuration hanger in its closed configuration;
FIG. 7 is a right side elevational view of the dual-configuration hanger in its closed configuration;
FIG. 8 is a three-dimensional view of the dual-configuration hanger of FIG. 1 in its open configuration;
FIG. 9 is a front elevational view of the dual-configuration hanger in its open configuration;
FIG. 10 is a rear elevational view of the dual-configuration hanger in its open configuration;
FIG. 11 is a bottom view of the dual-configuration hanger in its open configuration;
FIG. 12 is a top plan view of the dual-configuration hanger in its open configuration;
FIG. 13 is a left side elevational view of the dual-configuration hanger in its open configuration; and,
FIG. 14 is a right side elevational view of the dual-configuration hanger in its open configuration.
The broken lines define the boundary of the claimed design and form no part thereof.

1 Claim, 10 Drawing Sheets

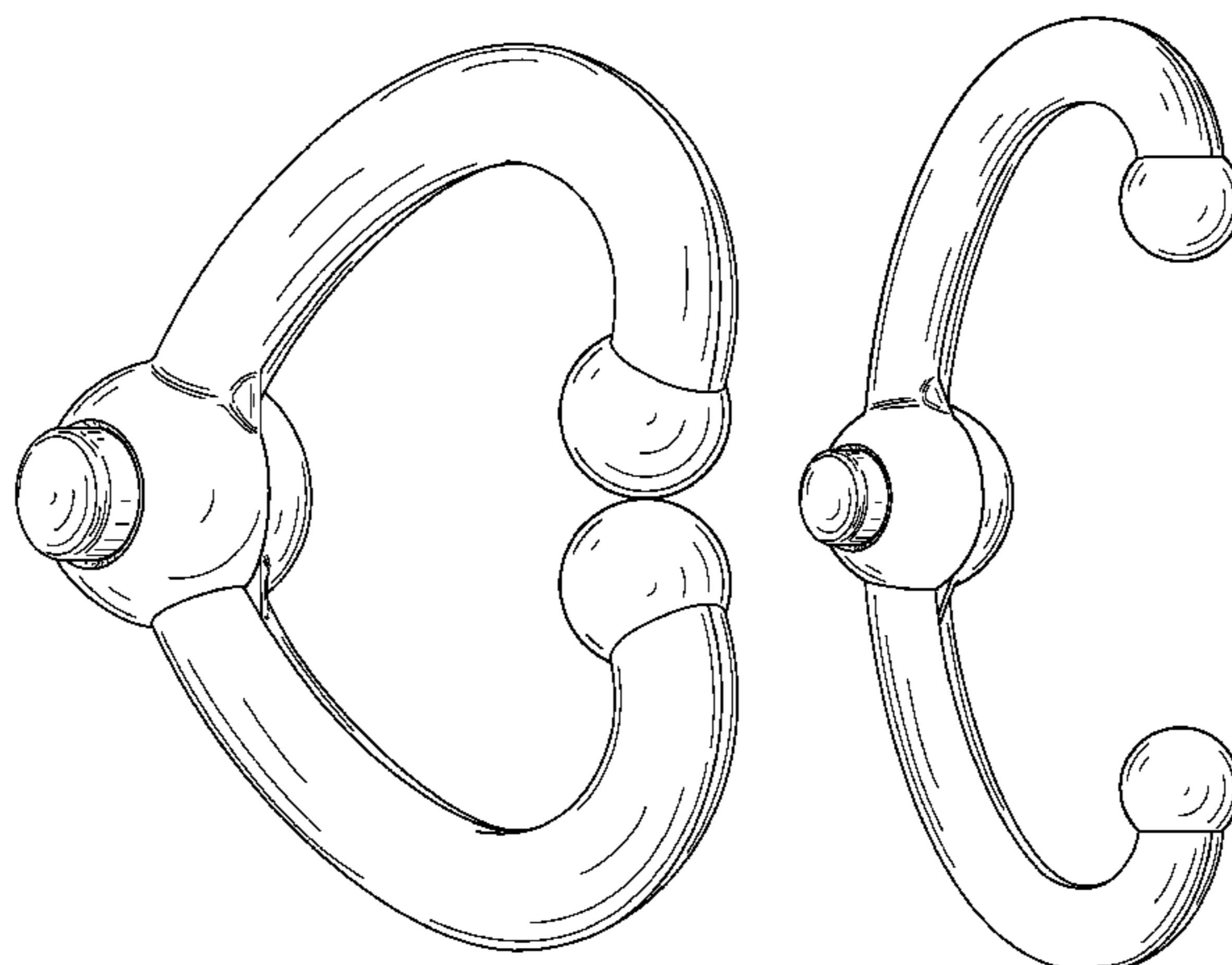

US D642,450 S

Page 2

U.S. PATENT DOCUMENTS

| | | | | | | |
|--------------|------|---------|------------------|---------|--|--|
| 5,984,250 | A | 11/1999 | Connor | | | |
| D425,317 | S * | 5/2000 | Snell | D6/323 | | |
| D426,425 | S * | 6/2000 | Hermanski | D7/400 | | |
| D426,764 | S | 6/2000 | Szabo | | | |
| 6,347,822 | B1 * | 2/2002 | Miller, Jr. | 294/158 | | |
| D464,867 | S * | 10/2002 | Samelson | D8/367 | | |
| 7,175,143 | B1 | 2/2007 | Ho | | | |
| 7,347,065 | B1 * | 3/2008 | DeGolyer | 63/7 | | |
| D569,714 | S | 5/2008 | Stewart et al. | | | |
| 7,458,488 | B2 | 12/2008 | Bass et al. | | | |
| D588,444 | S | 3/2009 | Shamlian | | | |
| D597,825 | S * | 8/2009 | Ho | D8/367 | | |
| 7,644,900 | B2 | 1/2010 | Yap et al. | | | |
| D632,952 | S * | 2/2011 | Dablemont | D8/367 | | |
| 2002/0129619 | A1 * | 9/2002 | Wolff | 63/7 | | |
| 2005/0082319 | A1 | 4/2005 | Caroselli et al. | | | |
| 2008/0236195 | A1 * | 10/2008 | Woebke | 63/1.14 | | |

* cited by examiner

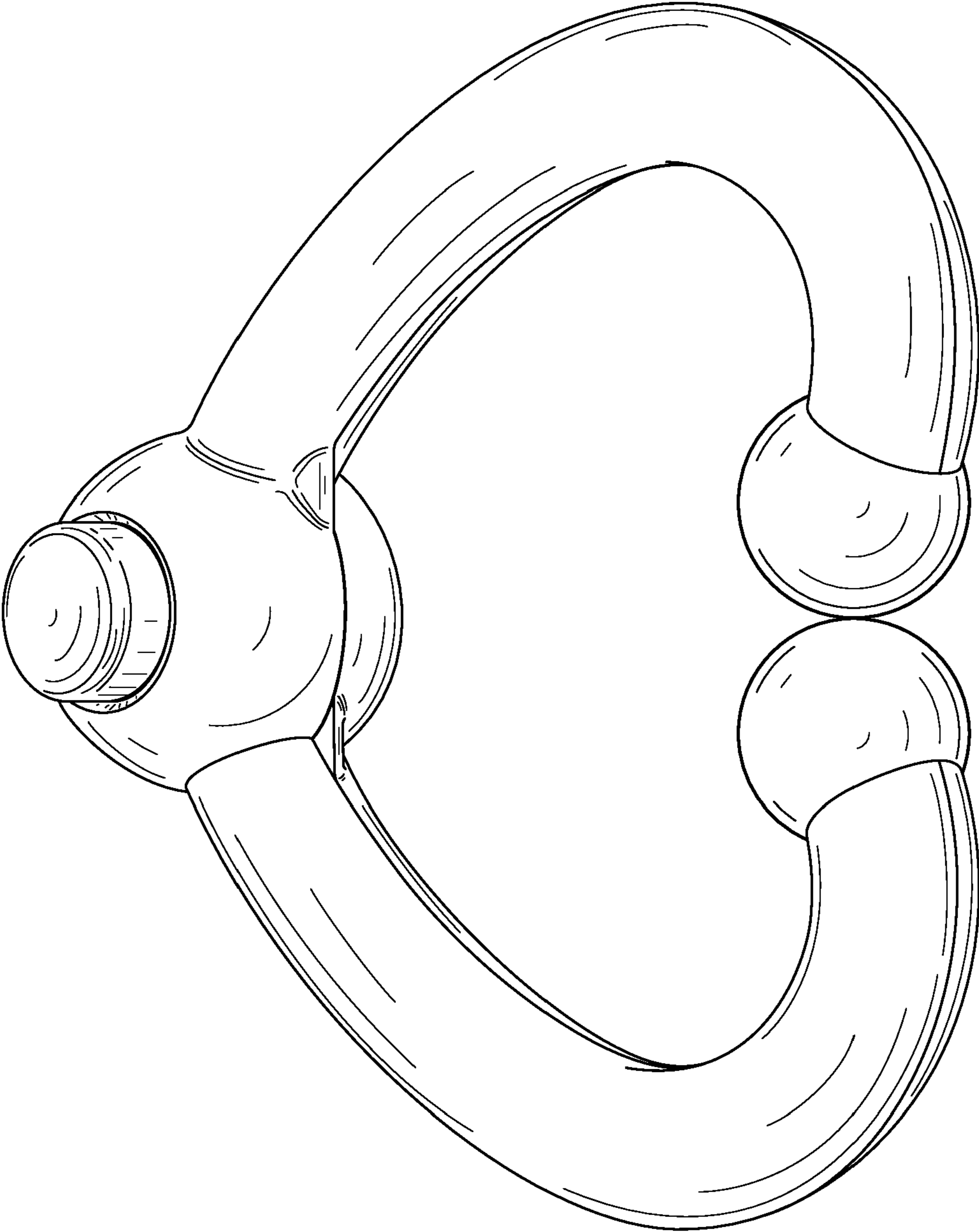

FIG. 1

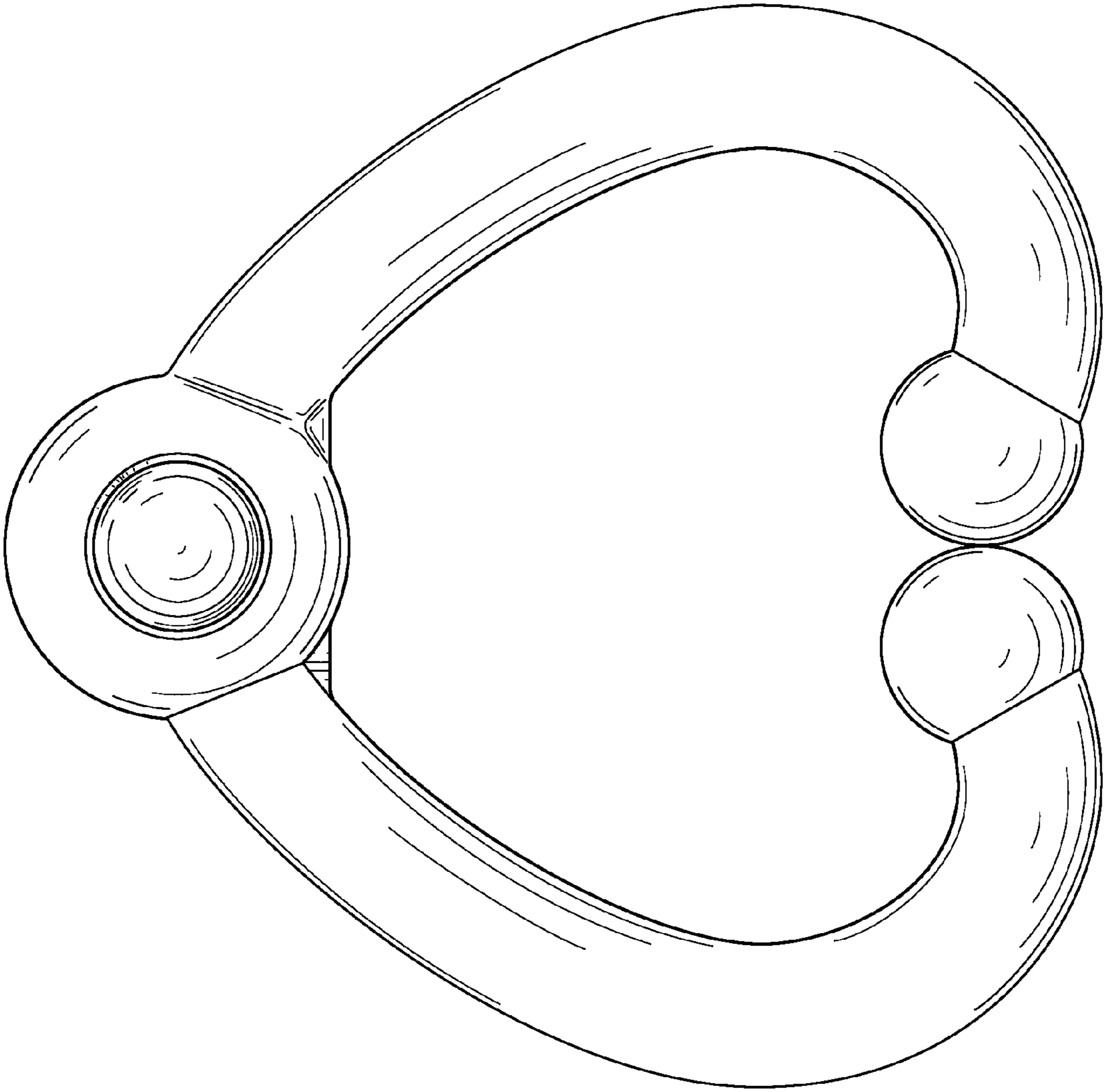

FIG. 2

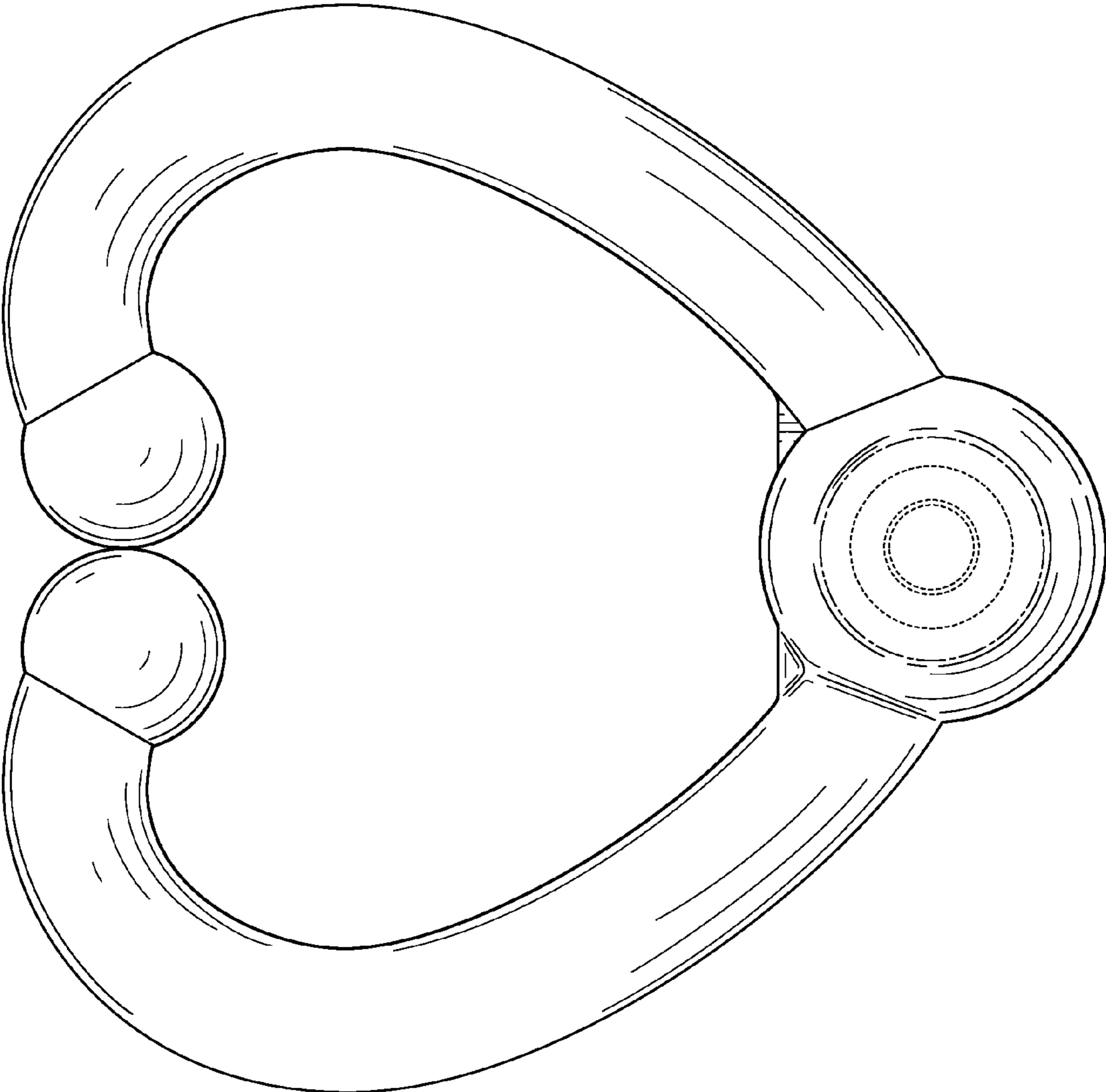

FIG. 3

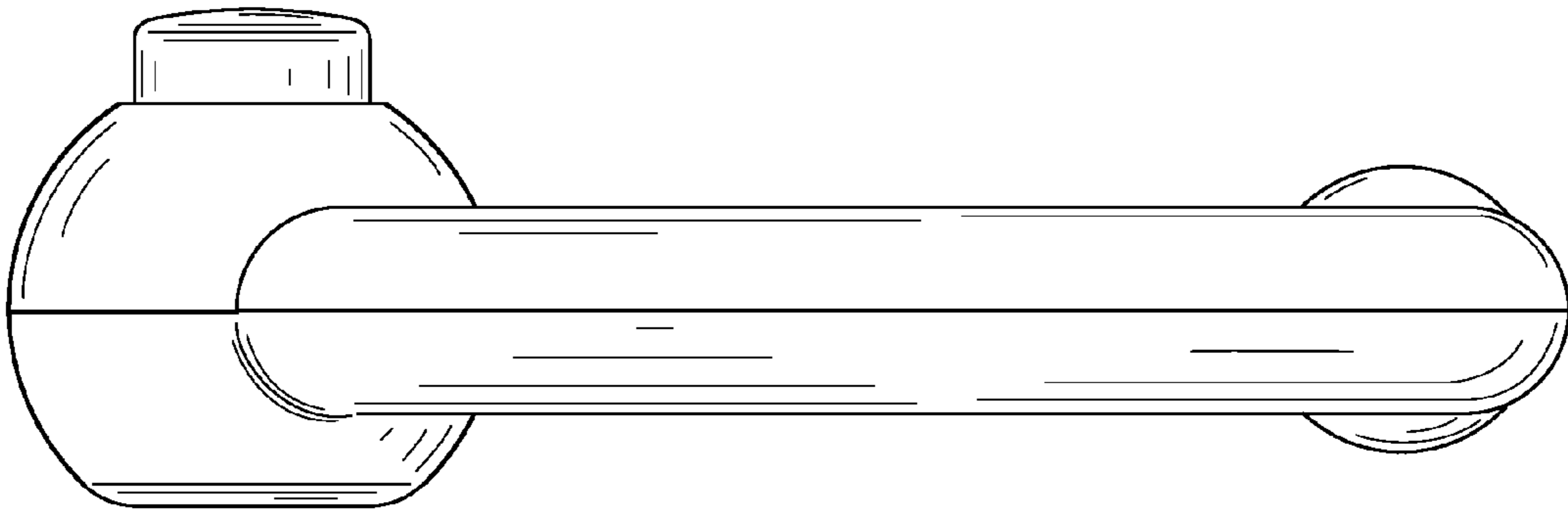

FIG. 4

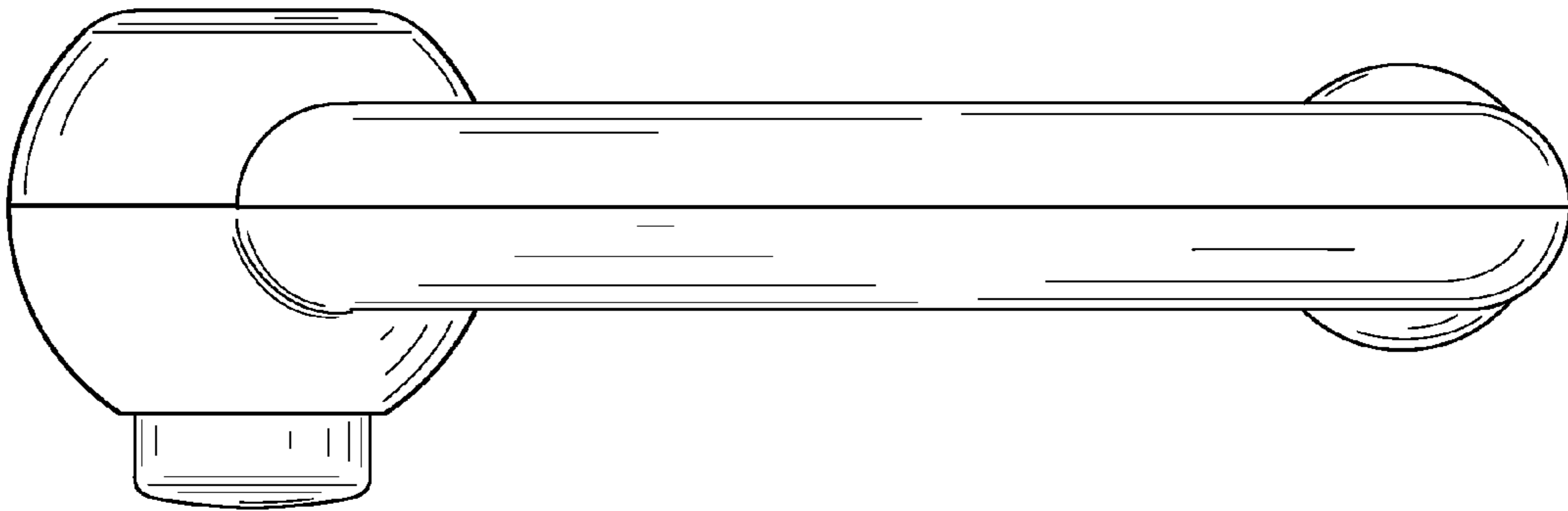

FIG. 5

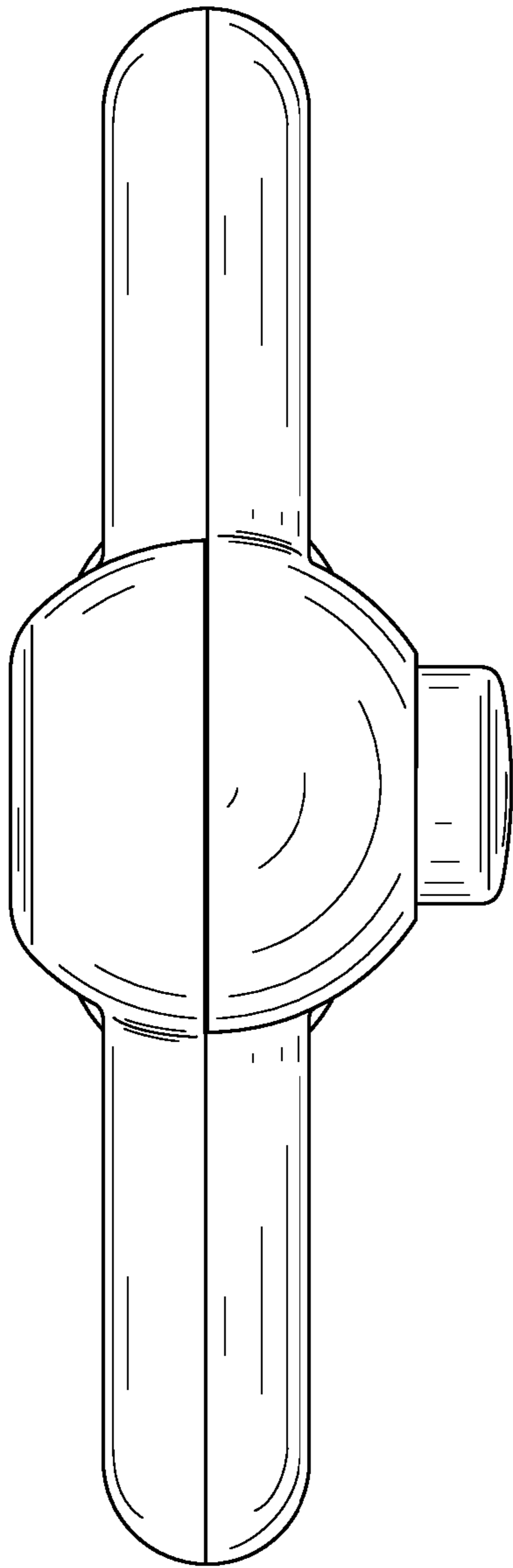

FIG. 6

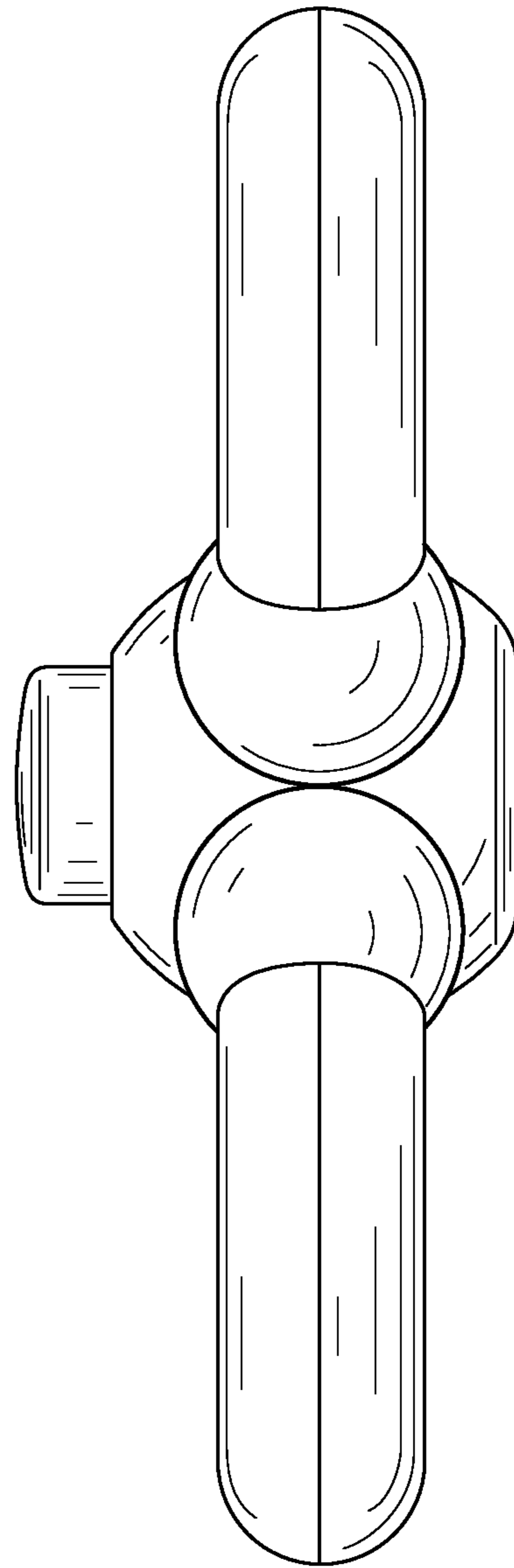

FIG. 7

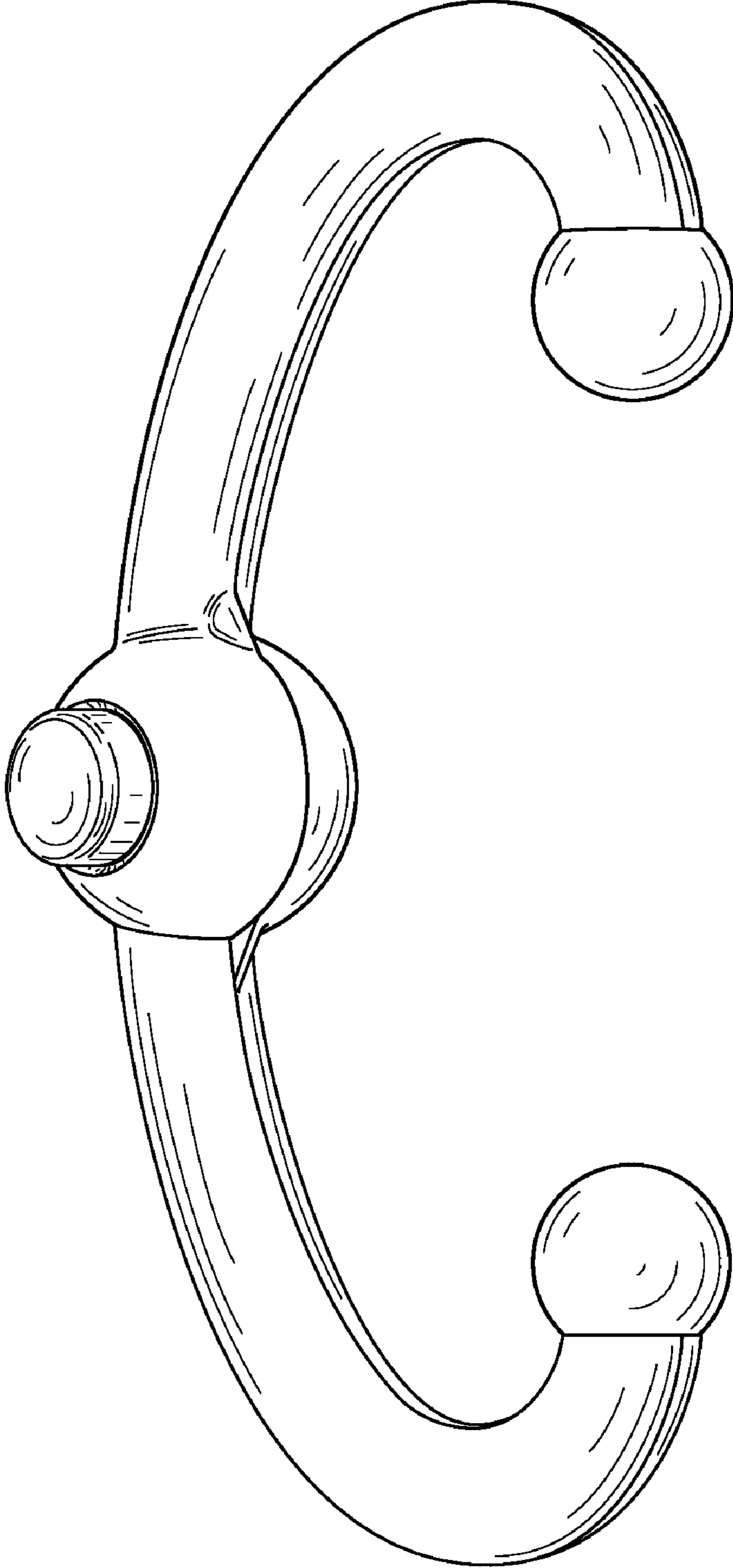

FIG. 8

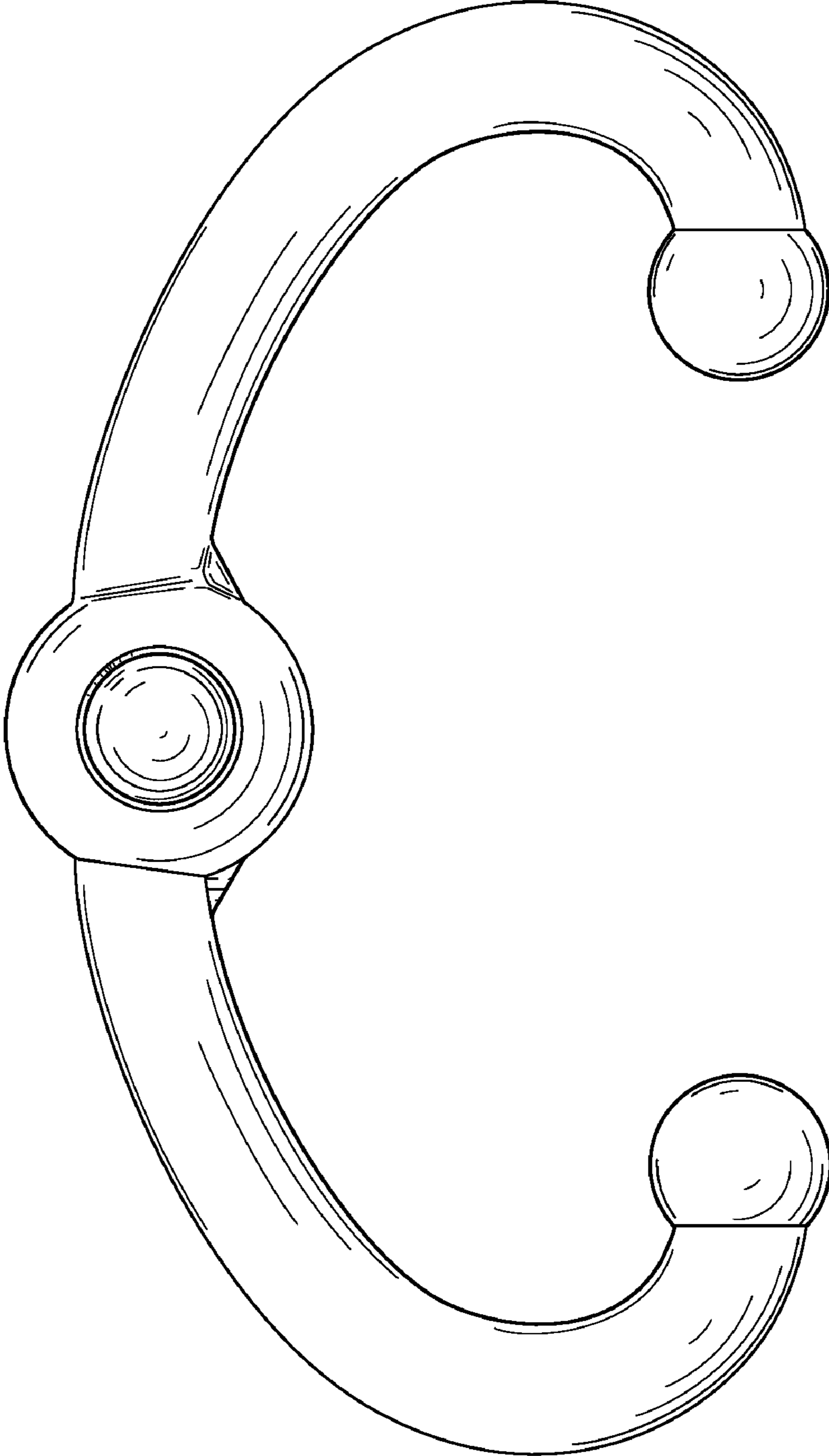

FIG. 9

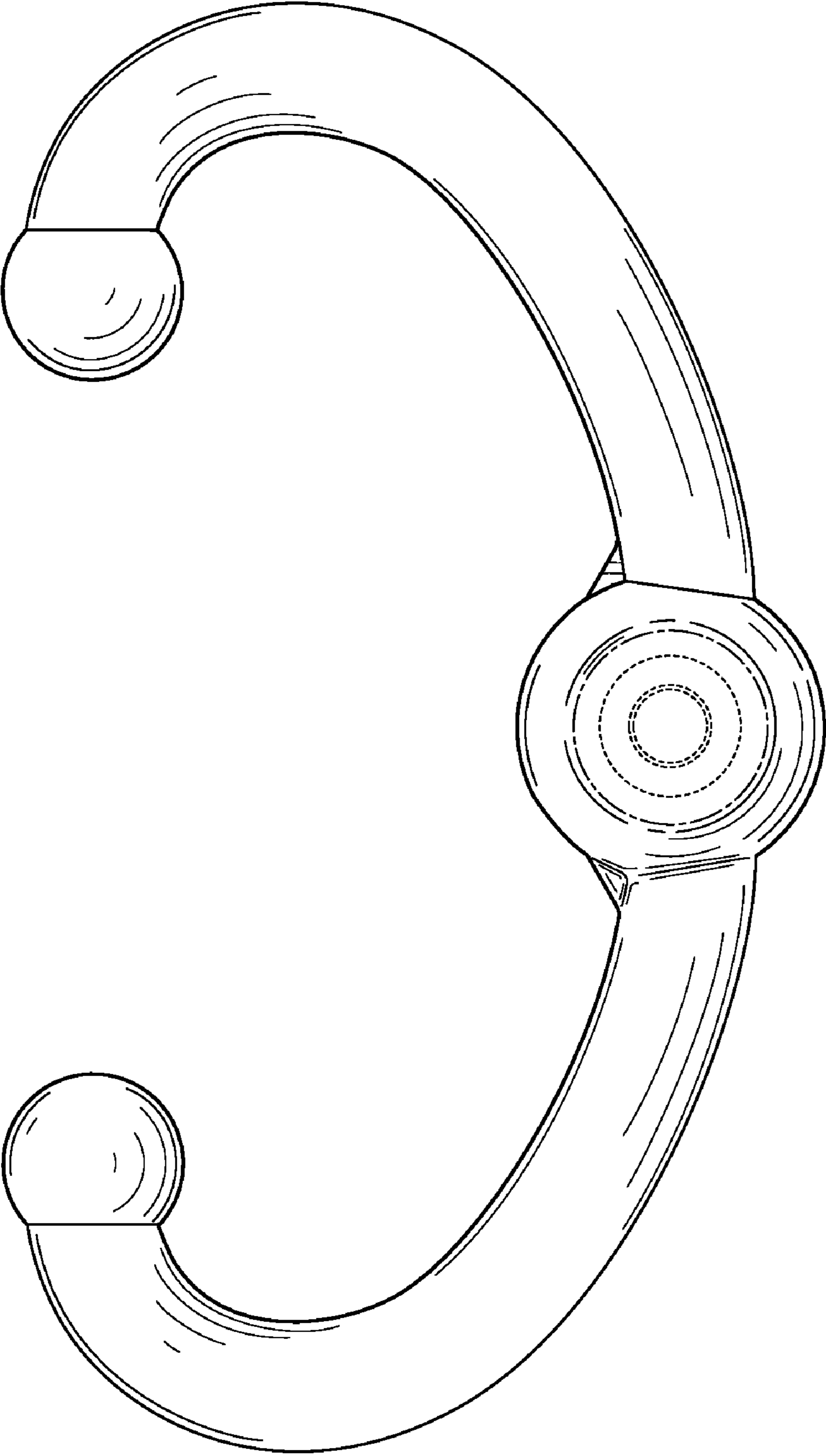

FIG. 10

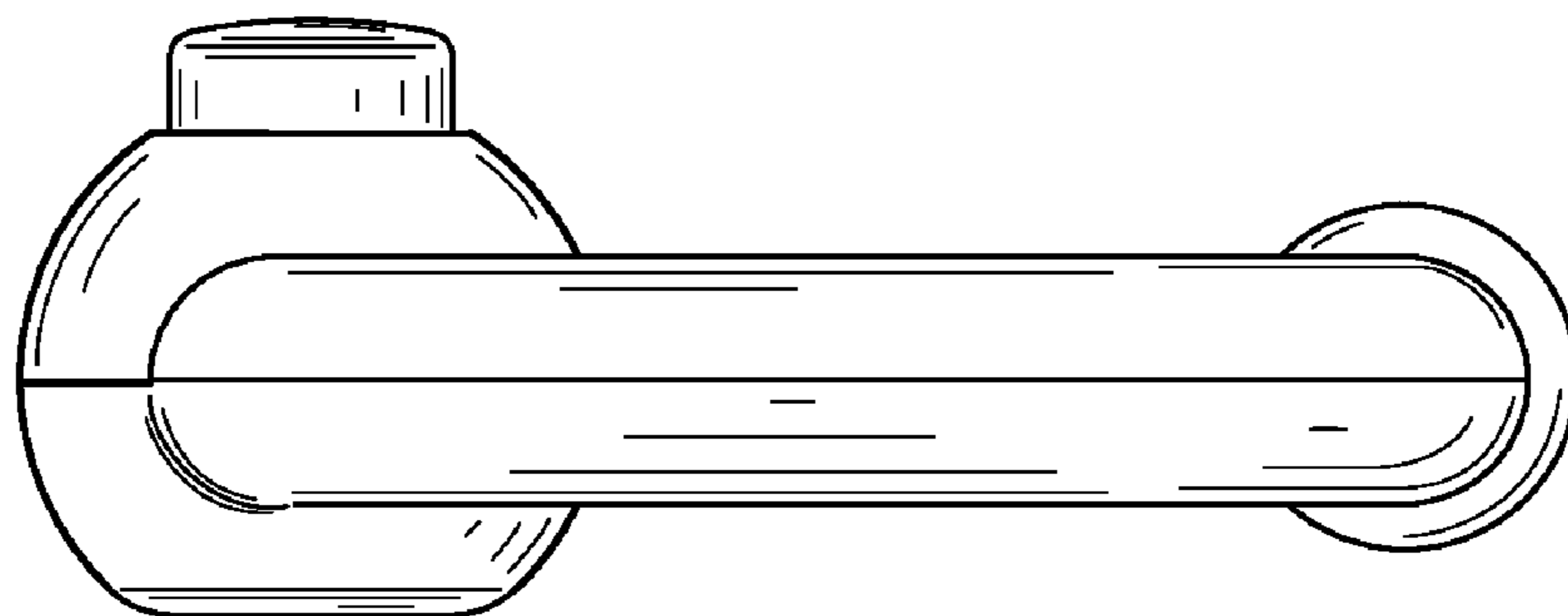

FIG. 11

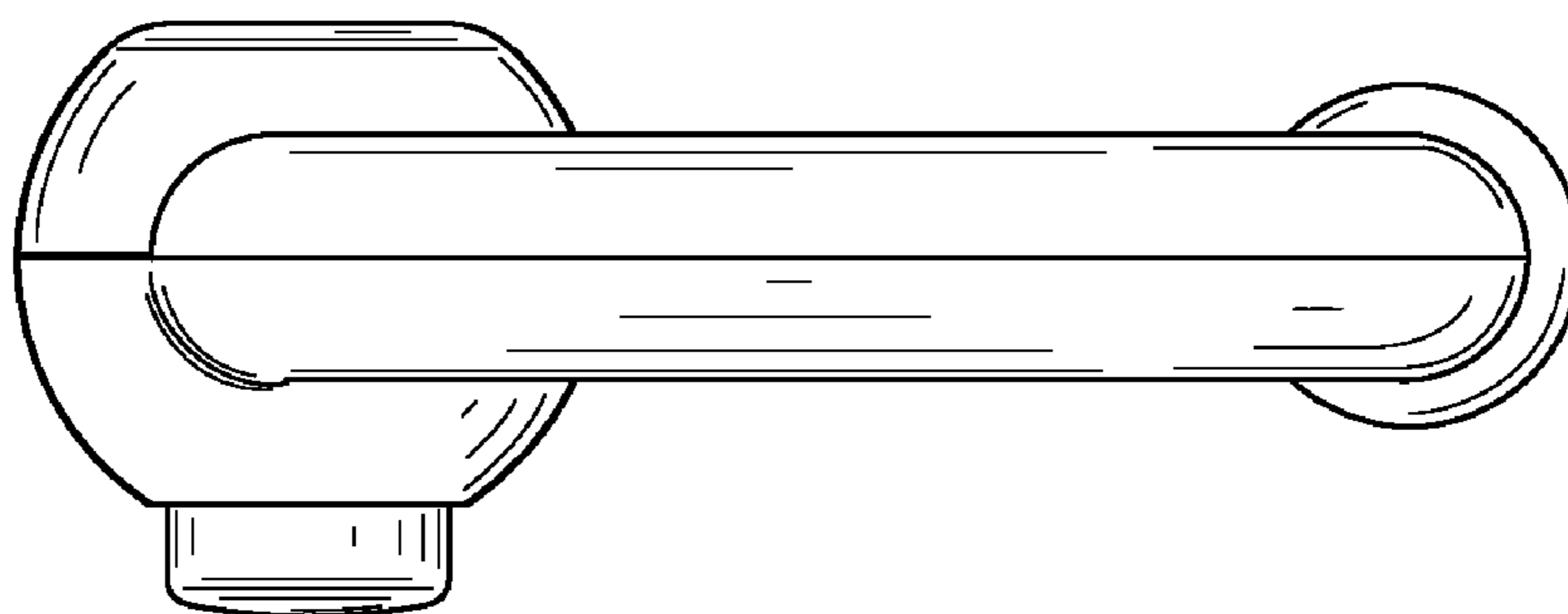

FIG. 12

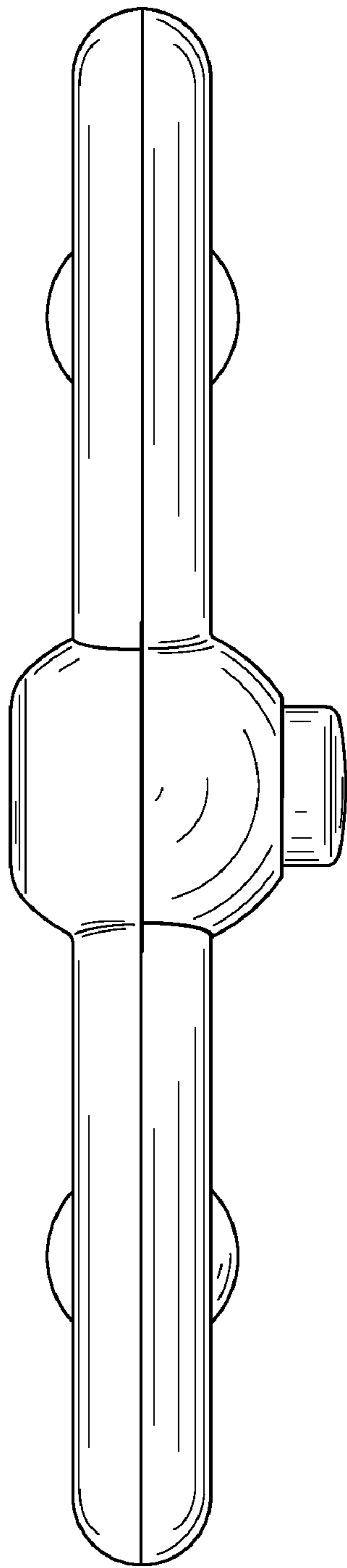

FIG. 13

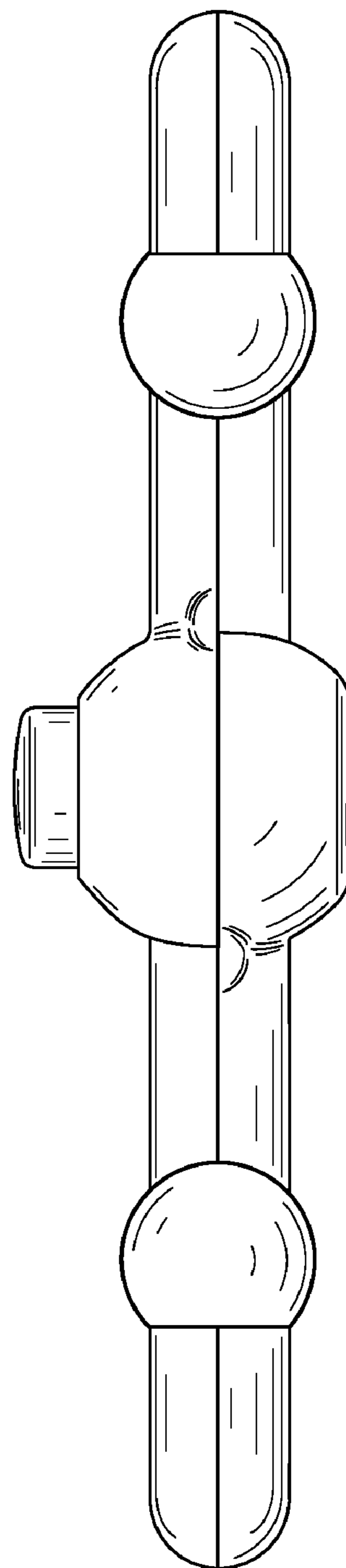

FIG. 14