

US00D642438S

(12) **United States Design Patent**  
**Schofield et al.**

(10) **Patent No.:** **US D642,438 S**

(45) **Date of Patent:** **\*\* Aug. 2, 2011**

(54) **DRINKING CUP**

(75) Inventors: **Paul Schofield**, Middlesborough (GB);  
**Ian Webb**, London (GB); **Mark**  
**Armstrong**, Wales (GB); **Tom Cotton**,  
London (GB)

(73) Assignee: **Jackel International Limited**,  
Cramlington, Northumberland (GB)

(\*\*) Term: **14 Years**

(21) Appl. No.: **29/349,533**

(22) Filed: **Apr. 12, 2010**

(30) **Foreign Application Priority Data**

Oct. 12, 2009 (EM) ..... 0001171391-0011  
Oct. 12, 2009 (EM) ..... 0001171391-0012  
Oct. 12, 2009 (EM) ..... 0001171391-0013

(51) **LOC (9) Cl.** ..... **07-01**

(52) **U.S. Cl.** ..... **D7/510; D7/511; D24/197**

(58) **Field of Classification Search** ..... D7/510,  
D7/511, 534, 509; 215/11.1; 220/714; D24/197  
See application file for complete search history.

(56) **References Cited**

**U.S. PATENT DOCUMENTS**

D356,160 S \* 3/1995 Cautereels ..... D24/197  
D460,322 S \* 7/2002 Orr et al. .... D7/510  
D469,322 S \* 1/2003 Jørgensen ..... D7/653  
6,568,557 B2 \* 5/2003 Fusco et al. .... 220/714  
D501,361 S \* 2/2005 Tollman ..... D7/510  
D511,385 S \* 11/2005 Lieberman et al. .... D24/197  
D538,938 S \* 3/2007 Pillado ..... D24/197  
D545,623 S \* 7/2007 Renz et al. .... D7/510  
7,562,789 B2 \* 7/2009 Randolph et al. .... 220/710.5  
D609,527 S \* 2/2010 Roehrig et al. .... D7/510  
D617,465 S \* 6/2010 Hakim ..... D24/197

D619,851 S \* 7/2010 Miller et al. .... D7/510  
D620,309 S \* 7/2010 Boonprasop ..... D7/396.2  
D620,315 S \* 7/2010 Boonprasop ..... D7/509

\* cited by examiner

*Primary Examiner* — Marianne Pandozzi

(74) *Attorney, Agent, or Firm* — Olson & Cepuritis, Ltd.

(57) **CLAIM**

The ornamental design for a drinking cup, as shown and described.

**DESCRIPTION**

FIG. 1 is a perspective view of a drinking cup showing our new design with the spout in open position;  
FIG. 2 is a side elevational view thereof, with the spout in closed position;  
FIG. 3 is an opposite side elevational view of FIG. 2;  
FIG. 4 is a front elevational view of FIG. 2;  
FIG. 5 is a rear elevational view of FIG. 2;  
FIG. 6 is a top plan view of FIG. 2;  
FIG. 7 is a bottom plan view thereof;  
FIG. 8 is a perspective view of a drinking cup showing our new design with the lid removed for ease of illustration;  
FIG. 9 is a rear elevational view of FIG. 8;  
FIG. 10 is a front elevational view of FIG. 8;  
FIG. 11 is a top plan view of FIG. 8;  
FIG. 12 is a bottom plan view of FIG. 8;  
FIG. 13 is a side elevational view of FIG. 8;  
FIG. 14 is a perspective view of a drinking cup showing our new design with the base removed for ease of illustration and the spout in closed position;  
FIG. 15 is a front elevational view of FIG. 14;  
FIG. 16 is a rear elevational view of FIG. 14;  
FIG. 17 is a top plan view of FIG. 14;  
FIG. 18 is a bottom plan view of FIG. 14; and,  
FIG. 19 is a side elevational view of FIG. 14.

**1 Claim, 12 Drawing Sheets**

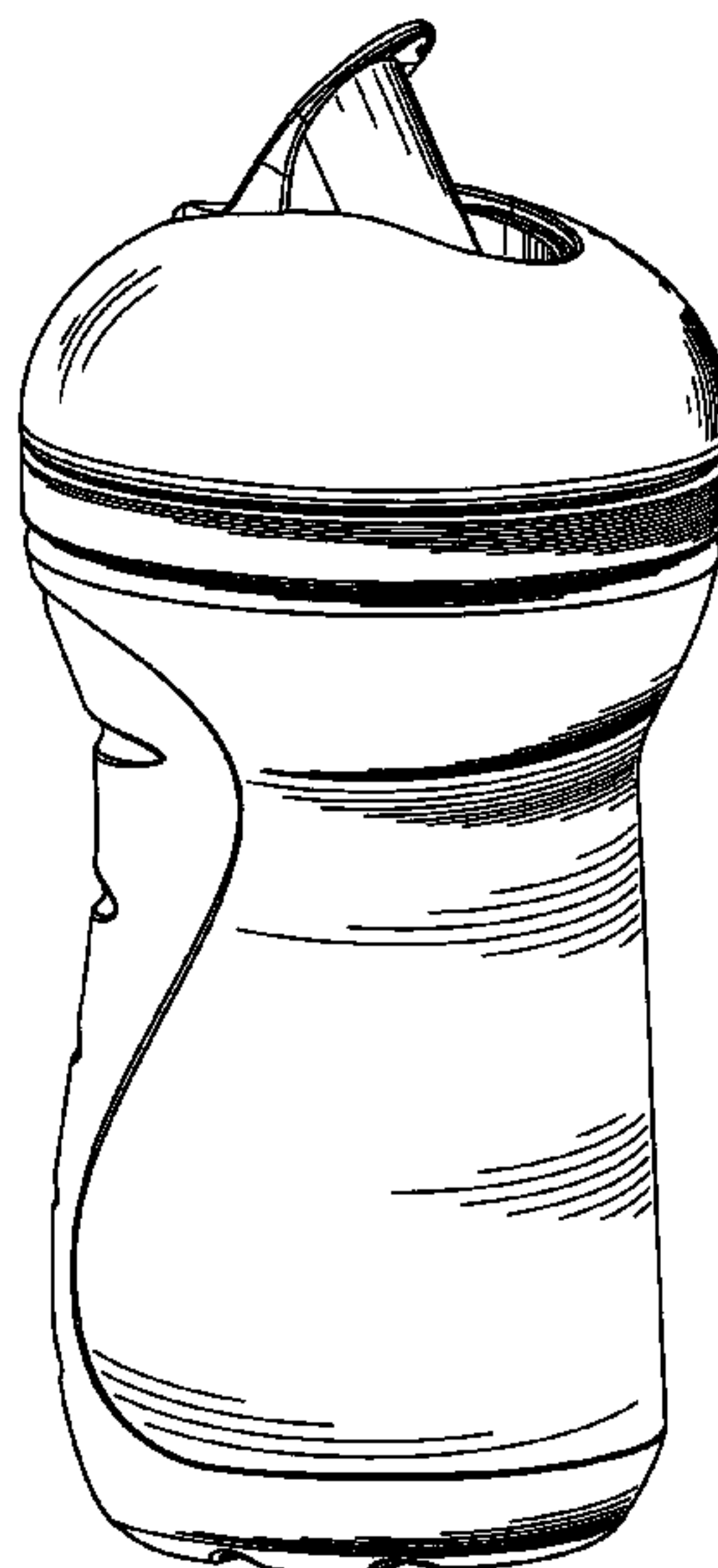

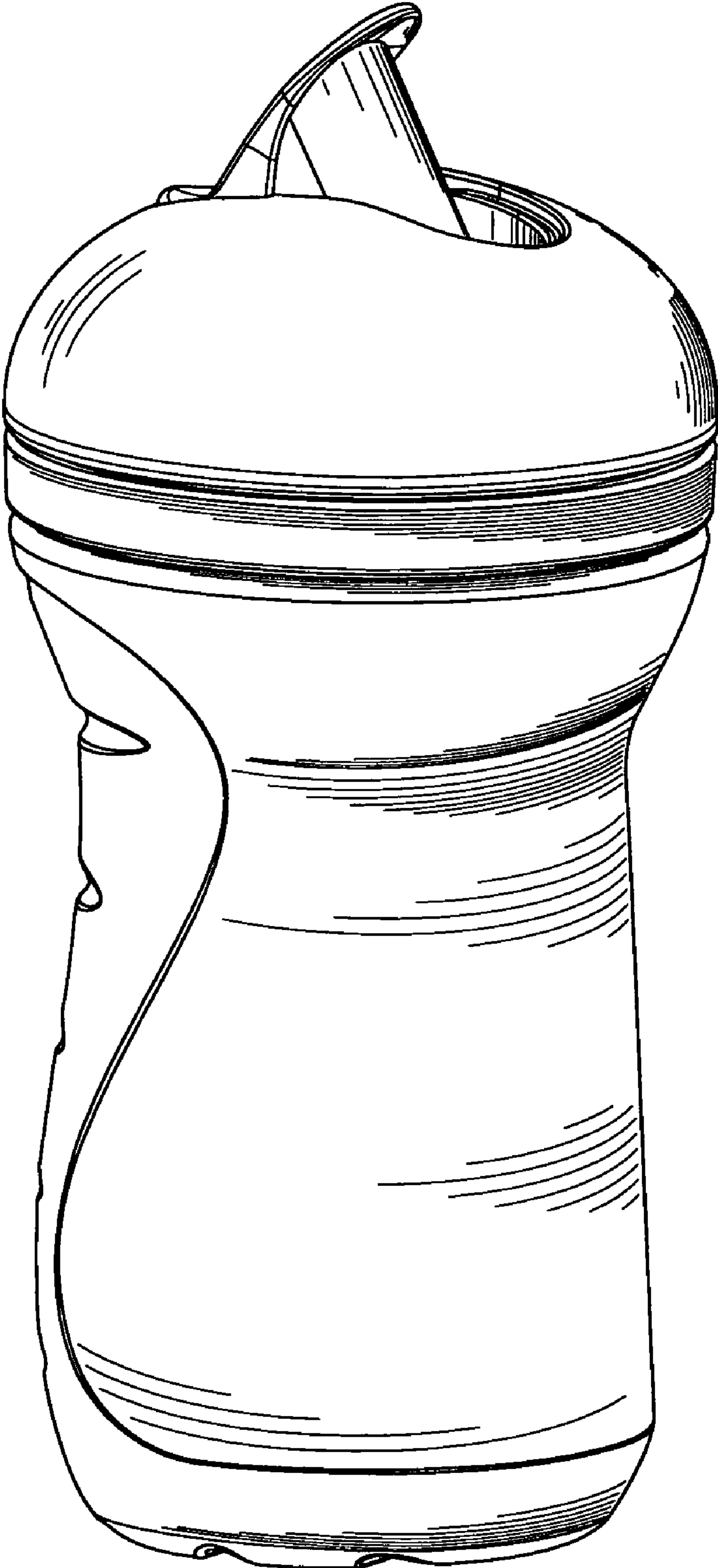

**FIG. 1**

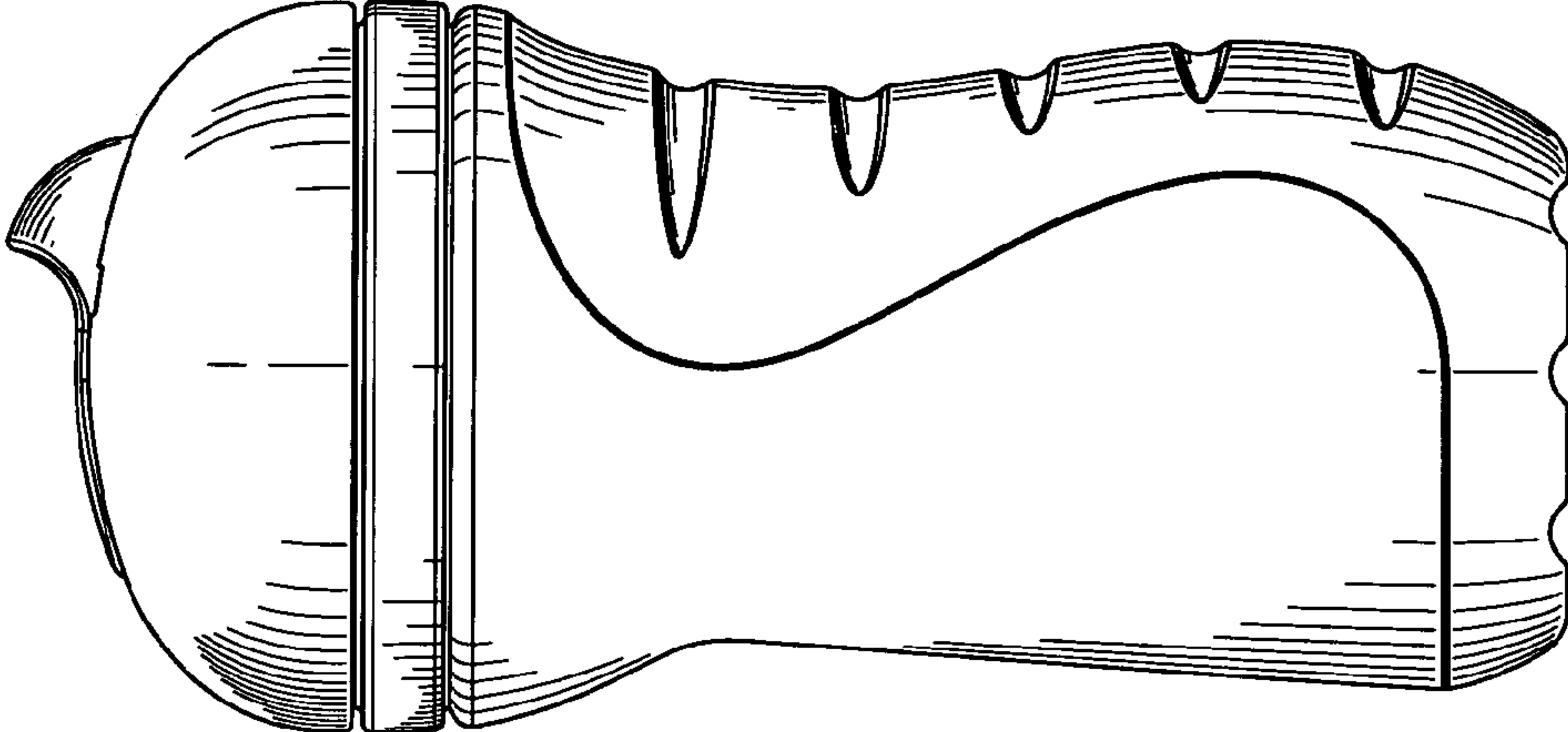

FIG. 3

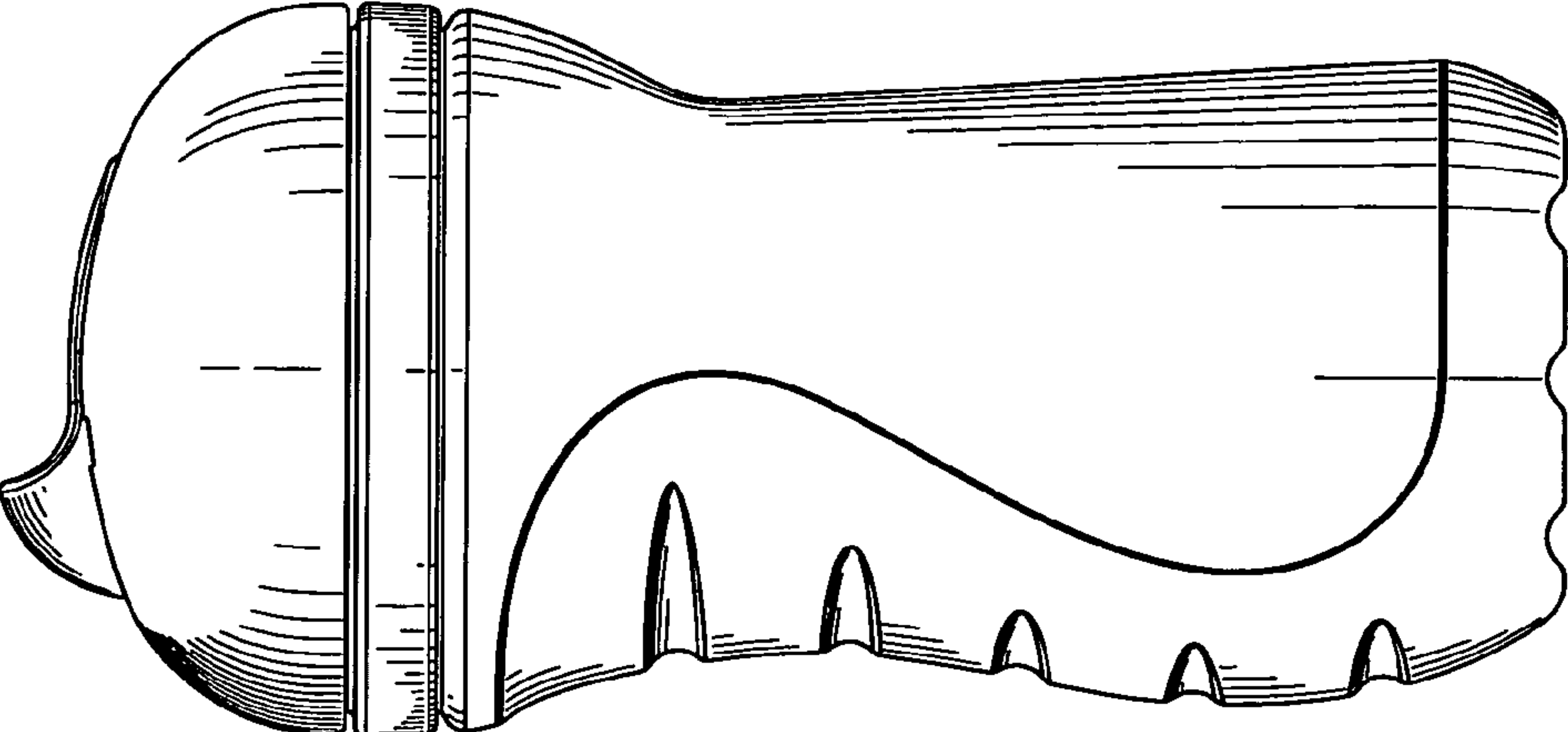

FIG. 2

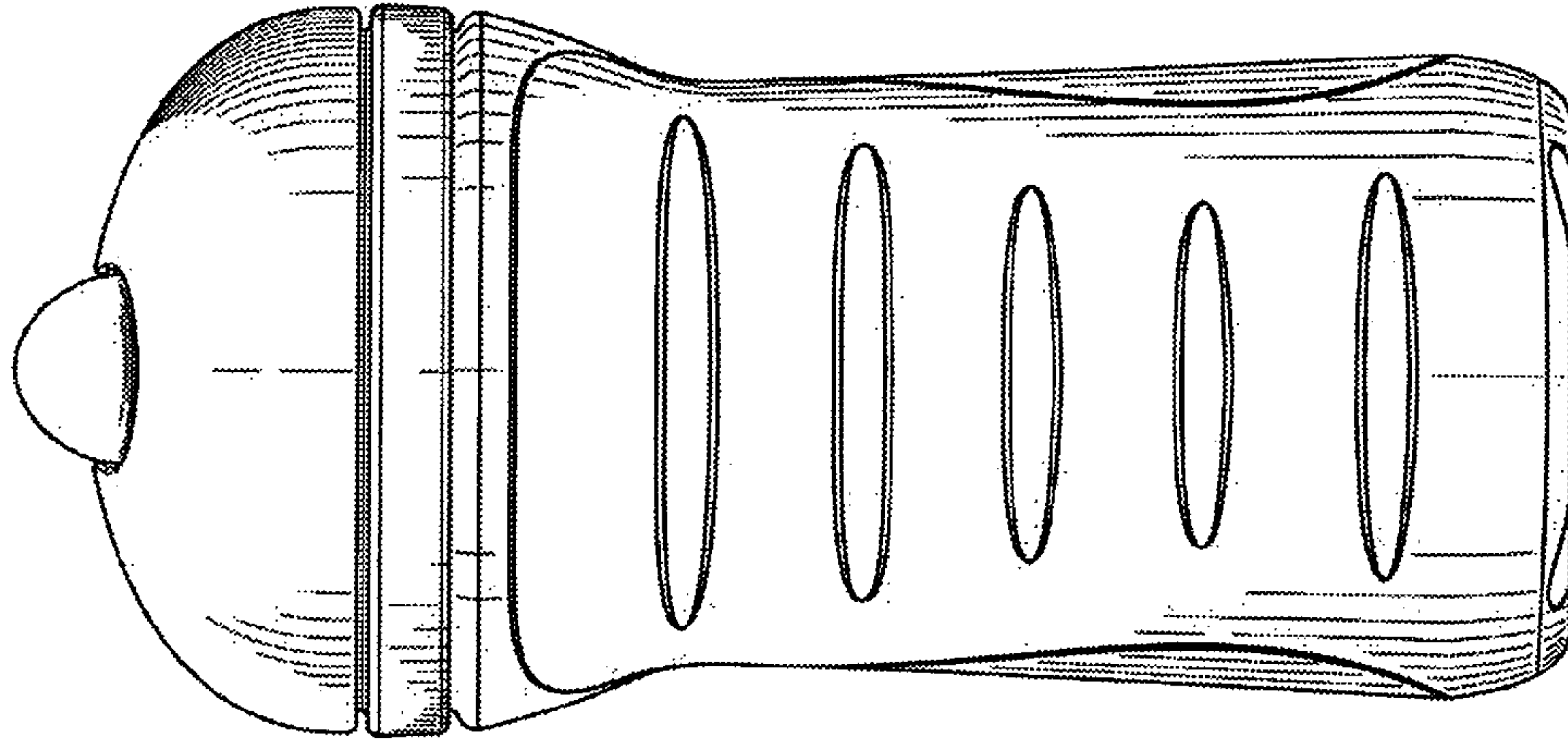

FIG. 5

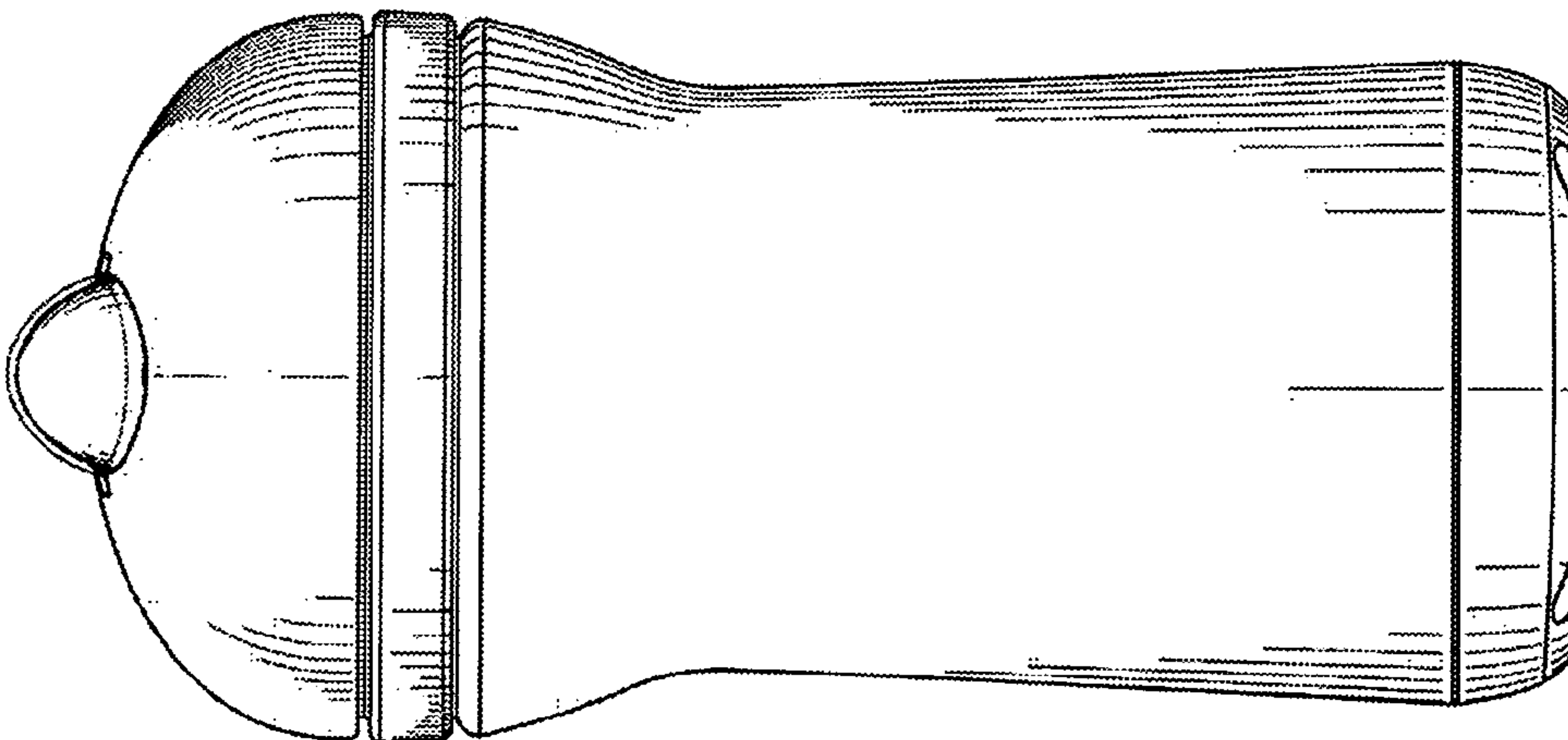
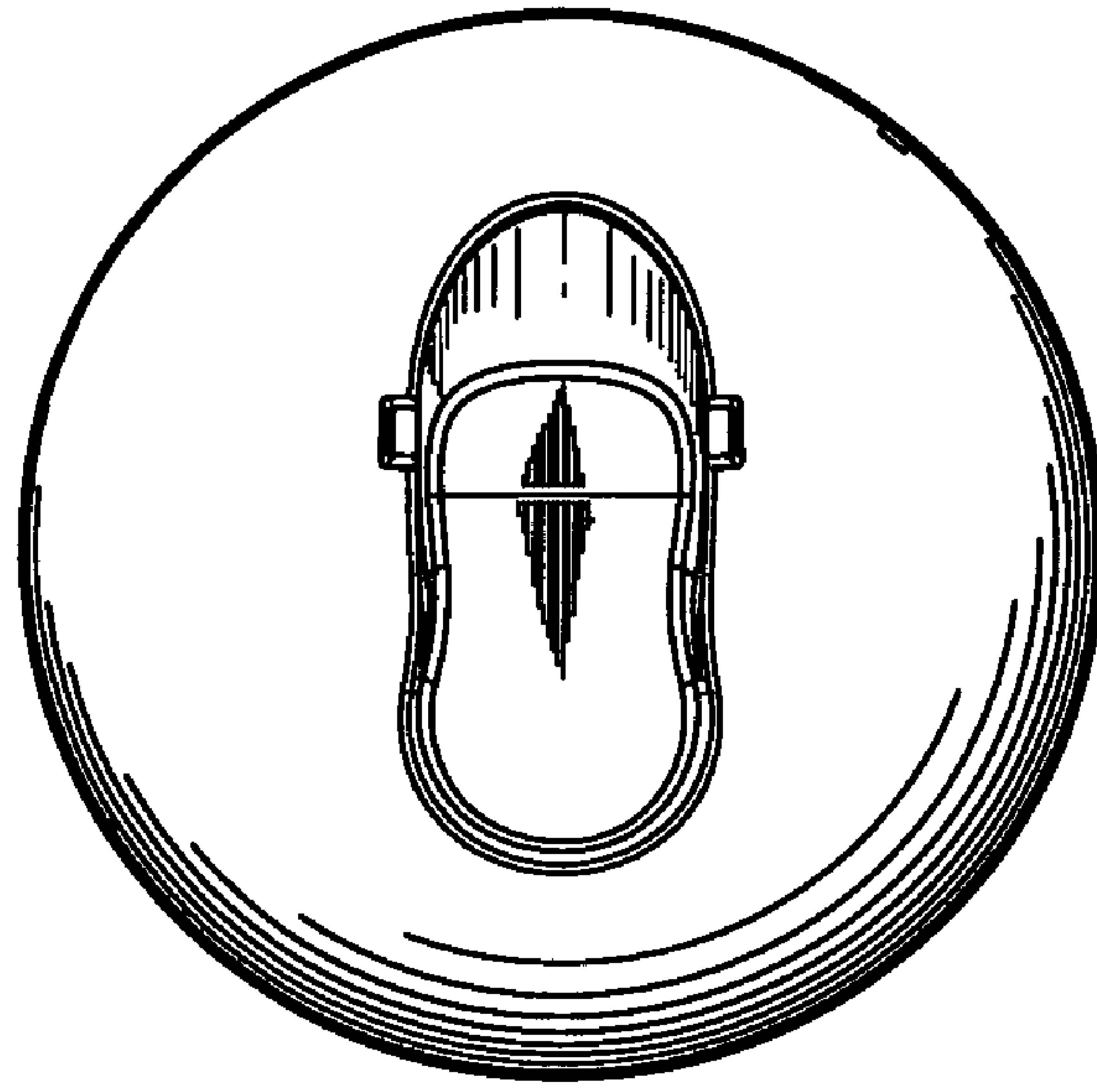
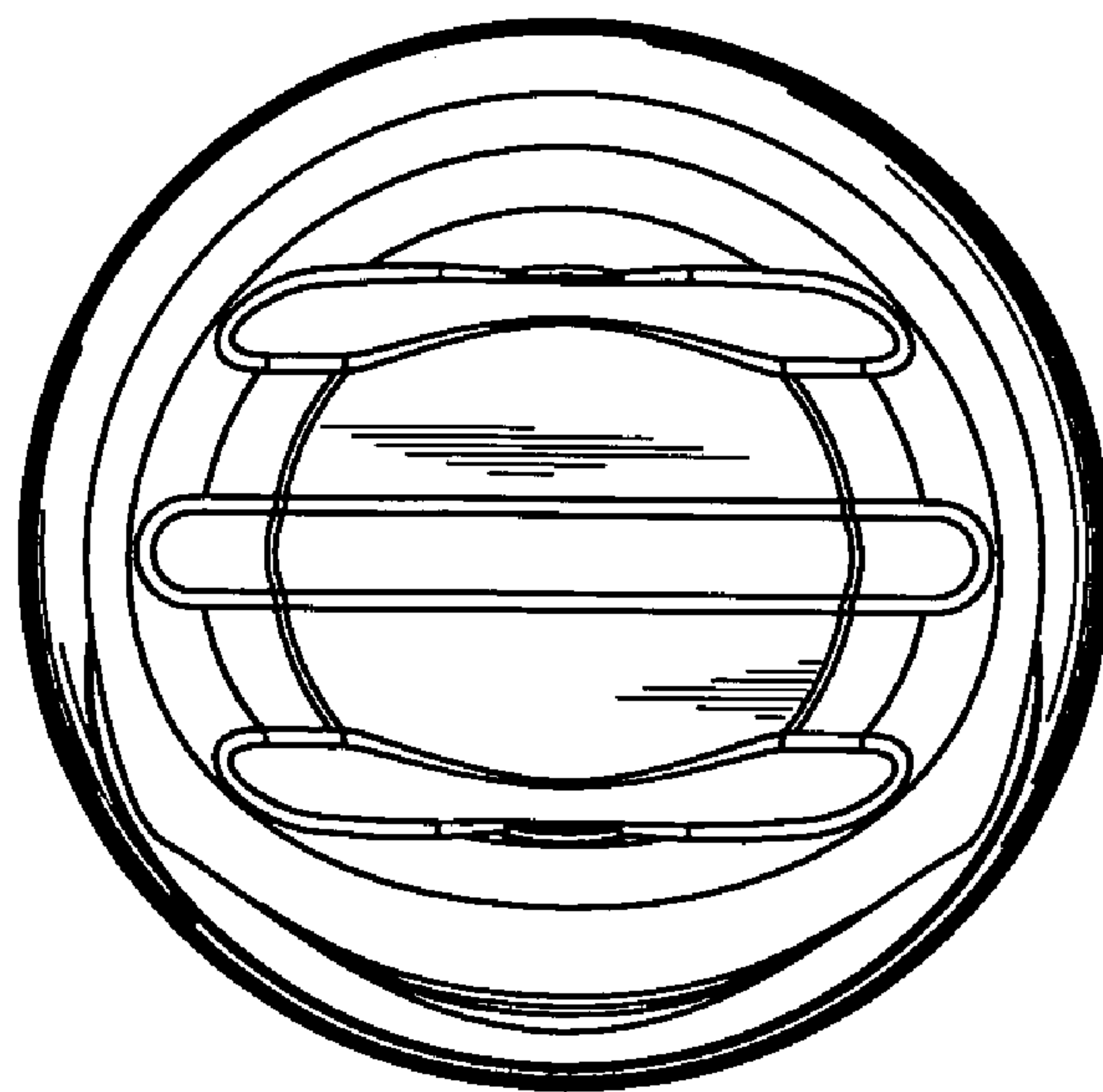

FIG. 4

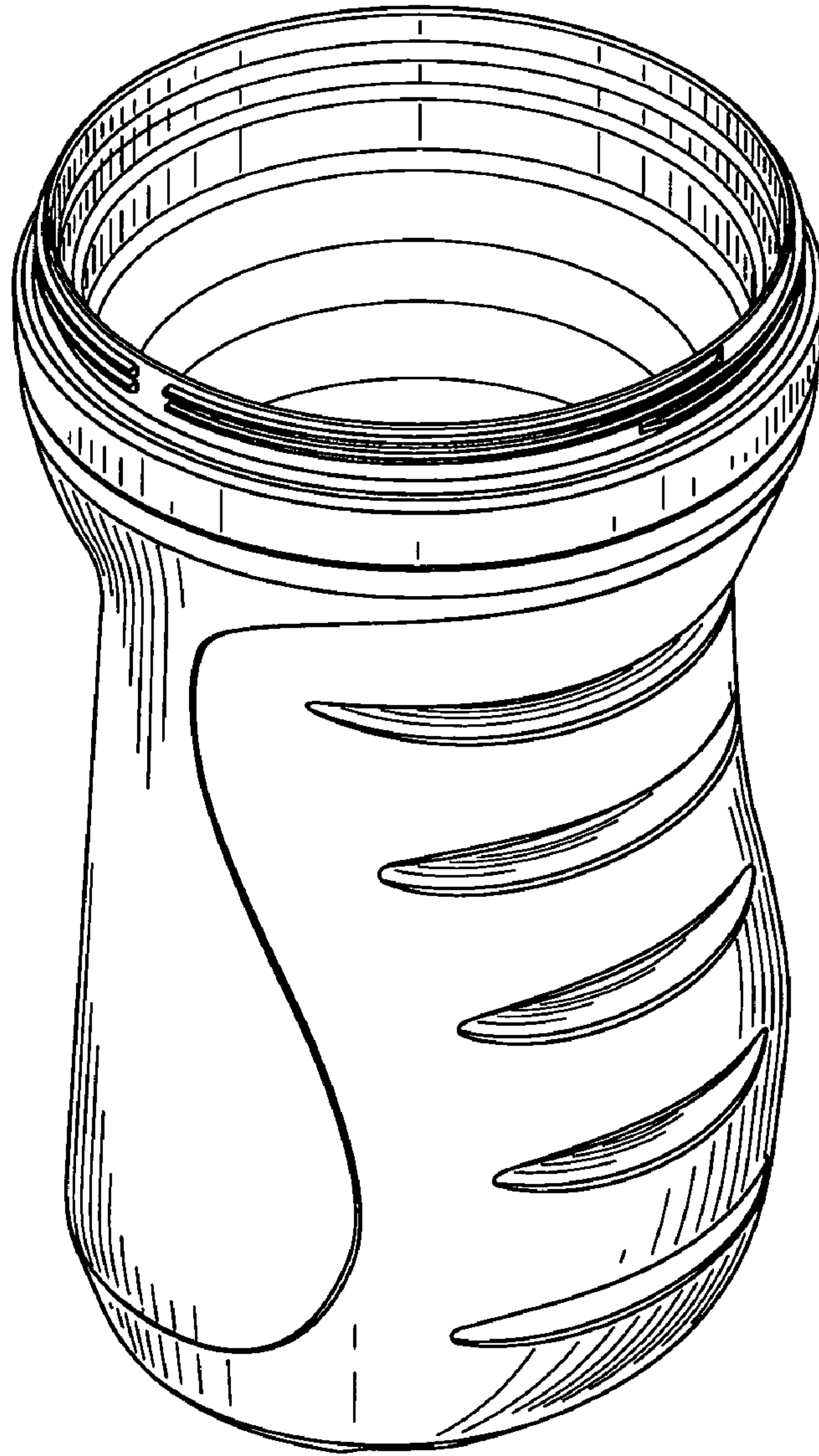



**FIG. 6**



**FIG. 7**



**FIG. 8**

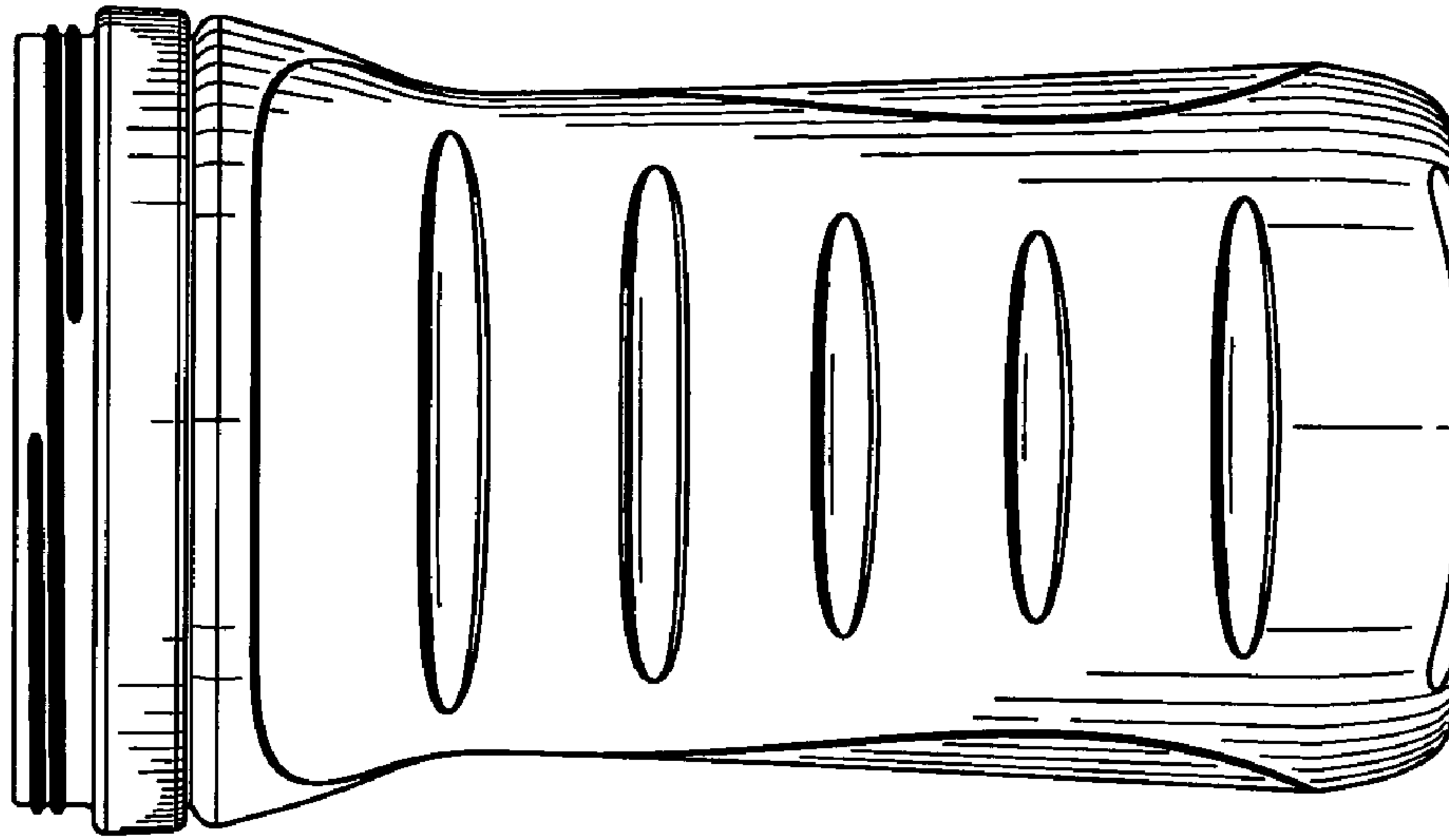

FIG. 10

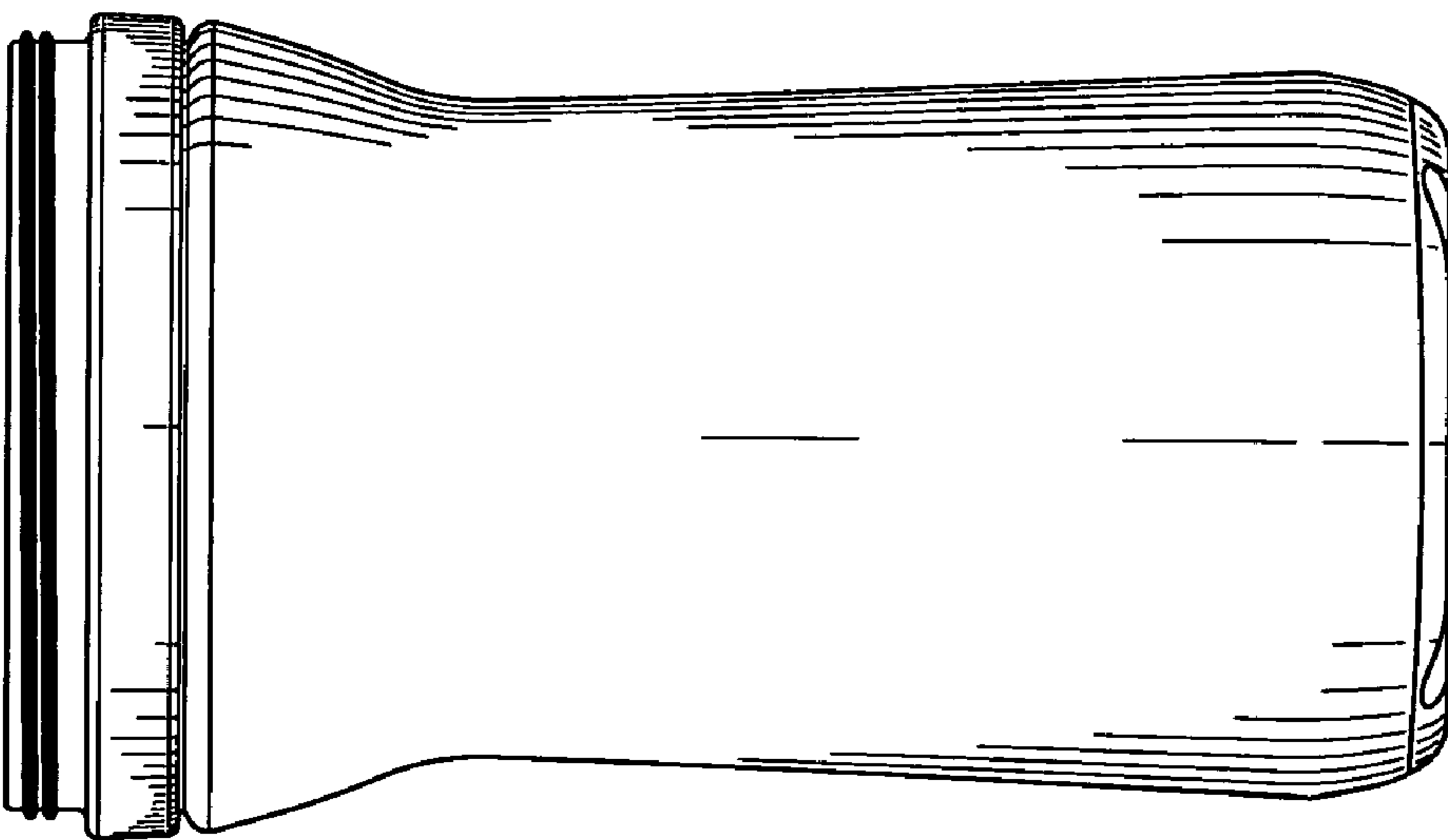
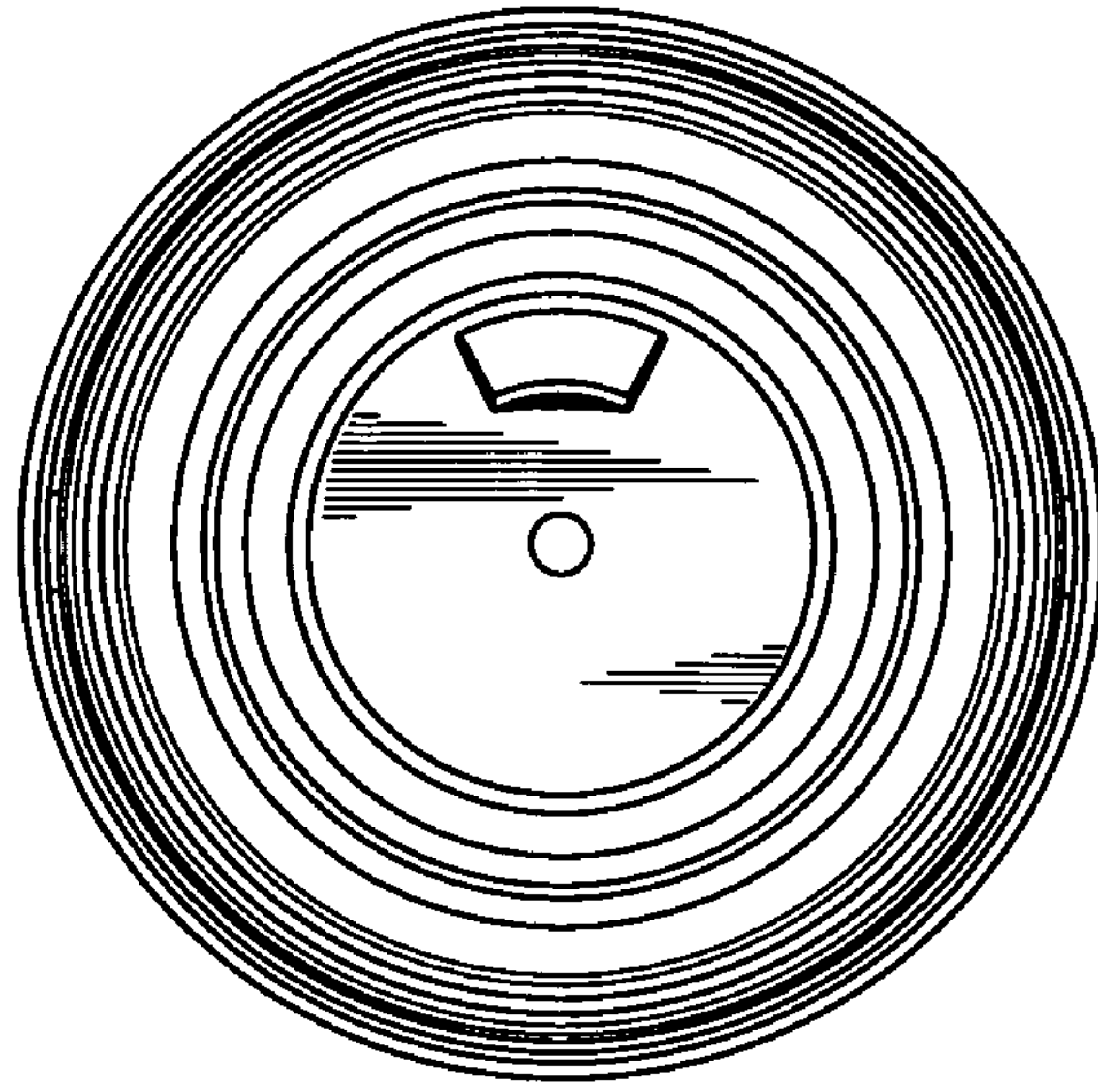
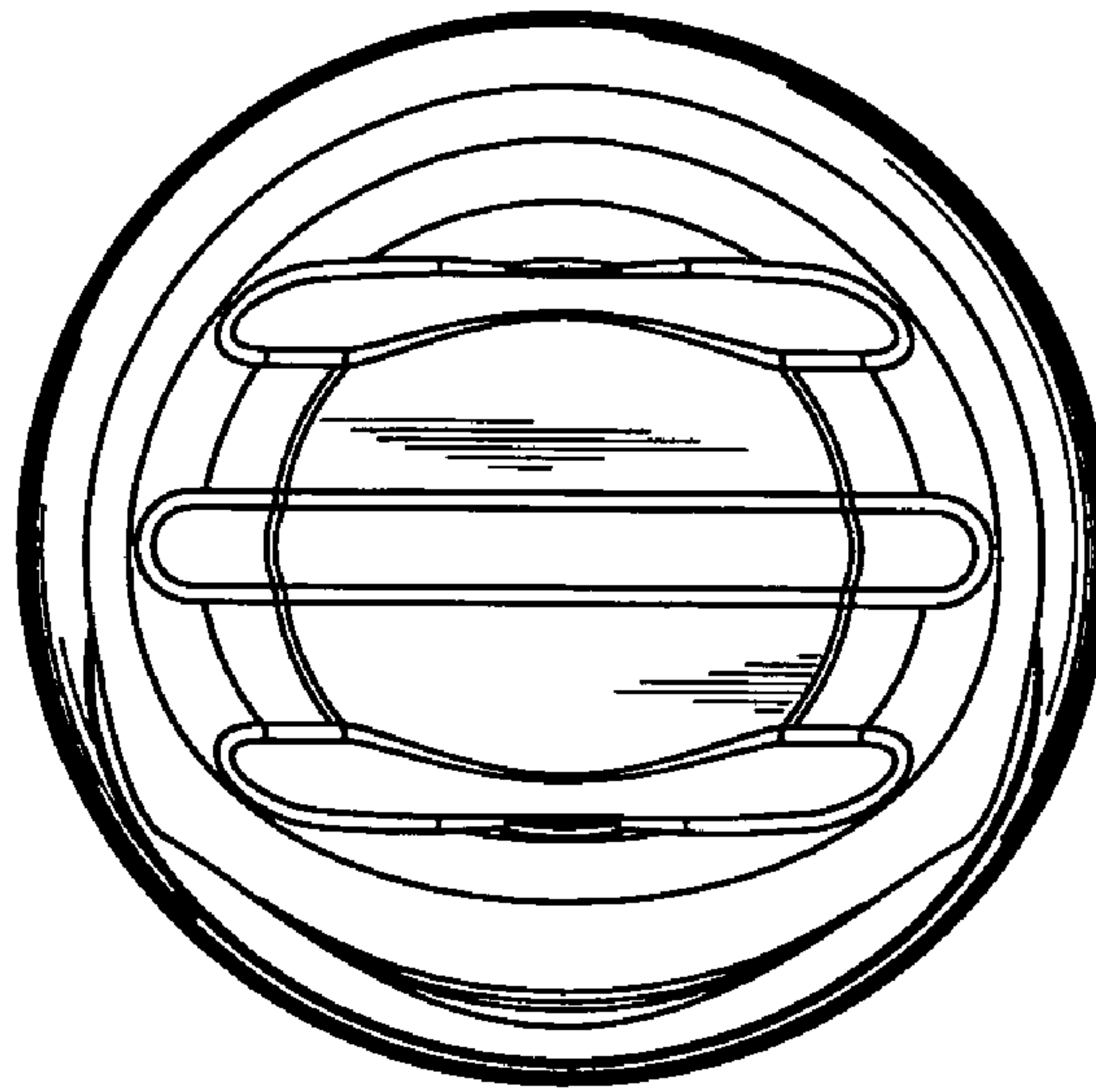

FIG. 9

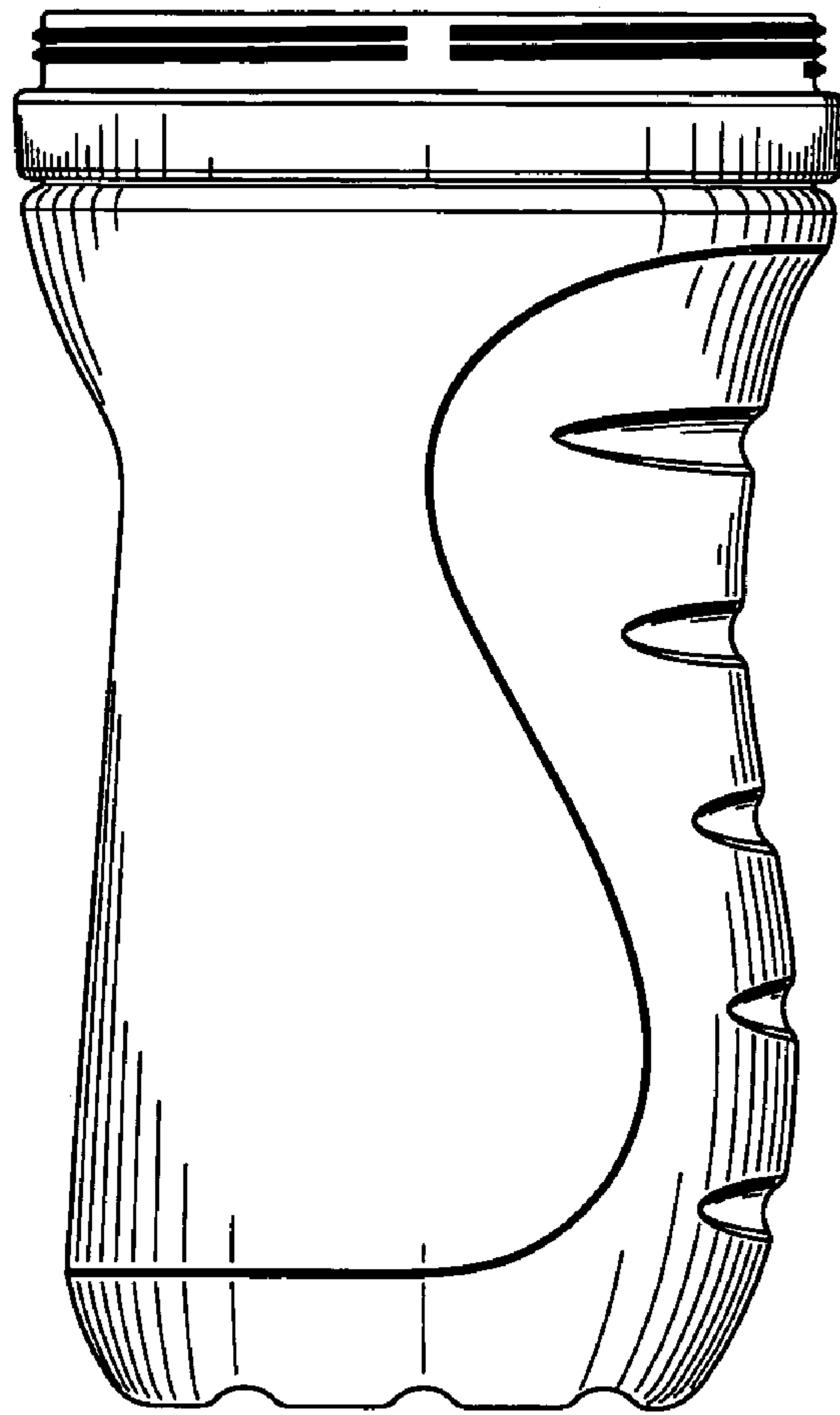

**FIG. 11**

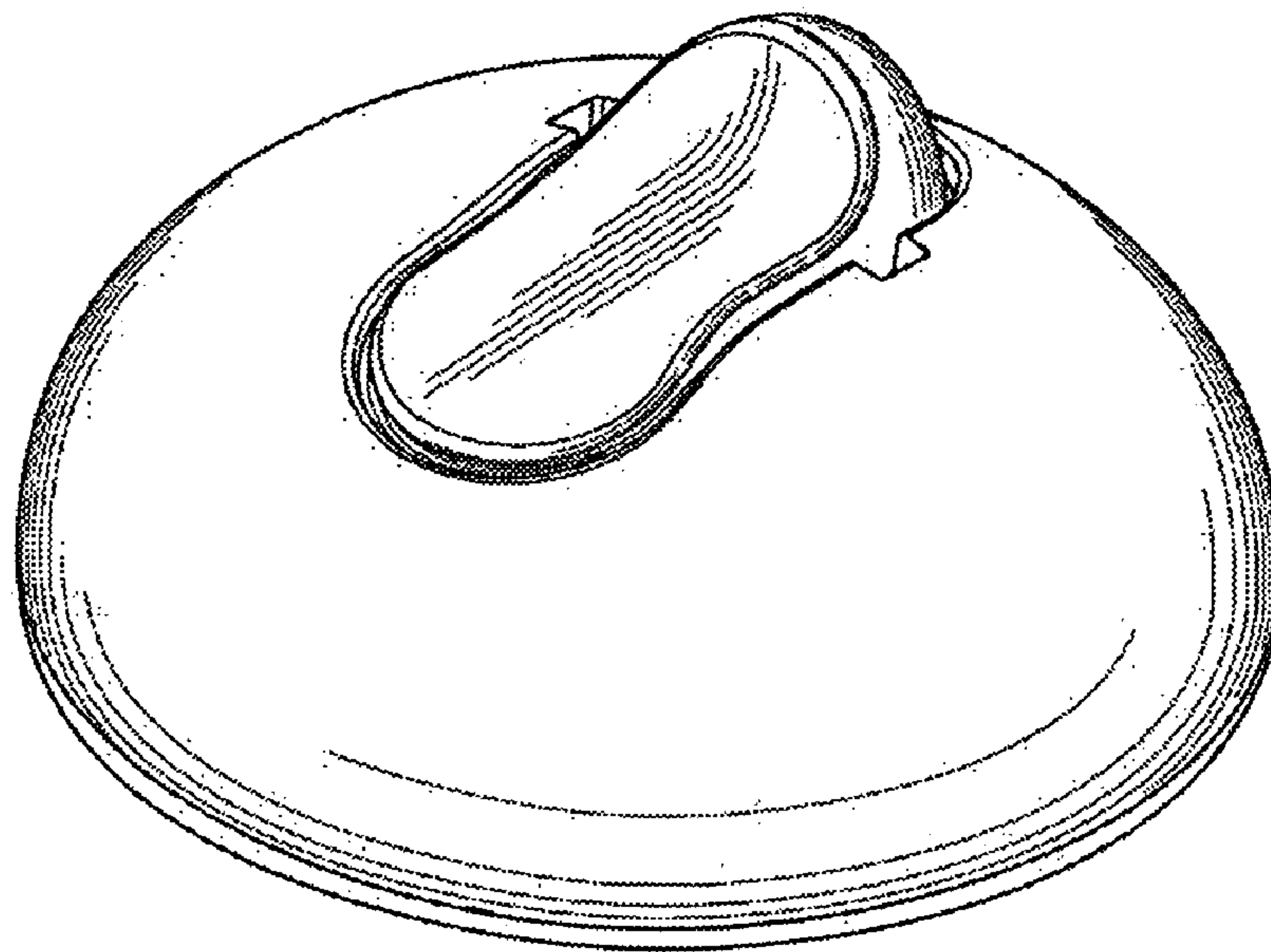

**FIG. 12**

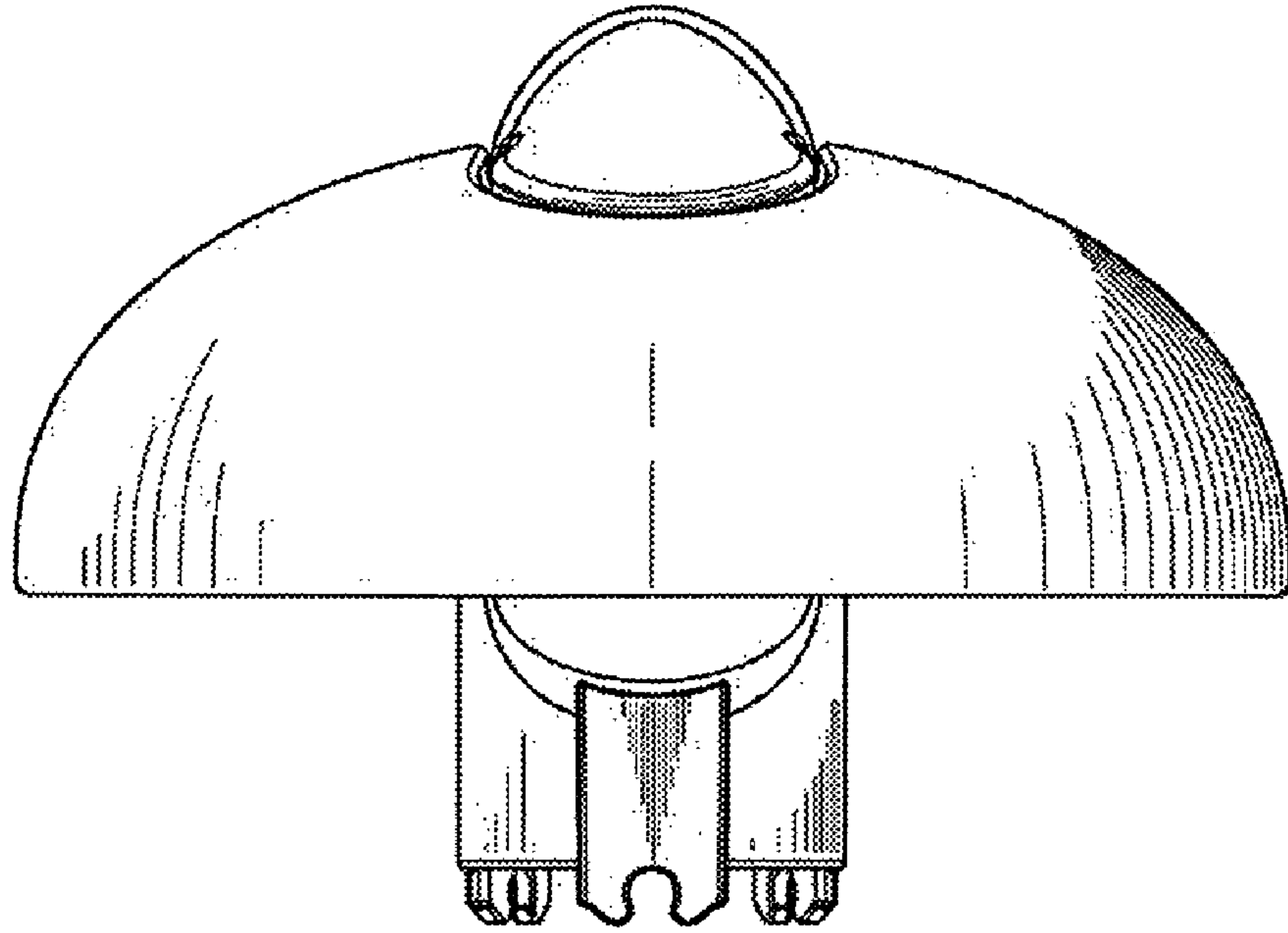



*FIG. 13*



**FIG. 14**



**FIG. 15**

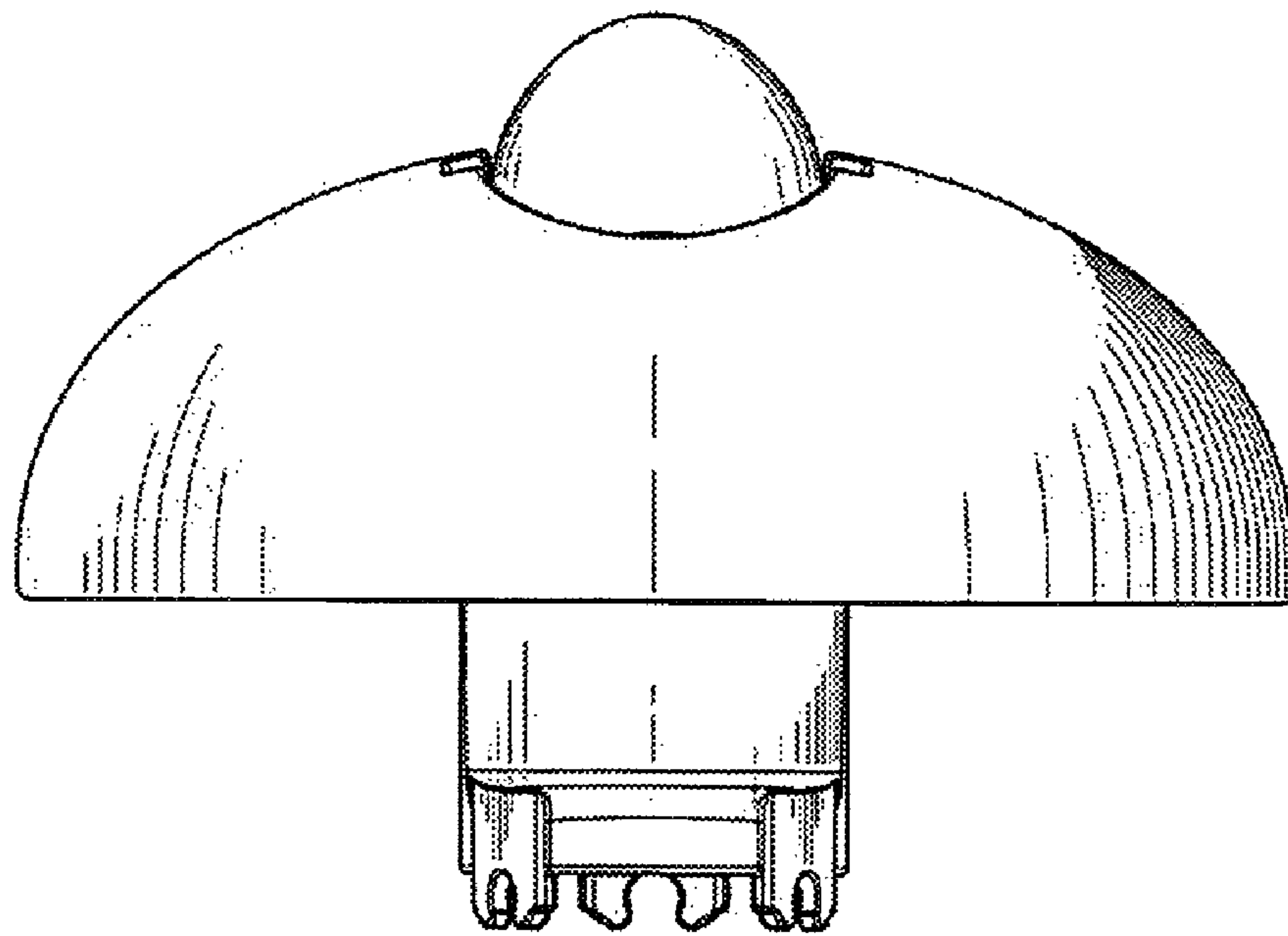

**FIG. 16**

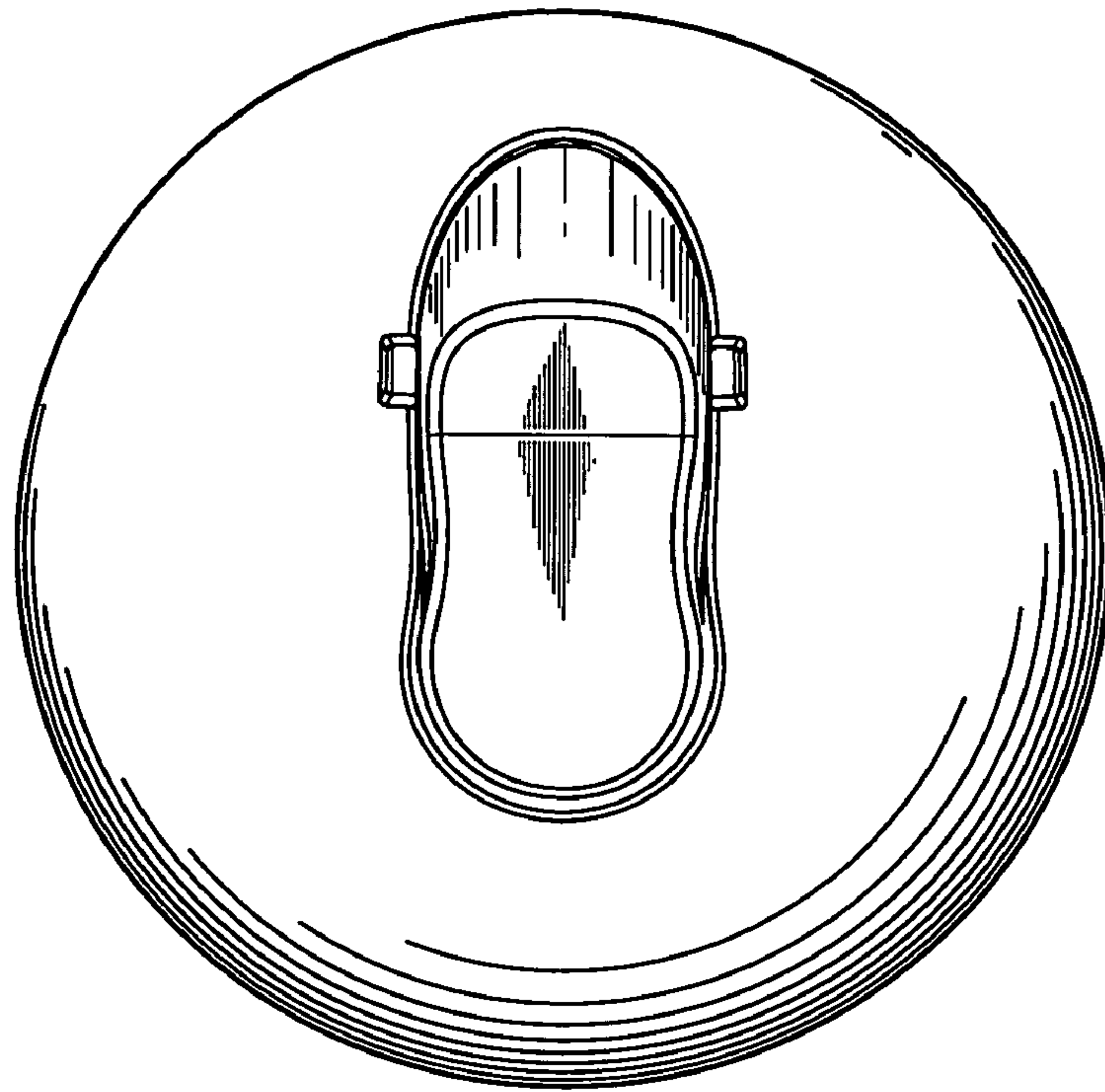

*FIG. 17*

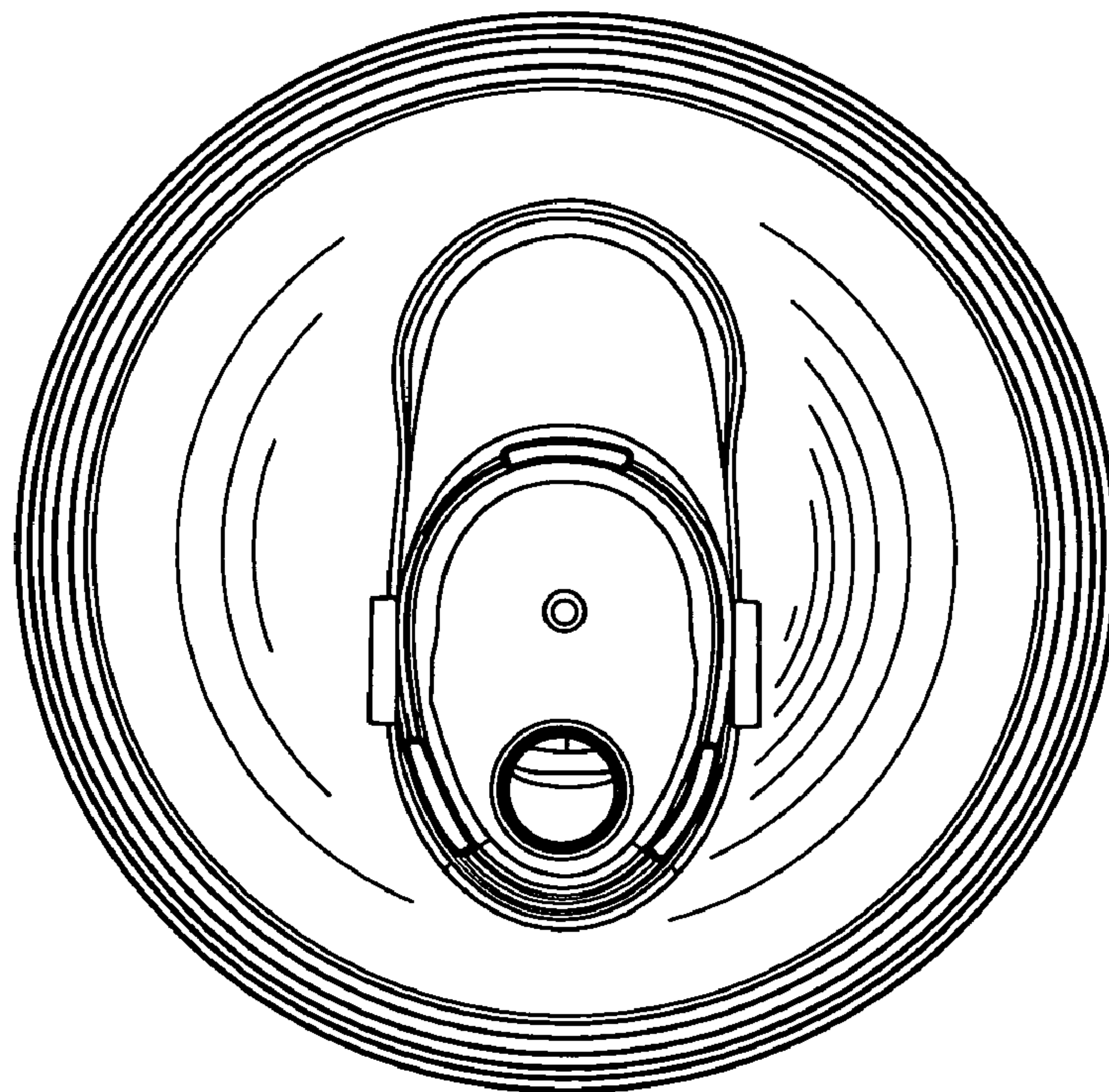

*FIG. 18*

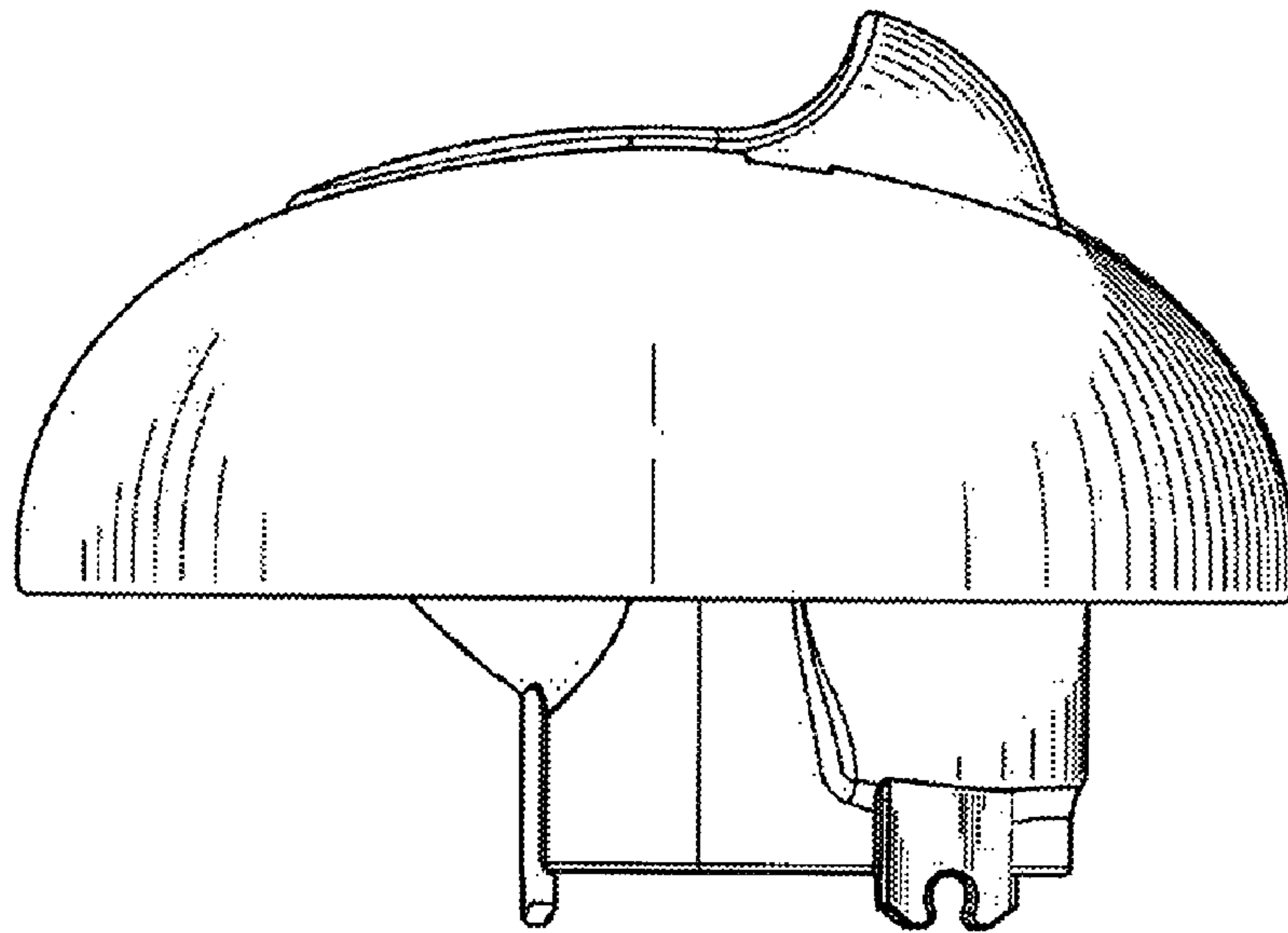

**FIG. 19**