



US00D642397S

(12) **United States Design Patent**  
**Colombo**

(10) **Patent No.:** **US D642,397 S**

(45) **Date of Patent:** **\*\* Aug. 2, 2011**

(54) **BED**

(75) **Inventor:** **Carlo Colombo**, Carimate (IT)

(73) **Assignee:** **Flou S.p.A.**, Meda (Milano) (IT)

(\*\*) **Term:** **14 Years**

(21) **Appl. No.:** **29/345,640**

(22) **Filed:** **Oct. 20, 2009**

(30) **Foreign Application Priority Data**

Apr. 22, 2009 (IT) ..... 001128847-0004

(51) **LOC (9) Cl.** ..... **06-02**

(52) **U.S. Cl.** ..... **D6/393**

(58) **Field of Classification Search** ..... D6/383,  
D6/388, 392-395, 505-508, 492, 494; 5/53.1,  
5/907, 279.1, 280, 281, 2.1, 600, 612, 620

See application file for complete search history.

(56) **References Cited**

U.S. PATENT DOCUMENTS

D164,058 S *	7/1951	Perry .....	D6/393
D184,856 S *	4/1959	Dresber .....	D6/505
D532,988 S *	12/2006	Dordoni .....	D6/393
D613,519 S *	4/2010	Sadler .....	D6/393

\* cited by examiner

*Primary Examiner* — Janice Seeger

(74) *Attorney, Agent, or Firm* — Lucas & Mercanti, LLP

(57) **CLAIM**

The ornamental design for a bed, as shown and described.

**DESCRIPTION**

FIG. 1 is a perspective view of a bed showing my new design;  
FIG. 2 is a right side perspective view thereof;  
FIG. 3 is a left side perspective view thereof;  
FIG. 4 is a front perspective view thereof;  
FIG. 5 is a rear perspective view thereof; and,  
FIG. 6 is a top perspective view thereof.  
The bottom of the bed not shown forms no part of the claimed design.

**1 Claim, 4 Drawing Sheets**

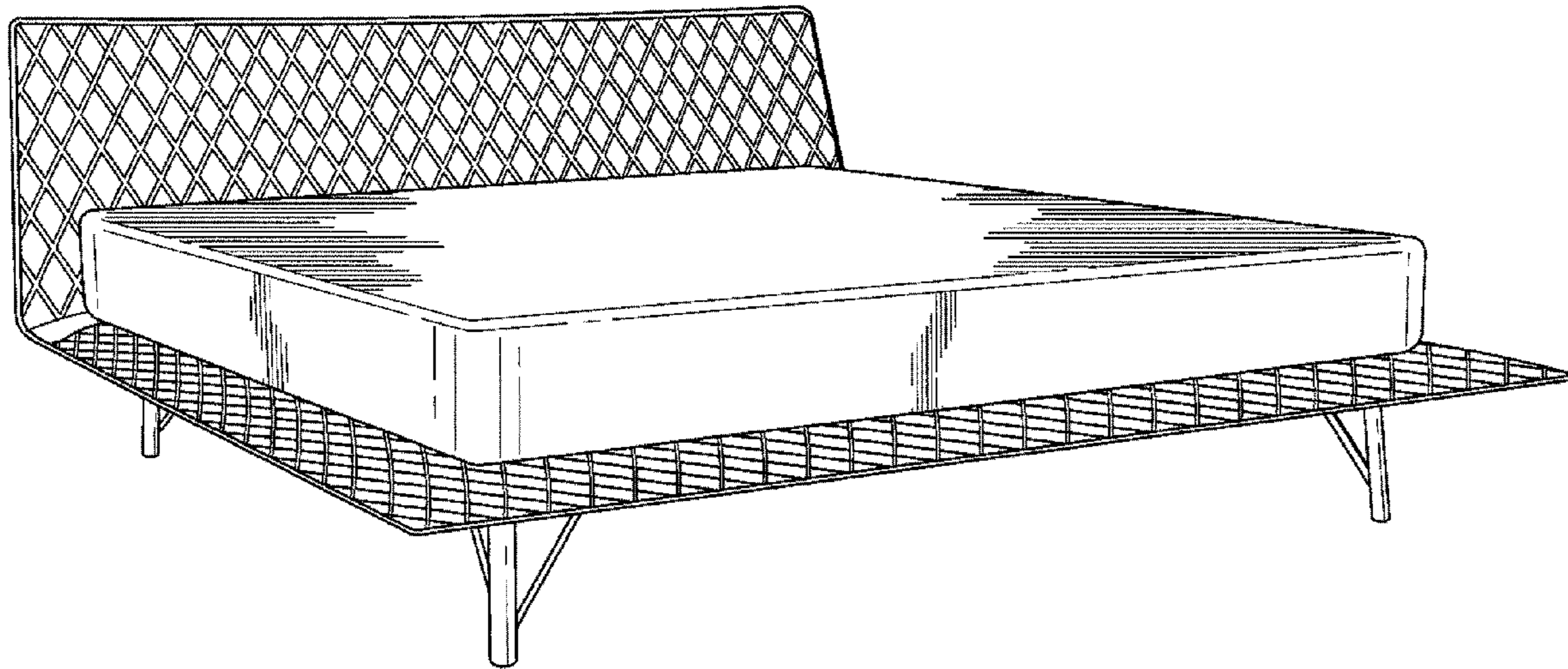

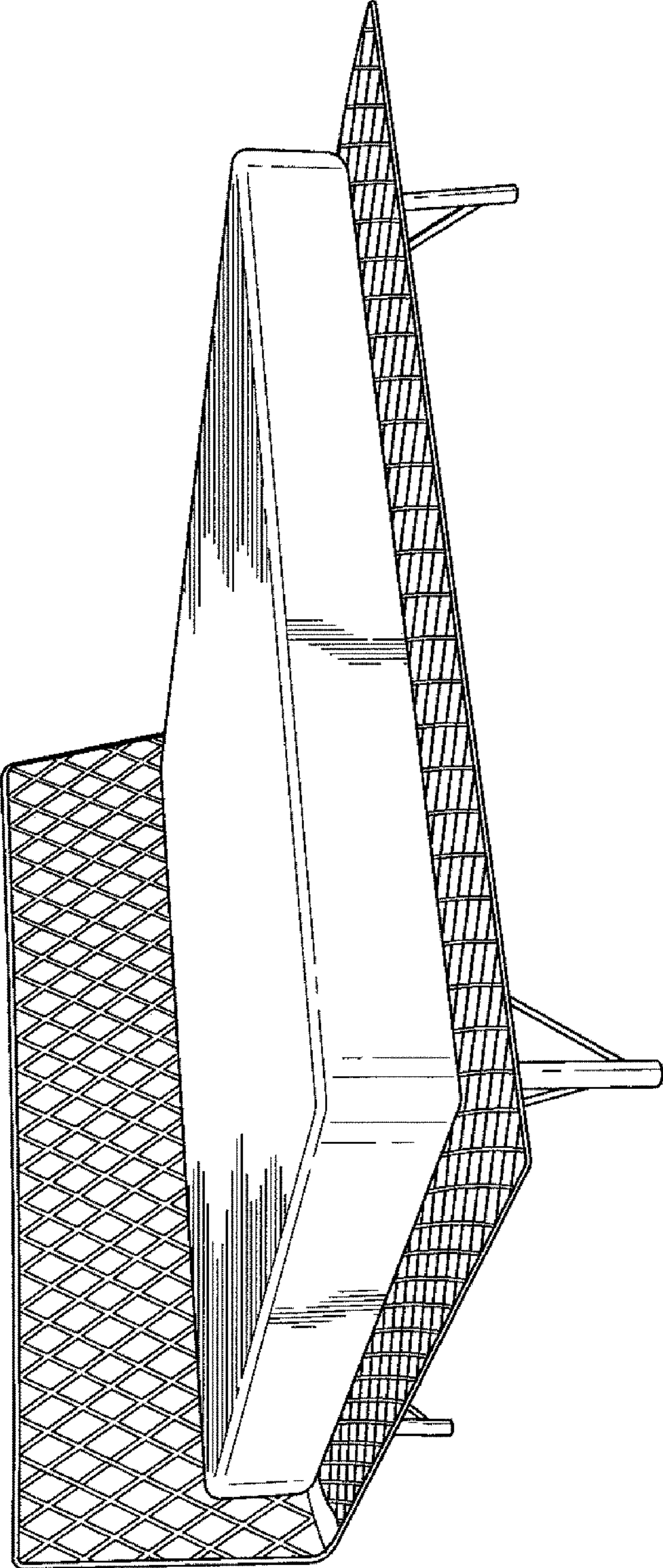

FIG. 1

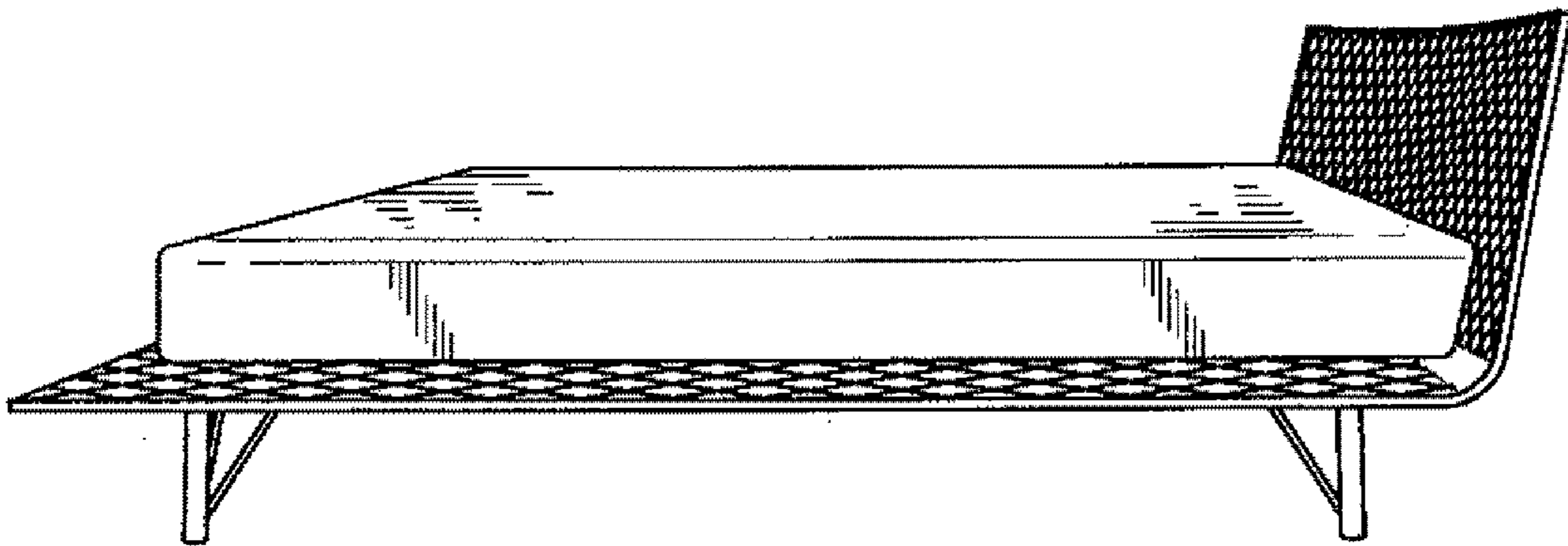

FIG. 2

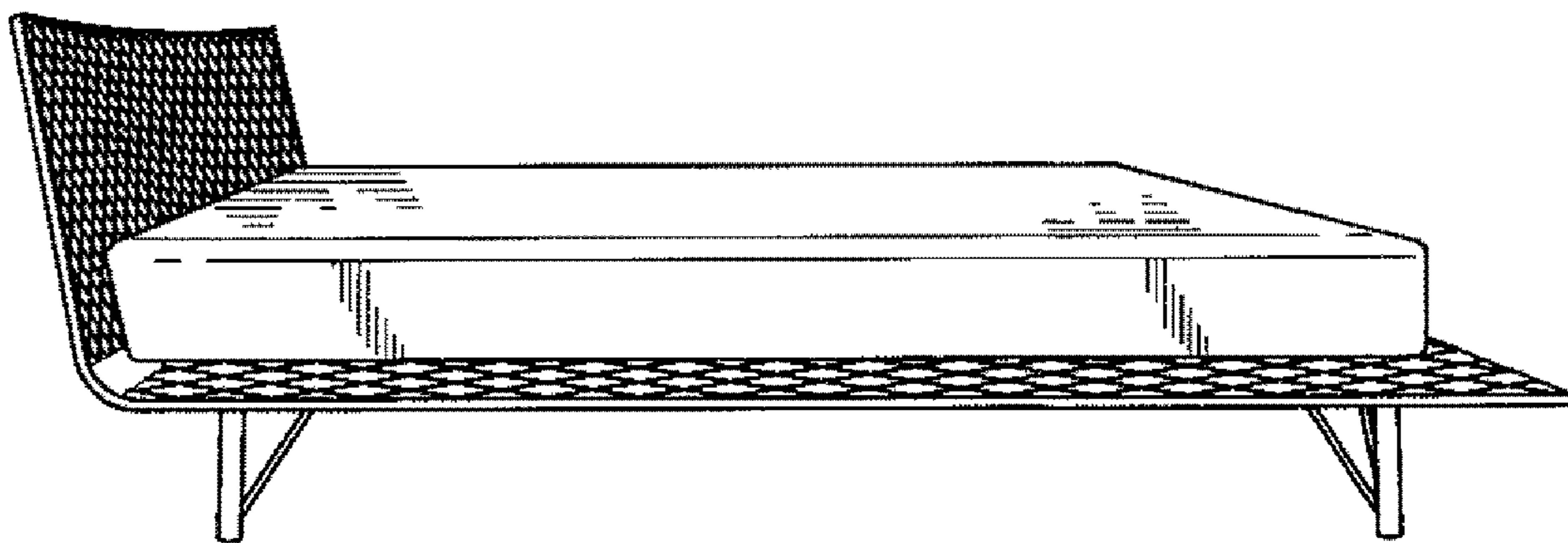

FIG. 3

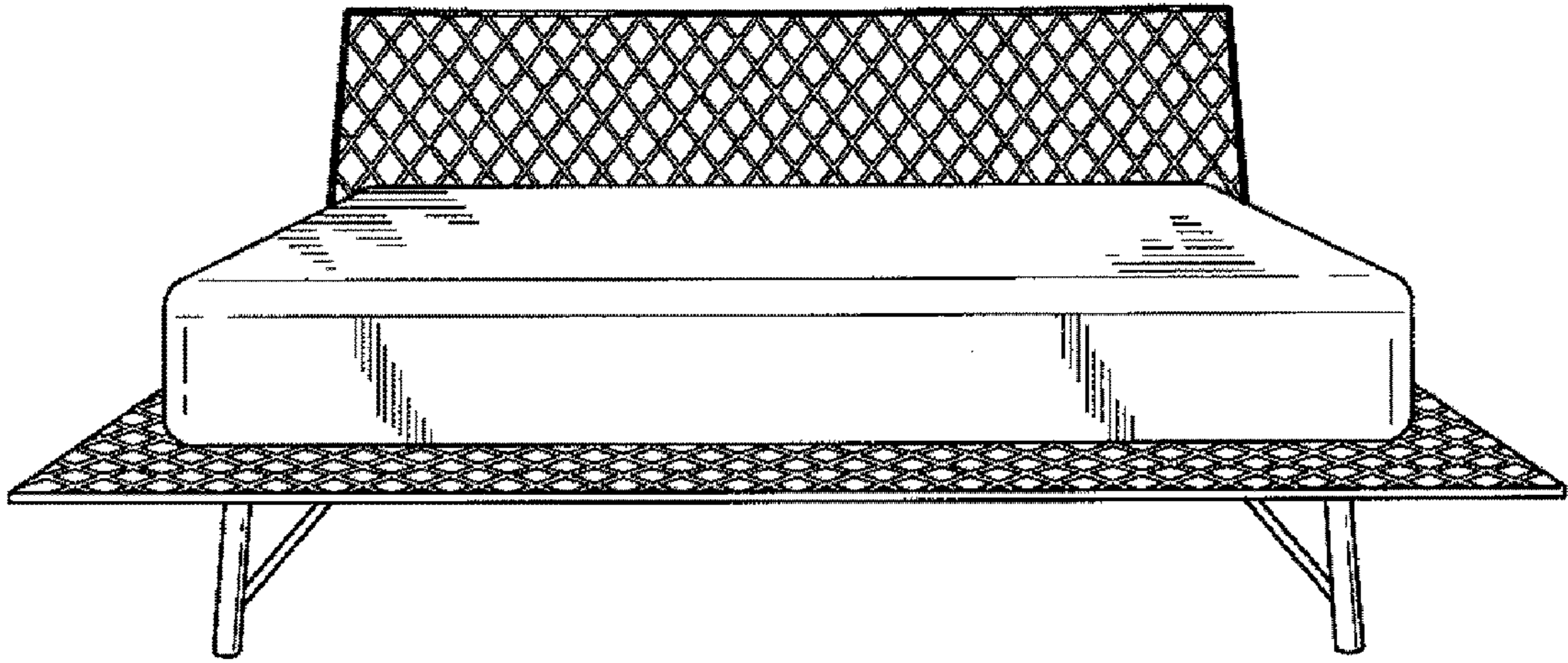

FIG. 4

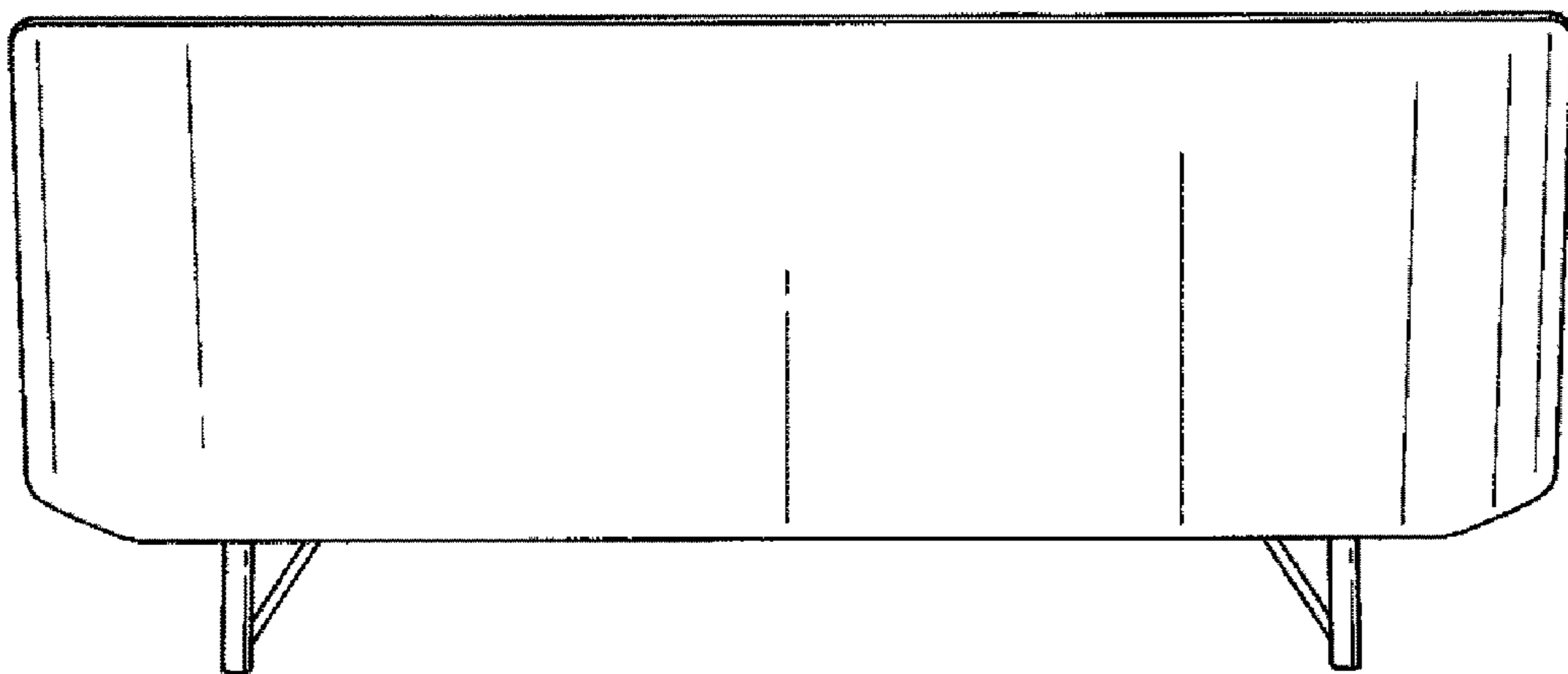

FIG. 5

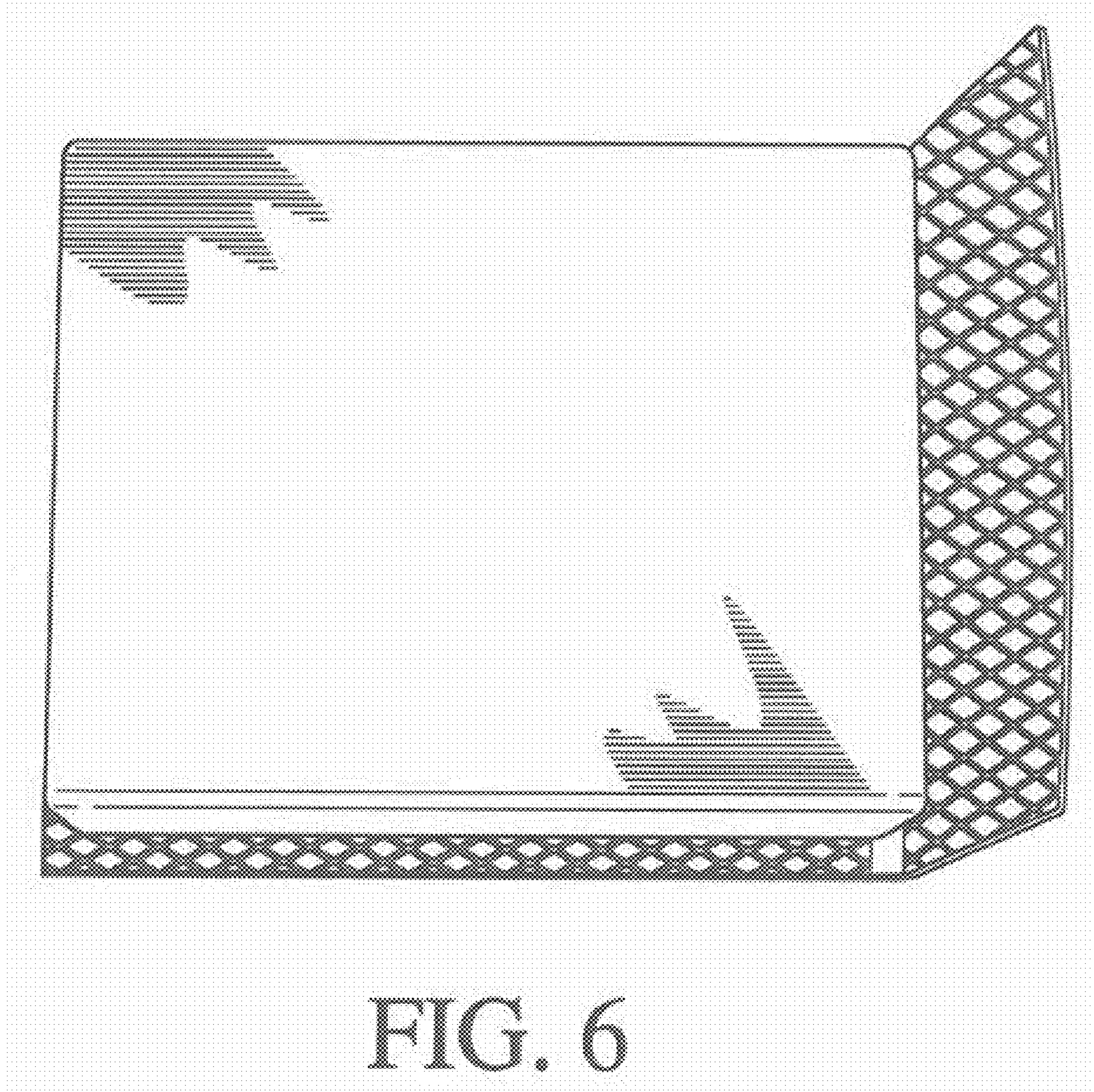

FIG. 6