

US00D642287S

(12) **United States Design Patent**
Poland

(10) **Patent No.:** **US D642,287 S**

(45) **Date of Patent:** **** Jul. 26, 2011**

(54) **TONGUE AND GROOVE FLOORING TILE**

(76) Inventor: **Neil Poland**, Johnson City, TN (US)

(**) Term: **14 Years**

(21) Appl. No.: **29/349,424**

(22) Filed: **Apr. 1, 2010**

(51) **LOC (9) Cl.** **25-01**

(52) **U.S. Cl.** **D25/119; D25/138**

(58) **Field of Classification Search** D25/145,
D25/150, 157, 158, 163, 138, 113, 119; 52/306,
52/311.1, 311.2, 314, 316, 390, 384, 392,
52/403.1, 386, 391, 605, 602, 579, 588.1,
52/591.4, 600; 428/38, 50, 49, 106; 404/34,
404/39, 42, 46, 41, 50

See application file for complete search history.

(56) **References Cited**

U.S. PATENT DOCUMENTS

2,289,634 A * 7/1942 Dieter 52/597
2,316,232 A * 4/1943 Fischer 52/309.13

5,827,592 A * 10/1998 Van Gulik et al. 428/44
D419,697 S * 1/2000 Kroesbergen D25/138
D515,712 S * 2/2006 Poliacek et al. D25/119

* cited by examiner

Primary Examiner — Doris Clark

(57) **CLAIM**

I claim the ornamental design for a tongue and groove flooring tile, as shown and described.

DESCRIPTION

FIG. 1 is a side and top perspective view of a tongue and groove flooring tile showing my new design;
FIG. 2 is a side and bottom perspective view thereof;
FIG. 3 is a top plan view thereof;
FIG. 4 is a side view thereof showing the groove;
FIG. 5 is the opposite side view showing the tongue;
FIG. 6 is a bottom plan view thereof;
FIG. 7 is an end view showing the tongue; and,
FIG. 8 is the opposite end view showing the groove.
The broken lines are disclosed to show indeterminate width and length of the claimed design.

1 Claim, 4 Drawing Sheets

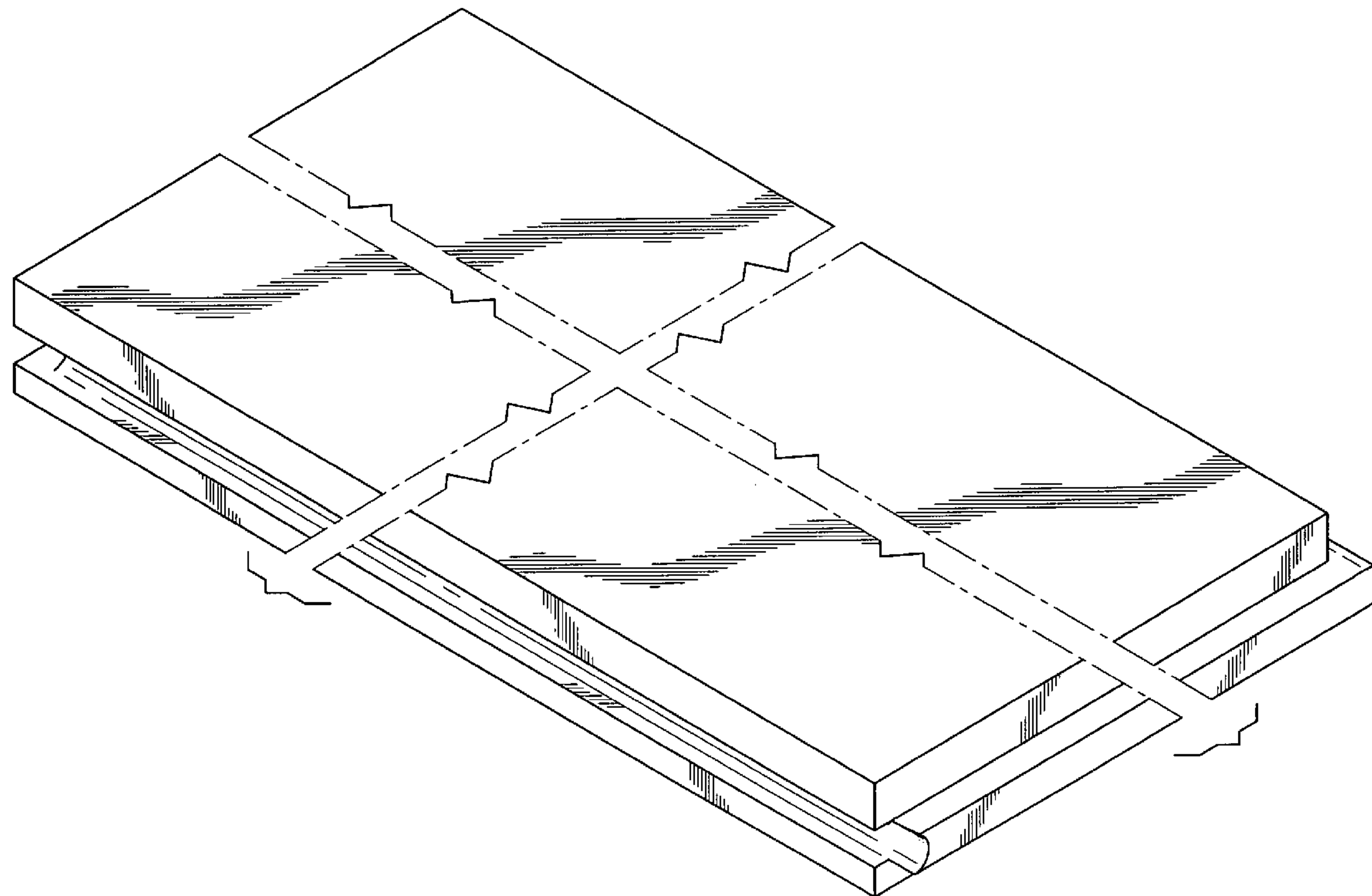

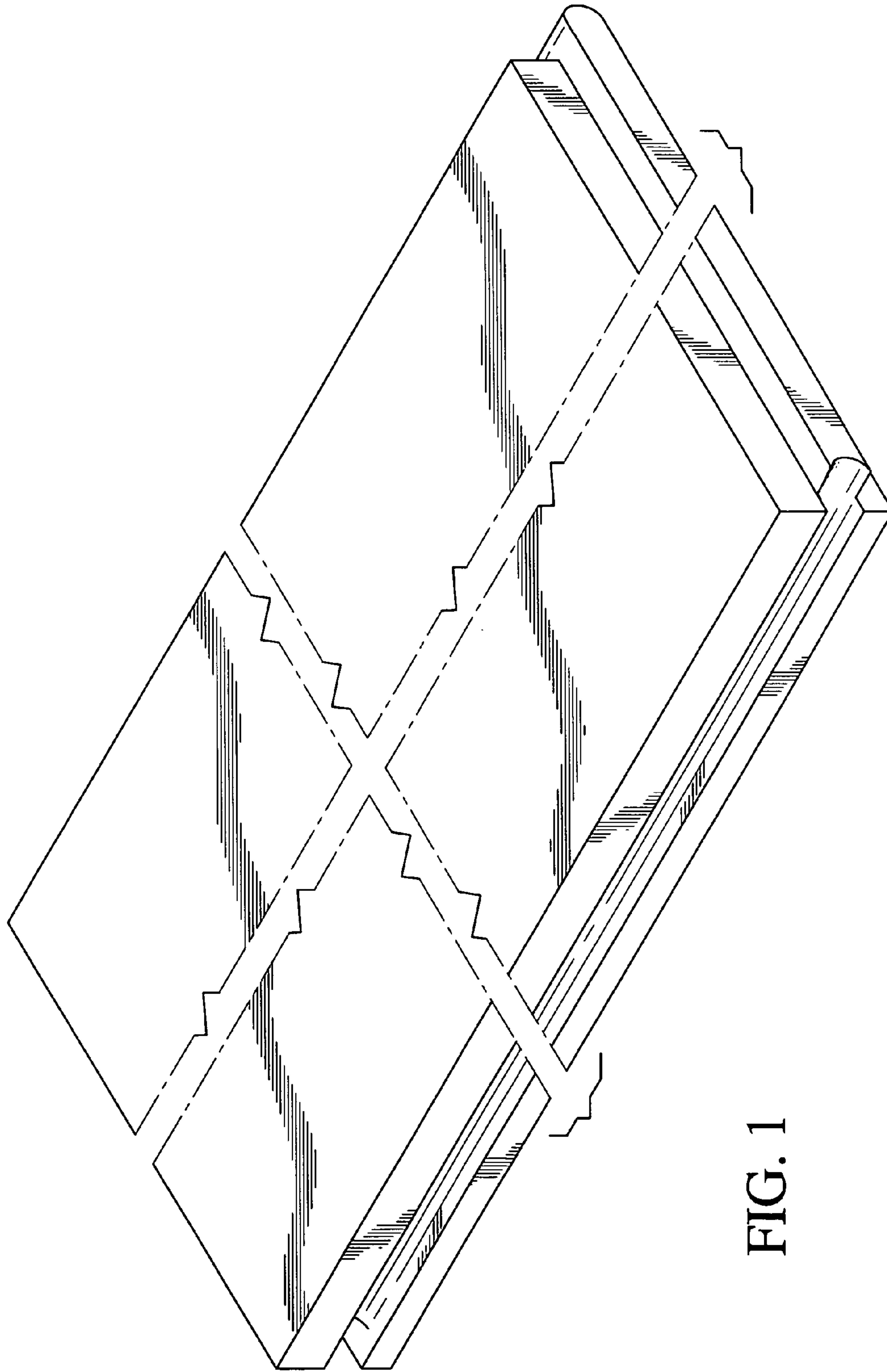

FIG. 1

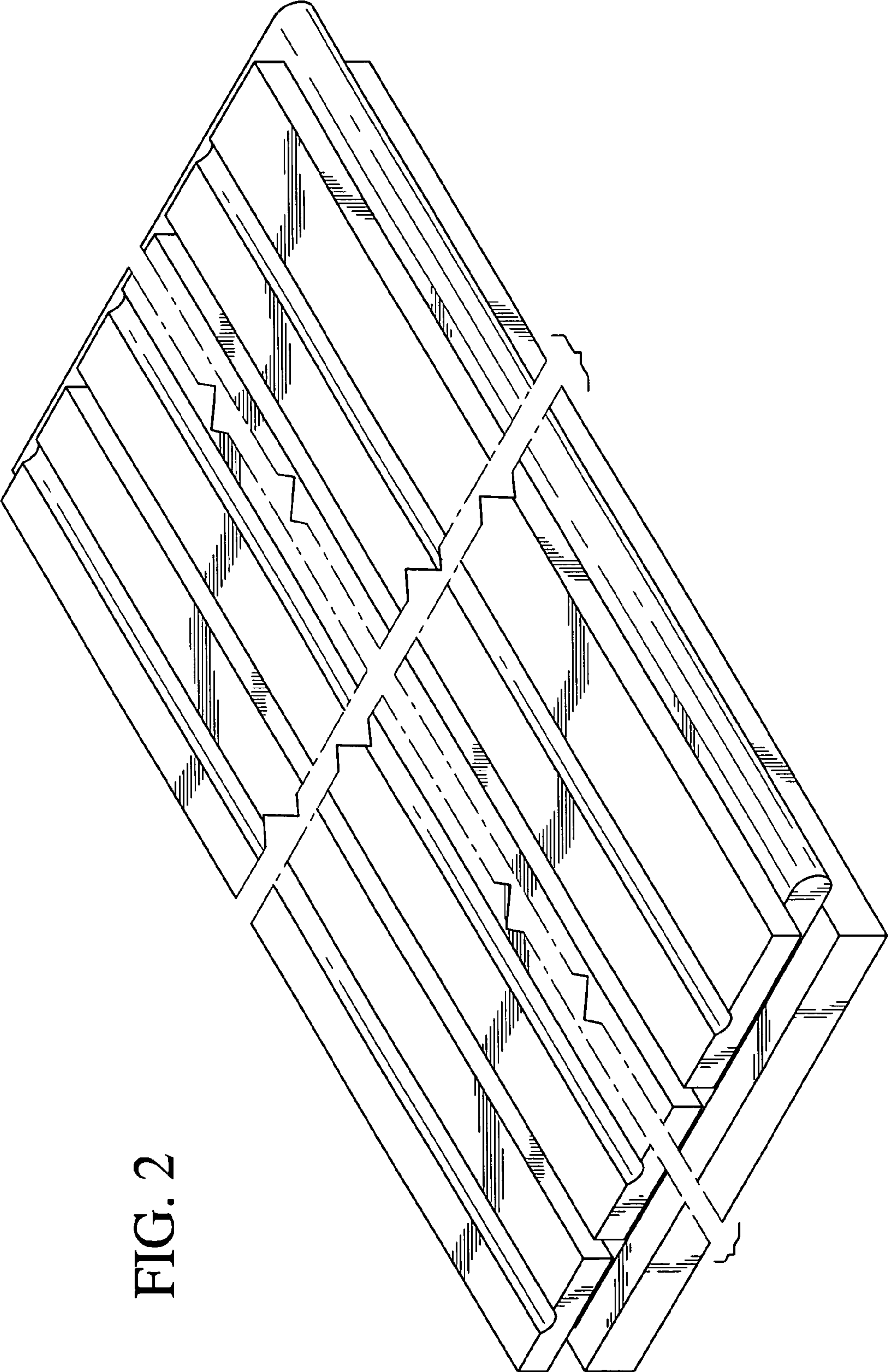

FIG. 2

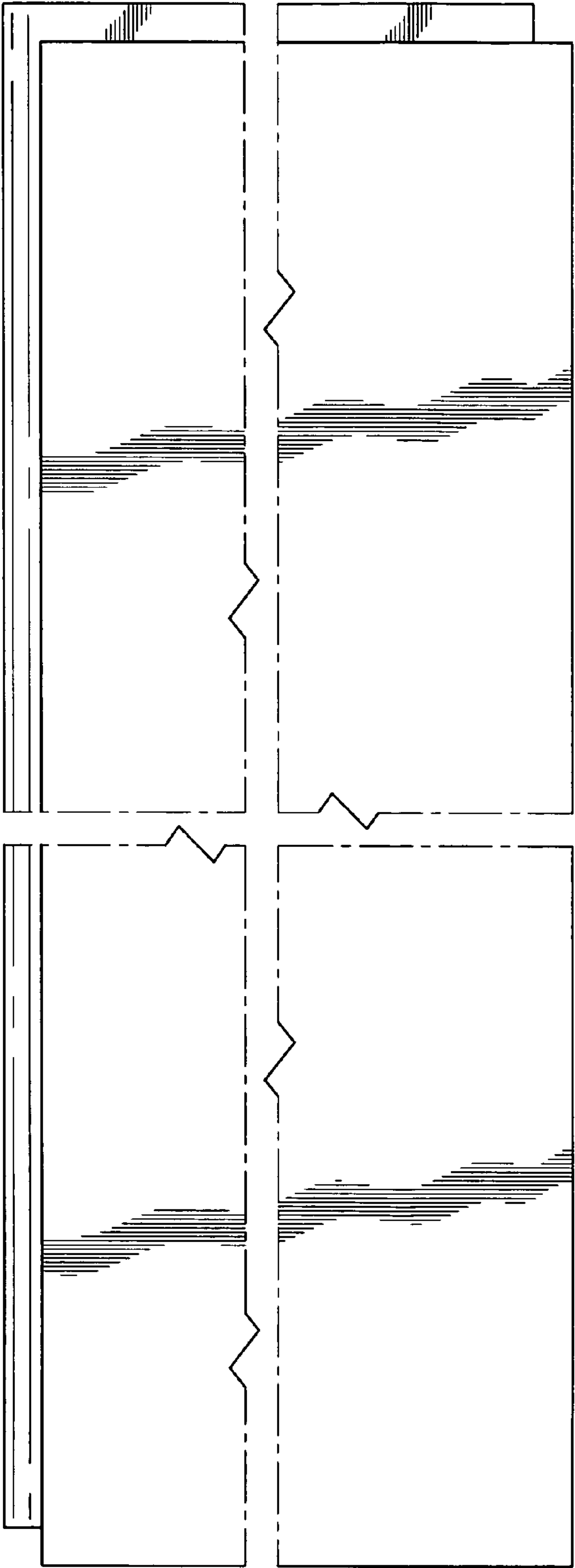

FIG. 3



FIG. 4

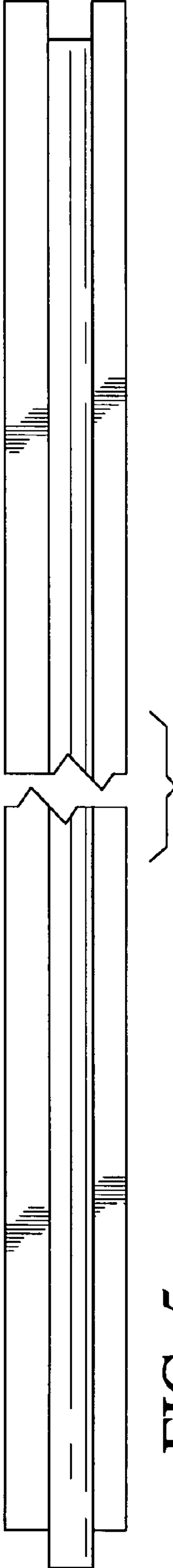

FIG. 5

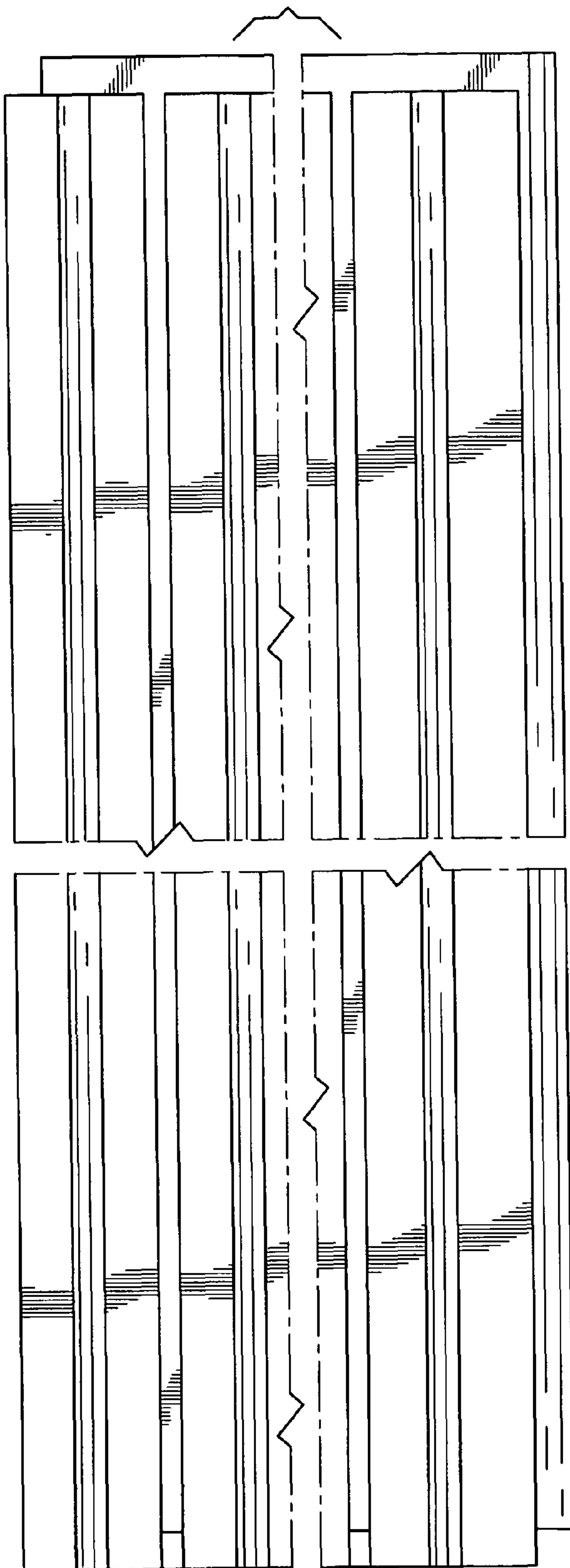

FIG. 6

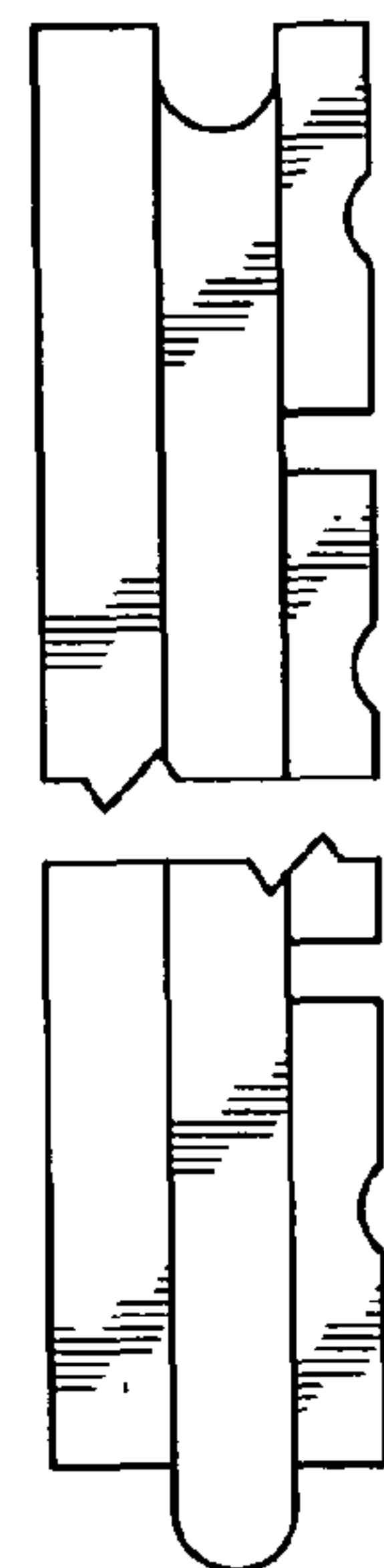

FIG. 8

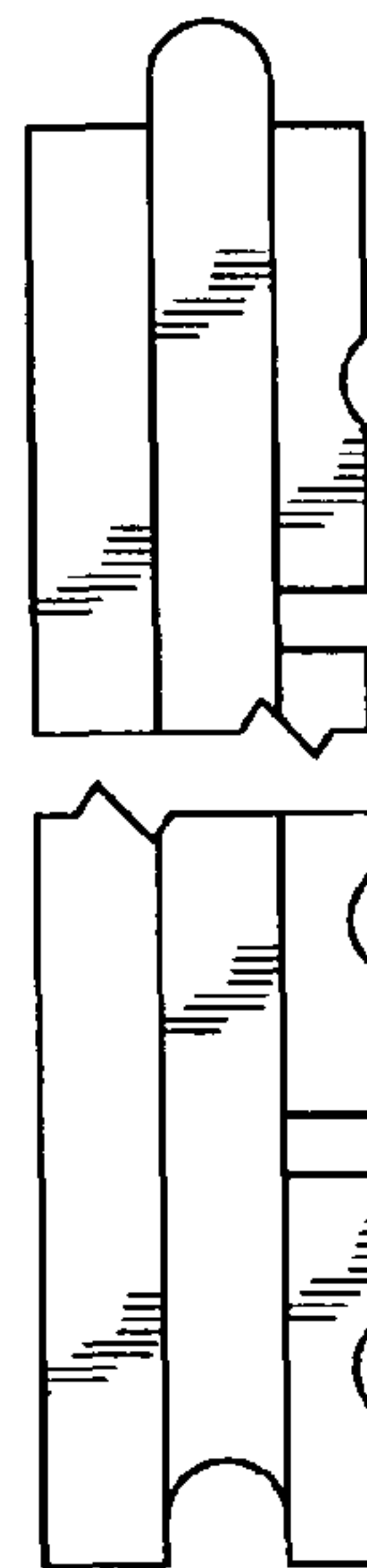

FIG. 7

UNITED STATES PATENT AND TRADEMARK OFFICE
CERTIFICATE OF CORRECTION

PATENT NO. : D642,287 S
APPLICATION NO. : 29/349424
DATED : July 26, 2011
INVENTOR(S) : Neil Poland

Page 1 of 1

It is certified that error appears in the above-identified patent and that said Letters Patent is hereby corrected as shown below:

Amend the title (col. 1, line 1) from “TONGUE AND GROOVE FLOORING TILE” to
--TONGUE AND GROOVE FLOORING BOARD--; and

In line 2 of the claim (col. 2, line 8) delete “tile” and substitute therefor --board--;
and

In line 2 of the description (col. 2, line 11) of FIG. 1 delete “tile” and substitute therefor
--board--.

Signed and Sealed this
Third Day of April, 2012

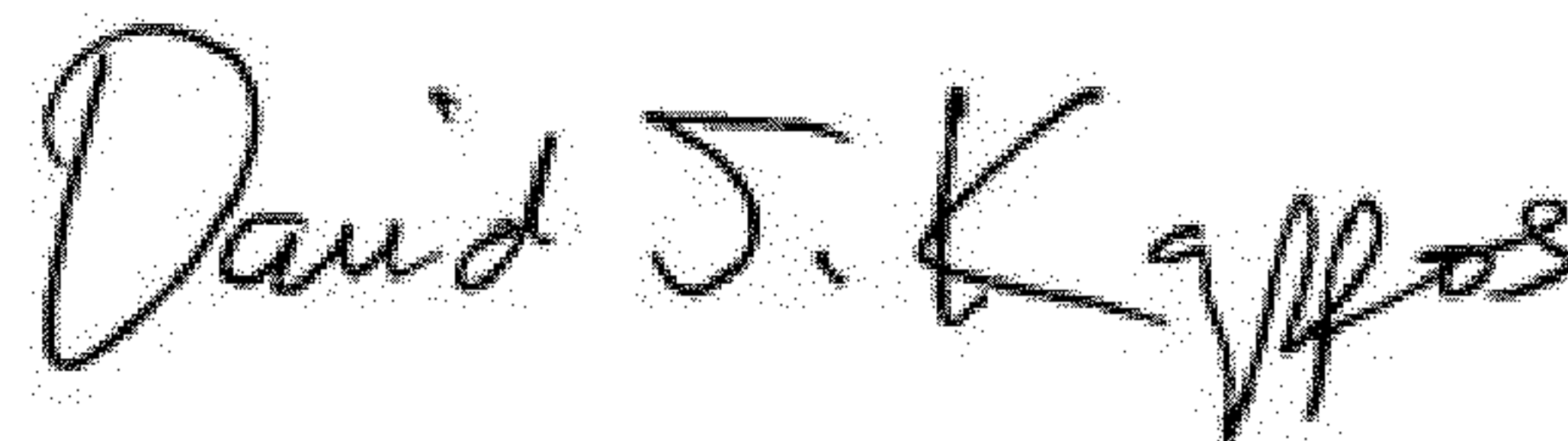

David J. Kappos
Director of the United States Patent and Trademark Office