

US00D642255S

(12) **United States Design Patent**
Mazzeo et al.

(10) **Patent No.:** **US D642,255 S**
(45) **Date of Patent:** **** Jul. 26, 2011**

(54) **AIR FRESHENER**

(75) Inventors: **Edoardo Mazzeo**, Civezzano (IT); **Oriol Boadella Esteve**, Barcelona (ES); **Jose Antonio Luque Salcedo**, Barcelona (ES)

(73) Assignee: **Zobeles Espana, S.A.**, Barcelona (ES)

(**) Term: **14 Years**

(21) Appl. No.: **29/379,469**

(22) Filed: **Nov. 19, 2010**

(30) **Foreign Application Priority Data**

May 21, 2010 (EM) 001710666-0002

(51) **LOC (9) Cl.** **28-99**

(52) **U.S. Cl.** **D23/366**

(58) **Field of Classification Search** D23/355-369;
D28/5, 6; 261/DIG. 17, DIG. 42, DIG. 65,
261/DIG. 88, DIG. 89; 392/386, 390-395;
239/34, 35, 44-47, 50, 53, 56, 60, 145, 326

See application file for complete search history.

(56) **References Cited**

U.S. PATENT DOCUMENTS

D385,024	S	*	10/1997	Roberts	D23/366
D508,284	S	*	8/2005	Butler et al.	D23/366
D532,093	S	*	11/2006	Helf et al.	D23/366
D534,640	S	*	1/2007	Helf et al.	D23/366
D591,415	S	*	4/2009	Wu	D23/366
D596,731	S	*	7/2009	Garcia Fabrega et al.	D23/366
D631,954	S	*	2/2011	Bertassi et al.	D23/366

* cited by examiner

Primary Examiner — Sandra Snapp

(74) *Attorney, Agent, or Firm* — Katten Muchin Roseman LLP

(57) **CLAIM**

The ornamental design for an air freshener, as shown and described.

DESCRIPTION

FIG. 1 is a perspective view of the air freshener
FIG. 2 is a front view thereof,
FIG. 3 is a rear view thereof,
FIG. 4 is a left-side view thereof,
FIG. 5 is a right-side view thereof,
FIG. 6 is a top view thereof; and,
FIG. 7 is a bottom view thereof.

1 Claim, 7 Drawing Sheets

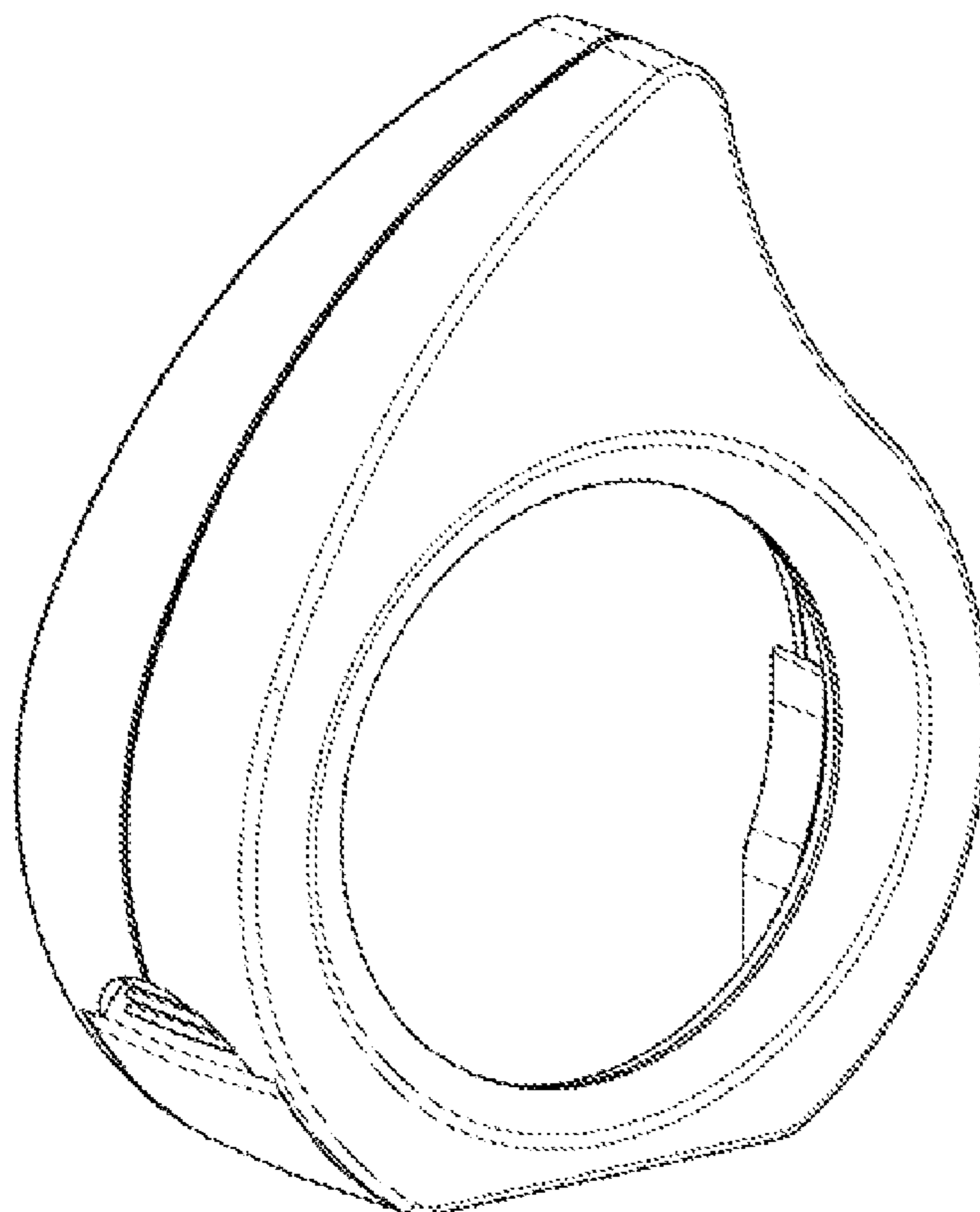

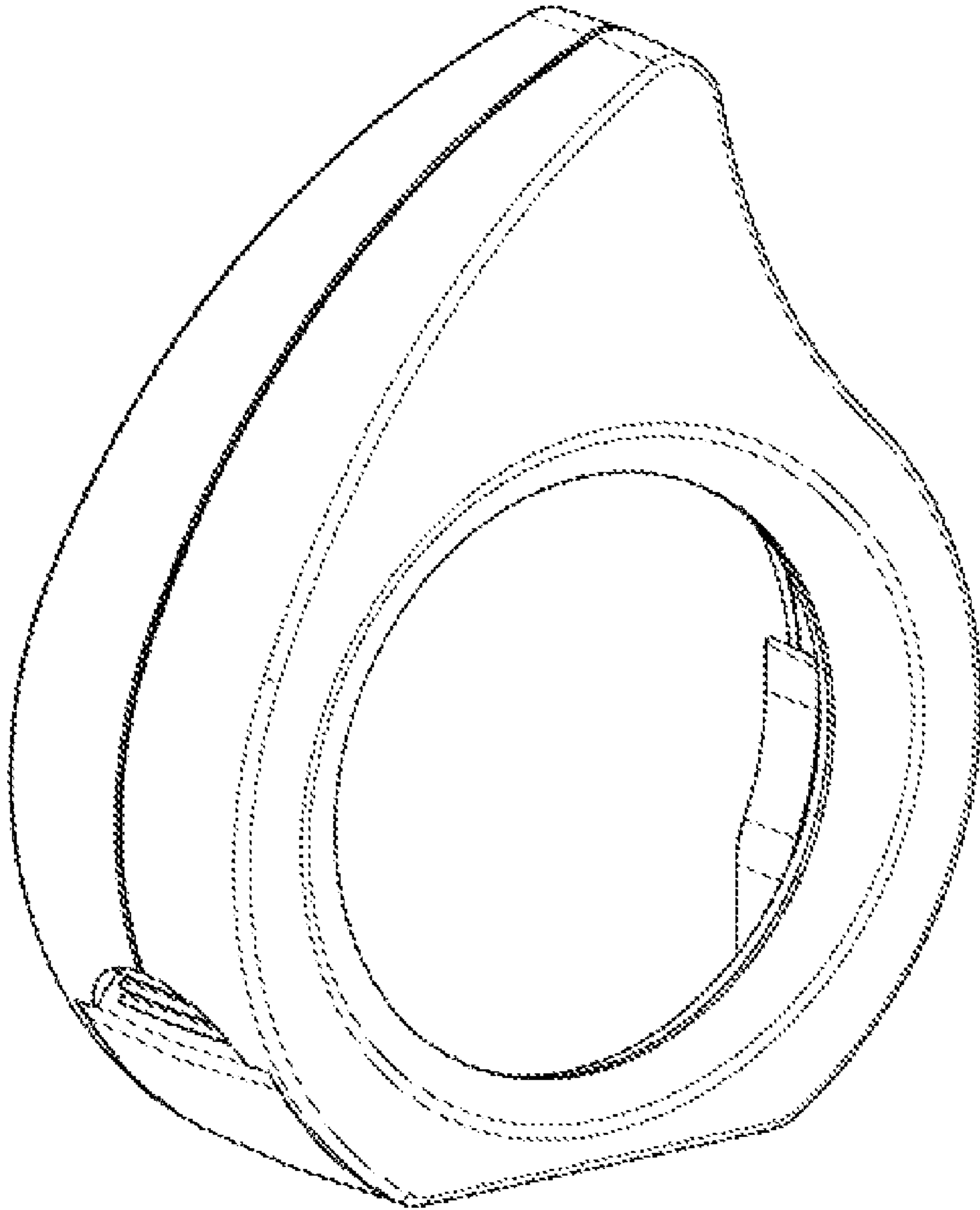

FIG. 1

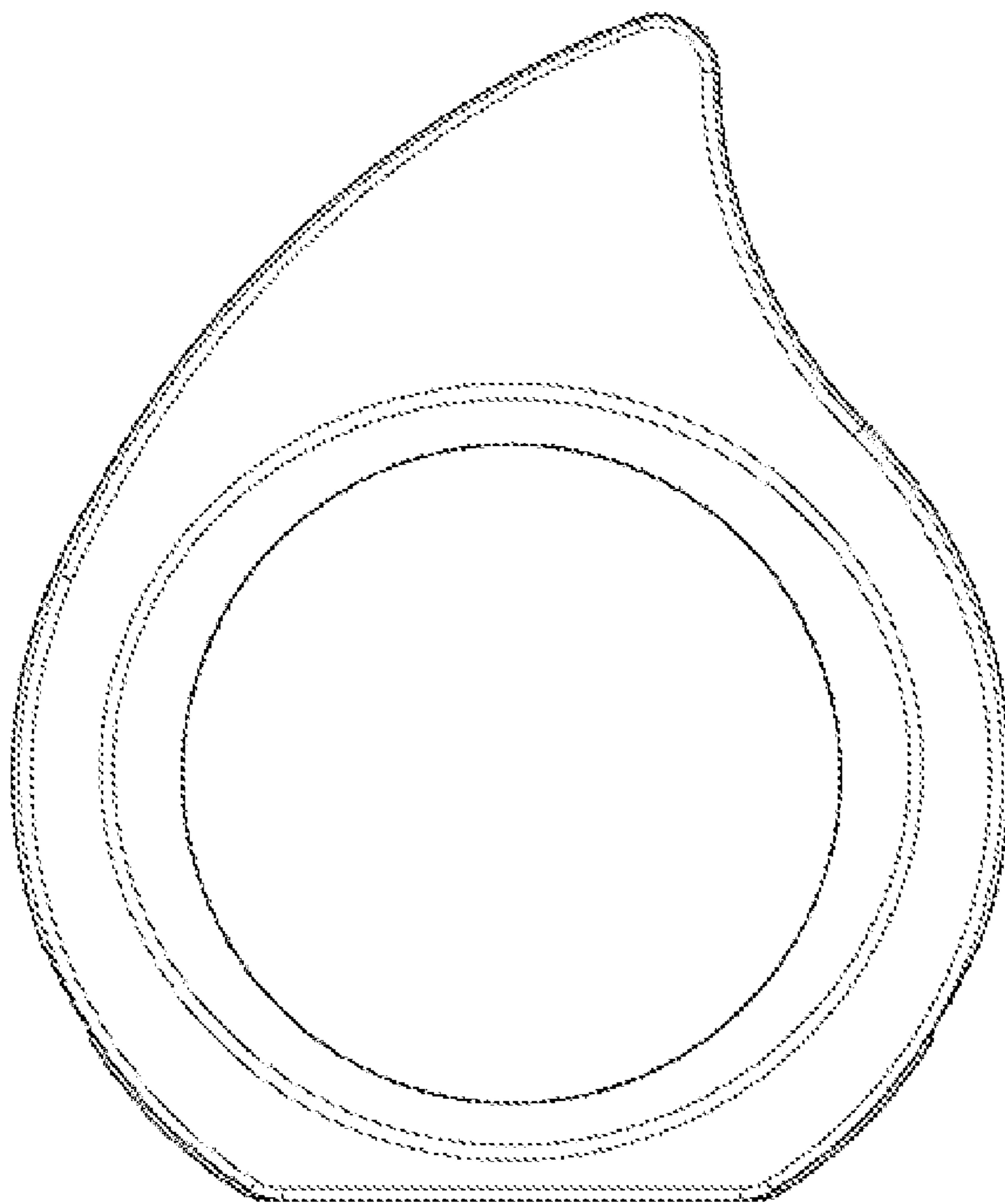

FIG. 2

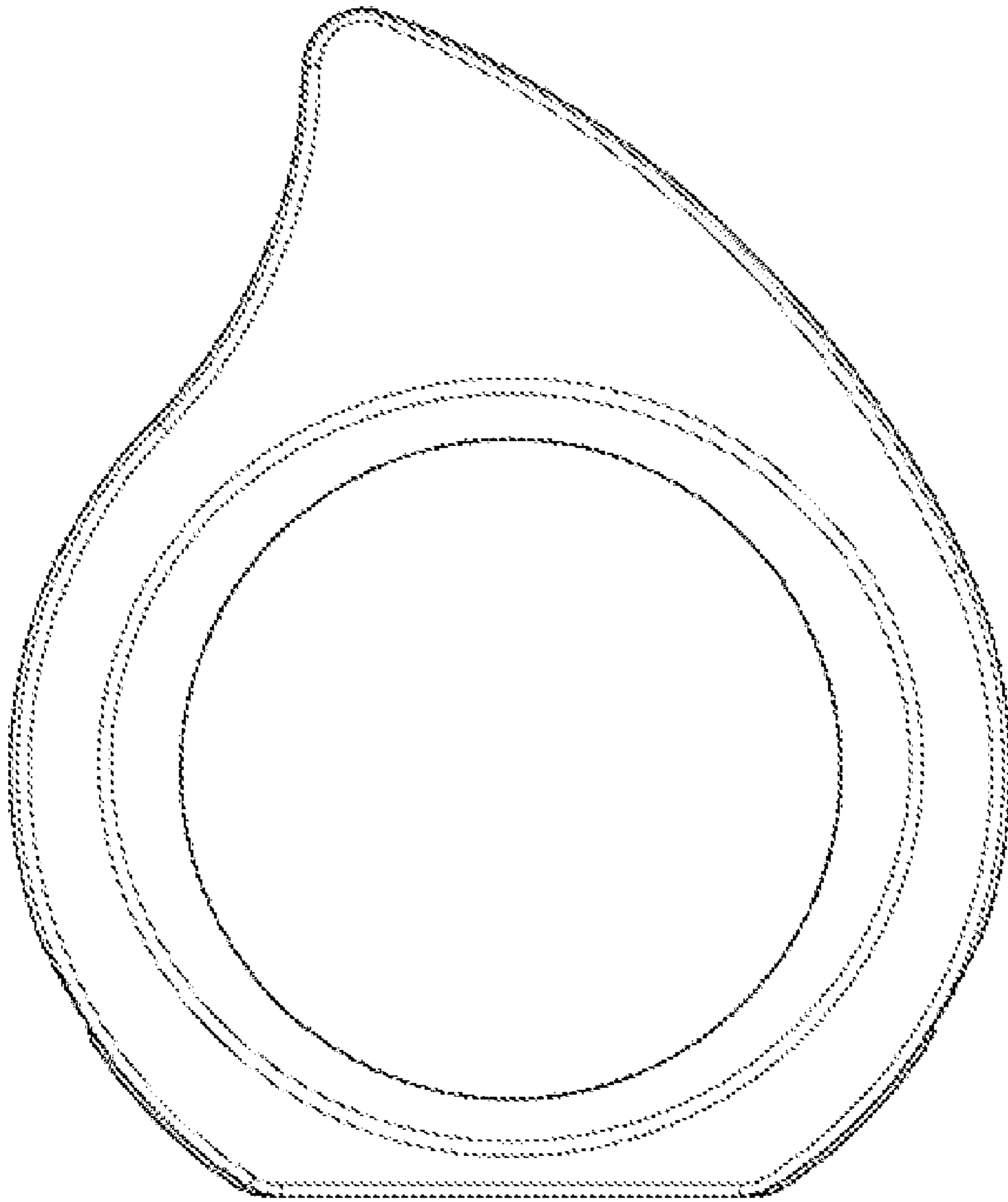

FIG. 3

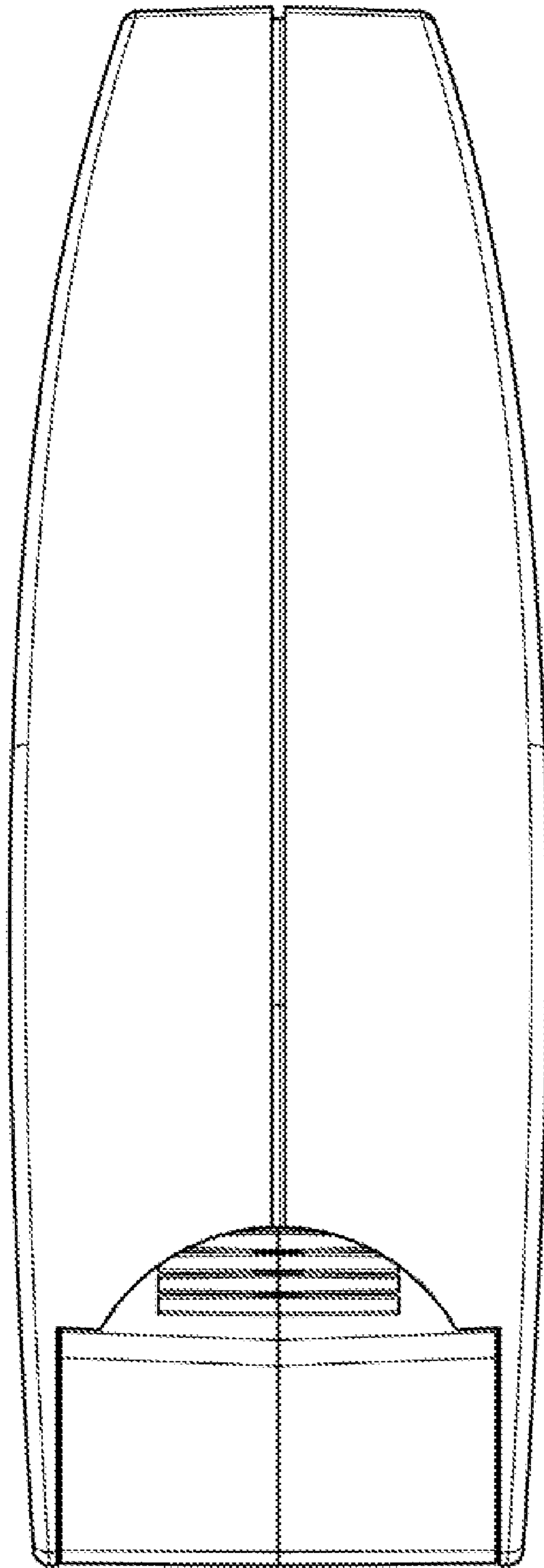

FIG. 4

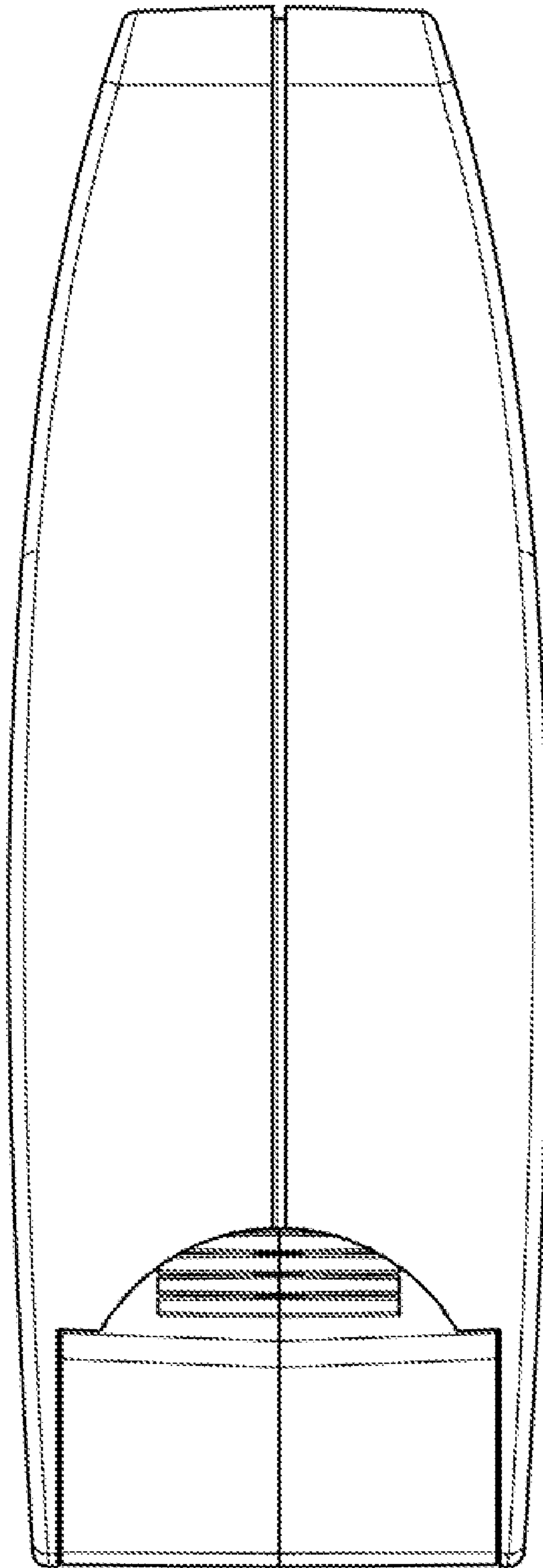

FIG. 5

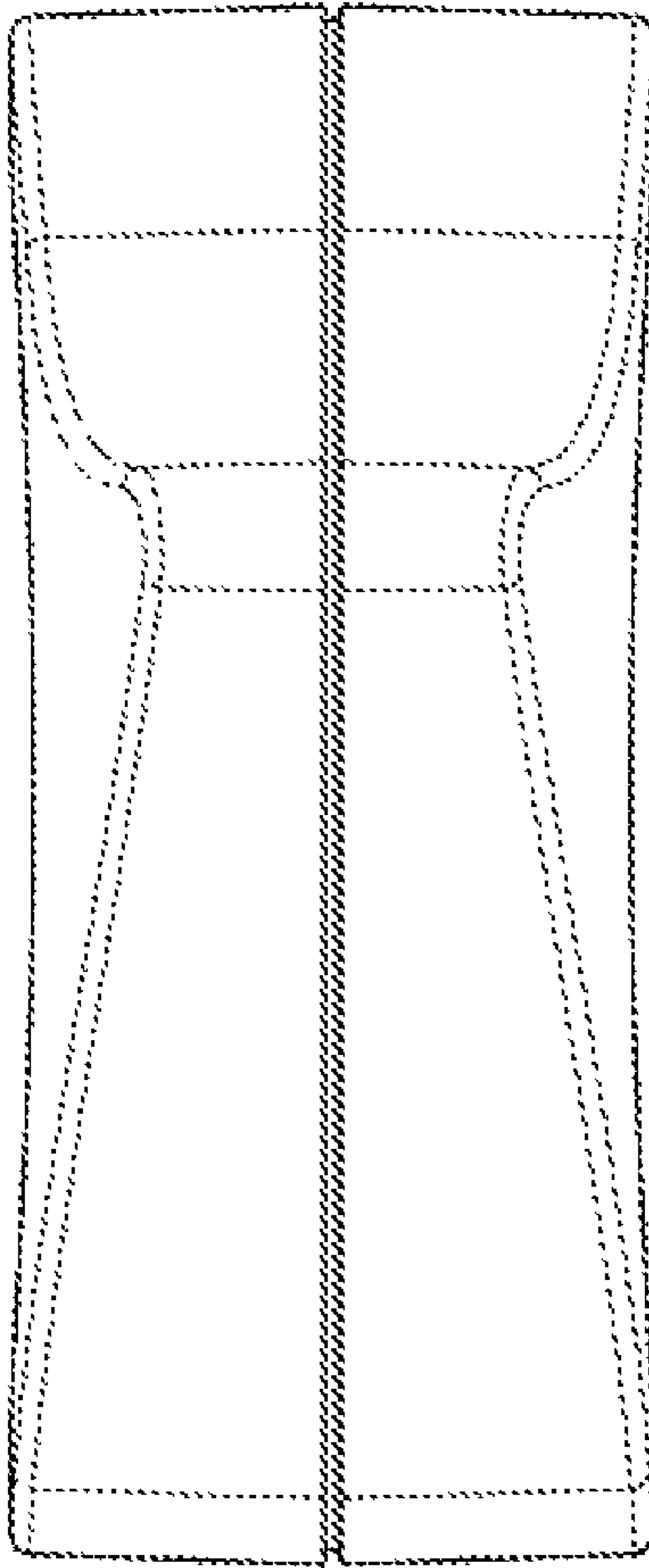

FIG. 6

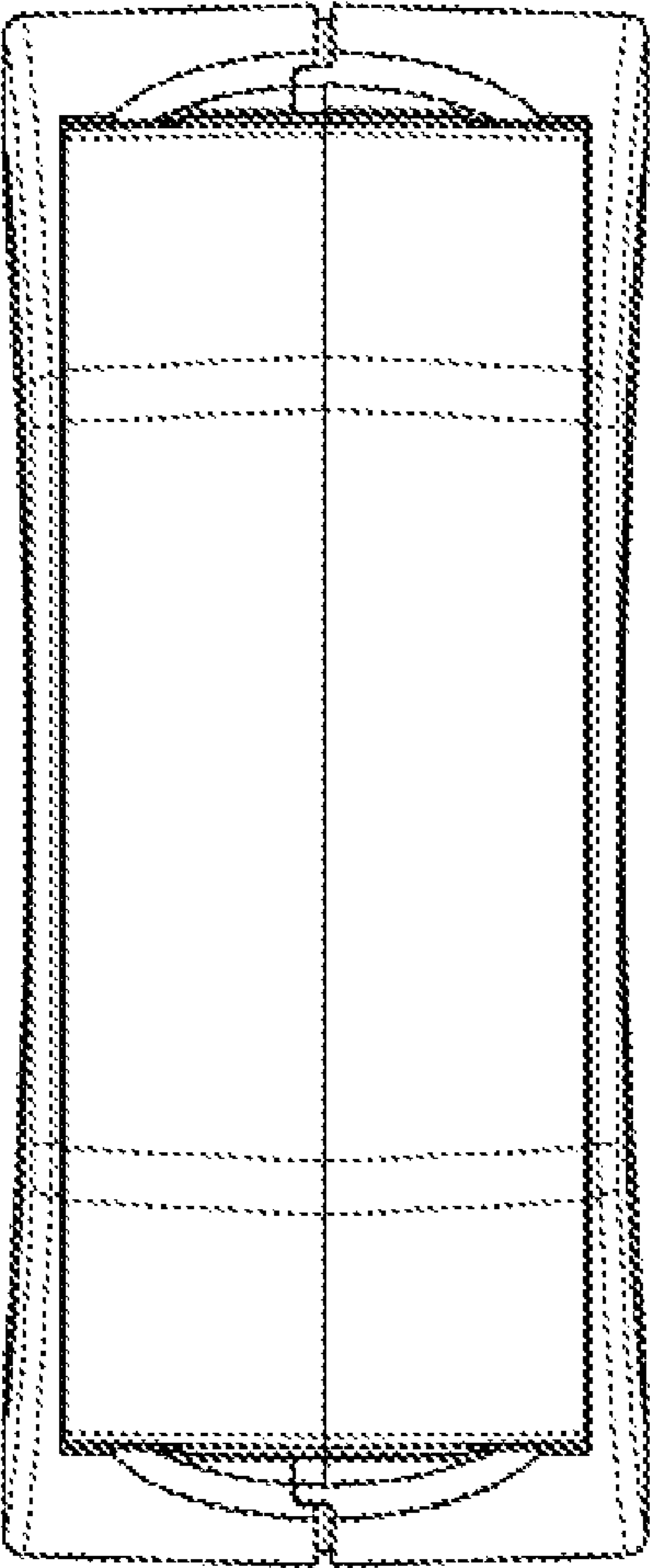

FIG. 7