



US00D642234S

(12) **United States Design Patent**
Marfione et al.

(10) **Patent No.:** **US D642,234 S**

(45) **Date of Patent:** **** Jul. 26, 2011**

(54) **MAGAZINE**

(75) Inventors: **Anthony Marfione**, Ashville, NC (US);
David J. Reiser, West Springfield, PA
(US)

(73) Assignee: **Microtech Small Arms Research**,
Fletcher, NC (US)

(**) Term: **14 Years**

(21) Appl. No.: **29/361,735**

(22) Filed: **May 14, 2010**

(51) **LOC (9) Cl.** **22-01**

(52) **U.S. Cl.** **D22/108; D22/104**

(58) **Field of Classification Search** D22/100–116;
D21/572–573; 124/66, 67, 74; 42/51, 71.01,
42/75.01, 75.02, 90, 94; 362/110; 89/40.06,
89/37.04, 33.04, 191.01

See application file for complete search history.

(56) **References Cited**

U.S. PATENT DOCUMENTS

2,927,390	A *	3/1960	Lewis	42/65
3,758,978	A *	9/1973	Theodore	42/71.02
4,343,107	A *	8/1982	Kaltenegger	42/7
4,549,465	A *	10/1985	Charron	89/196
5,050,480	A *	9/1991	Knight et al.	89/147
5,526,600	A *	6/1996	Chesnut et al.	42/50
D428,101	S *	7/2000	Rost et al.	D22/108
D464,702	S *	10/2002	Mauch et al.	D22/104
D487,791	S *	3/2004	Freed	D22/108
D493,861	S *	8/2004	Rauch et al.	D22/108
D574,053	S *	7/2008	McGarry	D22/104
D579,072	S *	10/2008	McGarry	D22/104
7,533,483	B1 *	5/2009	Alzamora et al.	42/50
D627,028	S *	11/2010	Coulombier	D22/104
2004/0031181	A1 *	2/2004	Freed	42/71.02

* cited by examiner

Primary Examiner — T. Chase Nelson

Assistant Examiner — Michael Pratt

(74) *Attorney, Agent, or Firm* — Cohen & Grigsby, P.C.

(57) **CLAIM**

The ornamental design for a magazine, as shown and described.

DESCRIPTION

FIG. 1 is a front perspective view of the first embodiment of the magazine embodying our new design as claimed herein. FIG. 2 is rear perspective view of the magazine shown in FIG. 1.

FIG. 3 is a left side view of the magazine shown in FIG. 1.

FIG. 4 is a right side view of the magazine shown in FIG. 1.

FIG. 5 is a rear elevational view of the magazine shown in FIG. 1.

FIG. 6 is a front elevational view of the magazine shown in FIG. 1.

FIG. 7 is a top plan view of the magazine shown in FIG. 1.

FIG. 8 is a bottom plan view of the magazine shown in FIG. 1.

FIG. 9 is a front perspective view of a second embodiment of the magazine shown in FIG. 1.

FIG. 10 is a left side view of the magazine shown in FIG. 9.

FIG. 11 is a front perspective view of an alternate embodiment of the magazine shown in FIG. 1.

FIG. 12 is a left side view of the magazine shown in FIG. 11; and,

FIG. 13 is a side view of an alternate embodiment of the magazine shown in FIG. 1.

The broken lines shown in the drawings are for illustrative purposes only and form no part of the claimed design.

1 Claim, 10 Drawing Sheets

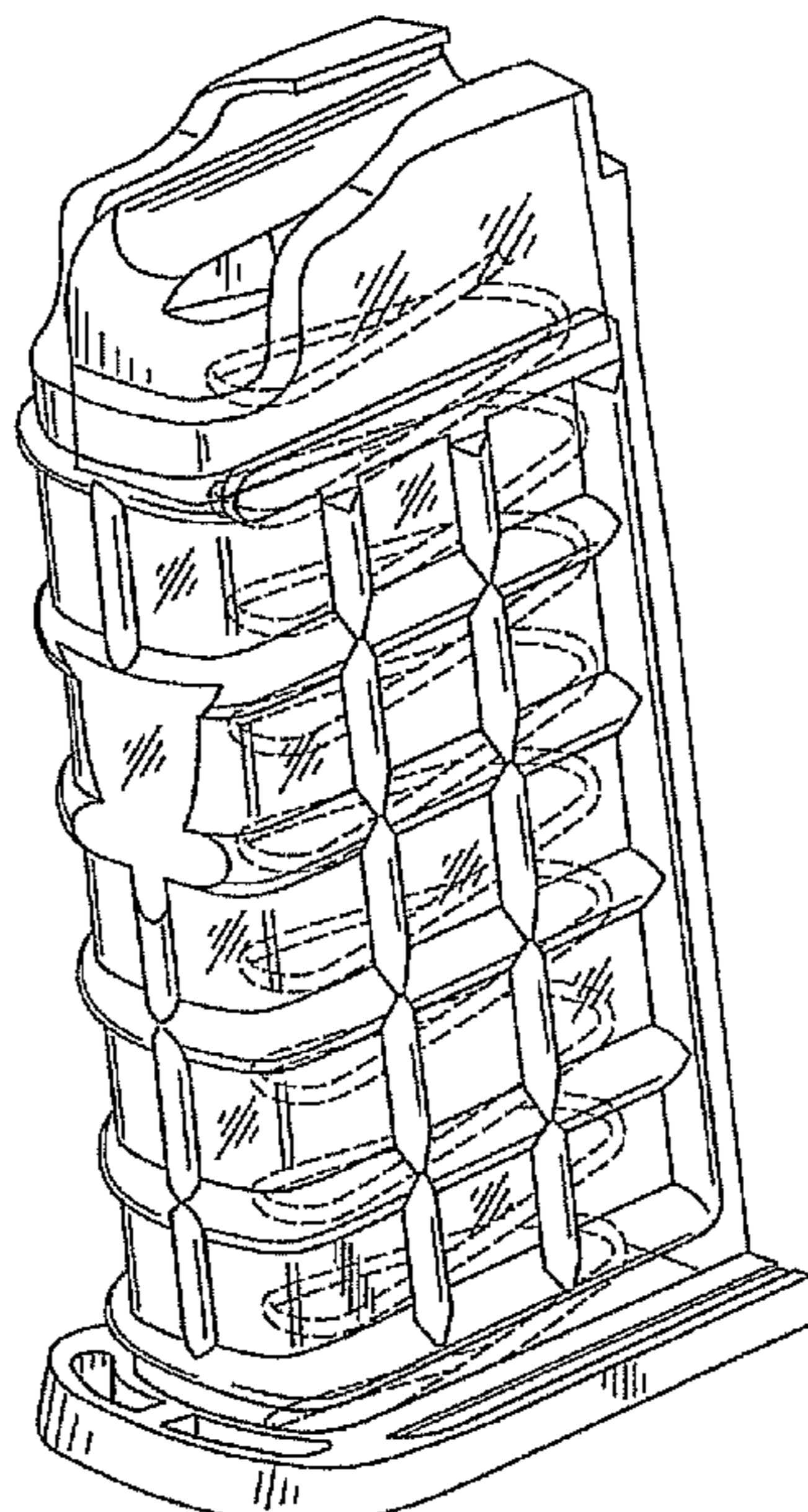

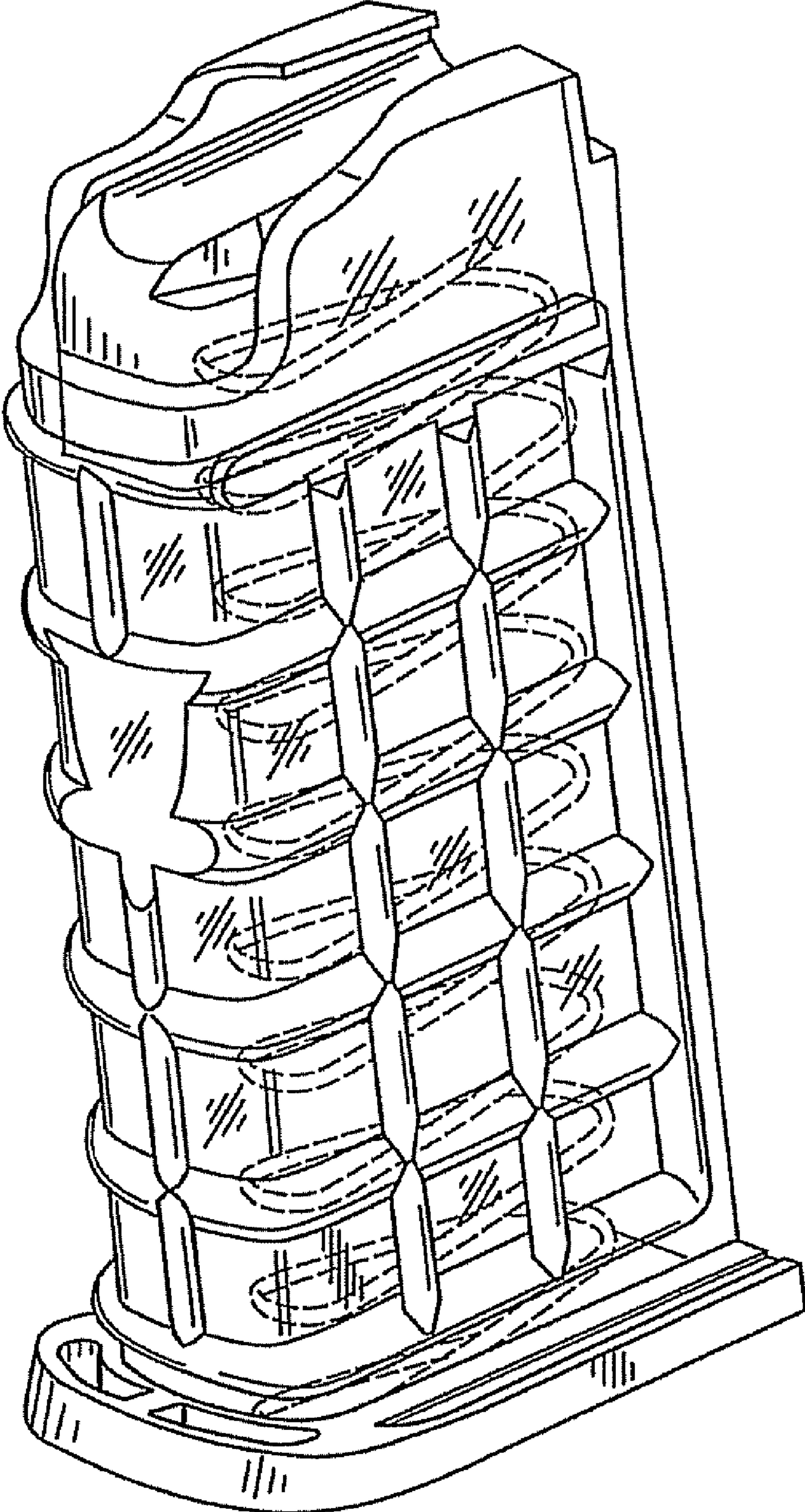

FIG. 1

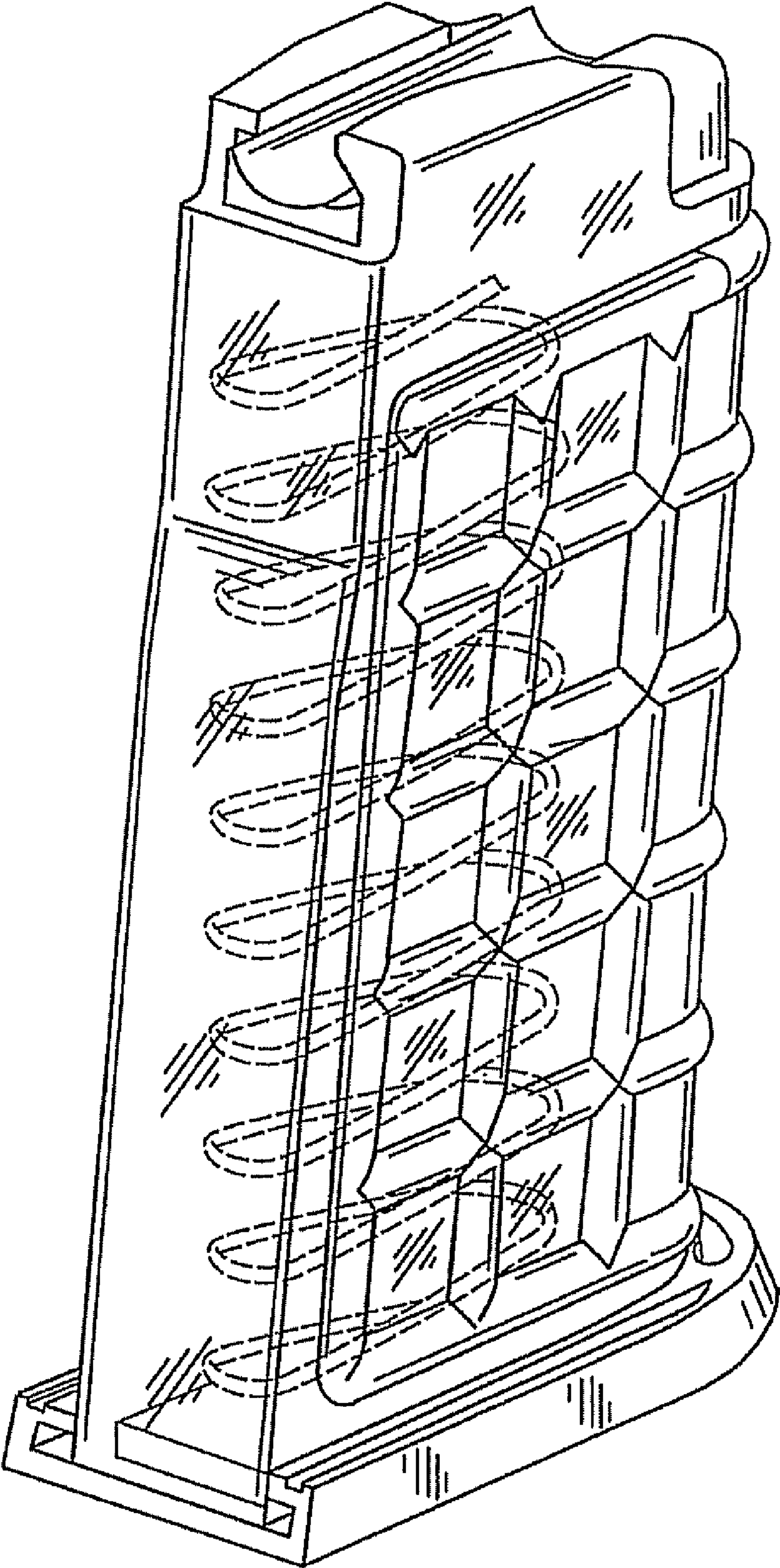

FIG. 2

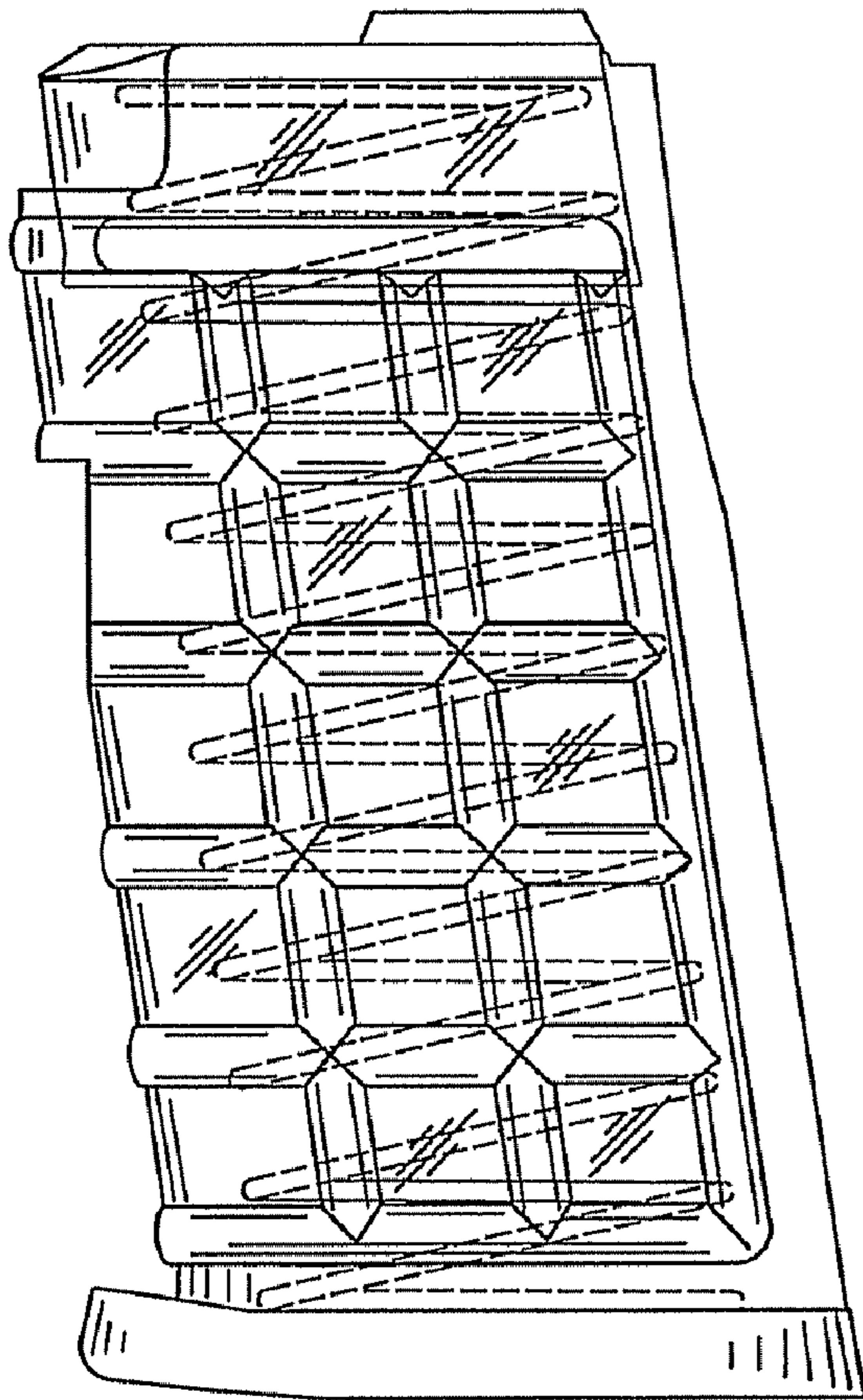

FIG. 3

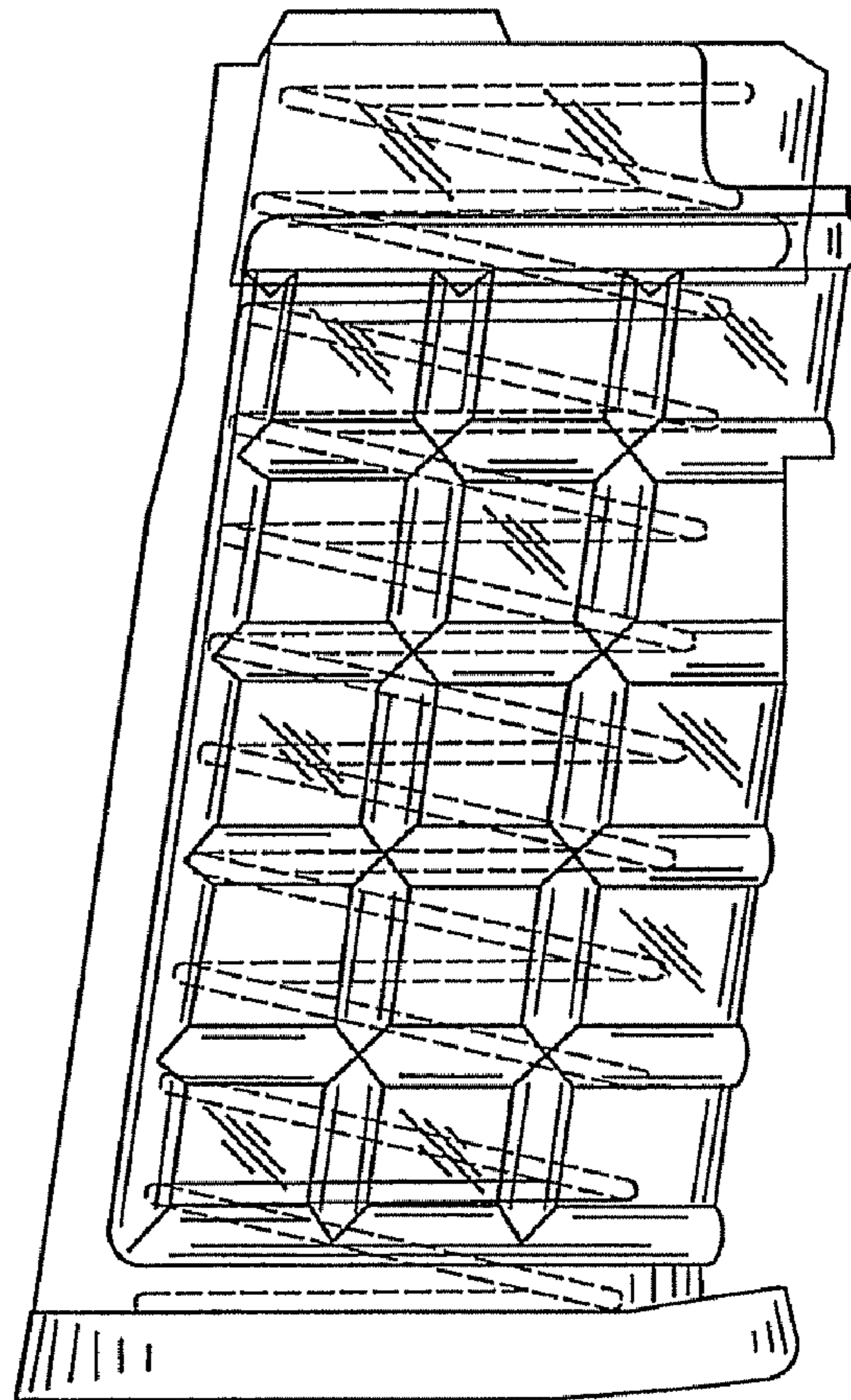

FIG. 4

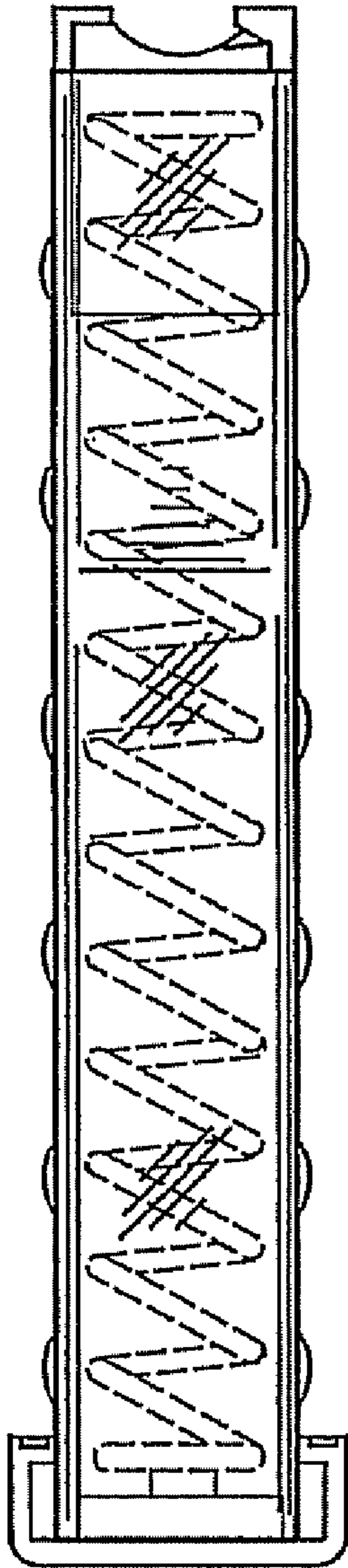

FIG. 5

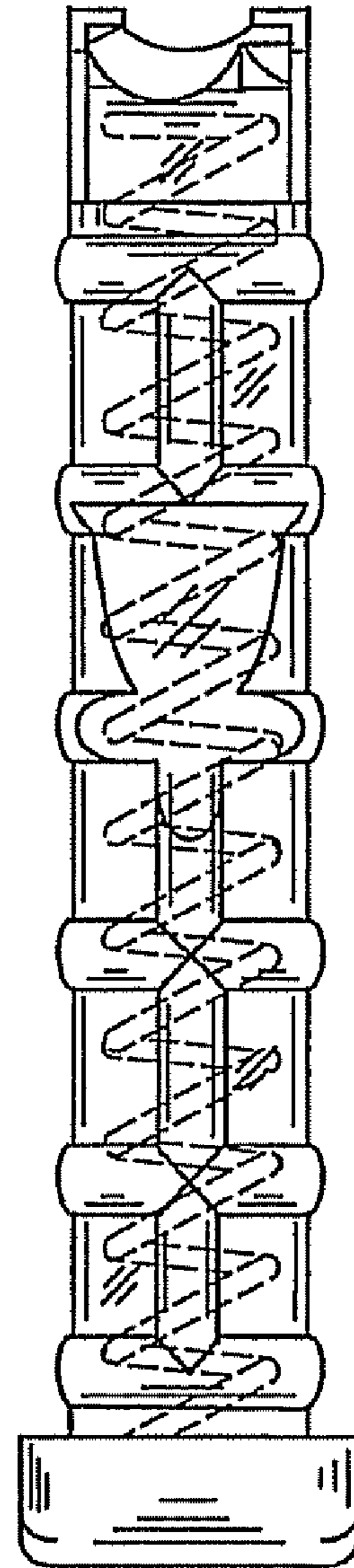

FIG. 6

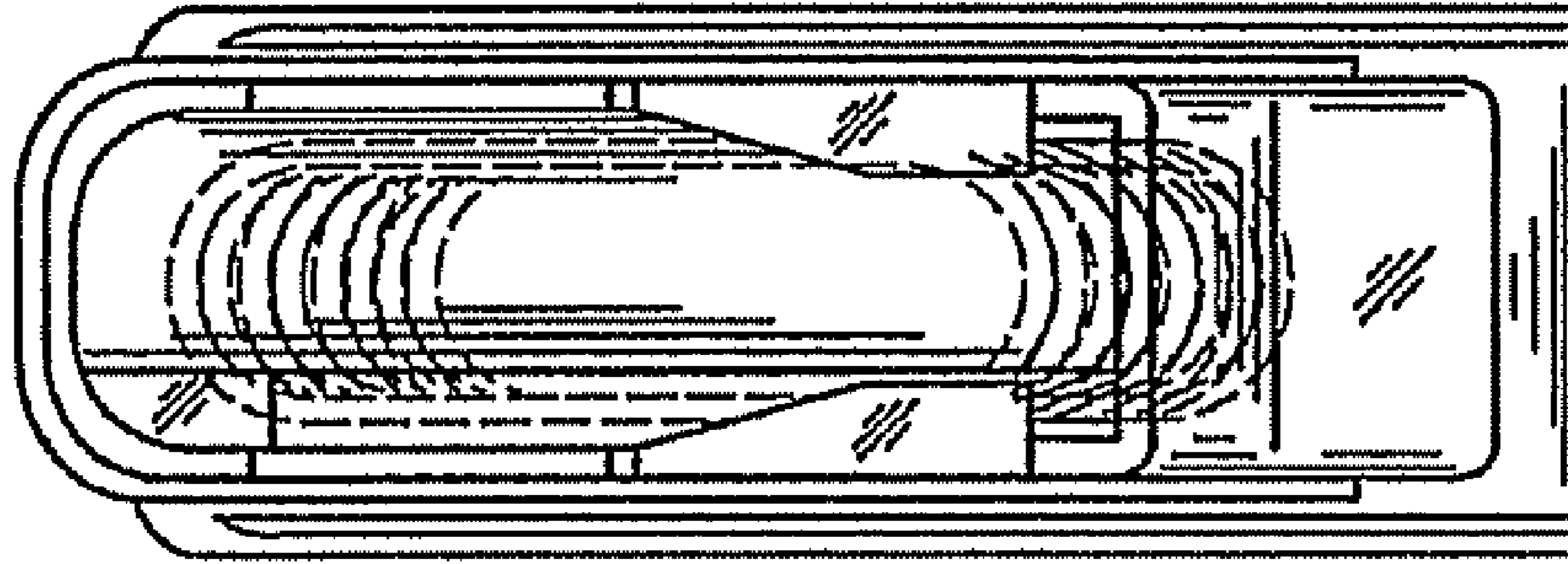

FIG. 7

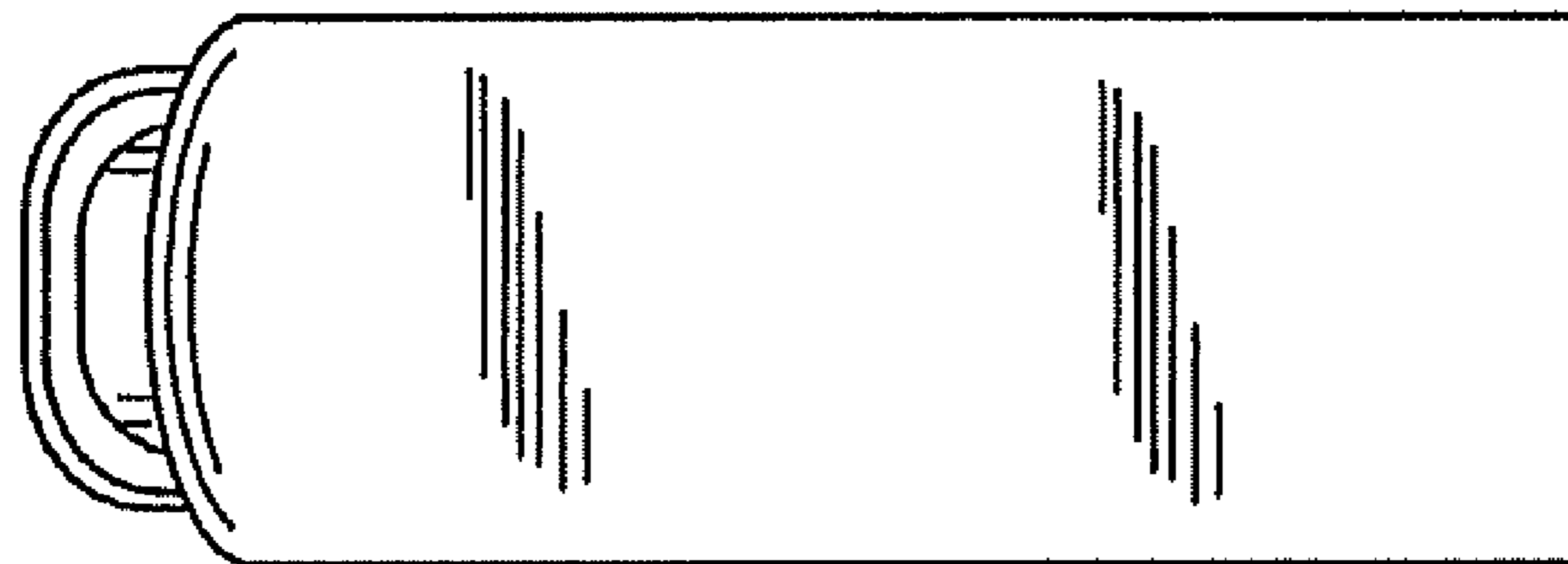

FIG. 8

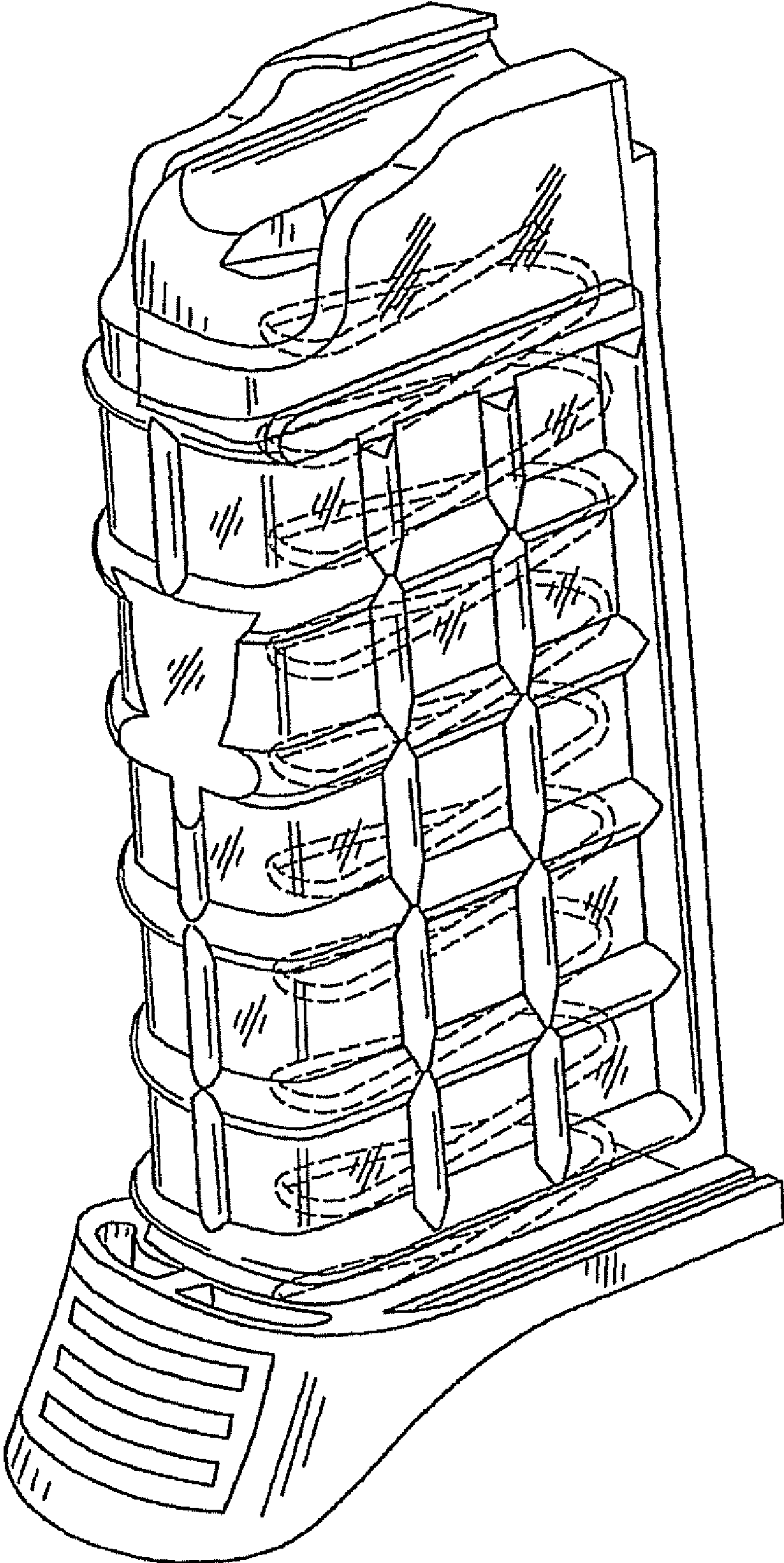

FIG. 9

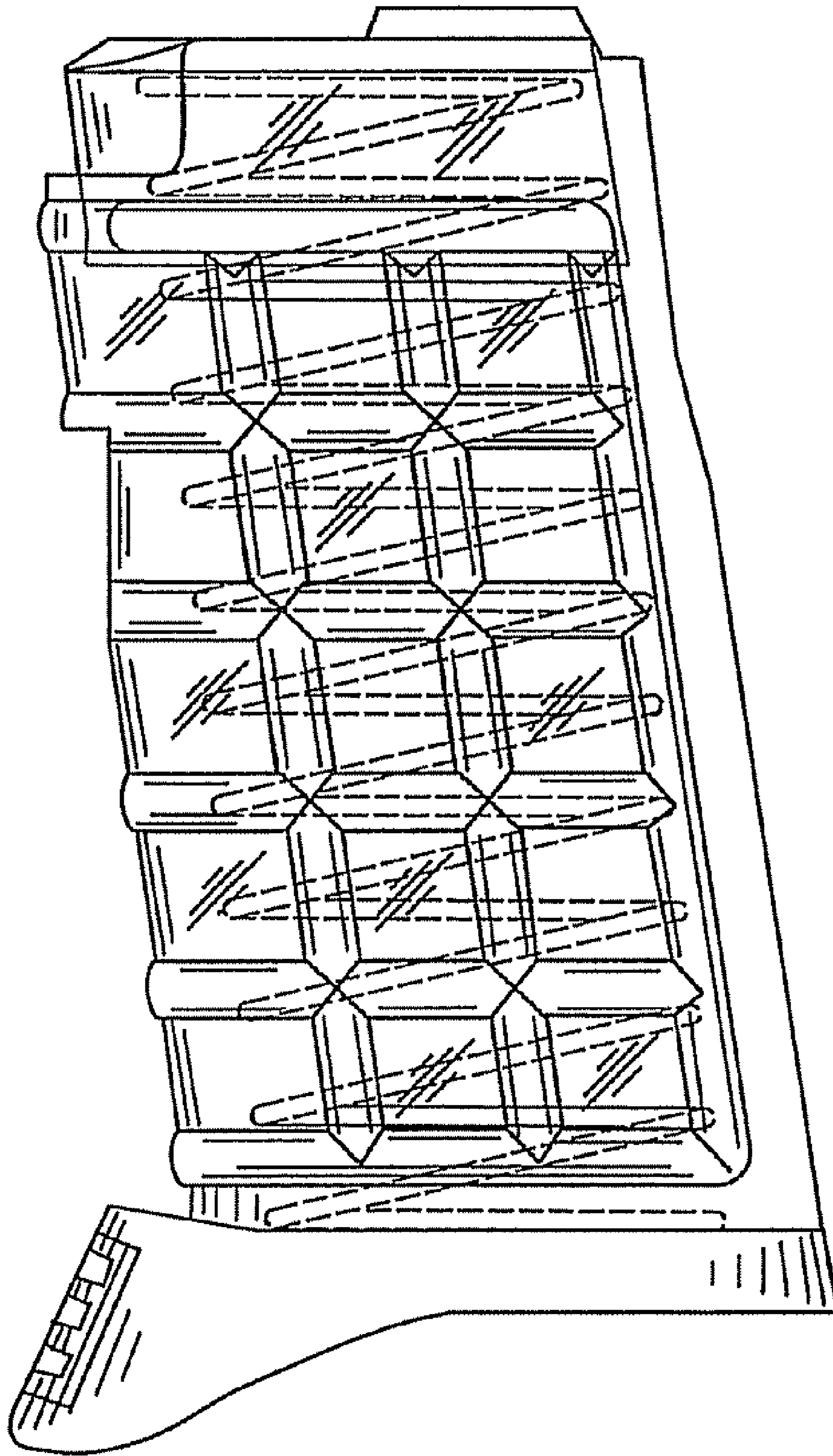

FIG. 10

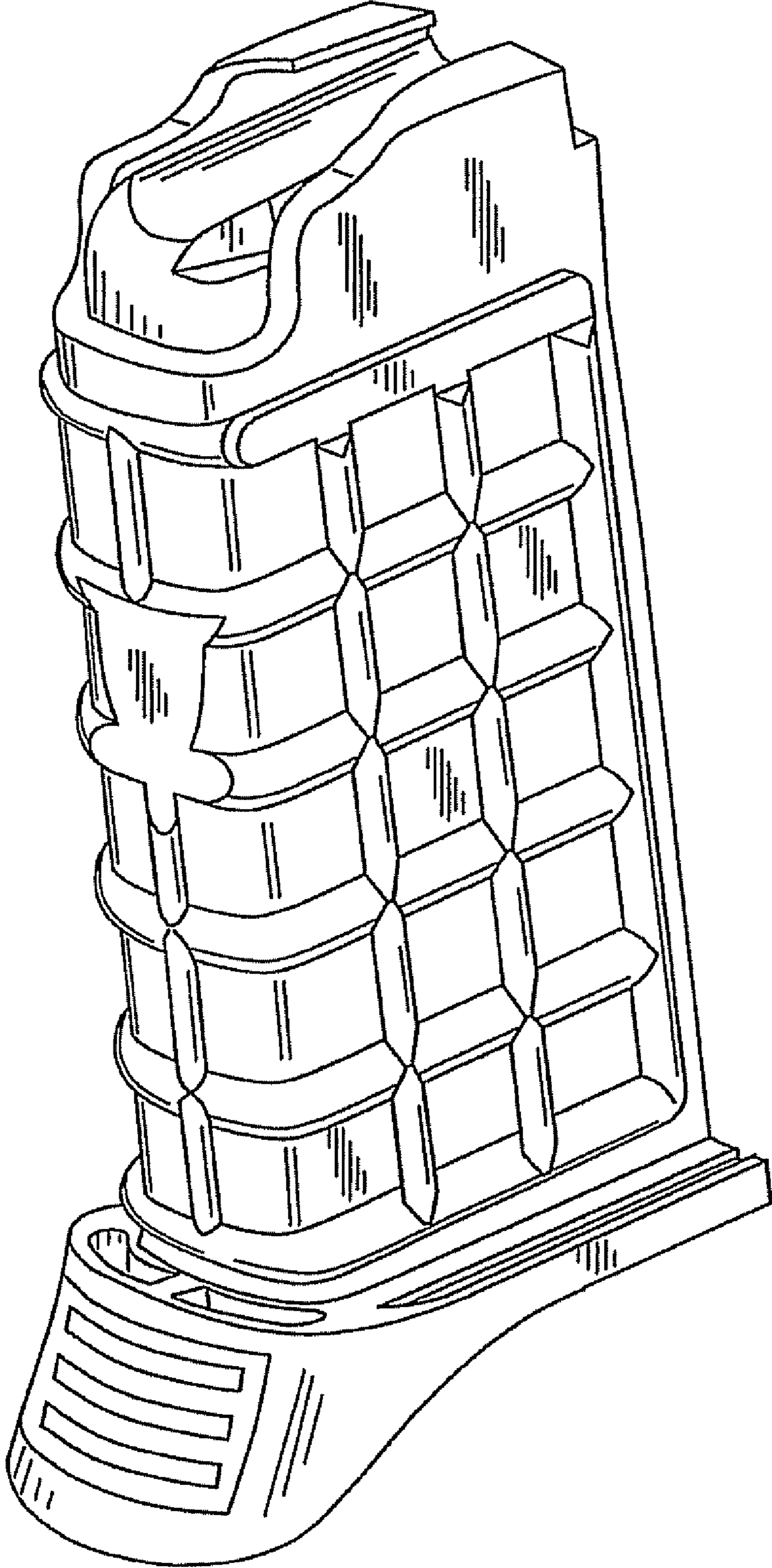

FIG. 11

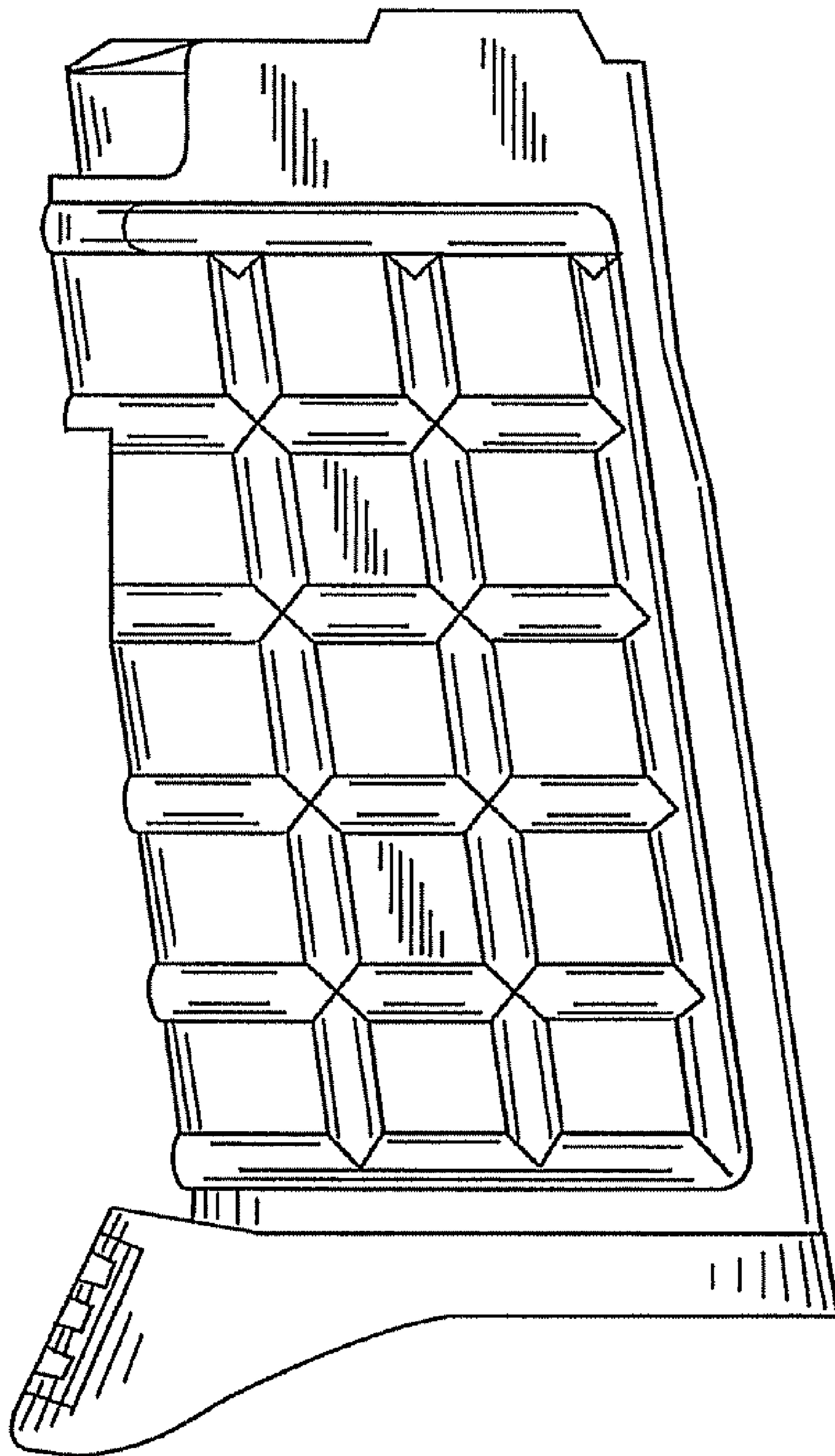

FIG. 12

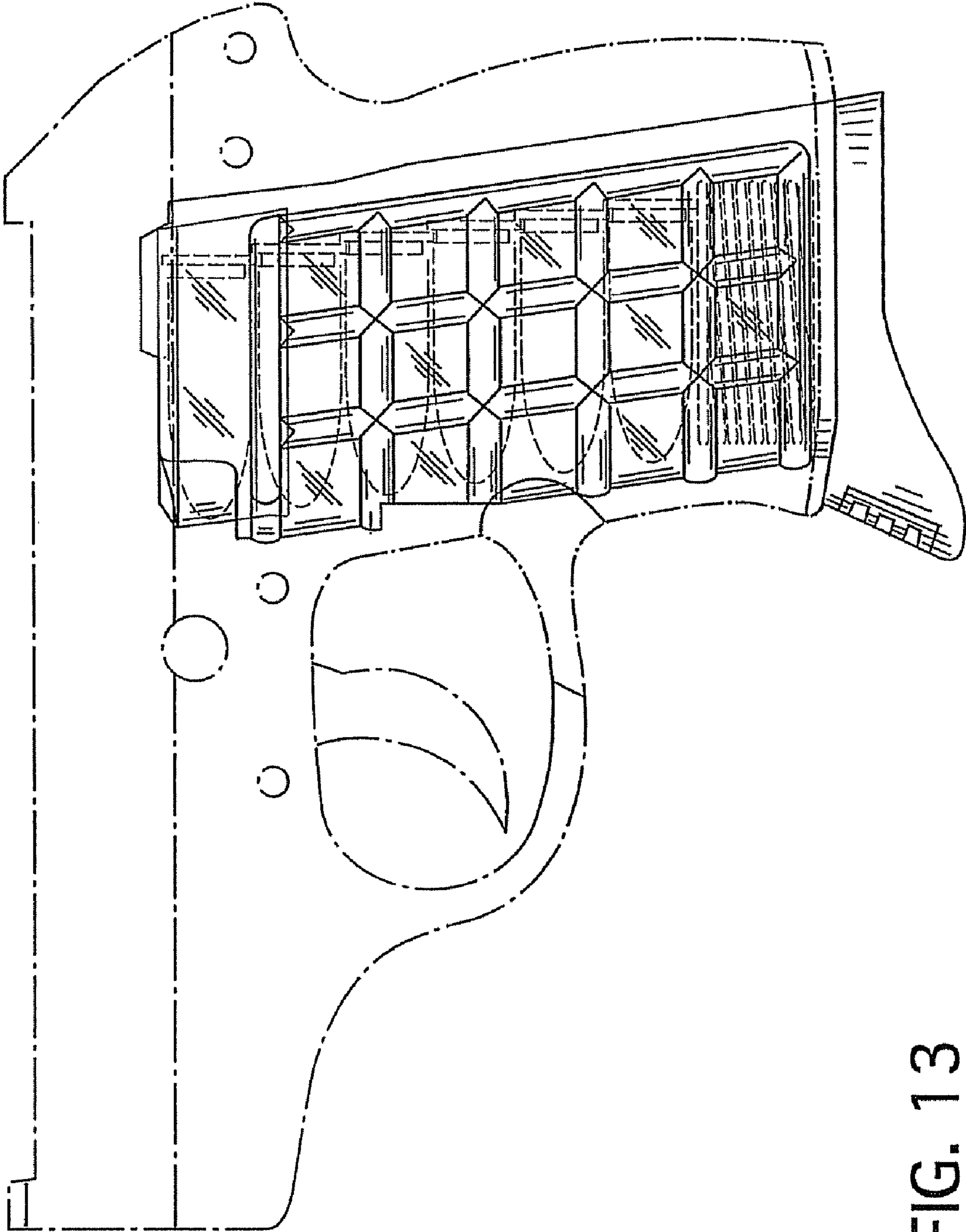

FIG. 13