



US00D642157S

(12) **United States Design Patent**
Holzer

(10) **Patent No.:** **US D642,157 S**

(45) **Date of Patent:** **** Jul. 26, 2011**

(54) **ILLUMINATED SPEAKER DOCK**

(75) Inventor: **Eric Holzer**, Piscataway, NJ (US)

(73) Assignee: **SDI Technologies, Inc.**, Rahway, NJ (US)

(**) Term: **14 Years**

(21) Appl. No.: **29/377,701**

(22) Filed: **Oct. 25, 2010**

(51) **LOC (9) Cl.** **14-01**

(52) **U.S. Cl.** **D14/209.1**

(58) **Field of Classification Search** D14/204,
D14/207, 209.1, 210–217, 168, 171, 172;
181/143–144, 147–148, 150–153, 157, 198–199;
381/300–303, 306, 332–333, 336, 345, 361–364,
381/386–388; D13/108

See application file for complete search history.

(56) **References Cited**

U.S. PATENT DOCUMENTS

D480,376 S * 10/2003 Ma D13/108
D482,020 S * 11/2003 Olson et al. D14/216
D510,926 S * 10/2005 Jerome D14/168

D541,260 S * 4/2007 Christianson D14/215
D554,108 S * 10/2007 Solland D14/217
D606,515 S * 12/2009 Ludlum et al. D14/209.1

* cited by examiner

Primary Examiner — Nanda Bondade

(74) *Attorney, Agent, or Firm* — Ostrolenk Faber LLP

(57) **CLAIM**

The ornamental design for an illuminated speaker dock, shown and described.

DESCRIPTION

FIG. 1 is a top, front, side, perspective view of an illuminated speaker dock showing my new design;

FIG. 2 is a front view thereof;

FIG. 3 is a rear view thereof;

FIG. 4 is a top view thereof;

FIG. 5 is a bottom view thereof;

FIG. 6 is a side view thereof, the opposite side view being a mirror image;

FIG. 7 is a cross-sectional view along line 7—7 in FIG. 4; and, FIG. 8 is a cross-sectional view along line 8—8 in FIG. 4.

The broken lines in the drawings illustrate environmental material that forms no part of the claimed design.

1 Claim, 8 Drawing Sheets

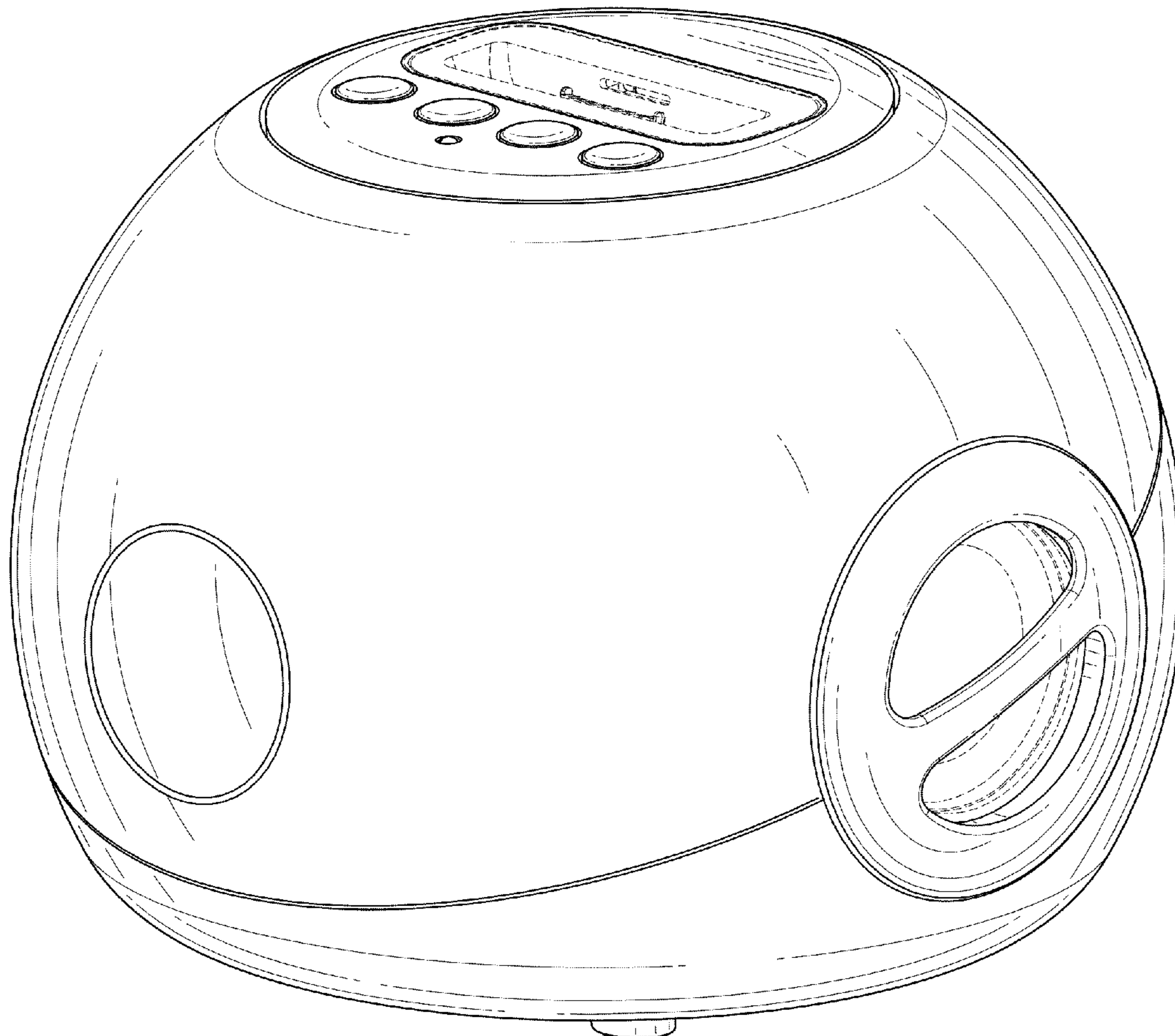

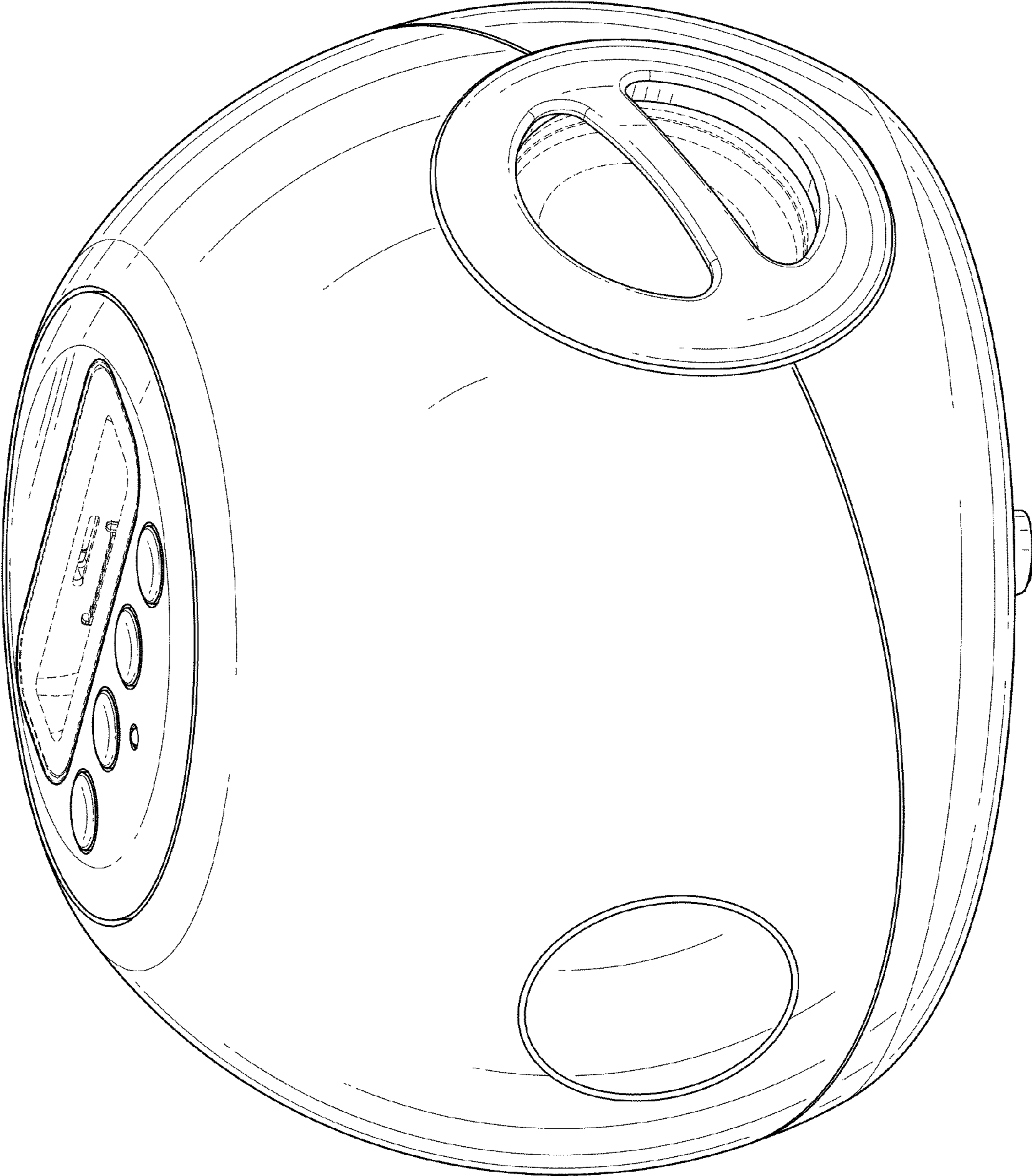

FIG.1

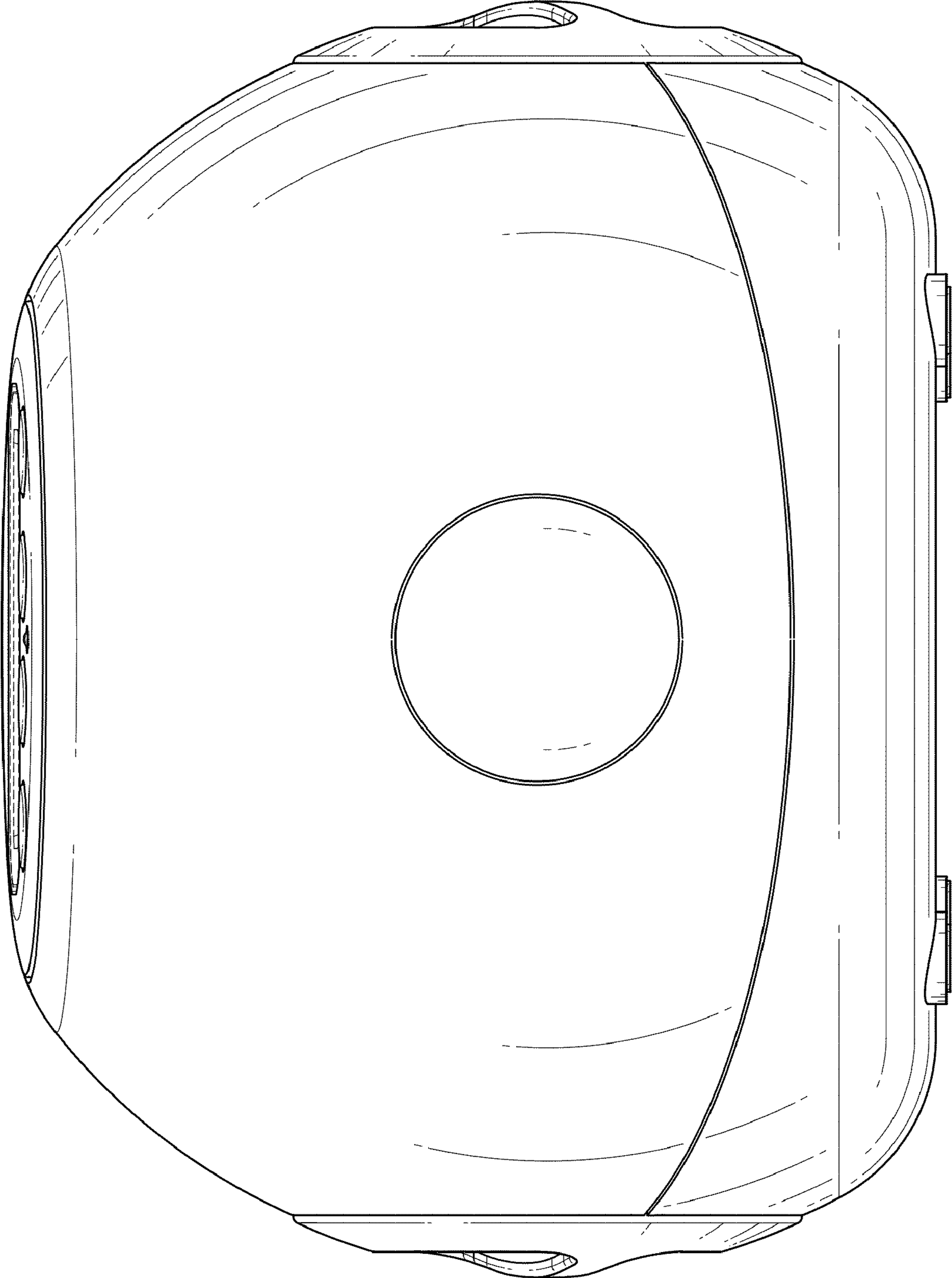

FIG. 2

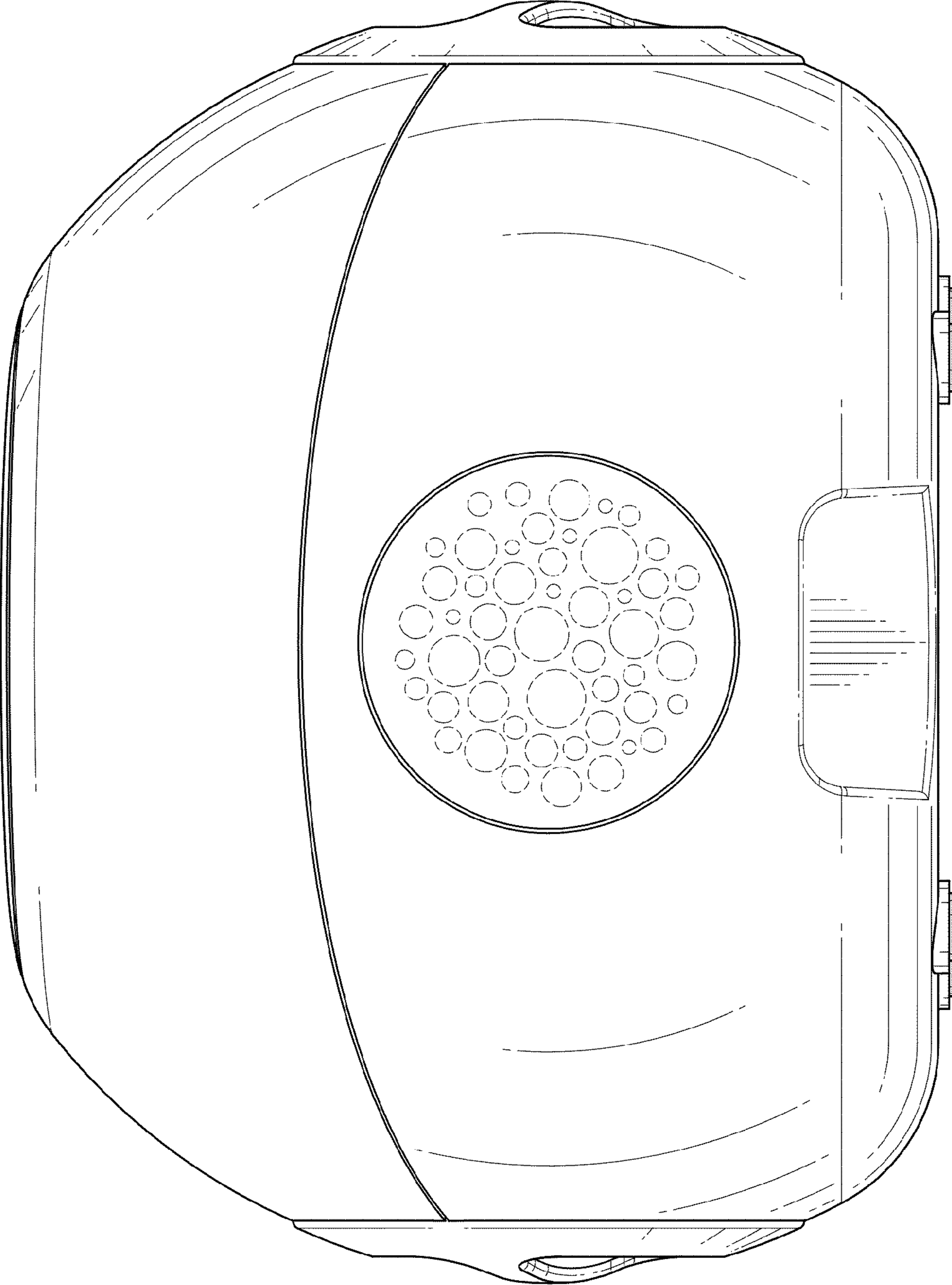

FIG. 3

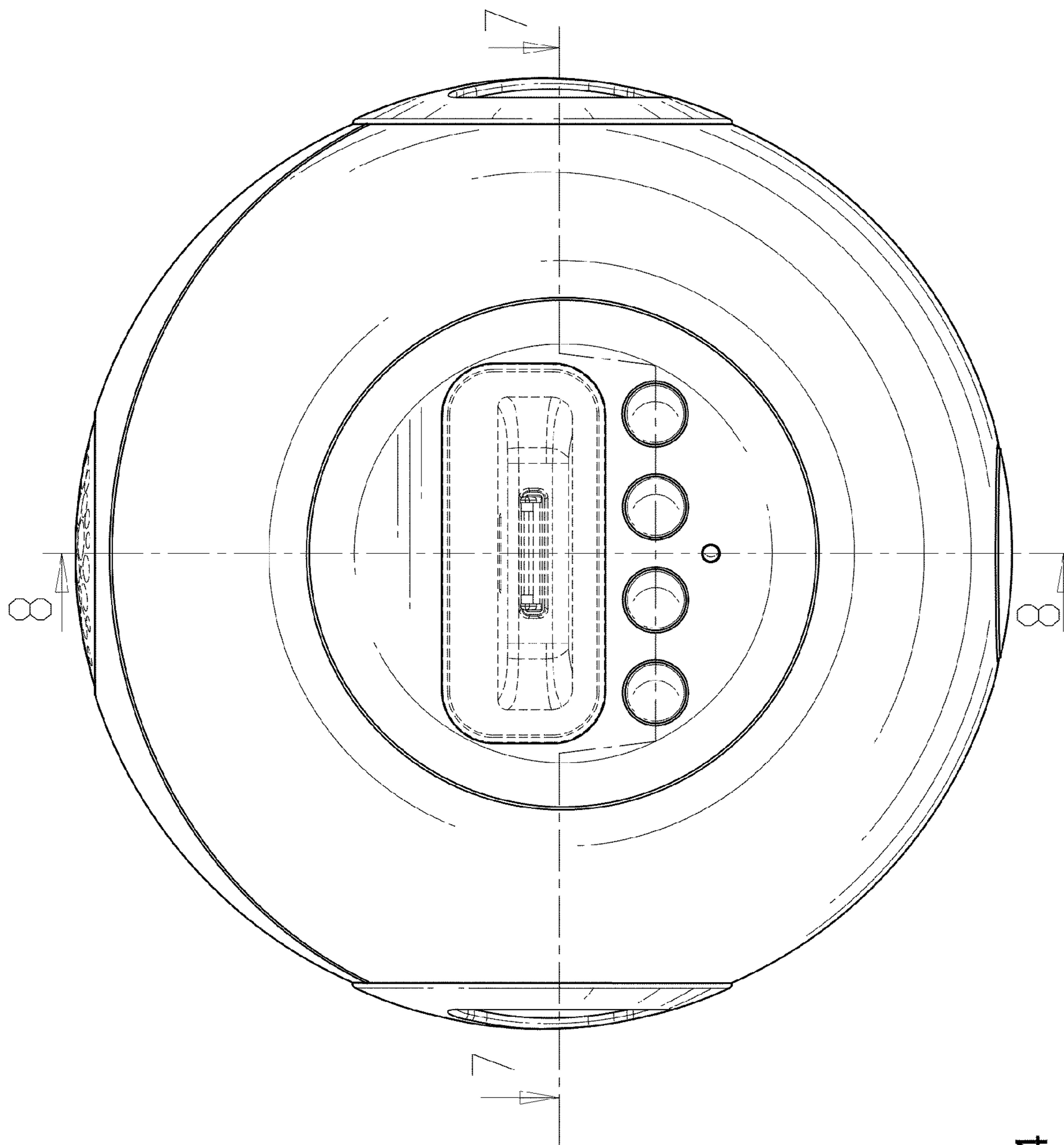

FIG. 4

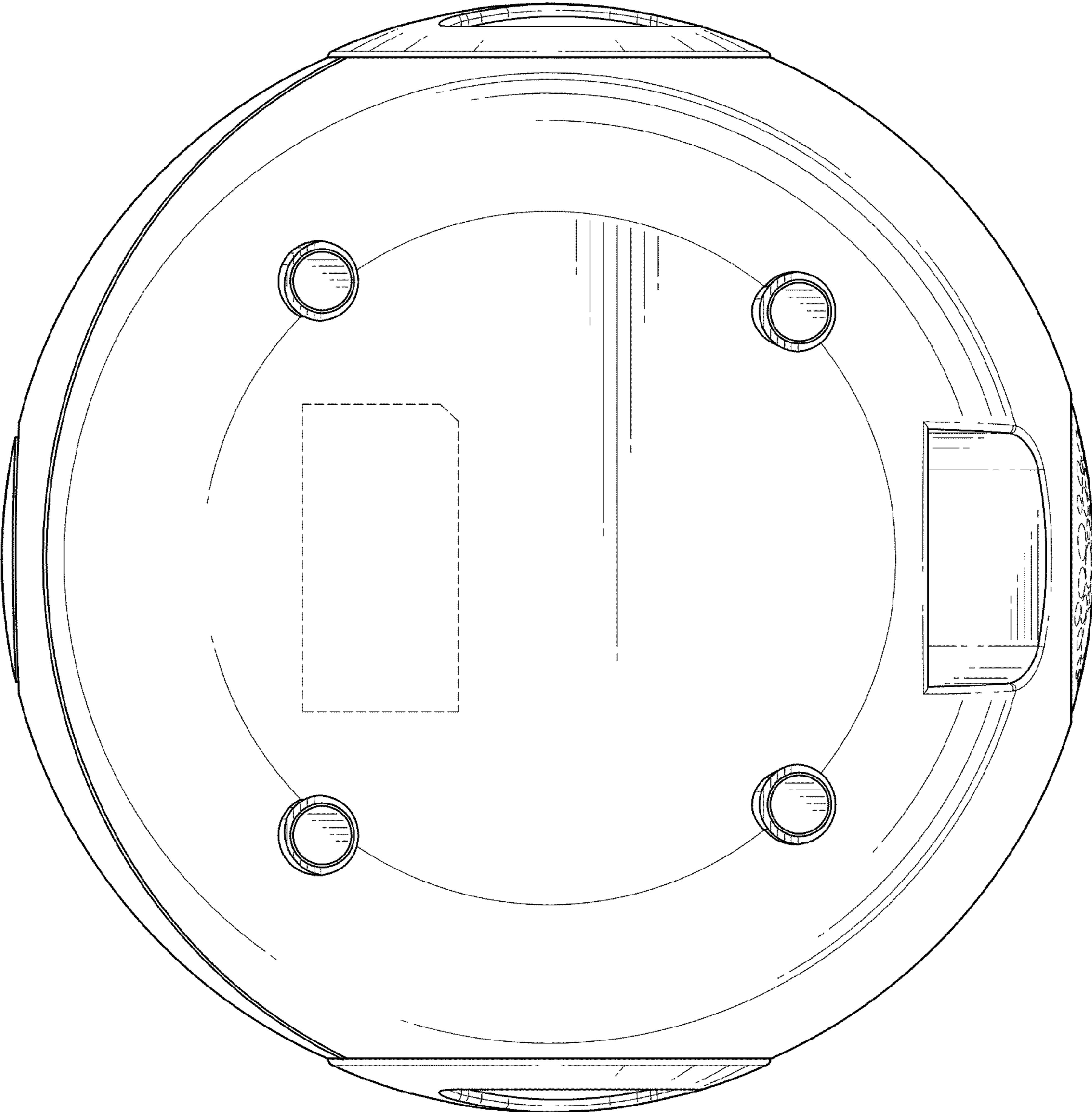

FIG. 5

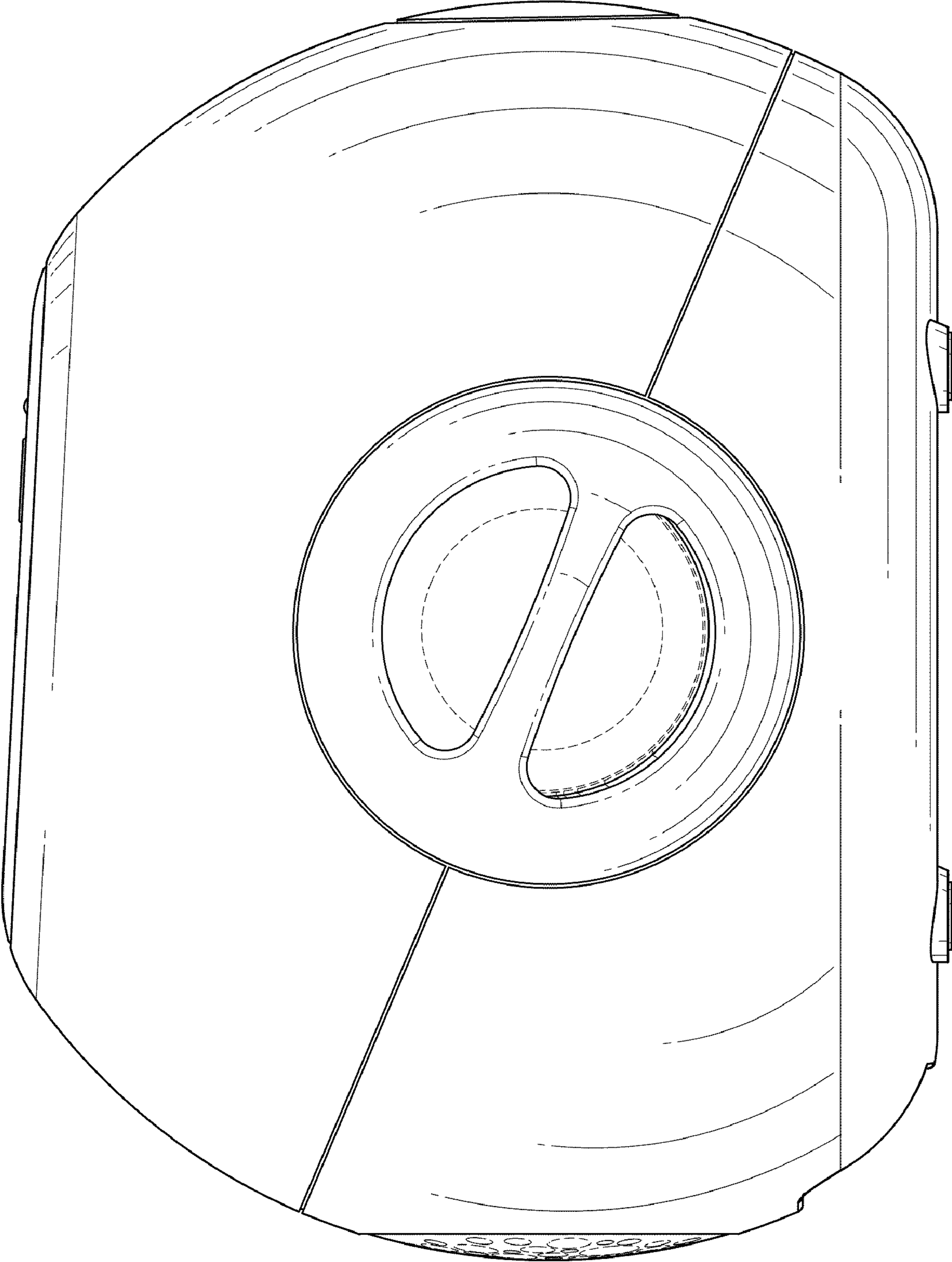

FIG. 6

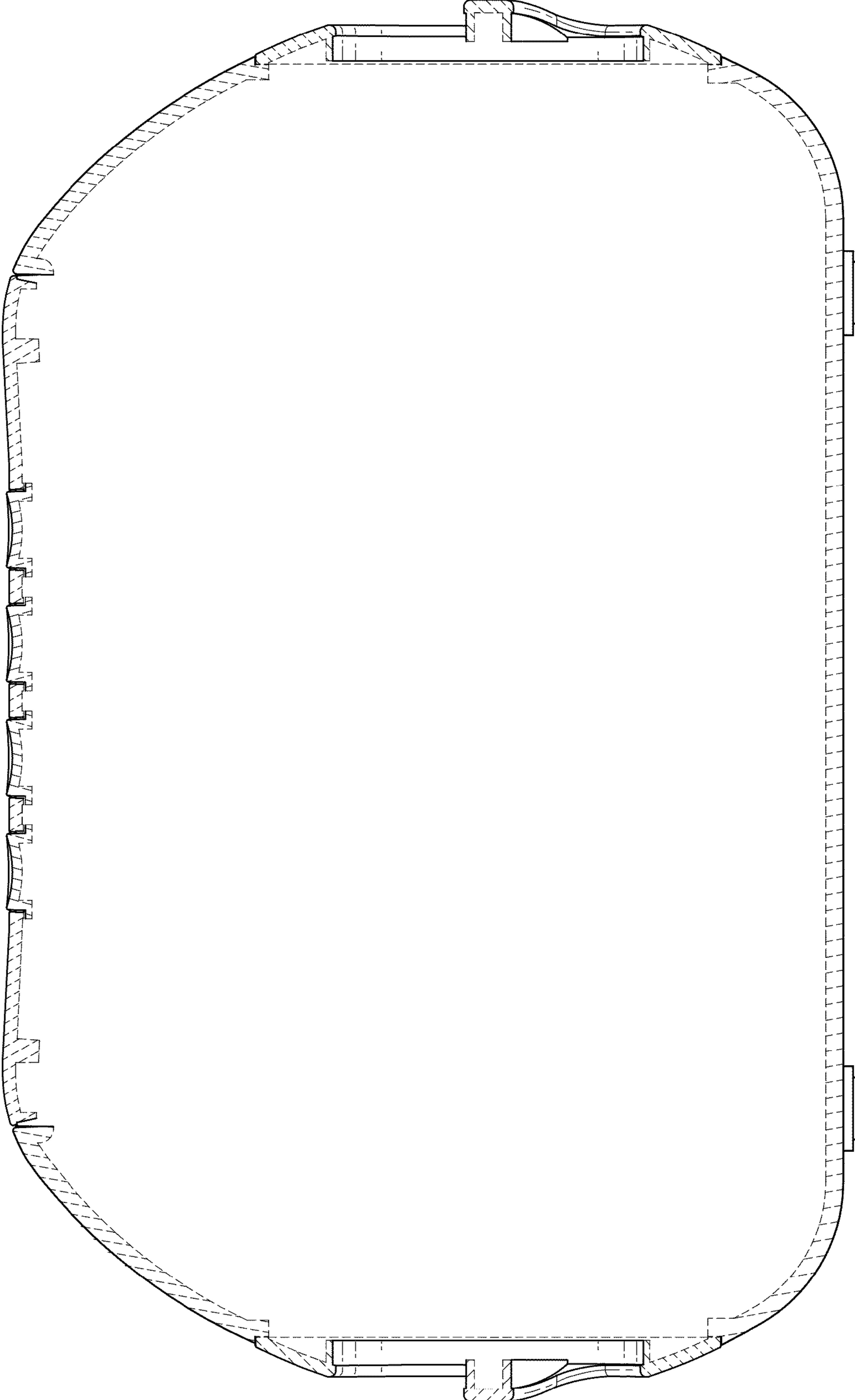

FIG.7

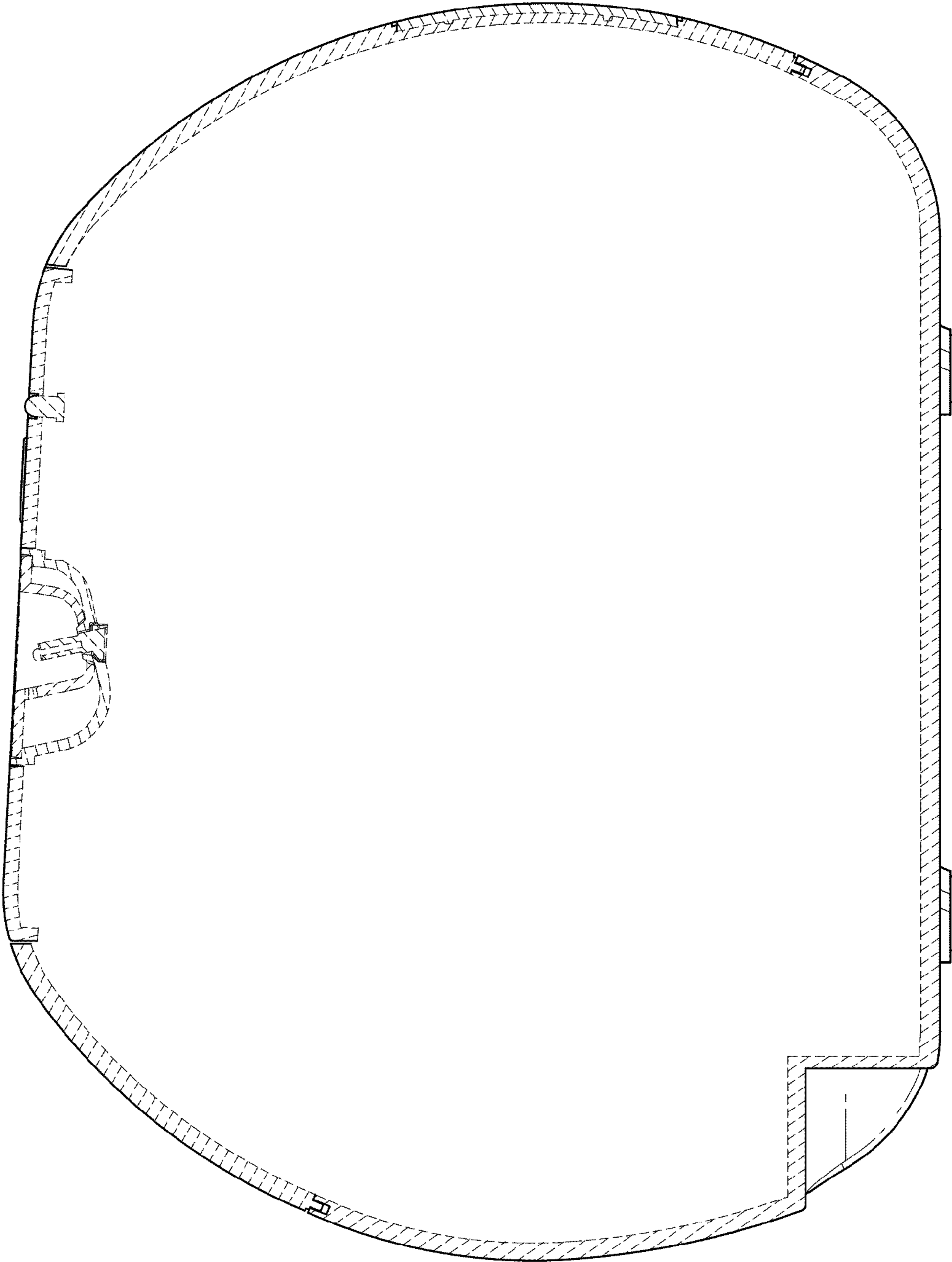

FIG. 8