



US00D642040S

(12) **United States Design Patent**
Romine

(10) **Patent No.:** **US D642,040 S**

(45) **Date of Patent:** **** Jul. 26, 2011**

(54) **LEVEL SUPPORT CLAMP**

(76) **Inventor:** **Barry Kent Romine**, Hampshire, TN
(US)

(**) **Term:** **14 Years**

(21) **Appl. No.:** **29/380,120**

(22) **Filed:** **Nov. 30, 2010**

(51) **LOC (9) Cl.** **08-05**

(52) **U.S. Cl.** **D8/72**

(58) **Field of Classification Search** D8/71-74,
D8/394, 395, 397-399, 354, 355, 59; 248/229.16,
248/62, 63, 72, 74.1, 689, 124.2, 65; 33/372,
33/347, 370; 24/555, 563, 133; 269/3, 4,
269/6, 143, 165, 240, 243, 246-249, 254 R,
269/147-149; 29/256, 257, 276; D15/140;
D24/143; 408/103, 104-109; 81/487; D6/400
See application file for complete search history.

5,749,151 A	5/1998	Scott et al.	
5,799,404 A	9/1998	Payne	
5,819,425 A	10/1998	Payne	
D516,904 S *	3/2006	Kendrick	D8/395
7,059,059 B1	6/2006	Ames	
D535,743 S *	1/2007	Williams	D24/133
7,243,431 B2	7/2007	Godwin	
D570,198 S *	6/2008	Mamula	D8/354
7,562,462 B2	7/2009	Gentleman et al.	
D608,631 S *	1/2010	Preminger	D8/395
D611,513 S *	3/2010	Coburn	D15/140

* cited by examiner

Primary Examiner — David Muller

(74) *Attorney, Agent, or Firm* — Dowell & Dowell, PC

(57) **CLAIM**

The ornamental design for a level support clamp, as shown and described.

DESCRIPTION

FIG. 1 is a front perspective view of a level support clamp showing my new design;
FIG. 2 is a front elevational view thereof;
FIG. 3 is a left side view thereof, a view from the right side being a mirror image;
FIG. 4 is a top plan view thereof;
FIG. 5 is a bottom plan view thereof; and,
FIG. 6 is an illustrational view thereof in use.
The broken line showing of parts of the drawings is included for the purpose of illustrating use and environment and forms no part of the claimed design.

1 Claim, 4 Drawing Sheets

(56) **References Cited**

U.S. PATENT DOCUMENTS

1,200,410 A	10/1916	Chemrinsky	
1,229,916 A	6/1917	Duncan	
2,600,980 A *	6/1952	Eyre	24/563
D276,272 S *	11/1984	Weissenburger	D8/394
D299,112 S *	12/1988	Downey	D8/354
D306,136 S *	2/1990	Lund	D8/395
D306,553 S *	3/1990	Rumpel	D8/395
D309,255 S *	7/1990	Karow, Jr.	D8/395
5,408,752 A	4/1995	Eadens	
D364,799 S *	12/1995	Callas	D8/395
5,581,900 A	12/1996	Payne	
5,666,702 A *	9/1997	Ming-Chieh	24/563

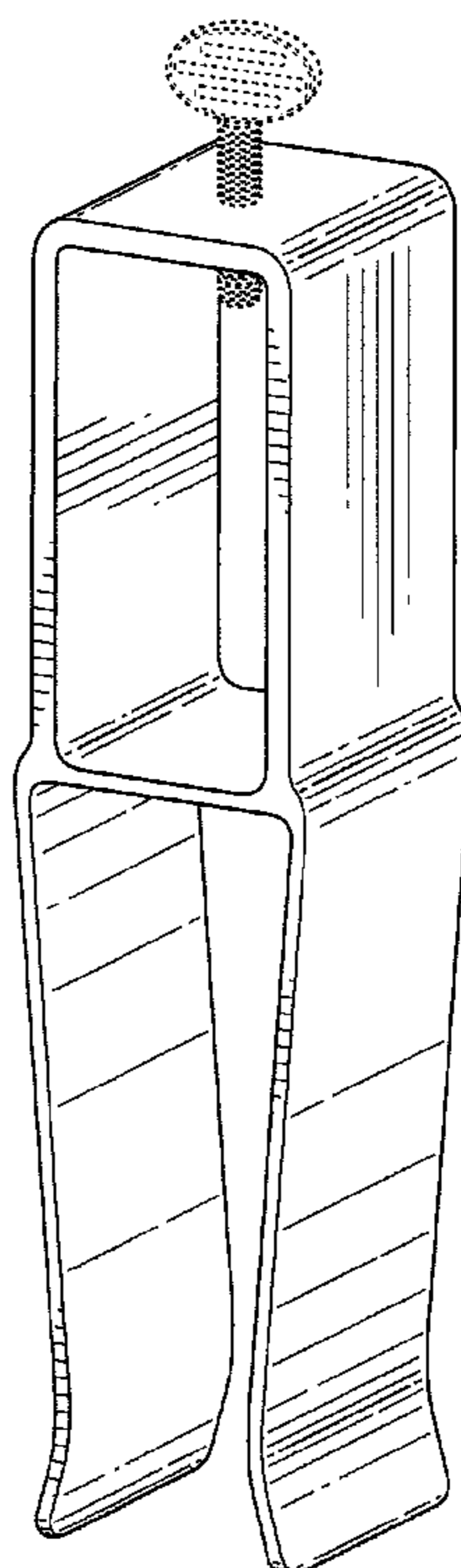

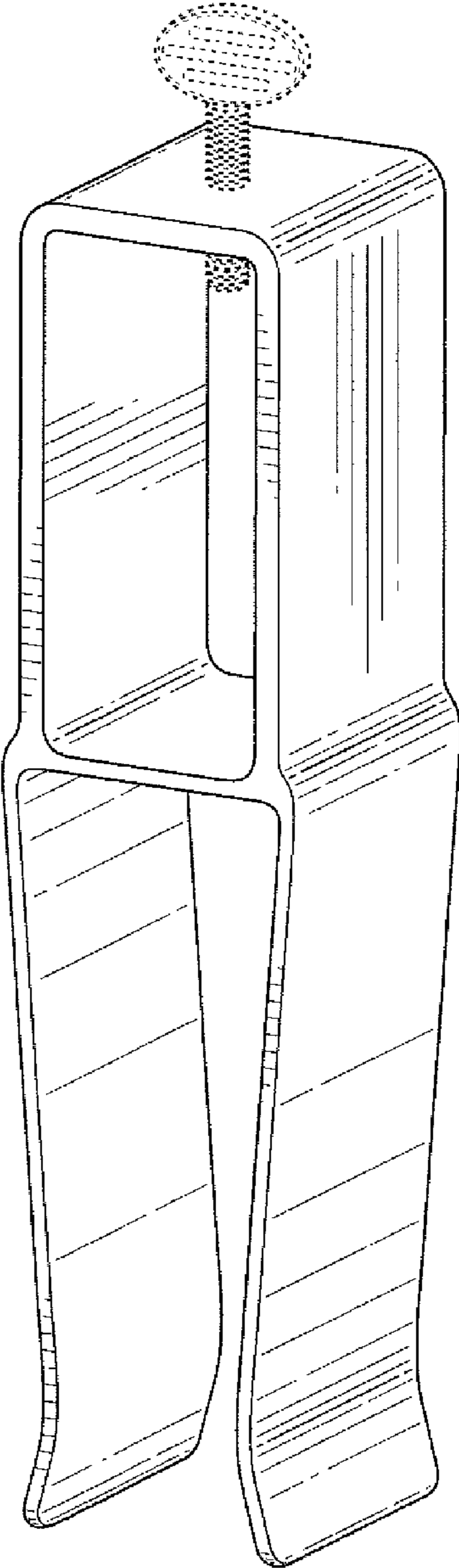

FIG. 1

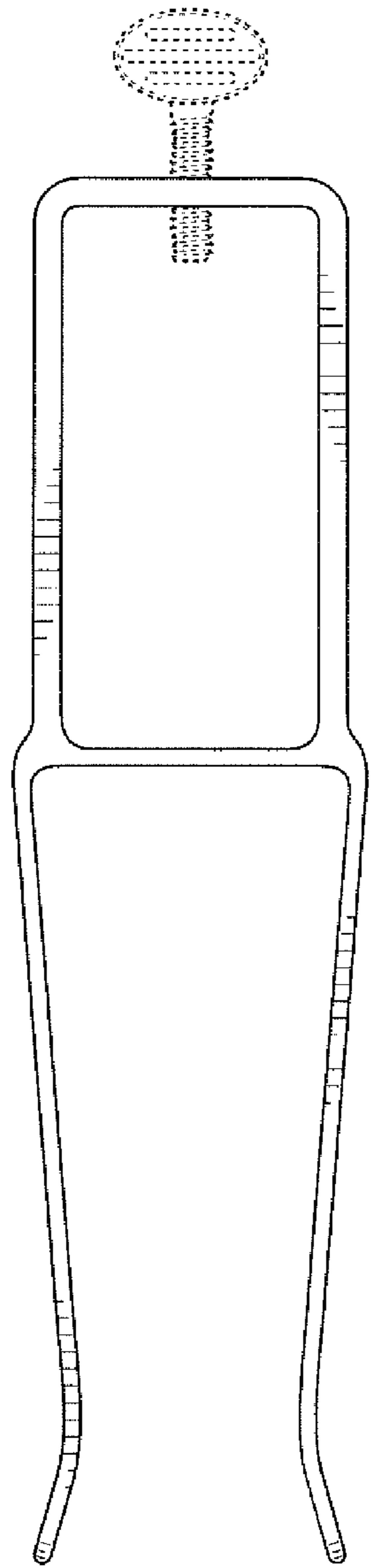

FIG. 2

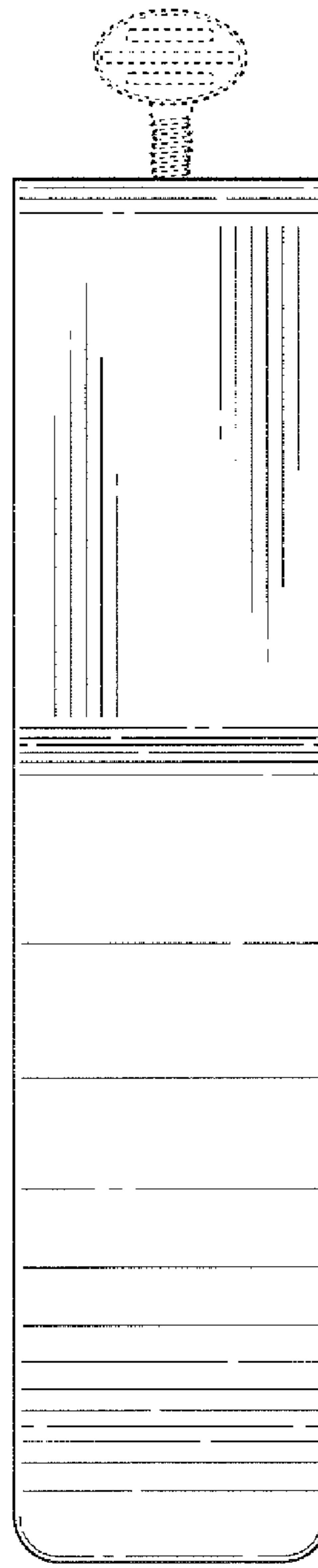

FIG. 3

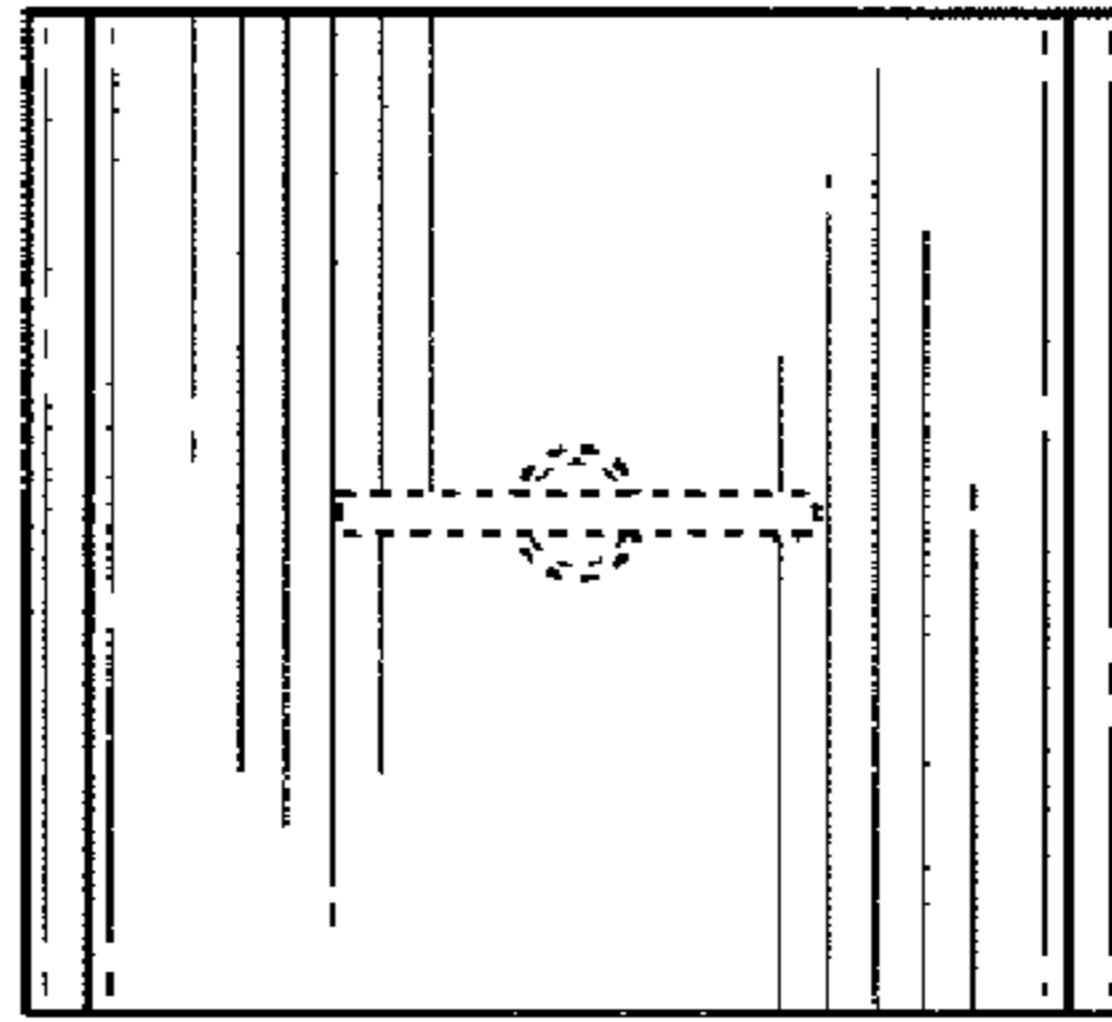

FIG. 4

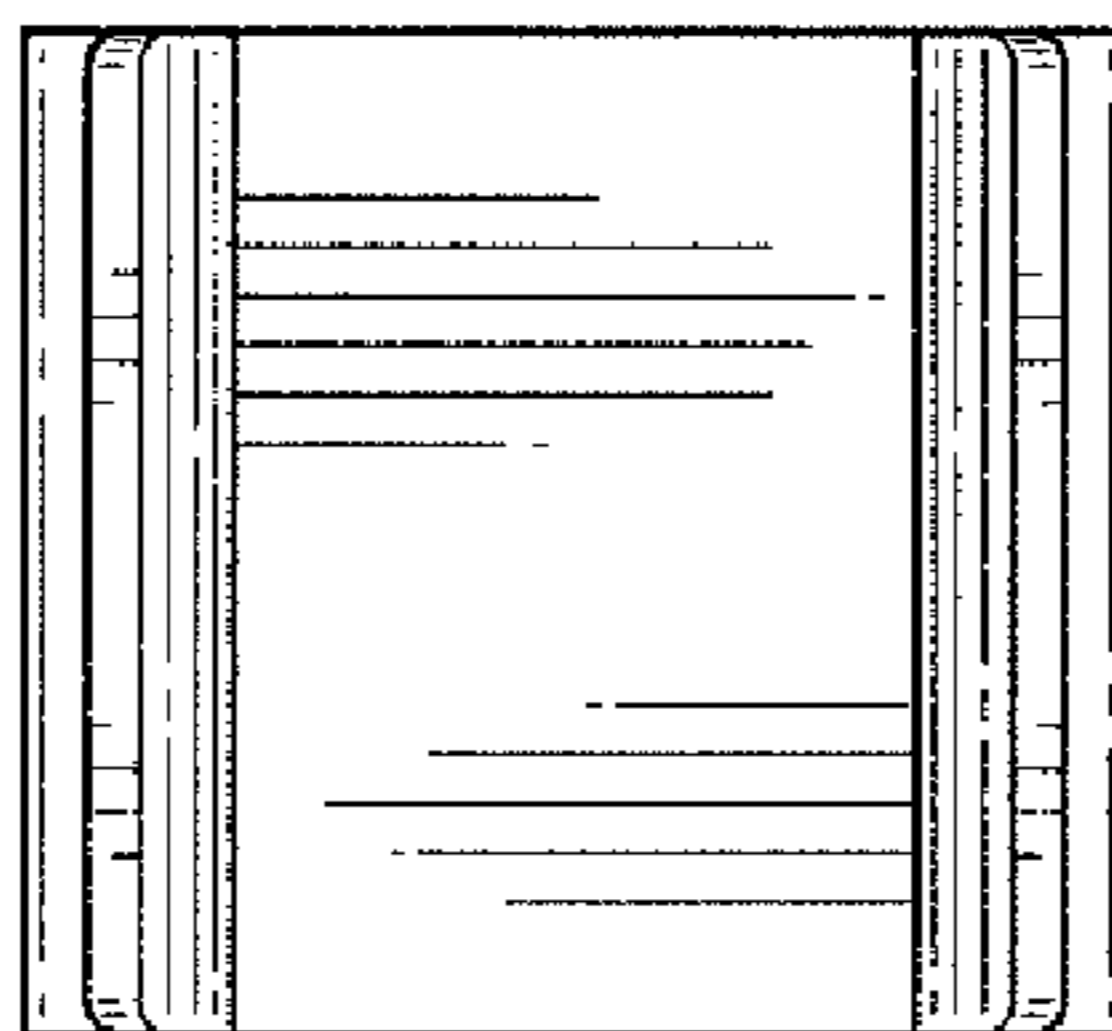

FIG. 5

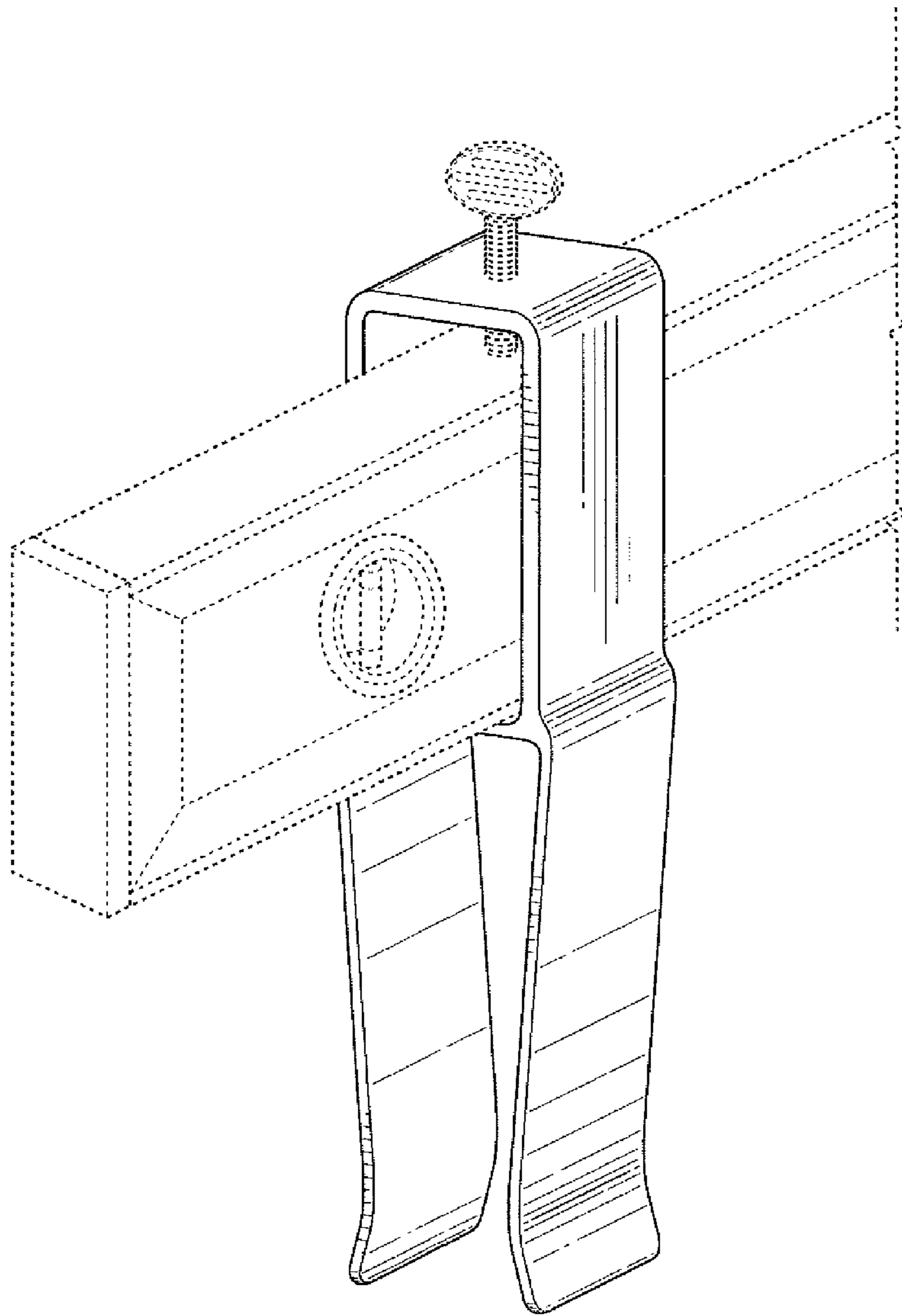

FIG. 6