



US00D641897S

(12) **United States Design Patent**
Weiser

(10) **Patent No.:** **US D641,897 S**

(45) **Date of Patent:** **** Jul. 19, 2011**

(54) **ULTRASONIC PEST REPELLER NIGHT LIGHT WITH WINDOWED HOUSING**

(75) Inventor: **Margaret Weiser**, Chatsworth, CA (US)

(73) Assignee: **Exhart Environmental Systems, Inc.**, Chatsworth, CA (US)

(**) Term: **14 Years**

(21) Appl. No.: **29/376,696**

(22) Filed: **Oct. 11, 2010**

(51) **LOC (9) Cl.** **26-05**

(52) **U.S. Cl.** **D26/26; D22/120**

(58) **Field of Classification Search** D26/26,
D26/24, 37, 38, 57, 73, 94, 98, 101; D10/110,
D10/114; D22/120, 122, 123; D21/315,
D21/318, 650, 712, 713, 780, 788; D11/119,
D11/137, 139, 144, 162; 362/640, 641, 642,
362/643, 644, 652, 653, 657, 658, 659, 563,
362/567, 122, 124, 183, 805, 806

See application file for complete search history.

(56) **References Cited**

U.S. PATENT DOCUMENTS

D326,923 S *	6/1992	Yuen	D26/26
D359,346 S *	6/1995	Martin	D23/366
D411,001 S *	6/1999	Pinchuk	D23/364
D433,521 S *	11/2000	Jaworski	D26/26
D441,468 S *	5/2001	Bing	D26/26
D458,334 S *	6/2002	Levine	D22/120

D468,033 S *	12/2002	Warren et al.	D26/26
D528,184 S *	9/2006	Yuen	D22/120
D535,734 S *	1/2007	Caserta et al.	D23/366
D610,666 S *	2/2010	Furner et al.	D23/366
2010/0033990 A1 *	2/2010	Chien	362/641

* cited by examiner

Primary Examiner — Angela Lee

(74) *Attorney, Agent, or Firm* — Cisló & Thomas, LLP

(57) **CLAIM**

The ornamental design for a ultrasonic pest repeller night light with windowed housing, as shown and described.

DESCRIPTION

FIG. 1 is a perspective view of the ultrasonic pest repeller night light with windowed housing.

FIG. 2 is a front view of the ultrasonic pest repeller night light with windowed housing.

FIG. 3 is a rear view of the ultrasonic pest repeller night light with windowed housing.

FIG. 4 is a right side view of the ultrasonic pest repeller night light with windowed housing.

FIG. 5 is a left side view of the ultrasonic pest repeller night light with windowed housing.

FIG. 6 is a top view of the ultrasonic pest repeller night light with windowed housing; and,

FIG. 7 is a bottom view of the ultrasonic pest repeller night light with windowed housing.

The portions of the night light shown in broken lines form no part of the claimed design.

1 Claim, 3 Drawing Sheets

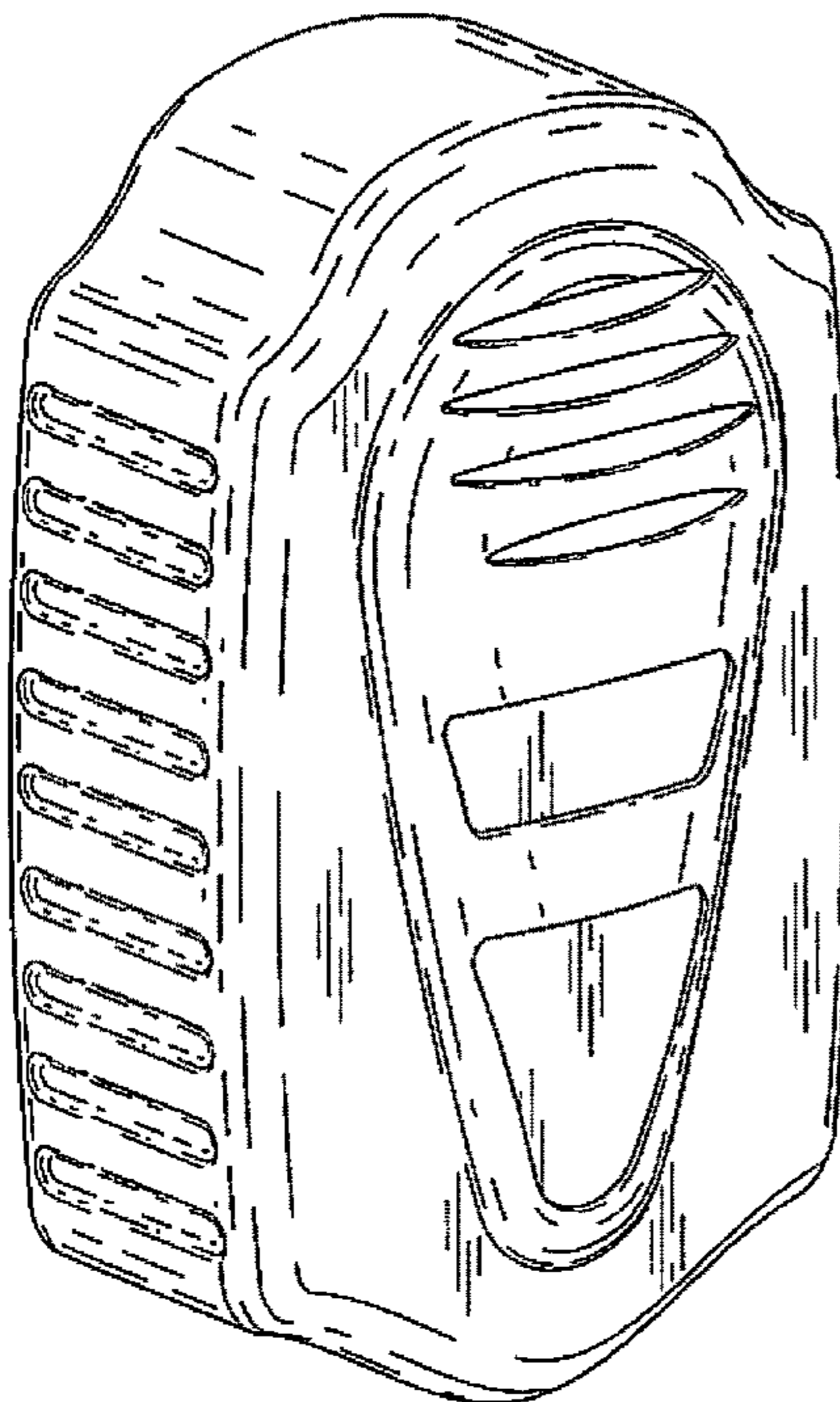

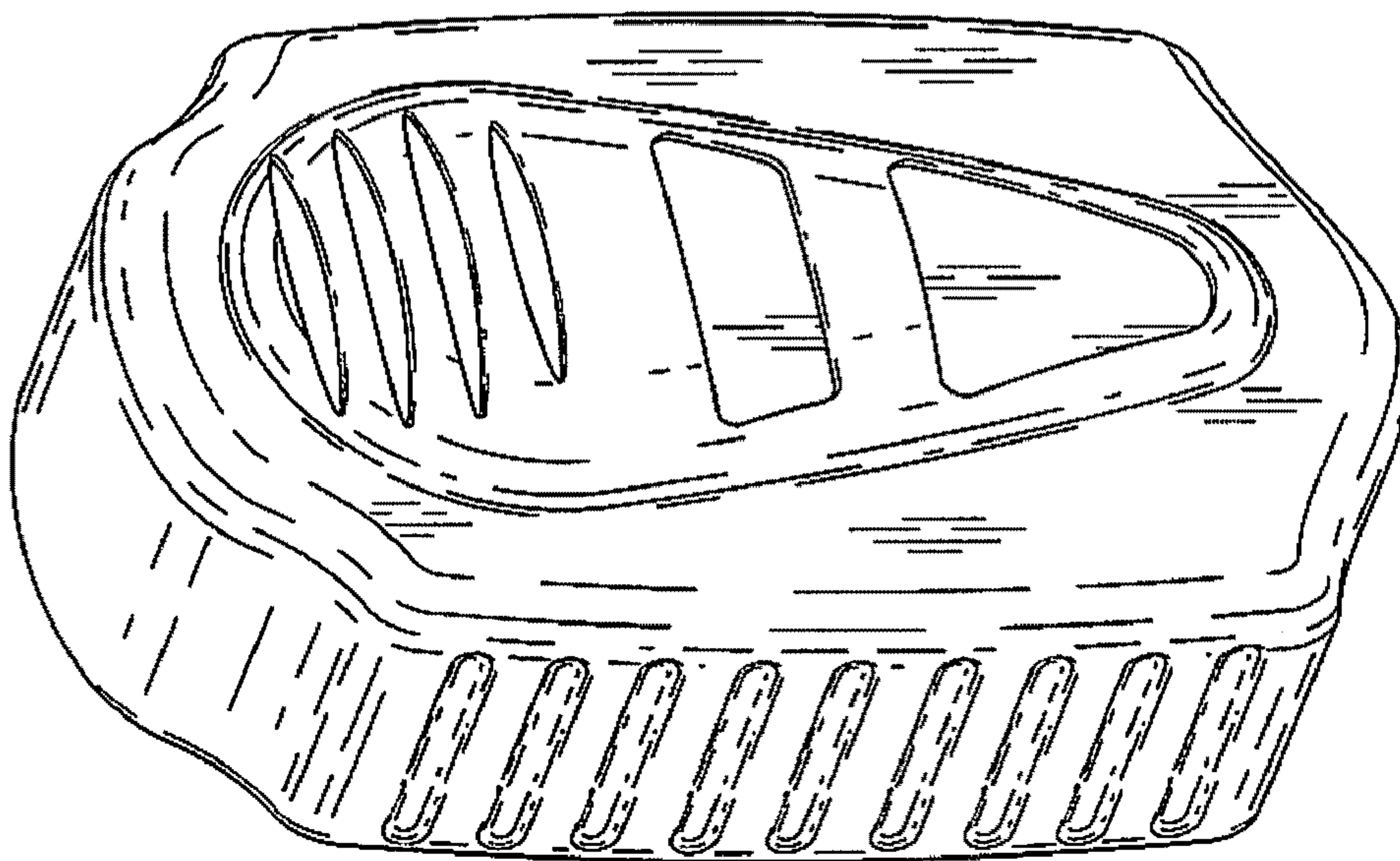

Fig. 1

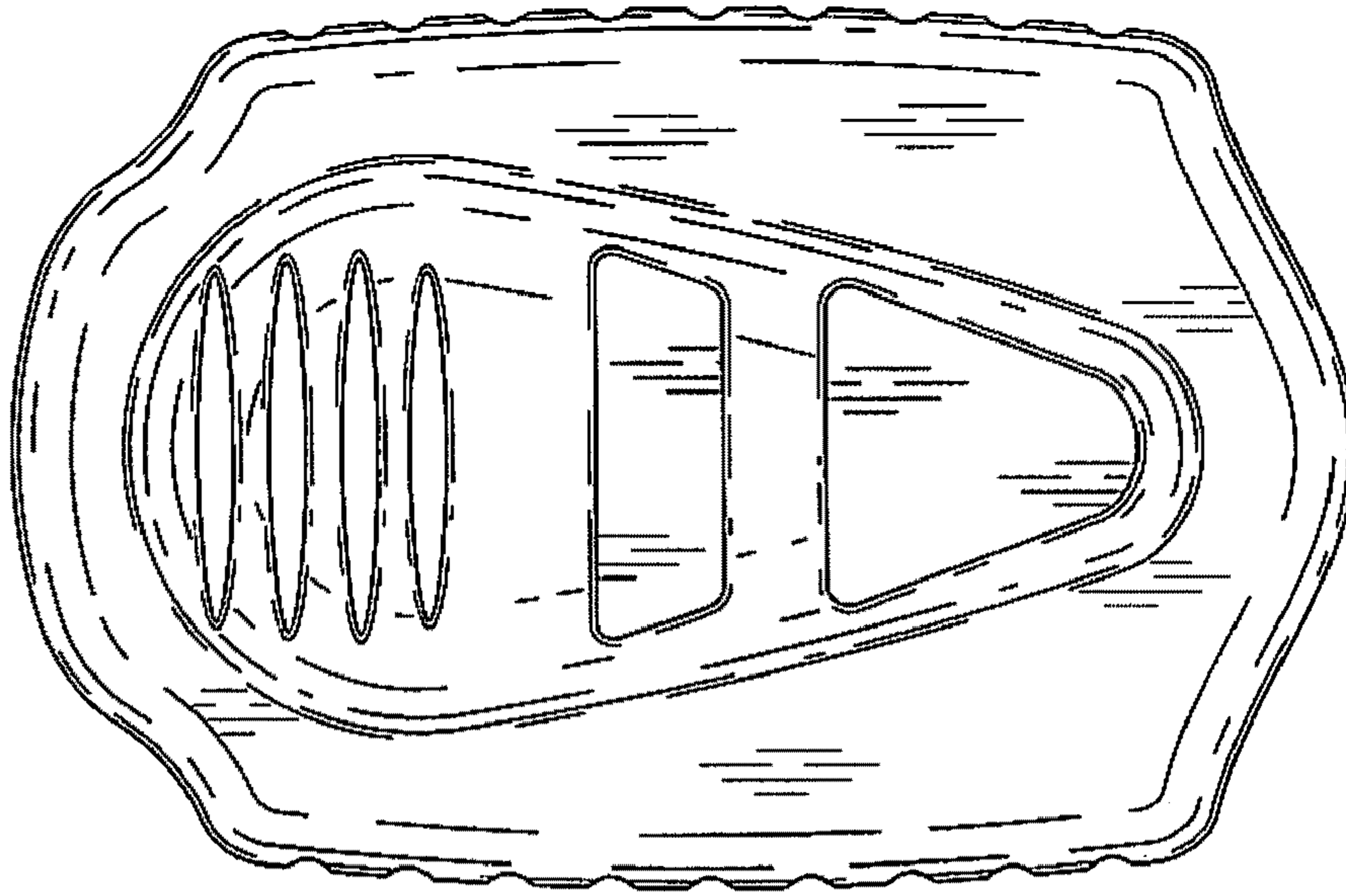

Fig. 2

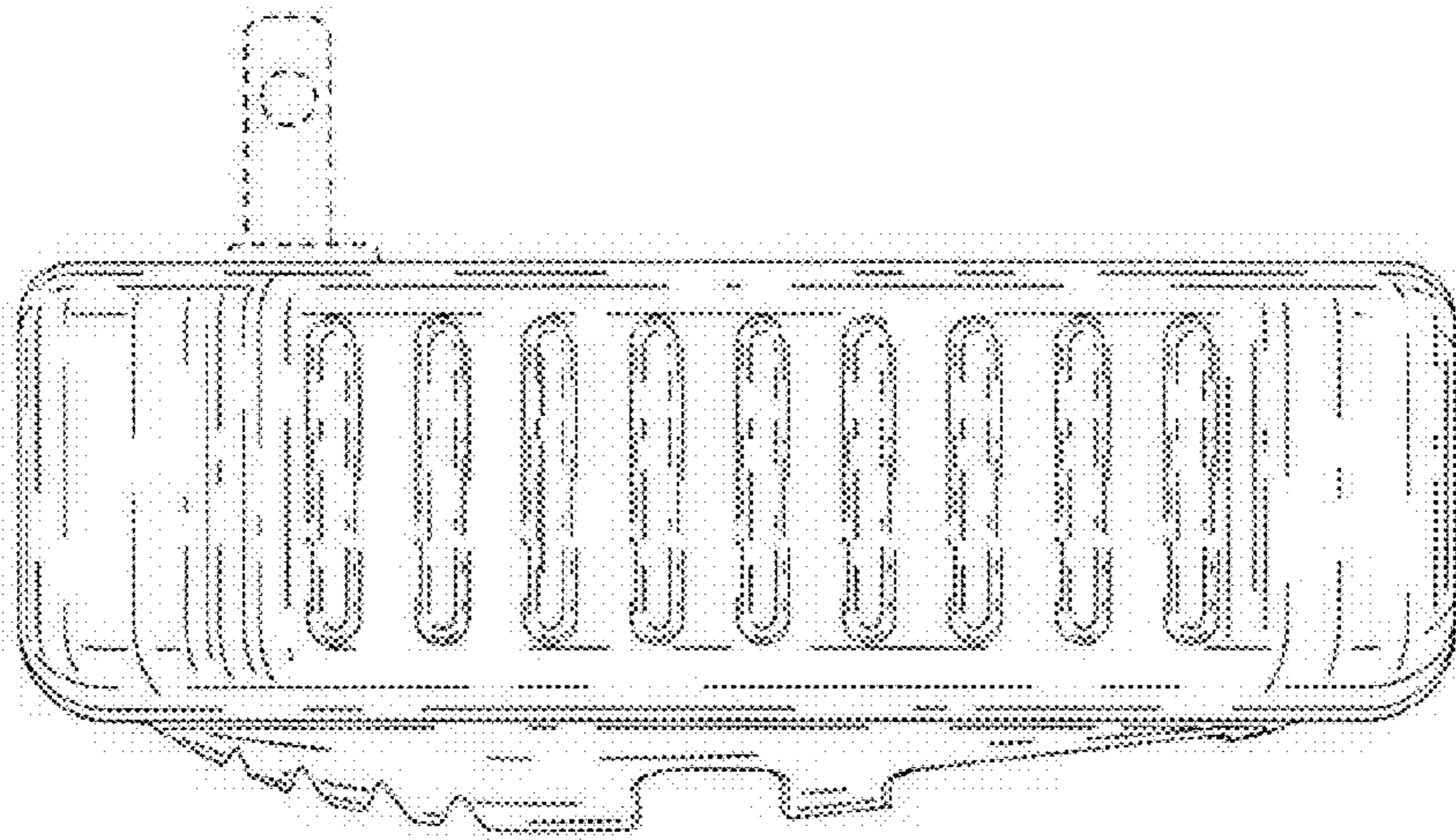

Fig. 5

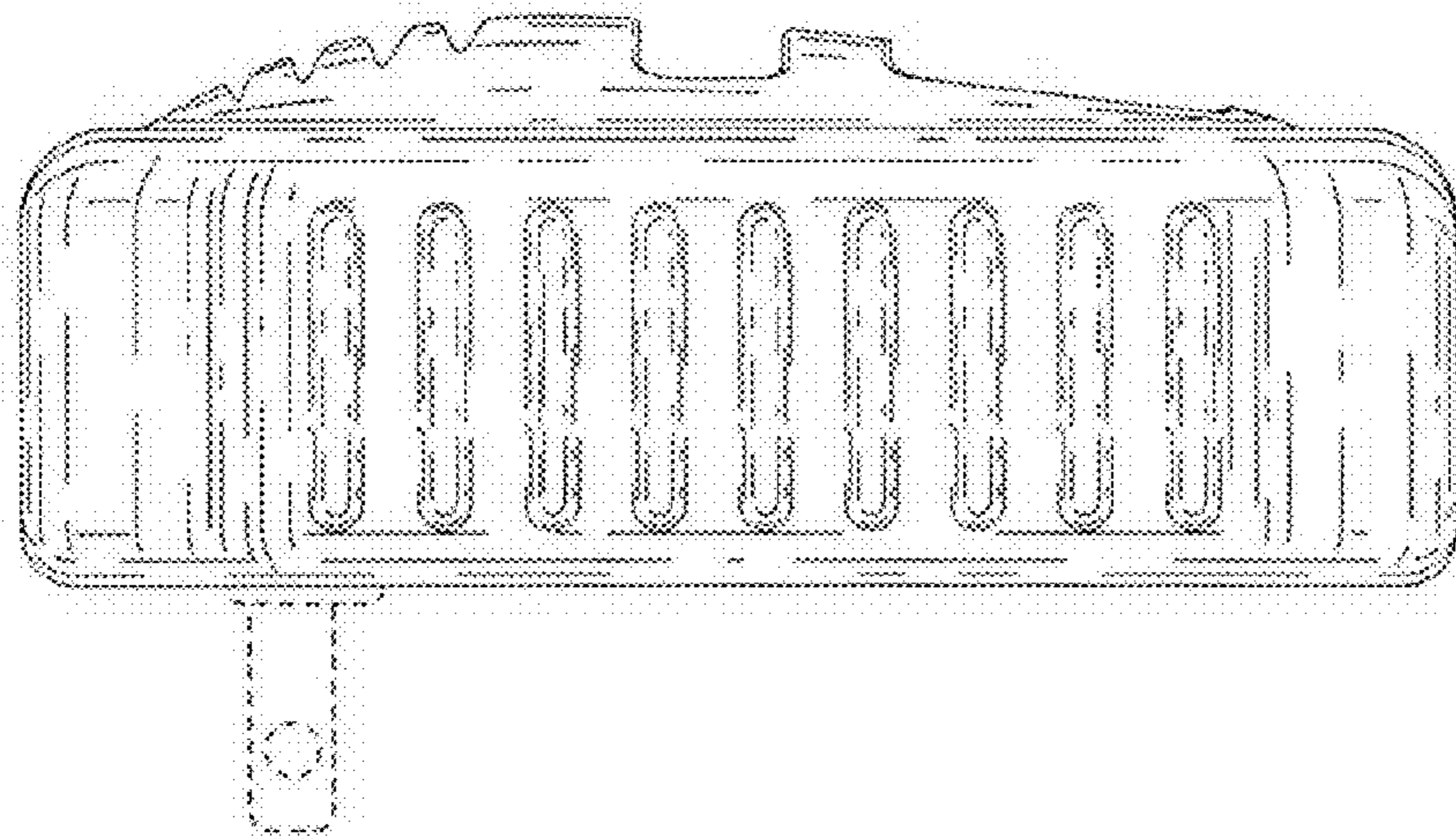

Fig. 4

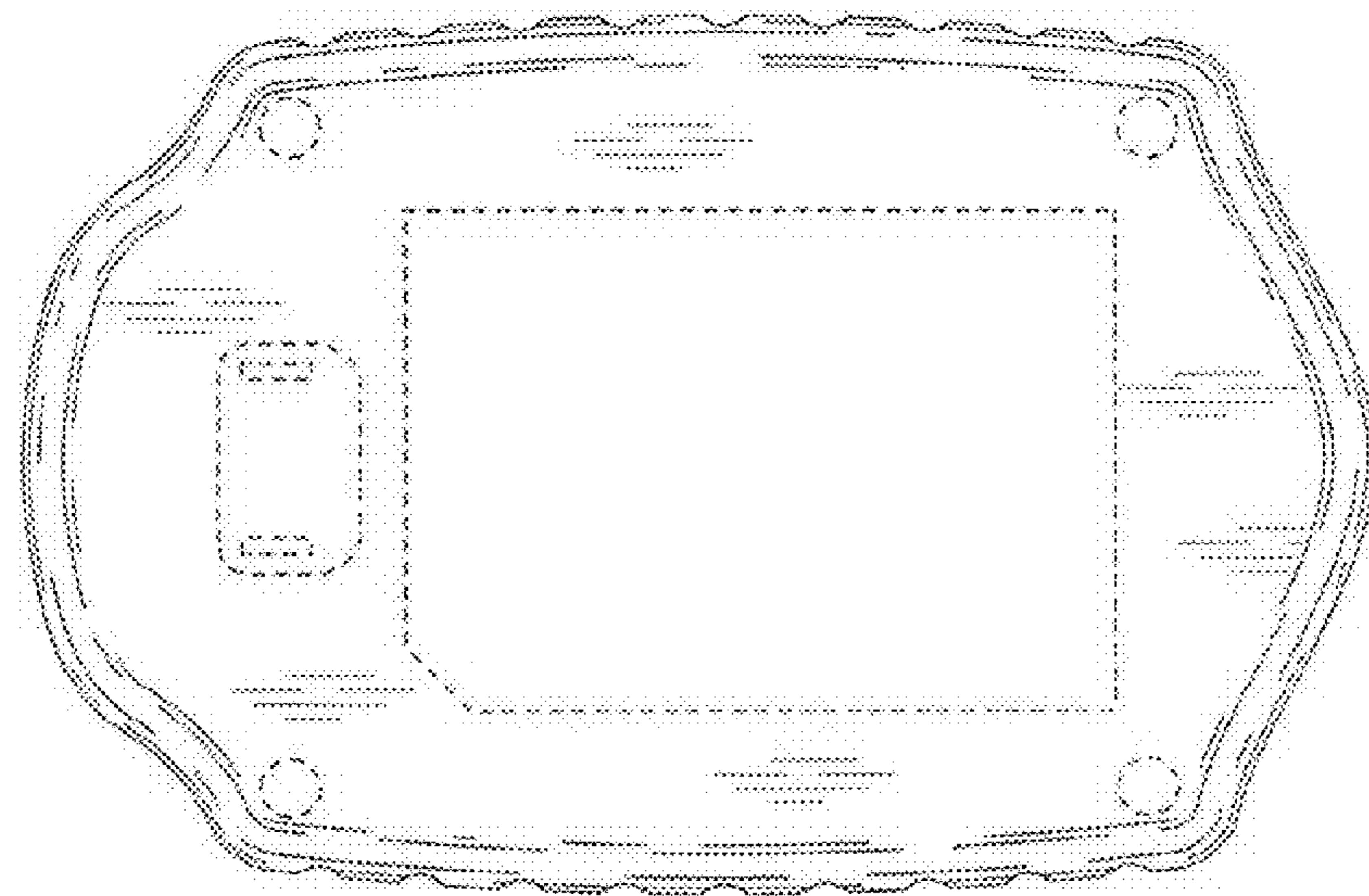

Fig. 3

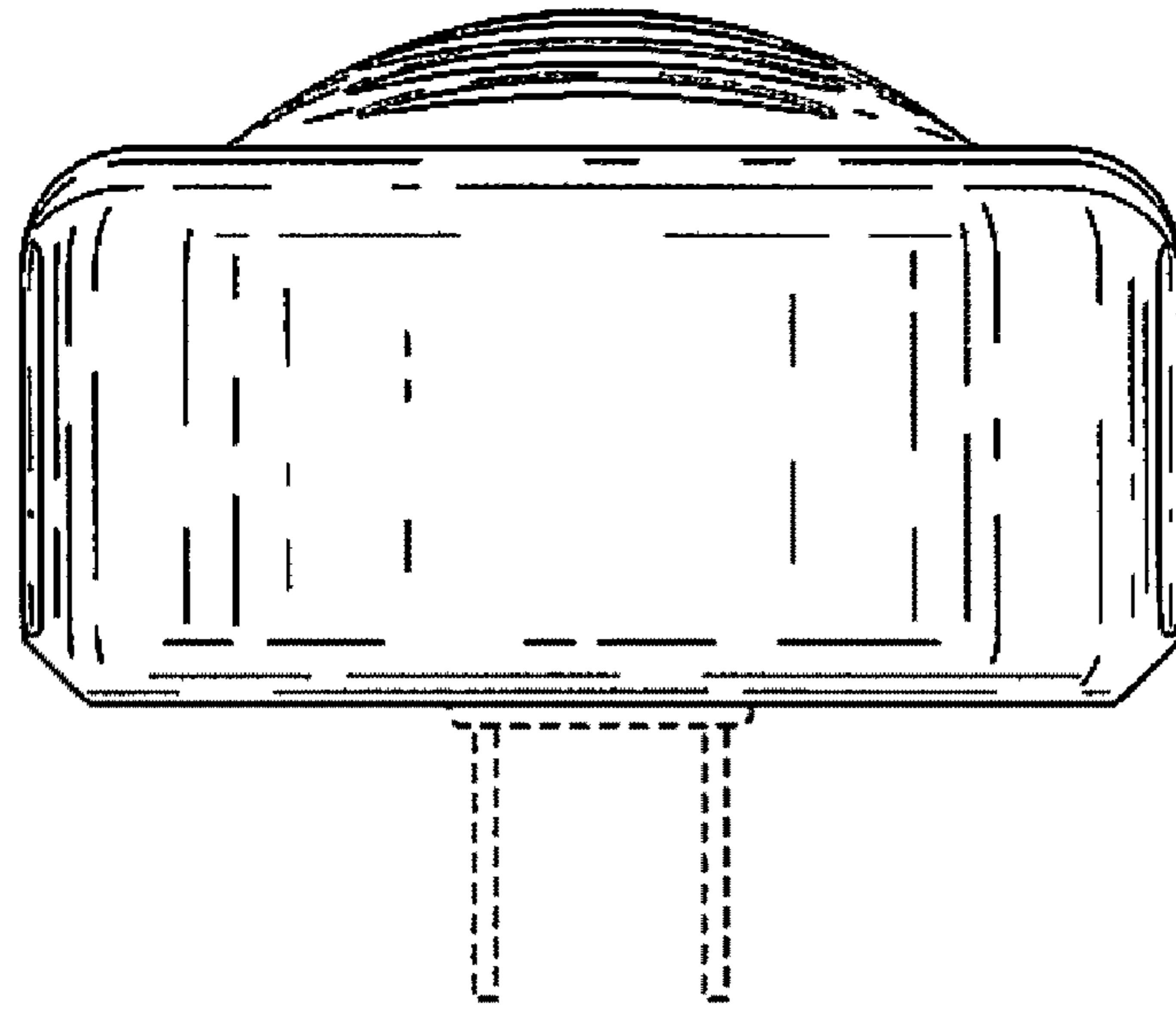

Fig. 6

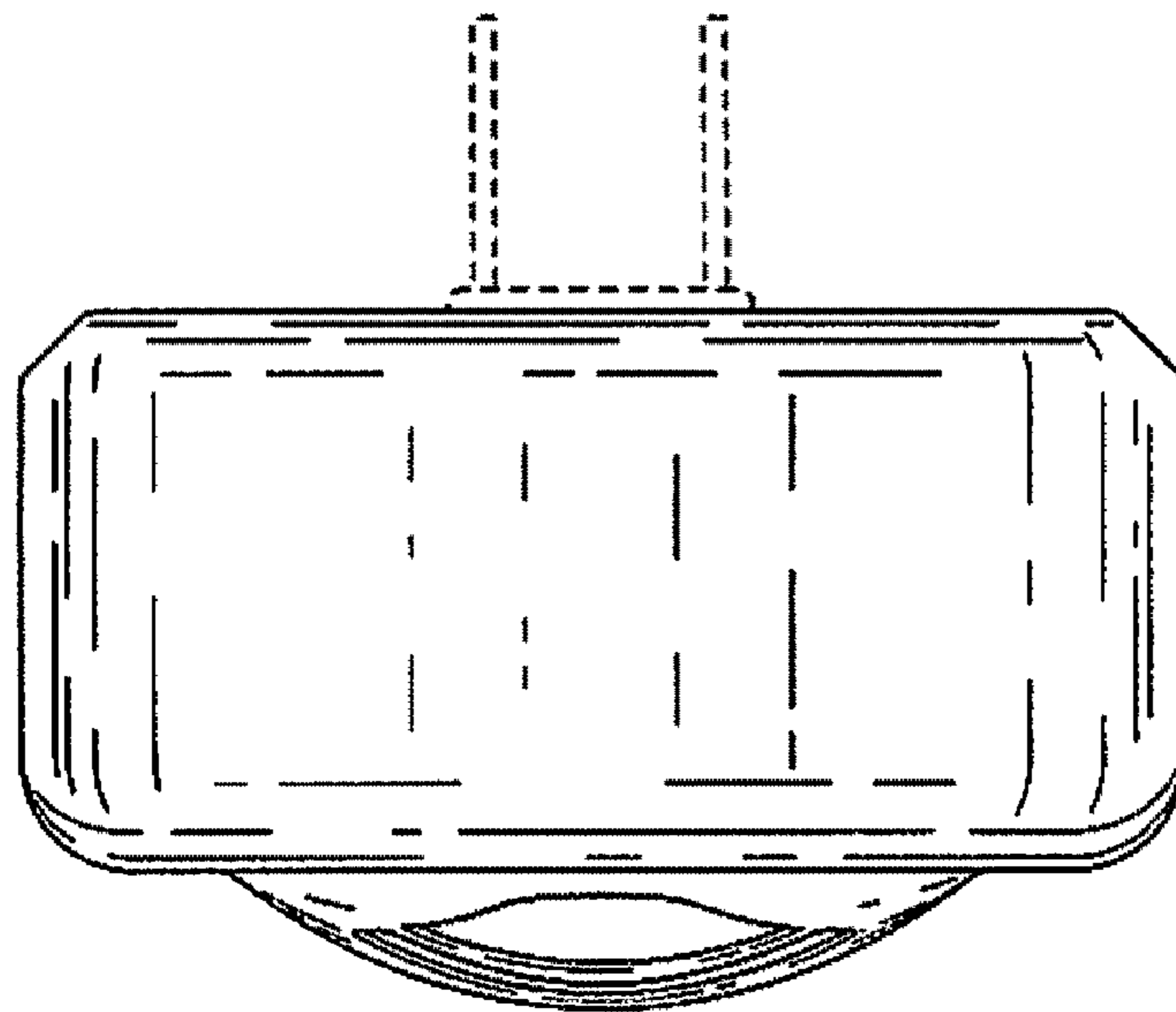

Fig. 7